

<p>1</p> 	<p>2</p> 	<p>3</p> 
<p>4</p> 	<p>5</p> 	<p>6</p> 
<p>7</p> 	<p>8</p> 	<p>9</p> 
<p>10</p> 	<p>11</p> 	<p>12</p> 
<p>13</p> 	<p>14</p> 	<p>15</p> 
<p>16</p> 	<p>17</p> 	<p>18</p> 

19

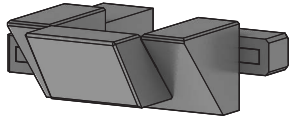

20

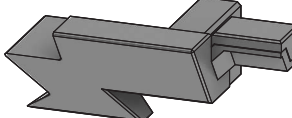
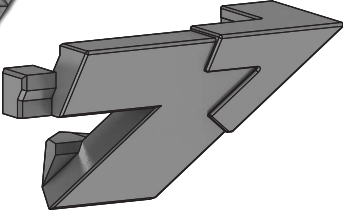
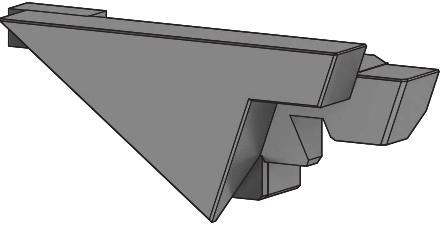
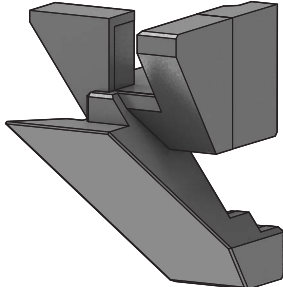
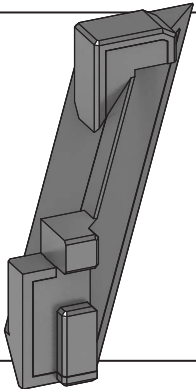
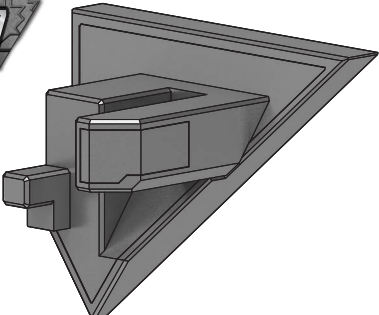
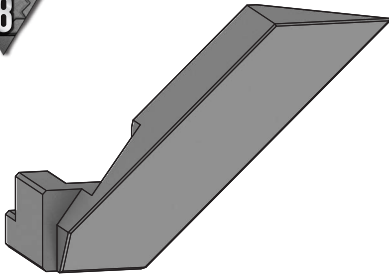
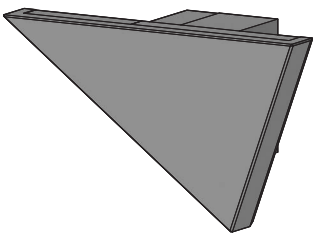
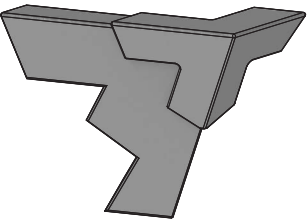
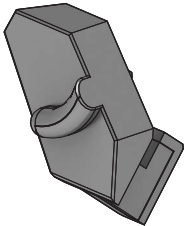
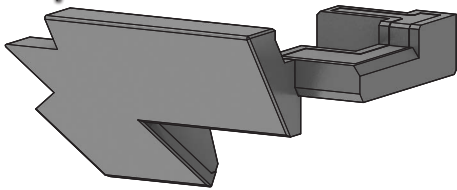
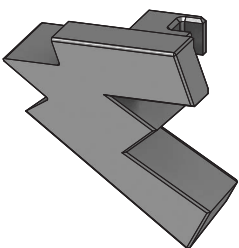
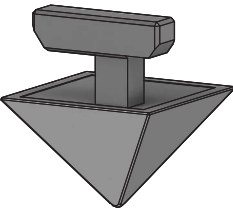
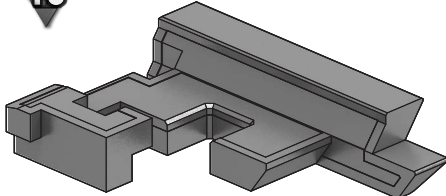
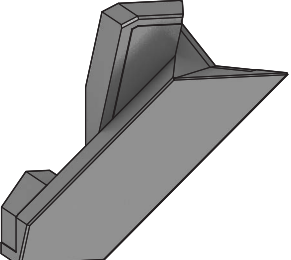
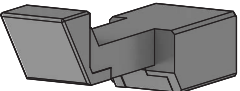
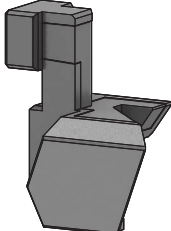
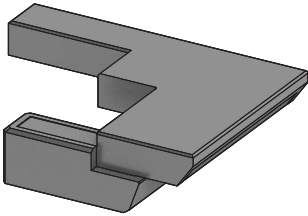
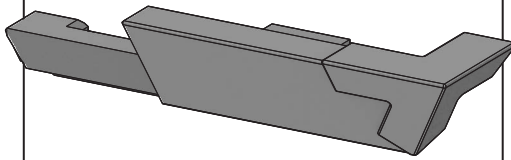

21

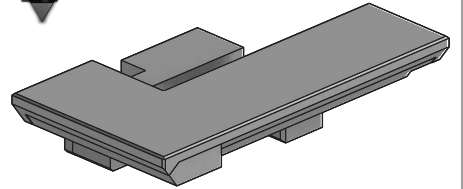

22

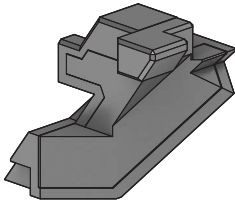

23

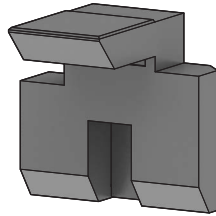

24

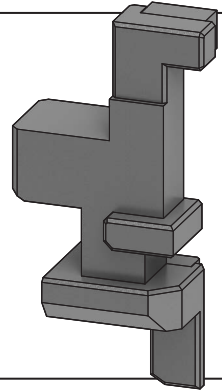

25

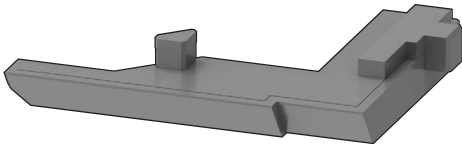

26

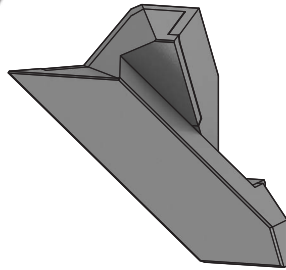

27

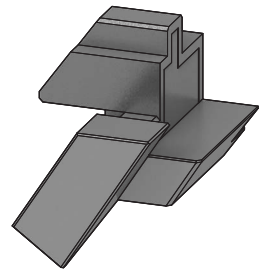

28

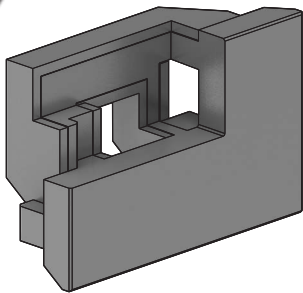

29

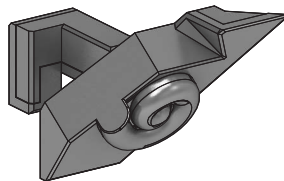

30

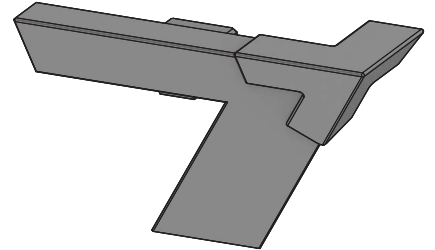

31

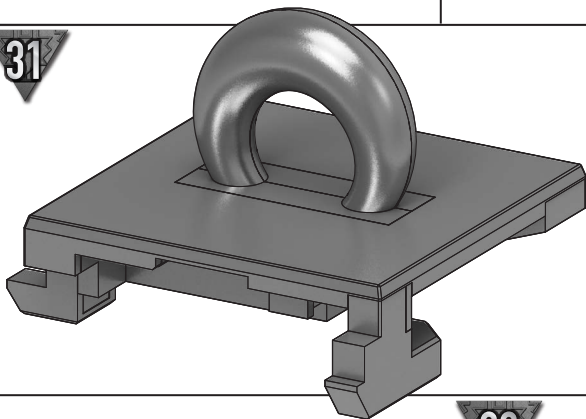

32

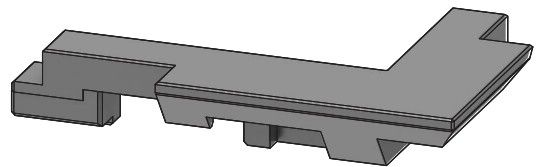

33

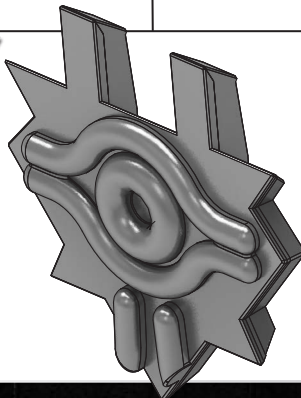

ULTIMAGEAR  
MILLENNIUM PUZZLE  
ULTIMAGEAR 千年パズル

組み立てたピースは  
なくさないように  
気をつけましょう。  
Be careful not to lose  
any of the pieces  
you have assembled.