

Exploiting Partially Overlapping Channels in Wireless Networks: Turning a Peril into an Advantage

Arunesh Mishra ^α, Eric Rozner ^β, Suman Banerjee ^β, William Arbaugh ^α
^α *University of Maryland, College Park.* ^β *University of Wisconsin, Madison.*

Abstract

Interference has always been considered as an unavoidable peril in wireless networks. A single data transmission is useful to some nodes and becomes interference to others. Based on channel of origin, interference can be categorized into co-channel (from transmissions on the same channel as the receiver) and adjacent-channel (transmissions on adjacent and overlapping channels).

In this paper, we define specific mechanisms that can transform partially overlapped channels into an advantage, instead of a peril. We construct simple analytical and empirical models of such interference occurring in IEEE 802.11 networks, and illustrate two scenarios where such interference can be exploited. First, we apply partially overlapping channels to improve spatial channel re-use in Wireless LANs (WLANs). Second, we leverage such channels to enable nodes with a single radio interface to communicate more efficiently with their peers in 802.11 ad-hoc mode potentially using multi-hop paths. We evaluate both capabilities through testbed measurements.

1 Introduction

The IEEE 802.11 b/g standards operate in the unlicensed ISM 2.4 Ghz spectrum which has 11 out of 14 channels available for use in the US. The channel number (1...11) represents the center frequency on which the radios operate (e.g. 2.412 Ghz for channel 1). The center frequencies are separated by 5 MHz, while the channels have a spread of about 30 MHz around the center frequency. As a result, a signal on any 802.11b channel overlaps with several adjacent channels, with the *extent* of overlap decreasing with increasing separation between the center frequencies. Attributing to this overlap, a transmission on one channel becomes interference to stations on an overlapping channel, also known as adjacent channel interference.

The term adjacent channel interference can be contrasted to co-channel interference which occurs from transmissions on the same channel. In 802.11 and other wireless networks, adjacent channel interference is considered a peril. In order to avoid this peril, two simultaneously communicating nodes that are in close proximity are assigned to different non-overlapping chan-

nels, i.e., channels 1, 6, and 11 in 802.11b are non-overlapping. For example, in a inbuilding WLAN with multiple APs, interfering APs are assigned to different non-overlapping channels. Traditionally, in the literature on channel assignment algorithms, the notion of availability of a set of N channels has inherently implied that they are non-overlapping. This is why the number of available channels in 802.11b networks is considered to be three. However, many channel pairs in the ISM band overlap partially. Given that wireless spectrum is a scarce resource, in this paper we discuss the basic concepts behind building techniques to carefully exploit the partially-overlapped nature of channels for efficient spectrum management.

Consider a simple experiment where a transmitting station is placed on channel 6, and a receiving station is moved from channel 1 through 11. The two stations are placed in close proximity to each other to preclude effects of signal attenuation due to distance. Table 1 shows the signal-to-noise ratio (SNR) of the received signal on channels 1...11. The SNR is normalized to a scale of 0...1 with 1 denoting the maximum signal received and 0 the minimum (indicating background noise level). We can see that the interference between channels 1 and 6, and channels 6 and 11 is minimum – hence they are considered non-overlapping. However, there exist other channel pairs (eg:- (2, 6) and (6, 10)) where the interference is fairly low.

We define a term *Interference-factor* or simply *I-factor* denoted by $I(i, j)$ as the *extent* of overlap between channels i and j . If P_i denotes the power received at a given location of a particular signal, and P_j denote the power received of the same signal at the same location on channel j , then $I(i, j)$ is defined as $\frac{P_i}{P_j}$. $I(i, j)$ gives the fraction of a signal's power on channel j that will be received on channel i . Table 1 thus shows $I(i, 6)$ normalized to a scale of 0...1. I-factor can be calculated analytically as well as empirically and does not depend on the radio propagation properties of the environment (i.e. open space or indoors). It depends on the extent of frequency overlap between the signals on channels i and j .

We believe that ours is the first systematic effort on taking advantage of partial overlap among channels in two different settings — WLANs and mesh networks. Each scenario illustrates a novel conceptual notion of ex-

Channel	1	2	3	4	5	6	7	8	9	10	11
Normalized SNR (I-factor)	0	0.22	0.60	0.72	0.77	1.0	0.96	0.77	0.66	0.39	0

Table 1: Table shows the signal-to-noise ratio (SNR) normalized to a scale of 0 . . . 1 of the transmission made on channel 6 as received on channels 1 . . . 11. We call this quantity *I-factor*.

exploiting the overlap among channels. To achieve some desired benefits we will leverage the following two observations. 1) As shown in Table 1 partial overlap among two channels reduces the signal strength of a transmission on one channel as received on the other (when compared to using the *same* channel). This improves the *spatial re-use* of channels which refers to how frequently a single channel can be re-used without interference. 2) Partially overlapped channels will allow communication between two nodes operating on non-overlapped channels, by forwarding traffic among them. We describe the two settings next.

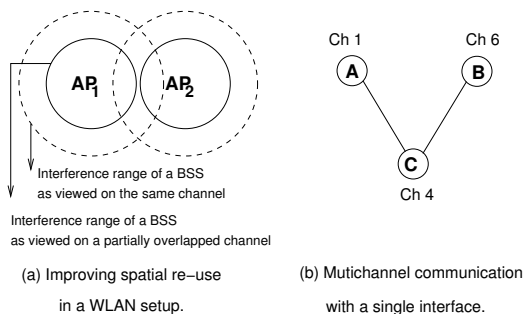

Figure 1: Two advantages of using partial overlapping channels in wireless networks.

WLAN scenario: In a WLAN, an AP and its associated clients which form a basic service set (BSS), communicate on a single channel. Two APs can operate on the same channel as long as they do not interfere with each other. Better spatial re-use of channels brings about improvement in the network’s throughput capacity as a whole [9]. Specifically in a WLAN, this allows the placement of more APs without interference and thus providing better service to an increased number of clients.

Neighboring APs in a WLAN are typically spaced sufficiently far apart so as to maximize the region of coverage while allowing some overlap for handoffs to occur smoothly. Figure 1(a) shows two APs and the interference range of their BSS which is the distance upto which transmission from the AP or an associated client would interfere (circular ranges for illustration only). Here these APs will have to be assigned to non-overlapping channels, or the APs will have to be spaced further apart to allow them to operate on the same channel. Instead of assigning them to non-overlapping channels, one can assign them partially overlapping channels such that the signal attenuation due to the partial overlap makes the in-

terference negligible (i.e. the signal strength degrades to a tolerable level). Conceptually, this can be thought of as reduction in the interference range of an AP’s BSS as viewed by a receiver on an adjacent overlapping channel. The reduction in the interference range increases with increased separation among the channels, with complete reduction perceived over non-overlapping channels.

It may appear that similar reduction in BSS size can be achieved by reducing transmission power of the APs. Unfortunately such a change does not lead to the same level of spectral use for two reasons. 1) Although by reducing transmission powers in 802.11b networks APs can be brought as close to each other as in the adjacent channel case, the number of channels that can be utilized is still three (and not four). 2) Reduction in transmission power reduces the signal to noise ratio in the AP-client interaction and adversely affects performance for clients. Hence, by exploiting adjacent channel interference we can get much better performance than by just reducing transmission power at APs. We evaluate this effect over TCP/UDP throughputs and MAC level collisions as measured in testbed environments in Section 3.

Mesh networks scenario: Consider a very simple mesh network setting with three nodes each having just one radio interface (Figure 1(b)). In general, if node A wants to communicate with node B, both these nodes need to use the same channel. However, let us assume that due to assignment of channels to other neighboring nodes, A and B need to be assigned to channels 1 and 6 respectively. However, if node C can be assigned to channel 4, then there are partial overlap between channels assigned to A and C as well as between B and C. Hence C can route traffic from A to B, using the partially overlapping properties of channels. Such opportunistic mechanisms can have non-trivial impact on the routing system used by the mesh network. In general, mesh network nodes where the number of interfaces available is less than the number of non-overlapping channels provided by the physical layer (such as 12 in 802.11a) can utilize such optimizations to communicate with nodes on multiple channels providing increased flexibility to the routing infrastructure used by the network. We evaluate this using experiments in Section 4. Next section presents the analytical basis behind spatial re-use.

2 Analytical Basis behind Spatial Re-use

We develop analytical reasoning behind using partially overlapping channels to improve spatial re-use of spec-

trum. We borrow some of the terminology used in [10] for the discussion below.

For the simplicity of discussion, we will assume an open-space environment, in which the path loss of a signal is usually modeled by a two-ray ground propagation model [7]. Let d be the distance between the receiver and the transmitter. According to this model, in the *open space* environment, the received power P_r of a signal from a sender at distance d is given by

$$P_r = P_t G_t G_r \frac{h_t^2 h_r^2}{d^k} \quad (1)$$

In Equation 1, G_t and G_r are the antenna gains of the transmitter and the receiver respectively. h_t and h_r are the height of both antennas. P_t is the transmission power at the sender. The path loss, parameter k , typically is a value between 2 and 4.

A signal arriving at a receiver can be demodulated correctly if the *signal-to-noise ratio* (SNR) is above a certain threshold (say T_{SNR}). Say, a transmitter T and receiver R are separated by distance d , while another sender S (potentially causing interference) is at a distance r from the receiver R and on the same channel. Let P_d denote the receiving power of the signal from the transmitter T, and P_r the power of the signal from S at R. Thus, the SNR is given as $SNR = \frac{P_d}{P_r + N_a}$, where N_a is the ambient or thermal noise in the environment around the receiver R. For simplicity of analysis, we neglect N_a compared to P_r , and assume homogeneous radios. We have,

$$SNR = P_d/P_r = \left(\frac{r}{d}\right)^k \geq T_{SNR} \quad (2)$$

$$r \geq \sqrt[k]{T_{SNR}} \cdot d \quad (3)$$

Thus, to successfully receive a signal, the interfering nodes must be at least $\sqrt[k]{T_{SNR}} \cdot d$ distance away from the receiver.

Now, if T and R were on channel i and the sender was on channel j , the minimum separation between S and R would become $\sqrt[k]{T_{SNR} I(i, j)} \cdot d$, where $I(i, j)$ denotes the I-factor (see Table 1) as defined in Section 1. Note that since $I(i, j) \leq 1$, this new distance is less than $\sqrt[k]{T_{SNR}} \cdot d$, thus allowing the stations to get closer without incurring interference. This improves the spatial re-use of the wireless spectrum. We show how this concept can improve channel assignment in WLANs next.

3 Channel Assignment in WLANs

Channel assignment to APs in a wireless LAN is typically performed statically by the network administrators after performing an RF site survey, or autonomously by the APs performing a “least congested channel search (LCCS)”, i.e., identifying a channel which has low interference. Both approaches have been shown to have

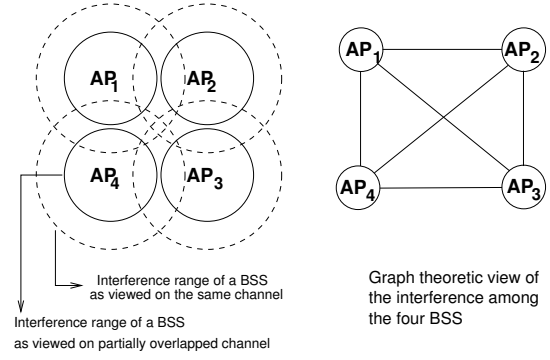

Figure 2: Improving spatial re-use of spectrum with partially overlapping channels in a WLAN environment.

a number of inefficiencies, and other dynamic and distributed approaches have been proposed [4, 5]. Here we show using a simple example how partially overlapping channels can yield improved network throughput and can be complementary to existing channel assignment methods.

Consider the WLAN setup shown in Figure 2. The dashed circle shows the size of an AP’s cell or the basic service set (BSS). This region is the distance upto which a transmission from either the AP or a client associated to the AP would interfere with stations on the same channel as the AP (circular ranges for ease of illustration). There are four APs whose BSS have reasonable overlap. Network administrators would organize APs in this manner so as to maximize total coverage while allowing reasonable overlap for handoffs to occur. If there are large number of clients in the common region of overlap, the four APs would need to be assigned to different channels. Such constraints are typically captured in a graph theoretic manner as shown in the figure, and channel assignment becomes the well-known graph coloring problem. The example of Figure 2 becomes a 4-clique, which needs four channels to eliminate interference from neighboring APs. This is impossible to achieve in the 802.11b system, which has only 3 non-overlapping channels.

Instead of using 3 non-overlapping channels, the APs could use partially-overlapped channels, e.g., 1, 4, 7 and 11. The partial overlap among these channels would be sufficient to degrade the signal below an acceptable level so as to not cause interference. This is conceptually viewed as reducing the interference range of a BSS by a certain factor as observed by a receiver on a neighboring channel – the *extent* of overlap among two channels which we defined as the *I-factor*. Note that the range of a BSS itself (as viewed in the same channel) is not altered. Hence clients associated with this AP see no difference in performance, while clients of neighboring APs on partially overlapped channels see reduced interference. Thus, by using these four partially overlapping

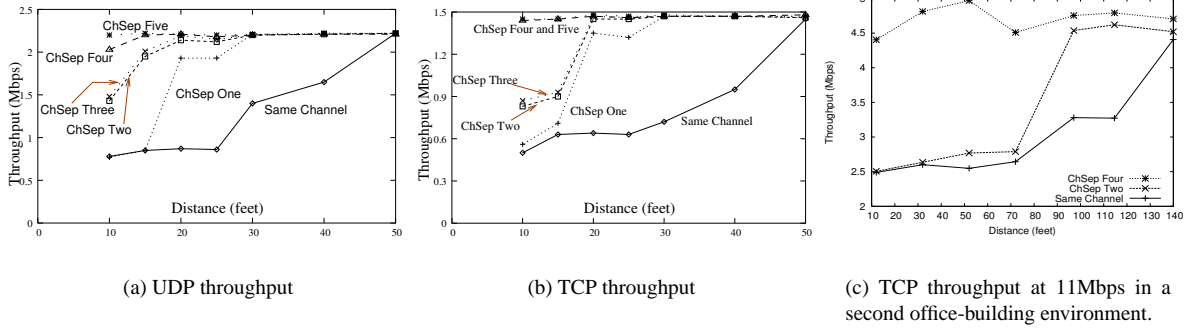

Figure 3: TCP/UDP throughputs versus spatial separation (*ChSep*).

channels, the respective BSS get rid of any interference from neighboring APs

Below we discuss a systematic method for taking advantage of the partially overlapping channels in an algorithmic manner. We note that at this point this is work-in-progress as we work towards a full-fledged solution:

Let k denote the total number of non-overlapping channels available in the underlying wireless PHY layer. Given a region of interest covered with a set of access points, define an *overlap graph* $G = (V, E)$ as follows: $V = \{ap_1, ap_2, \dots, ap_n\}$ be the set of n APs that form the network. Place an edge between APs ap_i and ap_j ($ap_i \neq ap_j$) if the users associated to the respective APs or the APs themselves interfere (indicating spatial overlap in region of coverage).

Assume we are given a channel assignment that uses the 3 non-overlapping channels in 802.11b. This assignment could have been performed using LCCS or other techniques [5]. Reflect the channel assignment onto the above constructed overlap graph. We say that an edge (ap_i, ap_j) is a *conflict edge* if there is interference between the respective APs – i.e. they are assigned the same channel. Consider such a conflict edge (ap_i, ap_j) . Note that both ap_i and ap_j , have neighbors utilizing the other two channels (else this conflict can be removed). Now, we apply the partially overlapping channels to this subgraph formed by ap_i, ap_j and all neighbors of ap_i and ap_j , we observe if the partial overlap can reduce the interference (as discussed in the example above). This intuition can be used to algorithmically use partially overlapping channels.

Next, we discuss detailed experimental results which show improved spatial reuse of spectrum using partially overlapping channels.

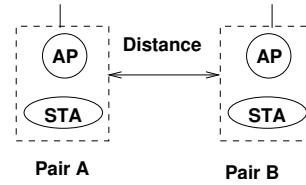

Figure 4: The experimental setup used.

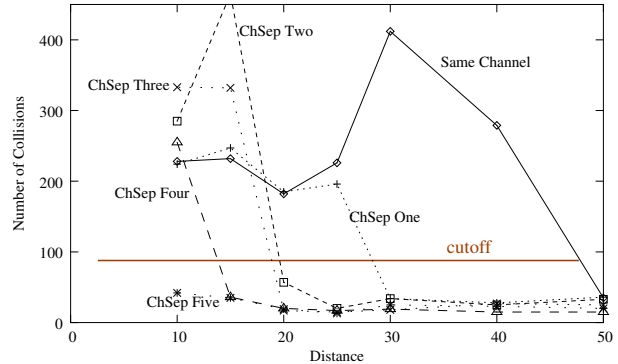

Figure 5: Number of collisions versus spatial separation.

3.1 Experiments to demonstrate spatial reuse

To demonstrate how partially overlapping channels can be used to improve reuse of the RF spectrum, we consider the following setup. Two APs and two stations (STA), with one STA associated to each AP, take part in the experiments. One such AP-STA pair, called *Pair-A*, is kept fixed at a particular location within an office building, while the other *Pair-B* is moved to various different locations of measurement. The distance between an AP and its associated STA is kept constant throughout the experiment process.

The following parameters are varied to study the effect of using partially overlapping channels on TCP/UDP throughput and MAC level collisions: The distance between the AP-STA pairs is varied to study the interfer-

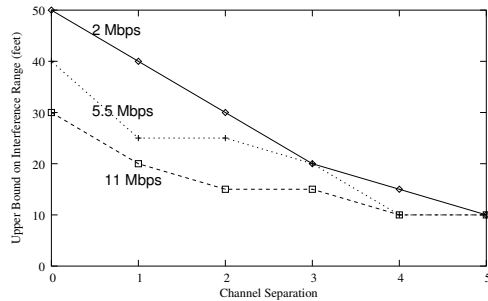

Figure 6: Interference ranges vs channel separation for datarates of 2, 5.5 and 11 Mbps.

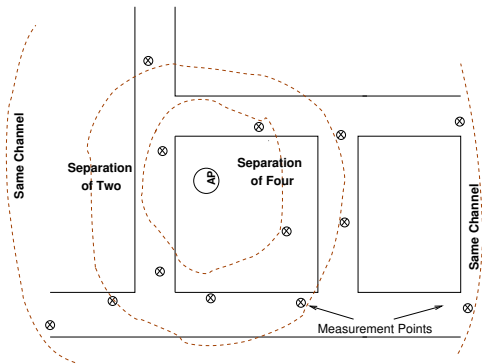

Figure 7: Measurement setup used along with interference ranges at channel separation of 0 (same channel), 2 and 4.

ence range of the BSS formed by the pair. The datarate used for communication was chosen from the following permissible instantaneous data rates: 2, 5.5 and 11 Mbps (note, throughputs will be lower). The channel separation, which refers to the difference in the channel numbers used by the two pairs, is varied between 0 and 5. For each selection of the parameters, we monitored TCP and UDP throughputs for flows lasting 10 seconds. The MAC level collisions were also monitored. All APs and STAs used wireless NICs from the same vendor with a constant transmit power of 30mW.

Figure 3(a) plots the UDP throughput achieved by the AP-STA Pair-B against distance from Pair-A. This experiment used a datarate of 2 Mbps which best shows how a step by step decrease in overlap increases the AP-STA throughput (other datarates omitted due to space restrictions). Figure shows that using the same channel, a distance of around 50 feet would be necessary to eliminate the interference and attain the maximum possible throughput. This throughput is attained for much smaller distances as the channel separation (indicated by the legend *ChSep*) is increased from 0 (same channel) to 5 (non-overlapping channels). Figure 3(b) shows the same effect on TCP throughput. Figure 3(c) shows the TCP throughput in a second environment, which is an office

building with a long corridor on which the experiments were performed. The datarate here was set at 11 Mbps.

Figure 5 shows the number of collisions that occurred at the AP-STA Pair-B. The number of collisions have a significant amount of variation from one execution of the experiment to another because of the randomness present in the MAC protocol. However, clearly noticeable is the fact that a drastic reduction in the number of collisions (as shown by the *cutoff* at around 100 in Figure 5) indicates significant reduction in interference. Thus, the points at which each curve takes a plunge below the *cutoff* line (shown in the figure) indicates the distance at which interference does not occur between the two AP-STA pairs.

Figure 6 shows the effect of the 802.11 MAC datarate on the interference range of a BSS. Each point on a curve plots the minimum observed distance (modulo discrete observation points) on the y-axis at which with the given channel separation (x-axis) the two AP-STA pairs do not interfere with each other and attain the maximum possible TCP/UDP throughput – which is the interference range of the BSS formed by an AP-STA pair. One observes that for all three datarates, the interference range decreases consistently. Also as expected, for a given amount of channel overlap, a higher datarate has a smaller interference range.

Figure 7 shows graphically the interference ranges for channel separation of zero (same channel), 2 and 4 at a datarate of 2 Mbps. This visually demonstrates how spatial reuse can be significantly improved by carefully employing partially overlapping channels.

4 Applications to Mesh Networks

Proper channel assignment and routing are important to utilize the full capacity of a mesh network. Channel assignment affects the topology that is available to the routing infrastructure and these problems are addressed in tandem with each other [6, 2, 8, 3]. Also, there are techniques which utilizes a single wireless card to connect to multiple networks by constantly switching channels [1]. Partially overlapping channels that allow communication with nodes operating on different non-overlapping channels can yield significant advantages in such settings. They can be employed to connect to multiple networks, or to add flexibility to the routing infrastructure by creating additional edges in the mesh network topology. Below we demonstrate simple experiments which show how two nodes operating on partially overlapping channels can communicate with each other.

We conduct the following simple experiment: Two nodes are placed on channels with decreasing overlap, and the UDP throughput is measured. One node was kept fixed on channel 6, while the other was progressively moved from channel 1 through 11. The nodes were con-

figured at a datarate of 2Mbps. Figure 8 shows the plots at distances of 15 and 30 feet between the two nodes. The plots demonstrate how a partially overlapping channels can be used to communicate at the cost of reduction in the throughput. This allows a node with a single interface to communicate with nodes on two non-overlapping channels by operating on a channel that partially overlaps with both.

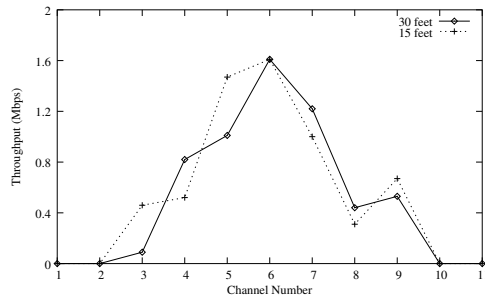

Figure 8: Throughput versus channel separation.

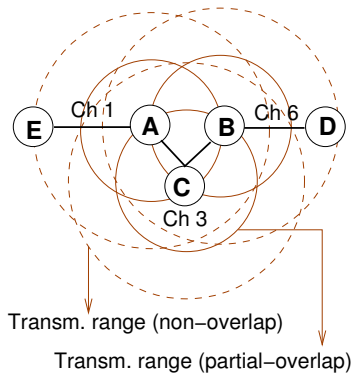

Figure 9: Example multihop scenario.

Throughput improvements using partially overlapping channels: Apart from utilizing partially overlapping channels for topology flexibility in mesh settings, they can be applied to improve the throughput capacity of multi-hop networks. Consider the multihop setup shown in Figure 9. There are four nodes; each with a single radio interface. Because of this limitation, technically the network can utilize only one channel or the network would get partitioned. Say, nodes A, B and C are within communication range of each other. Nodes D and E are each within communication range of nodes A,B and C. The transmission ranges of nodes A,B and C are shown using dashed circles. With all nodes operating on a single channel to prevent network partition, each node shares the channel with two other nodes, thus achieving roughly 1/3rd of the maximum available bandwidth on one channel.

Now, using partially overlapping channels, an assignment can be performed as follows. Nodes A and E are

assigned channel 1; nodes B and D are on channel 6. These links do not interfere with each other. Node C is placed on channel 4, which allows communication with both A and B. Channel 4 is chosen such that the reduction in the communication range as determined by the extent of overlap between $\langle 4, 6 \rangle$ and $\langle 4, 1 \rangle$ allows communication with both A and B. The network thus utilizes the maximum bandwidth available on two non-overlapping channels and hence this can result in significant throughput improvements.

5 Summary

Through testbed measurements we have evaluated how partial overlap in channels can be exploited for improved spatial re-use (WLANs) and the ability to do multi-channel communication (Mesh). The focus of this paper has really been to add a new mechanism to our toolkit for spectrum management — partially overlapped channels. We believe this paper is merely the first step towards design of new and efficient algorithms that are aware of the potential demonstrated. In particular it would be possible to re-visit each channel assignment technique designed in the past and examine how they can be extended by employing this new mechanism.

References

- [1] CHANDRA, R., BAHL, P., AND BAHL, P. Multinet: Connecting to multiple ieee 802.11 networks using a single wireless card. In *Proceedings of IEEE Infocom* (2004).
- [2] DRAVES, R., PADHYE, J., AND ZILL, B. Routing in multi-radio, multi-hop wireless mesh networks. In *Proceedings of ACM Mobicom* (2004).
- [3] KYASANUR, P., AND VAIDYA, N. Routing and interface assignment in multi-channel multi-interface wireless networks. In *Proceedings of IEEE WCNC* (2004).
- [4] LEE, Y., KIM, K., AND CHOI, Y. Optimization of ap placement and channel assignment in wireless lans. In *Proceedings of 27th Annual IEEE Conference on Local Computer Networks (LCN)* (2002).
- [5] MISHRA, A., BANERJEE, S., AND ARBAUGH, W. Weighted coloring based channel assignment for wlans. *ACM SIGMOBILE Mobile Computer Communications Review* (2005).
- [6] RANIWALA, A., AND CKER CHIUH, T. Architecture and algorithms for an ieee 802.11-based multi-channel wireless mesh network. In *Proceedings of IEEE Infocom* (2005).
- [7] RAPPAPORT, T. *Wireless Communications: Principle and Practice*. Prentice Hall, 1996.
- [8] SO, J., AND VAIDYA, N. Routing and channel assignment in multi-channel multi-hop wireless networks with single network interface. *Technical Report, University of Illinois at Urbana Champaign* (2005).
- [9] STINE, J. A., DE VECIANA, G., GRACE, K. H., AND DURST, R. C. Orchestrating spaital reuse in wireless ad hoc networks using synchronous collision resolution. *World Scientific Journal of Interconnection Networks* (2003).
- [10] XU, K., GERLA, M., AND BAE, S. How effective is ieee 802.11 rts/cts handshake in ad hoc networks? In *Proceedings of IEEE GLOBECOM* (November 2002).