

ISTITUTO NAZIONALE DI FISICA NUCLEARE

IT8500230

Sezione di Bari

INFN/TC-83/11
16 Maggio 1983

M. De Palma, G. Macchia, G. Maggi, A. Ranieri, A. Sacchetti,
G. Selvaggi and P. Spinelli: A SCINTILLATOR HODOSCOPE
SYSTEM FOR A HIGH INTENSITY BEAM

Istituto Nazionale di Fisica Nucleare
Sezione di Bari

INFN/TC-83/11
16 Maggio 1983

A SCINTILLATOR HODOSCOPE SYSTEM FOR A HIGH INTENSITY BEAM

M. De Palma, G. Macchia, G. Maggi, A. Ranieri, A. Sacchetti, G. Selvaggi
and P. Spinelli
Dipartimento di Fisica dell'Università di Bari, and INFN - Sezione di Bari

ABSTRACT

In this paper we describe the construction and the operation of a scintillator hodoscope used in an intense beam. By using a fast scintillator (Pilot U), a XP1910 photomultiplier and an electronic chain, employing a fast Zero Crossing discriminator located close to the hodoscope and a differential discriminator as receiver in the counting room, a two pulse separation of 6 nsec per channel and a time resolution (σ) of 210 psec were obtained.

1. - INTRODUCTION

The investigation of rare processes in hadron interactions requires high beam intensities so as to achieve an adequate luminosity. For instance, the NA24 experiment, which studies large Pt direct photon production in hadronic interactions at 300 GeV/c incident momentum in the H2 beam line of the CERN North Area, requires a beam intensity typically of 2×10^7 charged particles per second (pps). Such particle flux could exceed the limit of a single element scintillation counter. Thus, a "multielement" counter is generally used⁽¹⁾.

We have built a scintillation counter hodoscope consisting of

- a) An X, Y hodoscope, each plane formed by 16 scintillator elements arranged in a single row covering the 99.5% of an area of $8 \times 8 \text{ cm}^2$;

- b) A 200 MHz service electronics consisting of fast zero-crossing discriminator with a built-in input stage amplifier, strobed coincidence and splitter modules, multiplicity logic units and a fast coincidence unit, located close to the hodoscope;
- c) A 200 MHz electronics consisting of differential discriminators acting as line receivers at the end of 90 m cables, followed by fast prescalers, located in the counting room;
- d) A LED system for set up purpose and test.

The purpose of this system was to provide measurements of the incident flux, a monitor of the beam profile, a fast signal detecting the presence of two or more beam particles very close in time (within a single RF bucket) and an accurate time reference.

2. - HODOSCOPE CONSTRUCTION

The system design was guided by:

- a) The need to limit the counting rate for each element to a level easily handled by a normal photomultiplier and a conventional base design;
- b) The need to minimize the dead time in order to obtain high efficiency at high rate;
- c) The need to achieve a good time resolution.

The hodoscope was located just after the last quadrupole of the H2 beam line, where the beam size is quite large ($7 \times 7 \text{ cm}^2$). In order to limit the counting rate on each scintillator element to a few 10^6 pps, its width transverse to the beam was set to 5 mm. A 6 mm thick scintillator (0.7% X_0) was used to get an adequate number of photons per beam particle and thus improve the time resolution. The scintillator element length was 120 mm. Pilot U scintillator was used because of its timing characteristics (1.26 nsec FWHM pulse width, 0.5 nsec rise time, 1.4 nsec decay time⁽²⁾) which are suitable for high rate applications.

The two hodoscope planes providing the first a horizontal (X) and the second vertical (Y) coordinate, are made of 16 adjacent scintillator elements held in position with an aluminium frame and which are optically insulated by a $25 \mu\text{m}$ aluminized mylar foil waved between them. The counter covers a total area of $8 \times 8 \text{ cm}^2$, of which only the 0.5% is inactive. In this geometry the gaps between the scintillator elements are determined by the thickness of the interspaced aluminized mylar. The solution with the scintillator elements displaced in two rows would have required a more complicated mechanical construction to avoid both gaps and overlaps. The overlaps, like the gaps, would have caused beam losses, since particles passing through

these regions would simulate two particles close in time, and thus be vetoed by the logic. Two more sheets of reflecting material are placed on the two faces of each hodoscope plane.

The scintillator elements are glued to the light guides made of UV transparent plexiglass rods (8 mm diameter) with "POWABAND"⁽³⁾. Some of the light guides are straight (130 mm long), while others have an "S" shape and a length of 150 mm as shown in Fig. 1. Adjacent elements have their light guides coming out from opposite end. Consequently, it was possible to mount the photomultipliers, and their basis, in three rows (4 cm apart), on each side of the scintillator elements. The light guides were left unwrapped and coupled to the photomultiplier with clear RTV. No systematic difference in the light transmission between the straight and "S" shaped light guides was found.

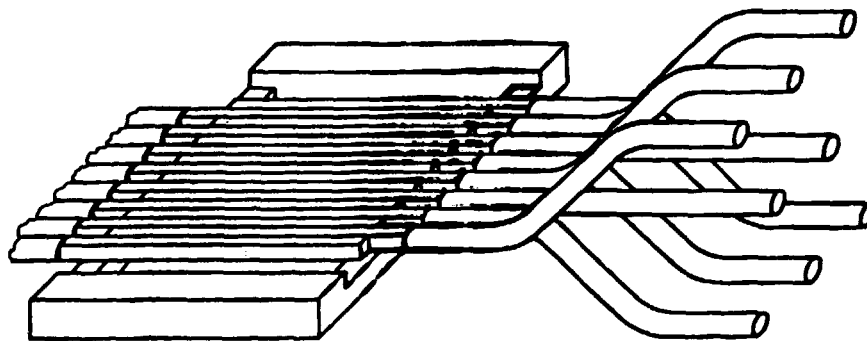

FIG. 1 - Hodoscope view.

A XP1910 photomultiplier (19 mm photocathode diameter, 10 stages) was used because of its rather fast rise time (2.5 nsec) and also for its relatively low cost. Only the central part of the photocathode was covered by the light guide. This reduces the jitter in the photoelectrons collection and improves the timing characteristics of the output pulse⁽⁴⁾. All photomultipliers were magnetically screened with two layers of 0.2 mm thick mu-metal. The voltage divider was obtained with a conventional 1 mA base with the last two stages Zener stabilized. The voltage between photocathode and the first dynode was also stabilized with a Zener diode and was maintained rather high (250 Volts). The anode output signal was differentiated for zero crossing discrimination with the standard clipping technique using a cable 35 cm long.

Scintillator elements, light guides and photomultipliers were placed in a light-tight aluminium box with paper windows in the beam region.

3. - ASSOCIATED ELECTRONICS

In order to determine the crossing of either a single or more than one particle in the hodoscope and provide a time reference, the hodoscope signals have to be handled by the service electronics. Moreover, the information has to reach the counting room, which is 60 m away. Both the service electronics and the connection system have to work with little dead time in order to handle high rates.

The service electronics has been located close to the hodoscope for the following reasons :

- a) To minimize the length of the cables connecting the photomultipliers output to the discriminators input, and, thus, to minimize the cable attenuation and distortion of the photomultiplier output signal;
- b) To form locally the signals needed in the trigger, thus reducing the number of signals to be sent to the counting room on fast cables;
- c) To send logical pulses to the counting room, hence reducing cable quality requirements and simplifying the receiver circuit.

A block diagram of the electronics located close to the hodoscope is shown in Fig. 2. A 200 MHz zero crossing (Z. C.) discriminator⁽⁵⁾ was used as input stage. It was based on the fast comparator AM685⁽⁶⁾ and the 100k Fairchild ECL family⁽⁷⁾. The input stage of the Z. C. discriminator was a x6 preamplifier based on BFR91 high fre

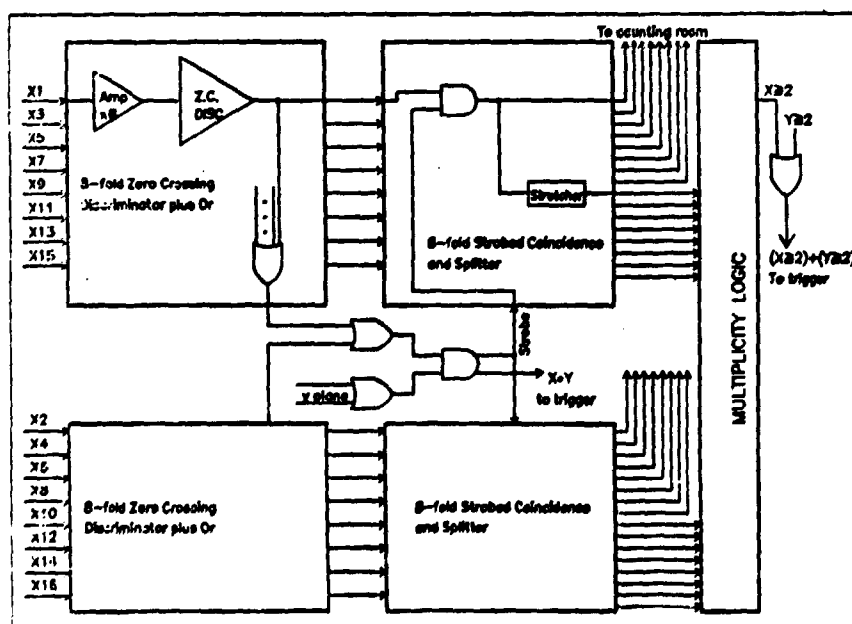

FIG. 2 - Block diagram of the close electronics.

quency transistors. The preamplifier allowed a minimum input threshold of 4 mV. Consequently the photomultiplier output signals could be kept low, and the average anodic current was well below its limit at the experimental beam rate.

The outputs of the Z. C. discriminators relative to a hodoscope plane were Ored together. The coincidence ($X \star Y$) of the two Or signals, one for each plane, defines a beam particle and provides the time reference.

The short individual outputs of the Z. C. discriminators (Fig. 3) were split by a "splitter" module. One of the "splitter" output signals was kept at 3 ns FWHM and sent to the counting room. The second one, widened to 6 ns FWHM, was used in the multiplicity logic unit. In order to eliminate photomultiplier noise, only the signals associated with an $X \star Y$ coincidence were allowed to pass through by means of a strobe signal. This module too was based on the 100k Fairchild ECL family and on BFR91 high frequency transistors.

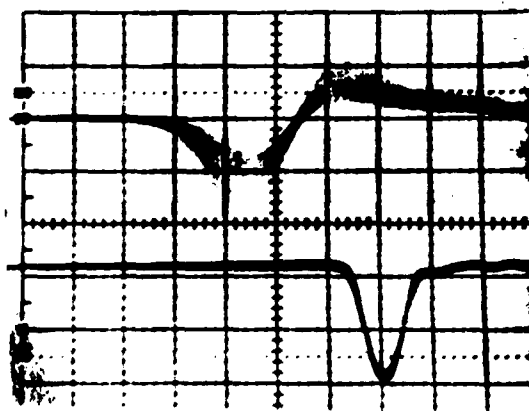

FIG. 3 - (top) Typical photomultiplier signals from a ^{90}Sr source (20mV/div, 2 ns/div); (bottom) Zero crossing discriminator output signals (500mV/div, 2 ns/div). The oscilloscope is triggered on the zero crossing output signal).

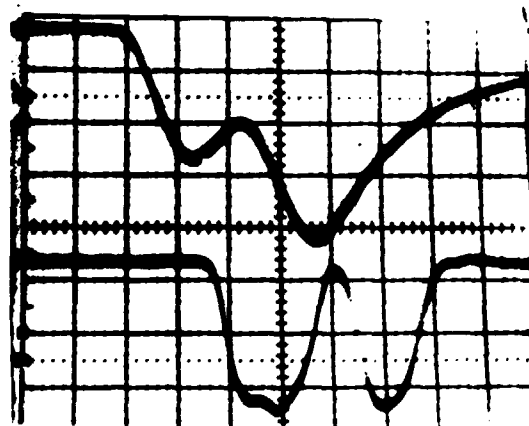

FIG. 4 - (top) Two "splitter" output signals separated by 5 ns after 90 m of RG58 cable (100 mV/div, 2 ns/div); (bottom) Trigger receivers output signals (500 mV/div, 2 ns/div).

The output $X \star Y$ of the coincidence unit and the Or ($X \star 2$) + ($Y \star 2$) of the two multiplicity units were sent through fast aircore cables to the counting room to be used in the trigger definition.

The signals relative to each channel reaching the counting room via RG58 cables 90 m long, are distorted by the long cables. Fig. 4 (top) shows two signals separated by 5 nsec at the end of a cable. The second pulse is on the tail of the first one. To get rid of the cable pile-up and keep a two pulse resolution of 5 ns, a differential discriminator⁽⁸⁾ was used as receiver. In this discriminator the input pulse is first sent directly

to the non-inverting input of the fast comparator AM685 and then, after a 2 ns delay, to the inverting input. Due to this the differential discriminator can detect fast transients, but not slow varying signal, moreover it is not sensitive to base line shifting, so it is ideal to eliminate cable pile-up. The output of the differential discriminator resulting from the input signal of Fig. 4 (top) is shown in Fig. 4 (bottom) where the two pulses are clearly resolved.

A fast prescaler based on a 11C90 followed by a MC10231 giving a total prescaler factor 40, was located in the same module. The prescaled signals can than safely counted by a common 100 or 50 MHz scaler.

4. - THE LED TEST SYSTEM

The hodoscope was equipped with a LED system both for testing and for setting up purposes. The LED and its driving circuit were chosen in order to get LED pulses of about the same shape (i. e. same rise time and length) as the ones resulting from beam particles. The LED used was a TII-262, a low power double LED, emitting in the red wavelength region (λ peak = 650 nm). The spectral sensitivity of the PM1910 in this region is adequate to give a LED induced pulse of the same amplitude as the one produced by a beam particle. The LED's were mounted on a printed board, together with the driving circuit shown in Fig. 5. They were positioned in front of the free-end of each scintillator element by mounting the printed board on the aluminum frame used to hold the hodoscope elements.

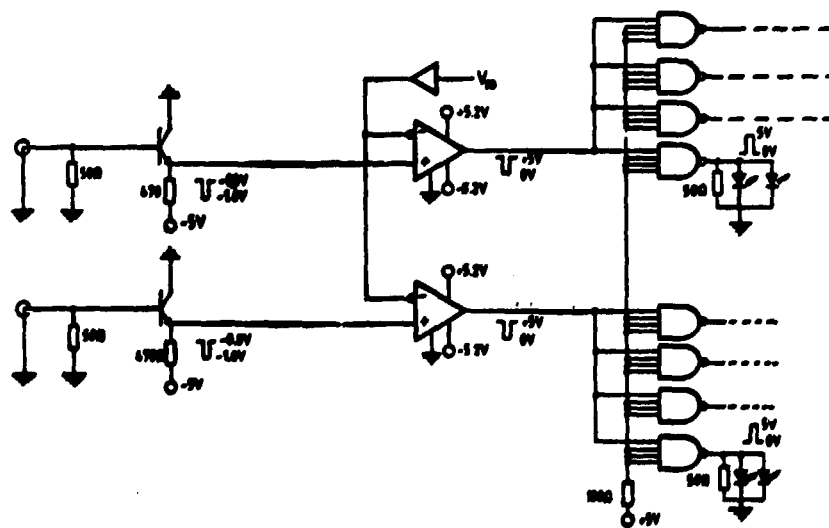

FIG. 5 - LED's driving circuit.

Hence, it was possible to check the status of the optical contacts. A typical LED pulse is shown in Fig. 6. The LED's pair per scintillation element allowed the study of the system double pulse resolution by varying the delay between the two LED driver pulses.

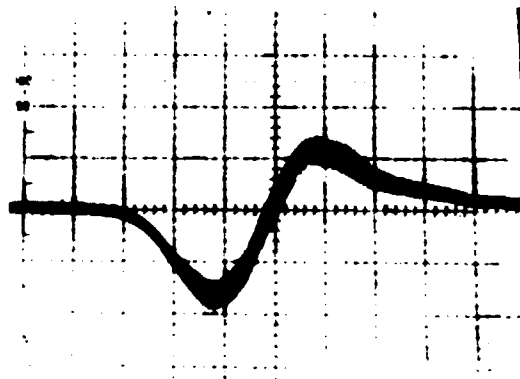
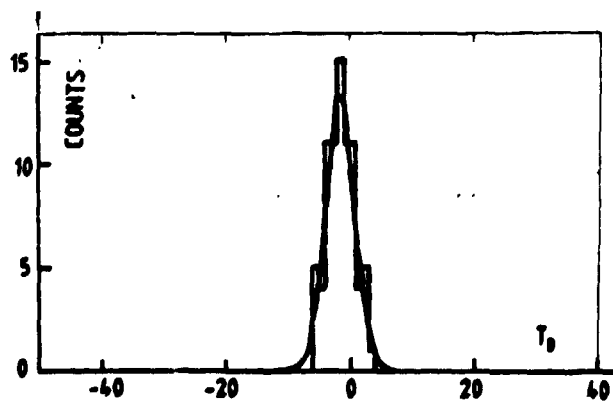

FIG. 6 - Typical photomultiplier output signal with LED pulse (20 mV/div, 2 ns/div).

5. - RESULTS

The hodoscope was installed in the H2 beam line of the North Area at CERN. The photomultipliers were operated at a typical voltage of 1350 Volts. This voltage was chosen in order to have an average output signal from beam particles of 40 mV (4 times the discriminator threshold). Typical output signal are shown in Fig. 3. In these conditions the rate limit per scintillator element was greater than 10^7 pps while the efficiency of the two planes coincidence $X \times Y$, measured with a particle flux of 2×10^5 pps per scintillator element, was 98.5%. By changing the average signal from 30 to 50 mV the efficiency did not vary appreciably. The amount of multiple hits (7%) in the hodoscope is consistent with the estimated rate of upstream interaction and δ ray production. This indicates that the cross-talk, if any, is negligible. The cross-talk was also checked by firing the LED's belonging to every other scintillator element on a plane and looking at the signals induced on the remaining ones. No appreciable signal was detected.

The system time resolution was measured considering the difference between the arrival times of the signals of two channels belonging to different planes. The result is the time difference distribution, shown in Fig. 7, with a σ of 300 ps. Assuming the



same time resolution for the two counters, a time resolution of 210 psec per counter is derived.

FIG. 7 - Distribution of the difference between the arrival time of the signals of two channel belonging to different planes (horizontal units: 100 ps).

The double pulse separation of the system was also checked by using the LED test system. The two LED's of one element were pulsed after a common trigger but with a variable delay between the two pulses. The ratio between the number of prescaler output pulses multiplied by 40, and the number of the triggers is shown in Fig. 8. It must be noted that the system can distinguish two pulses separated by 6 ns. This limit is set by the shape of the photomultiplier output pulse deriving from a LED (2.5 nsec rise time, 3 nsec FWHM (Fig. 6)). If simulated narrower pulses (1 nsec rise time, 2 nsec FWHM) are sent to the Zero Crossing discriminator, than a two pulse resolution better than 5 nsec is obtained as shown in Fig. 9. Since the photomultiplier signals deriving from particles are faster than those from LED, a single element two particle resolution better than 6 nsec is obtained.

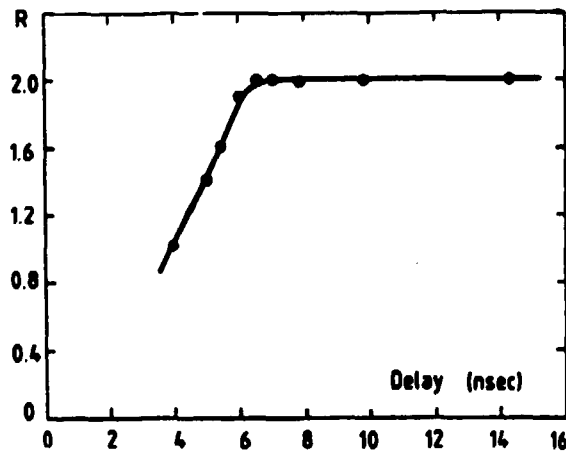

FIG. 8 - Double pulse resolution including the photomultiplier and the LED driving system.

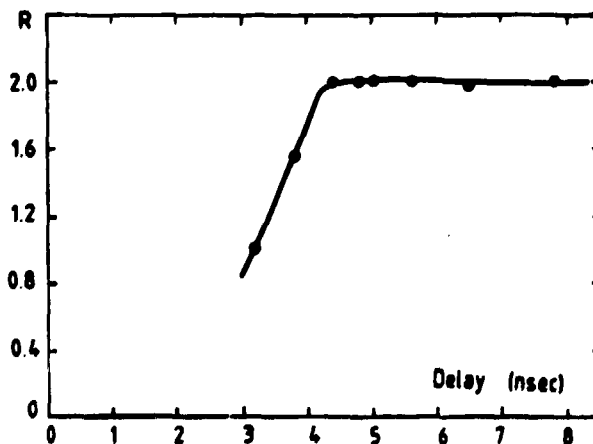

FIG. 9 - Double pulse resolution due to electronics only with a simulated input pulse.

ACKNOWLEDGEMENTS

We are grateful to Prof. C. De Marzo and Dr. K. Pretz] for their valuable suggestions. One of us (G.M.) is particularly indebted to Prof. B. D'Almagne, and to Dr. D. Brahy and Dr. E. Rossa for the very useful discussions on the electronics. We thank our technical staff in Bari for their skillful work in building the system. In particular we thank L. Dell'Oglio, R. Ferorelli and B. Facchini for the mechanical design and construction of the hodoscope, and E. Barbarito, T. Liuzzi, M. Perchiazzi and C. Pinto for the mounting and testing of the electronics. We thank Dr. B. Tarantino for revising the English text.

REFERENCES

- (1) - J. E. Elias et al., Nuclear Instr. and Meth. 141, 25 (1977); R. R. Crittenden et al., Nuclear Instr. and Meth. 186, 519 (1981); C. Bromberg et al., Nuclear Instr. and Meth. 200, 245 (1982).
- (2) - Nuclear Enterprises, Scintillators catalogue.
- (3) - Powaband, Double H International Marketing Ltd.
- (4) - Philips, Data Handbook of Phototubes and Photomultipliers.
- (5) - F. Couchot, These presentee a l'Université de Paris-Sud, Centre d'Orsay, pour le titre de Docteur 3eme Cycle, 1980 (unpublished).
- (6) - Advanced Microdevices, High Speed Comparator Databook.
- (7) - Fairchild, ECL Databook.
- (8) - D. Brahy and E. Rossa, Preprint CERN SPS/71-2 (EPB).



MICROCOPY RESOLUTION TEST CHART
NATIONAL BUREAU OF STANDARDS
STANDARD REFERENCE MATERIAL 1010a
(ANSI and ISO TEST CHART No. 2)