

LAMP/91/5

**INTERNATIONAL CENTRE FOR
THEORETICAL PHYSICS**

**LAMP
SERIES REPORT**

(Laser, Atomic and Molecular Physics)

INTRODUCTION TO OPTICAL FIBER SENSORS

Sh. Moukdad



**INTERNATIONAL
ATOMIC ENERGY
AGENCY**



**UNITED NATIONS
EDUCATIONAL,
SCIENTIFIC
AND CULTURAL
ORGANIZATION**

MIRAMARE-TRIESTE

Preface

The ICTP-LAMP reports consist of manuscripts relevant to seminars and discussions held at ICTP in the field of Laser, Atomic and Molecular Physics (LAMP).

These reports aim at informing LAMP researchers on the activity carried out at ICTP in their field of interest, with the specific purpose of stimulating scientific contacts and collaboration of physicists from Third World Countries.

If you are interested in receiving additional information on the Laser and Optical Fibre activities at ICTP, kindly contact Professor Gallieno Denardo, ICTP.

International Atomic Energy Agency
and
United Nations Educational Scientific and Cultural Organization
INTERNATIONAL CENTRE FOR THEORETICAL PHYSICS

LAMP SERIES REPORT

(Laser, Atomic and Molecular Physics)

INTRODUCTION TO OPTICAL FIBER SENSORS

Sh. Moukdad *

International Centre for Theoretical Physics, Trieste, Italy.

ABSTRACT

Optical fiber sensors have many advantages over other types of sensors, for example: low weight, immunity from EMI, electrical isolation, chemical passivity, and high sensitivity. In this seminar, a brief explanation of the optical fiber sensors, their use, and their advantages will be given. After, a description of the main optical fiber sensor components will be presented. Principles of some kinds of optical fiber sensors will be presented, and the principle of the fiber-optic rotation sensor and its realization will be discussed in some details, as well as its main applications.

MIRAMARE – TRIESTE

June 1991

* Permanent address: Scientific Studies and Research Center, P.O.B. 4470, Damascus, Syria.

I- Optical fiber sensors -what are they?

They are essentially a means whereby light guided within an optical fiber can be modified in response to an external physical, chemical, biological, biomedical or similar influence. Light from an optical source with constant relevant optical properties is launched into a fiber and guided to the point at which measurements are to take place. At this point either the light can be allowed to exit the fiber and be modulated in a separate zone before being relaunched into either the same or different fiber- these are called extrinsic sensors- or the light can continue within the fiber and be modulated in response to the measurand whilst still being guided- these are known as intrinsic sensors. Some sensors function by causing the light guided in the fiber to couple via the evanescent field- these are a halfway house, but are perhaps best classified with the extrinsic devices. Fig. (1) shows these basic concepts.

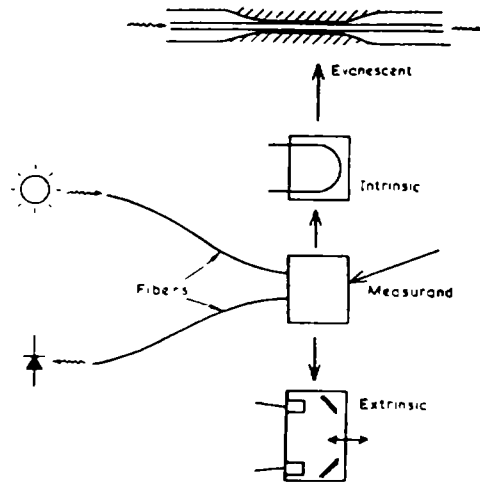

Fig. 1 Schematic diagram of intrinsic and extrinsic fiber optic sensors. The evanescent field device has features of both

II- Optical fiber sensors- why and where use them?

The most important advantages of optical fiber sensors (OFS) all stem from the fact that the modulated signal can be transmitted to and from the sensing region without recourse to electrical connection. This gives the following principal features:

- a- Immune to radio frequency interference (RFI) and electromagnetic interference (EMI).
- b- Electrical isolation removing problems with ground plane separation and electrical safety regulations.
- c- Explosion-proof.
- d- Small size and weight.
- e- Removable.
- f- Allow access into normally inaccessible areas.
- g- Potentially high sensitivity and the ability to interface with wide range of measurands.
- h- Secure data transmission.
- i- High accuracy and solid state reliability.
- j- Can be interfaced with data communication systems.
- k- Potentially resistant to ionizing radiation.

Furthermore, for intrinsic sensors, the fact that the fiber is sensitive to the measurand of interest can be used as to form distributed networks which are very difficult, if not impossible, to realize using alternative technologies.

As a conclusion, we notice that OFS present great capabilities which are, in many cases, inaccessible using alternative technologies.

Examples of these include the measurement of current and voltage in very high EMI environment, and measurement of chemical constituents in the blood of patients undergoing surgical treatment. The low weight properties of fiber interconnects are beginning to make their mark in aerospace applications where the next generations of aircraft are likely to be flown using optical fiber sensing. As an example, table 1. lists some typical applications and the associated sensors required. All of those listed can go fiber optically.

Table 1
Sensors for Various Applications

Applications	Sensor
Automated production lines (steel, paper, etc.)	Position, thickness, limit switch, break detection, velocity
Process control	Temperature, pressure, flow, chemical analysis
Automotive	Temperature, pressure, torque, gas detection, acceleration
Machine tool	Displacement, tool break detection
Avionic	Temperature, pressure, displacement, rotation, strain, liquid level
Heating, ventilation/air conditioning (HVAC)	Temperature, pressure, flow
Appliance	Temperature, pressure
Petrochemical	Flammable and toxic gases, leak detection, liquid level
Military	Sound, rotation, radiation, vibration, position, temperature, pressure, liquid level
Geophysical	Strain, magnetic field
Utility	Temperature, displacement, electric and magnetic field

III-Optical fiber sensor components:

In this section a brief description of the OFS elements will be given, in addition to the order of magnitude properties of the various available components.

1- Modulators:

Light can be modulated in response to the physical measurand by different means, we may divide them into analog and digital (or quasi-digital) techniques.

Main analog quantities include the following:

- Intensity:

All optical detectors respond to this parameter. Precise repeatable measurements of optical intensity over a wide dynamic range are quite difficult due to the problem of the basic shot noise, which degrades the S/N ratio. Even when the S/N ratio is achieved, the stability of long-term measurements of intensity is considerably worse than this value.*

- Optical phase:

This parameter can be detected interferometrically, and hence it is one of the most sensitive ways of measuring physical changes. Optical-fiber-based magnetometers are the most sensitive means known (except for superconducting quantum interference devices (SQUIDS)) for monitoring magnetic fields. The optical fiber rotation sensor is another extremely sensitive means of measuring rotation. Optical phase in fibers is affected by temperature ($100 \text{ rad/m}^\circ\text{C}$), pressure ($10 \text{ rad/m}^2/\text{bar}$), strain ($10 \text{ rad/m}/\text{microstrain}$) and rotation ($0.05 \text{ rad/m}^2/\text{sec}$), where the values in parenthesis are typical for wavelength in the region of one micron.

-Polarization:

Polarization modulation is, in practice, very similar to interferometry. Light is launched along the two principal axes of a delay medium, which may be a fiber or a crystal, with equal intensity in each axis, and is detected using a polarization analyzer which is usually located to receive equal intensities from each principal axis in the neutral state. In the case of all fiber devices where birefringent fiber may be used, the sensitivity to temperature or pressure, for example, is typically two orders of magnitude below that of a direct interferometer. When birerigent crystals are used as the sensing element, the response will depend upon the characteristics of the crystal. As example, very successful pressure transducers based upon the observation of birerigence in quartz have been produced, although these are only useful at very high input pressure.

Digital and quasi digital can be implemented using the following techniques:

* See appendix.

-Modulation frequency:

Modulation frequency on a returned signal can be changed by causing the input light to interact with a mechanical oscillator which modulates the output light. The frequency of modulation in the output light is a direct measure of the frequency of the mechanical oscillator which in turn is related to the environmental parameter of interest.

-Doppler shifts:

These are a means for the unambiguous determination of apparent speed as observed from the end of the fiber and sometimes, with more exotic processing, they can be used to determine particle velocities. Doppler shifts are typically of the order of $1 \text{ Hz}/\mu\text{m}/\text{sec}$. A number of commercial systems are available which either use modified laser Doppler velocimetry or, more simply, rely upon differential mixing between the end of a probe fiber and the light reflected from the sample volume. Such systems are typically used to measure flow.

2- The measurand interface:

The modulator and the interface with the measurand are intimately connected and totally interdependent. However, it is useful to categorize the types of measurands which can be interfaced with a fiber-optic sensor. Mechanical parameters, e.g. pressure, temperature, flow, displacement etc., can be made to interact directly with light in the fiber causing direct modulation of the optical properties of the fiber itself for intrinsic sensors. Chemical quantities are typically measured using various forms of optical spectroscopy. The light used to illuminate the sample can be caused to interact with the sample either in a cell (i.e. an extrinsic device) or by coupling to the evanescent field in a waveguide. In both cases the normal techniques apply and the system will monitor changes in absorption lines, Raman shifts or fluorescence. Chemical properties materials can sometimes be recognized via changes in refractive index, although these devices are usually sensitive to temperature because the refractive index of all materials is temperature dependent.

3-The optical fiber link:

Typically optical fibers are associated with long-haul telecommunication systems, and nowadays fibers are available at low cost with high quality. However, the range of fibers which can and indeed should be used in sensors is much wider. These include conventional silica-based single mode and multimode fibers and plastic fibers. Fibers can all be characterized by their loss as a function of wavelength (attenuation spectrum), their numerical aperture and the core diameter, their mechanical properties including the external diameter, the coatings and the manner in which the fiber is finally cabled. The environmental influence of the fiber on the performances of the link can be significant, and for that the mechanical properties of the fiber should be taken into account. There are a wide range of fibers with special optical properties which have been used with varying degrees of success in sensors, and perhaps the most important

of these is the birefringent fiber. Other fibers with special electro- or magneto-optic properties offer substantial promise for future systems.

4-Optical sources for sensors:

An optical source can be specified in terms of the following basic parameters: its central operating wavelength, the optical line width, the variation in optical power with wavelength, the variation in optical power with optical loading (reflection), the way in which these parameters vary with operating temperature, electrical bias conditions and time. Optical sources have also important geometrical characteristics including: a numerical aperture, the luminance expressed in ($\text{watt}/\text{m}^2/\text{sterad}$). Optical sources also require some form of modulation. Types of optical sources include surface- and edge-emitting light-emitting diodes, semiconductor lasers, gas lasers and solid state externally pumped lasers. All these have been used for sensor systems.

5-Optical signal detectors:

Most, if not all, optical fiber sensors used some form of quantum optical detector, i.e. individual photons are converted into electronic carriers (electron-hole pairs in semiconductors, or electrons in photo multipliers) which are detected as electric current.

6-Fiber optic components and other micro-optics:

A range of components is also necessary for use in sensors, both to interface the fiber with the sensor itself and to perform spatial and temporal modulation functions. Micro-optic devices are particularly useful for extrinsic sensors to form the means whereby the light in the fiber can be coupled to the modulating element, for example, the graded index (GRIN) lens to perform collimation or one-to-one imaging functions. Other fiber optic components are needed for obvious reasons for example, coupler, optical modulation devices, some integrated optics devices (splitters for ex.).

7-Signal processing:

The signal processing unit in the detection system is principally there to attempt to correct for any spurious element detracting the quantity to be measured, and to provide an interface to the remaining control electronics in the system which the sensor is monitoring. The signal processing system can also be used to enhance sensitivity and selectivity, and the most important technique is the lock-in amplifier.

IV-Examples of optical fiber sensors:

1-Temperature sensors:

Fiber optic temperature sensor is needed to operate in a strong electro- magnetic field. Sensors with metallic leads will experience eddy currents in such environments, which will create both noise and the potential for heating the sensor, which, in turn, causes inaccuracy in the temperature measurement. Several fiber sensing concepts have been applied to temperature measurement, reflective, microbending, intrinsic, as well as other unique intensity modulated approaches are described in the literature. Phase modulated concepts also have been applied to temperature sensing. Here, we present an intrinsic concept of fiber optic temperature sensor. An intrinsic sensor for temperature involves the phenomenon of absorption. It has been found that rare earth materials such as Nd and Eu, when added to conventional glass, result in an absorption spectra with temperature-sensitive properties. Two wavelength were found with unique temperature behavior for Nd-doped fibers. As shown in fig.(2) at 840 nm the absorption decreases with temperature, at 860 nm the reverse is true up to 500°C. The intensity at each of the two wavelengths is determined and the ratio provides a measure of temperature, as shown in fig. (3). The operation range of the sensor is about 0 to 800°C. A schematic of the sensor system is shown in the fig.(4).

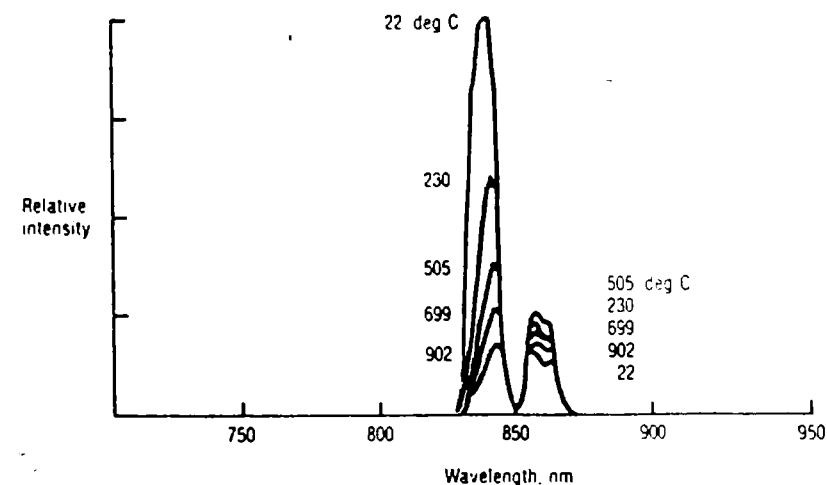

Figure 2
Temperature Sensitivity Absorption Spectra for a Neodymium Doped Glass Fiber

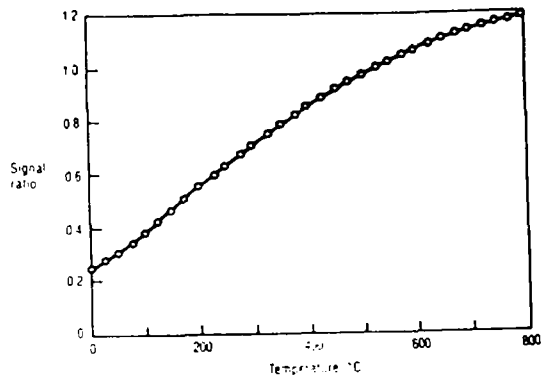

Figure 3
Temperature Response Curve for Neodymium-Doped Glass Fiber

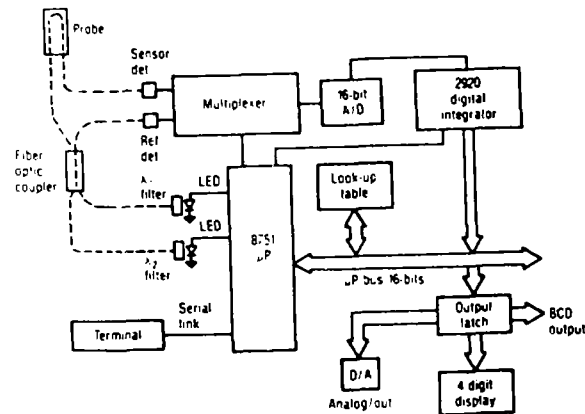

Figure 4
Sensor System Schematic

2-Pressure sensor:

Different concepts have been used in designing optical fiber pressure sensors. The driving force for the use of these sensors has been the small size, freedom from EMI and RFI, accuracy, and in the case of reflective displacement sensor, noncontact. The potential small size of a reflective diaphragm sensor has created considerable interest in medical application. Both intensity-modulated and phase-modulated fiber optic pressure sensors are being now designed for industrial use. Here we present an extrinsic fiber pressure sensor, using a transmissive concept. Fig.(5) shows this sensor, in which, a shutter interrupts the light path in a manner proportional to the pressure intensity. Using a reference and sensing channel provides ratiometric data with achievable full scale accuracies of 0.1%.

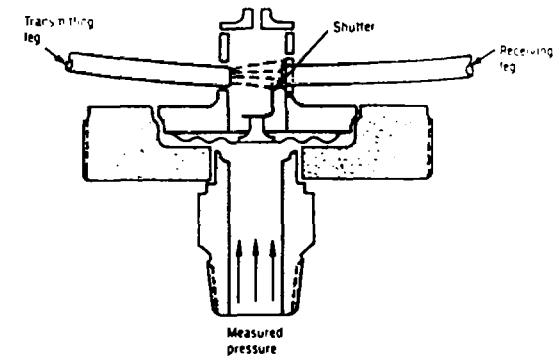

Figure 5
Transmissive Fiber Optic Pressure Sensor Using a Shutter to Modulate the Intensity

3-Fiber optic rotation sensor(gyroscope):

The fiber optic gyroscope (FOG) holds a very scientific position in the fiber optic sensor field, it is based on the Sagnac effect, which, according to relativistic theory, is essentially a problem of clock synchronisation, fundamentally independent of matter, whereas other optical sensors rely on various interactions between light and the

propagation medium. This kind of sensors is the only fiber sensor for which a 180 dB dynamic range is not only an ideal, but a reasonable engineering goal. The principle of an interferometric FOG depends on the Sagnac interferometer which is basically a ring interferometer where the input light wave is split and follows, in opposite directions, the same closed path defined by mirrors as shown in fig.(6) which represent the basic Sagnac interferometer. Fig.(7) shows the Sagnac interferometer made by optical fiber. Now if the system is at rest the clockwise wave (CWW) and the counterclockwise wave (CCWW) recombine without difference of optical path. If the system is rotated with an Ω angular velocity then the optical path will be different and phase shift between CWW and CCWW will be introduced.

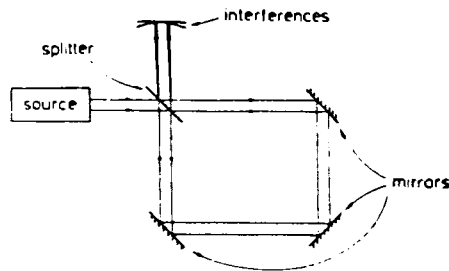

Fig.6 Original Sagnac interferometer with a closed path defined by mirrors

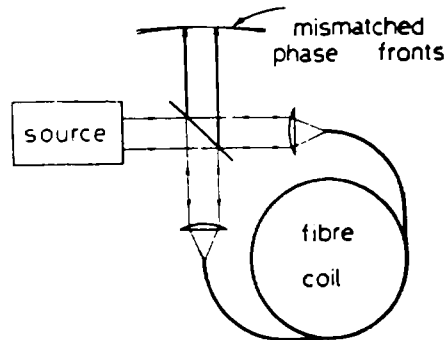

Fig. 7 Ring interferometer with a multiturn fiber coil.

Calculations give the following relation for this phase shift:

$$\Delta\Phi_s = \frac{2\pi L \cdot D}{\lambda \cdot c} \cdot \Omega_{||}$$

Where : λ - wavelength in the free space.

L - length of the fiber.

D - the diameter of the coil.

$\Omega_{||}$ - the rate component parallel to the coil axis.

Two significant examples can be given:

1. Medium sensitivity: $\lambda = 0.84\mu m, L = 200m, D = 30mm$, yielding π radian Sagnac phase shift for $\Omega_{||} = 1200^\circ/sec$.
2. High sensitivity: $\lambda = 0.84\mu m, L = 1km, D = 90mm$, yielding π radian Sagnac phase shift for $\Omega_{||} = 80^\circ/sec$.

Here are some problems which occur in FOG:

- Fundamental shot noise, the S/N ratio is proportional to the square root of the returning optical power.
- The alignment of the system is never perfect, that affects enormously the output phase fronts, and consequently produces a high parasitic drift.
- The residual birefringence of the fiber may affects severely the shift and contrast of the fringes also.

These problems could cause a severe limitation to high performance. All these problems can be solved very simply with a so-called reciprocal configuration. Fig.(8)** shows the so-called minimum FOG configuration in which reciprocity is achieved. Other problems concerning stable zero operation, high sensitivity operation, low drift and the multiple parasitic effects have been treated and overcome by using a proper biasing, proper modulation and demodulation schemes etc. . With the advent of the integrated optics, FOG's received a great push, and high performance with low cost seems reasonable goal. The applications of FOG's are presented in the table 2.*** In the market we can find FOG's of 40 dB dynamic range and $0.01^\circ/h$ as a drift.

** See appendix

*** See appendix

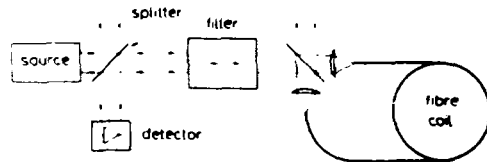
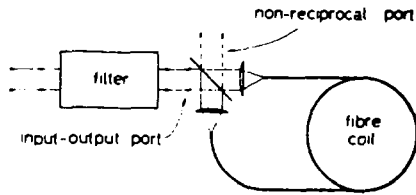
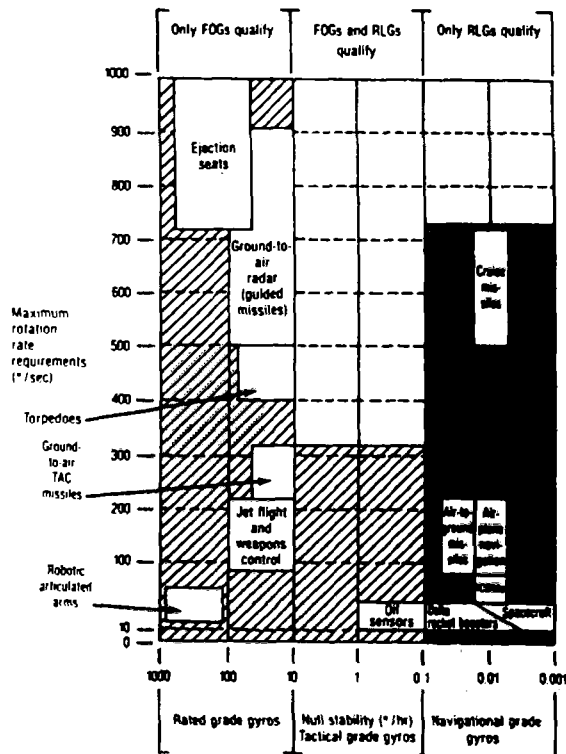

Fig. 8 Reciprocity in a fiber ring interferometer: (a)—Single-mode filtering in a fiber ring interferometer at the common input-output port; (b)—Reciprocal configuration of a fiber ring interferometer.

Table 2



Appendix

* From the "granular" nature of light and photon statistics one can prove that there exists an ultimate limit on the accuracy with which a light power level can be measured.

In the text we mean this limit and its value.

For more details see [4] page 36.

** It has been showed that a simple fiber ring interferometer (Fig. 7) is not intrinsically reciprocal. A small change in the alignments does not strongly modify the input power coupling, but has a big effect on the matching of both output phase fronts, which modifies the fringe pattern, and consequently produces a high parasitic drift.

The so-called "reciprocal" configuration (Fig. 8) solve this problem since in this configuration, the interfering waves follow the same path till the detector.

For more details see [5] page 386 .

*** Table 2 presnts applications of FOG's and RLG's according to two parameters: null stability requirments (X-axis) and maximum rotation rate requirments (Y-axis).

RLG = Ring Laser Gyroscope.

References

- [1] "Fiber Optic Sensors, Fundamentals and Applications", D.A.Krohn, Instrument Society of America, 1988.
- [2] "Handbook of Fiber Optics, Theory and Applications", Chai Yeh, Academic Press, Inc. 1990.
- [3] "Fiber Optic Communications", Joseph C. Palais Prentice-Hall International Editions, 1988.
- [4] "Optical Fiber Sensors: Systems and Applications", Edited by Brian Culshaw and John Dakin, volume 1, Artech House, 1988.
- [5] "Optical Fiber Sensors: Systems and Applications", Edited by Brian Culshaw and John Dakin, volume 2, Artech House, 1989.