

Induced Plant Mutations in the Genomics Era

Edited by Q. Y. Shu



Joint FAO/IAEA Programme
Nuclear Techniques in Food and Agriculture

Induced Plant Mutations in the Genomics Era

Edited by Q. Y. Shu

Plant Breeding Section,
Joint FAO/IAEA Division of Nuclear Techniques in Food and Agriculture,
International Atomic Energy Agency,
Vienna, Austria



Joint FAO/IAEA Programme
Nuclear Techniques in Food and Agriculture

Food and Agriculture Organization of the United Nations
Rome, 2009

The designations employed and the presentation of material in this information product do not imply the expression of any opinion whatsoever on the part of the Food and Agriculture Organization of the United Nations (FAO) or the International Atomic Energy Agency (IAEA) concerning the legal or development status of any country, territory, city or area or of its authorities, or concerning the delimitation of its frontiers or boundaries. The mention of specific companies or products of manufacturers, whether or not these have been patented, does not imply that these have been endorsed or recommended by FAO or IAEA in preference to others of a similar nature that are not mentioned.

The views expressed in this information product are those of the author(s) and do not necessarily reflect the views of FAO or IAEA.

ISBN 978-92-5-106324-8

All rights reserved. Reproduction and dissemination of material in this information product for educational or other non-commercial purposes are authorized without any prior written permission from the copyright holders provided the source is fully acknowledged. Reproduction of material in this information product for resale or other commercial purposes is prohibited without written permission of the copyright holders.

Applications for such permission should be addressed to:

Chief

Electronic Publishing Policy and Support Branch

Communication Division

FAO

Viale delle Terme di Caracalla, 00153 Rome, Italy

or by e-mail to:

copyright@fao.org

© FAO & IAEA 2009

Preface

The year 2008 marks the 80th anniversary of mutation induction in plants. The application of mutation techniques, i.e. Gamma-rays and other physical and chemical mutagens, has generated a vast amount of genetic variability and has played a significant role in plant breeding and genetic studies. The widespread use of induced mutants in plant breeding programmes throughout the world has led to the official release of more than 2,700 plant mutant varieties. A large number of these varieties (including cereals, pulses, oil, root and tuber crops, and ornamentals) have been released in developing countries, resulting in enormous positive economic impacts.

During the last decade, with the unfolding of new biological fields such as genomics and functional genomics, bioinformatics, and the development of new technologies based on these sciences, there has been an increased interest in induced mutations within the scientific community. Induced mutations are now widely used for developing improved crop varieties and for the discovery of genes, controlling important traits and understanding the functions and mechanisms of actions of these genes. Progress is also being made in deciphering the biological nature of DNA damage, repair and mutagenesis. To this end, the International Symposium on Induced Mutations in Plants was organized by the International Atomic Energy Agency (IAEA) and the Food and Agriculture Organization (FAO) of the United Nations through the Joint FAO/IAEA Division of Nuclear Techniques in Food and Agriculture.

The Symposium comprised an open session, two plenary sessions and ten concurrent sessions, covering topics from induced mutations in food and agriculture, plant mutagenesis, genetic diversity, biofortification, abiotic stress tolerance and adaptation to climate changes, crop quality and nutrition, seed and vegetatively propagated plants, gene discovery and functional genomics. A workshop on low phytate rice breeding was also organized. About 500 participants from 82 Member States of the IAEA and FAO, and nine international organizations/institutions attended the Symposium, with a good balance between the private and public sector, as well as developing and developed Member States. The Symposium received valuable assistance from the cooperating organizations and generous support from the private sector, for which the sponsoring organizations are most grateful.

This publication is a compilation of peer-reviewed full papers contributed by participants. They were either oral or poster presentations given in different sessions except Concurrent Session 3 (which will be compiled by the Human Health Division in a separate publication). These papers not only provide valuable information on the recent development in various fields related to induced mutations, but also on the social and economic impact of mutant varieties worldwide. Therefore, these Proceedings should be an excellent reference book for researchers, students and policy makers for understanding applications of induced mutations in crop improvement and biological research.

Qu Liang
Director
Joint FAO/IAEA Division of Nuclear Techniques in Food and Agriculture
IAEA

Table of Contents

Preface	1
Table of Contents	3
Opening Remarks by W. Burkart	7
Opening Remarks by S. Pandey	9
Summary of the FAO/IAEA International Symposium on Induced Mutations in Plants by T. Ishige	11
Closing Statement by A. M. Cetto	13
A Summary of the International Symposium on Induced Mutations in Plants	15
OPENING SESSION	
1. R. L. Phillips, <i>et al.</i> , <i>Expanding the Boundaries of Gene Variation for Crop Improvement</i>	21
2. P. J. L. Lagoda, <i>Networking and Fostering of Cooperation in Plant Mutation Genetics and Breeding: Role of the Joint FAO/IAEA Division</i>	27
PLENARY SESSION 1	
INDUCED MUTATIONS IN FOOD AND AGRICULTURE	
3. M. C. Kharkwal, <i>et al.</i> , <i>The Role of Induced Mutations in World Food Security</i>	33
4. U. Lundqvist, <i>Eighty Years of Scandinavian Barley Mutation Genetics and Breeding</i>	39
5. J. N. Rutger, <i>The Induced sd1 Mutant and Other Useful Mutant Genes in Modern Rice Varieties</i>	44
6. H. Nakagawa, <i>Induced Mutations in Plant Breeding and Biological Researches in Japan</i>	48
7. S. F. D'Souza, <i>et al.</i> , <i>Mutation Breeding in Oilseeds and Grain Legumes in India: Accomplishments and Socio-Economic Impact</i>	55
8. S. Srisombun, <i>et al.</i> , <i>Achievements of Grain Legume Variety Improvement Using Induced Mutation of the IAEA/RAS/5/040 Project in Thailand</i>	58
9. M. A. Haq, <i>Development of Mutant Varieties of Crop Plants at NIAB and the Impact on Agricultural Production in Pakistan</i>	61
10. K. T. Do, <i>Socio-Economic Impacts of Mutant Rice Varieties in Southern Vietnam</i>	65
CONCURRENT SESSION 1	
MUTATION ENHANCEMENT OF GENETIC DIVERSITY AND CROP DOMESTICATION	
11. T. Komatsuda, <i>et al.</i> , <i>Mutational Events in a Homeobox Gene Vrs1 that Created a Six-Rowed Spike in Barley Domestication</i>	71
12. P. D. Chen, <i>et al.</i> , <i>Irradiation-Induced Wheat-Alien Translocation Lines and their Application in Wheat Breeding</i>	74
13. P. Si, <i>et al.</i> , <i>Induced Mutation in Narrow-Leafed Lupin Improvement: An Example of Herbicide Tolerance</i>	77
14. L. A. Burdenyuk-Tarasevych, <i>Results of Utilization of Chernobyl Radio Mutant in Breeding Programmes of Triticum aestivum L.</i>	80
15. E. Nehnevajova, <i>et al.</i> , <i>Sunflower Mutants with Improved Growth and Metal Accumulation Traits Show a Potential for Soil Decontamination</i>	83
16. P. Manju, <i>et al.</i> , <i>Anjitha - A New Okra Variety through Induced Mutation in Interspecific Hybrids of Abelmoschus Spp.</i>	87
17. J. D. Barshile, <i>et al.</i> , <i>Genetic Improvement of Chickpea (Cicer arietinum L.) Using Induced Mutations</i>	91
18. A. B. Tambe, <i>et al.</i> , <i>Gamma-Ray Induced Mutations in Soybean [Glycine max (L.) Merrill] for Yield-Contributing Traits</i>	95
19. S. G. Auti, <i>et al.</i> , <i>Induced Mutagenesis in Mungbean (Vigna radiata (L.) Wilczek)</i>	97
20. A. Badigannavar, <i>et al.</i> , <i>Genetic Enhancement of Groundnut (Arachis hypogaea L.) for High Oil Content through Gamma-Ray Mutagenesis</i>	101
21. S. J. Jambhulkar, <i>et al.</i> , <i>Development and Utilization of Genetic Variability through Induced Mutagenesis in Sunflower (Helianthus annuus L.)</i>	104
22. J. G. Manjaya, <i>Genetic Improvement of Soybean Variety VLS-2 through Induced Mutations</i>	106
CONCURRENT SESSION 2	
DNA DAMAGE, REPAIR AND GENOME STABILITY	
23. N. D. Huefner, <i>et al.</i> , <i>Characterization of Two H2AX Homologues in Arabidopsis thaliana and their Response to Ionizing Radiation</i>	113
24. H. Puchta, <i>et al.</i> , <i>Role of Human Disease Genes for the Maintenance of Genome Stability in Plants</i>	118
25. V. Manova, <i>et al.</i> , <i>Genomic and Gene-Specific Induction and Repair of DNA Damage in Barley</i>	122
26. J. A. Da Costa-Nunes, <i>et al.</i> , <i>An Approach to Screen and Identify Novel Meiotic Mutants in an EMS Mutant Population</i>	126

CONCURRENT SESSION 4

INDUCED MUTATIONS FOR TRAITS THAT AFFECT ABIOTIC STRESS TOLERANCE AND ADAPTATION TO CLIMATE CHANGE

27. T. Kuromori, *et al.*, *Systematic Phenotype Analysis of Arabidopsis Ds-tagged Mutants to Unravel Gene Functions in Abiotic Stress Response as well as Growth and Development* 131
28. T. Gechev, *et al.*, *Mutational Analysis to Dissect Oxidative and Abiotic Stress in Arabidopsis thaliana* 134
29. M. C. González, *et al.*, *Development of Salinity-tolerant Rice Varieties Using Biotechnological and Nuclear Techniques* 138
30. J. A. de Ronde, *et al.*, *Evaluation and Characterization of Mutant Cowpea Plants for Enhanced Abiotic Stress Tolerance* 141
31. P. Suprasanna, *et al.*, *Radiation Induced In Vitro Mutagenesis, Selection for Salt Tolerance and Characterization in Sugarcane* 145
32. R. A. K. Moustafa, *Development of Salt-tolerant High-yielding Barley Lines via Crossing Between a Mutant Induced by EMS and a Local Cultivar* 148
33. J. P. Lal, *et al.*, *Genetic Enhancement of Lentil (Lens Culinaris Medikus) for Drought Tolerance through Induced Mutations* 151

CONCURRENT SESSION 5

INDUCED MUTATIONS FOR ENHANCING CROP QUALITY AND NUTRITION

34. V. Raboy, *Induced Mutation-facilitated Genetic Studies of Seed Phosphorus* 157
35. S. K. Rasmussen, *et al.*, *Biosynthesis and Deposition of Seed Phytate and its Impact on Mineral Bioavailability* 162
36. Y. Nakamura, *et al.*, *Revealing the Complex System of Starch Biosynthesis in Higher Plants Using Rice Mutants and Transformants* 165
37. D. von Wettstein, *Mutants Pave the Way to Wheat and Barley for Celiac Patients and Dietary Health* 168
38. Y. Xu, *et al.*, *Maize Mutant Opaque2 and the Improvement of Protein Quality Through Conventional and Molecular Approaches* 172
39. J. M. Fernández-Martínez, *et al.*, *Mutation Breeding for Oil Quality Improvement in Sunflower* 177
40. L. Munk, *et al.*, *The Multiple Uses of Barley Endosperm Mutants in Plant Breeding for Quality and for Revealing Functionality in Nutrition and Food Technology* 182
41. N. Tomlekova, *et al.*, *Creation and Evaluation of Induced Mutants and Valuable Tools for Pepper Breeding Programmes* 187
42. S. B. Kaveri, *et al.*, *Induced Mutagenesis for Oil Quality Enhancement in Peanut (Arachis hypogaea L.)* 191
43. C. Yathaputanon, *et al.*, *Protein Content in High-Protein Soybean Mutants in Thailand* 195
44. A. Patnaik, *et al.*, *Genetic Enhancement of Speciality Rice through Induced Mutation - Short-Grain Aromatic Rice* 197
45. A. Patil, *et al.*, *Development of a High Oleic Soybean Mutant and its Stability Across the Environments* 200
46. N. Tomlekova, *et al.*, *Study of Tomato Lines with High Nutritive Quality* 203

CONCURRENT SESSION 6

NEW TECHNIQUES AND SYSTEMS FOR MUTATION INDUCTION

47. L. Stoilov, *et al.*, *Restriction Endonucleases as a Tool for In Vivo Induction of Chromosomal and DNA Damage in Barley Genome* 209
48. L. X. Liu, *et al.*, *Achievements and Perspectives of Crop Space Breeding in China* 213
49. A. Tanaka, *Establishment of Ion Beam Technology for Breeding* 216
50. H. Feng, *et al.*, *Mutagenic Mechanisms of Ion Implantation in Plants* 220
51. C. Q. Cai, *et al.*, *Zinc Finger Nuclease-Mediated Gene Targeting in Plants* 223
52. A. R. Prina, *et al.*, *Genetically Unstable Mutants as Novel Sources of Genetic Variability: The Chloroplast Mutator Genotype in Barley as a Tool for Exploring the Plastid Genome* 227
53. H. Hussain, *Mutagenesis of Genes for Starch Debranching Enzyme Isoforms in Pea by Zinc-Finger Endonucleases* 229
54. H. Wang, *et al.*, *Generation of New Rice Cultivars from Mature Pollen Treated with Gamma-Radiation* 231

CONCURRENT SESSION 7

HIGH THROUGHPUT TECHNIQUES FOR MUTATION SCREENING

55. B. J. Till, *et al.*, *Global TILLING Projects* 237
56. V. Talamè, *TILLING with TILLmore* 240
57. L. S. Lee, *et al.*, *EMAIL - A Highly Sensitive Tool for Specific Mutation Detection in Plant Improvement Programmes* 243
58. K. Van, *et al.*, *DNA Sequence Analysis of Induced Mutants in Soybean* 245
59. T. L. Wang, *et al.*, *Driving Forward in Reverse* 247

CONCURRENT SESSION 8

MUTATION INDUCTION AND BREEDING OF ORNAMENTAL AND VEGETATIVELY PROPAGATED PLANTS

60. S. K. Datta, *A Report on 36 Years of Practical Work on Crop Improvement Through Induced Mutagenesis* 253
61. E. S. Louzada, *Citrus Improvement Using Mutation Techniques* 257
62. S. Nagatomi, *et al.*, *Mutation Breeding Of Chrysanthemum by Gamma Field Irradiation and In Vitro Culture* 258
63. C. Mba, *et al.*, *Enhancing Genetic Diversity Through Induced Mutagenesis in Vegetatively Propagated Plants* 262
64. T. Sanchez, *et al.*, *Induction and Identification of Useful Mutations for Root Quality Traits in Cassava* 266
65. K. E. Danso, *et al.*, *Application of Induced Mutation Techniques in Ghana: Impact, Challenges and the Future* 270

66.	A. S. Nair, <i>et al.</i> , <i>Molecular Characterization of Somatic Mutation in Musa acuminata 'Red'</i>	273
67.	R. Ibrahim, <i>et al.</i> , <i>Gamma Irradiation-Induced Mutation for the Improvement of Jospine Pineapple Against Bacterial Heart Rot Disease and Improved Fruit Quality</i>	276
68.	L. J. C. B. Carvalho, <i>et al.</i> , <i>Natural Genetic Variation in Cassava (Manihot esculenta Crantz) Landraces: A Tool for Gene Discovery</i>	279
69.	M. Abraham, <i>et al.</i> , <i>Induced Mutations in Coleus (Solenostemon rotundifolius) (Poir. J.K. Morton) – An Under-Utilized Medicinal Tuber</i>	283
70.	J. Belasque Júnior, <i>et al.</i> , <i>Resistance of Mutants of Sweet Orange Induced by Gamma-rays to Citrus Canker (Xanthomonas citri subsp. citri) Under Artificial Inoculation</i>	286
71.	P. Huzar Futty Beejan, <i>et al.</i> , <i>Use of Irradiation for the Induction of Mutations in Oyster Mushrooms for Improvement of Strains</i>	289
72.	X. Hou, <i>et al.</i> , <i>The Breeding of Arthrospira platensis Mutants with Good Quality and High Yield Induced by Space Flight</i>	293
73.	S. Seetohul, <i>et al.</i> , <i>Improvement of Taro (Colocasia esculenta var esculenta) Through In Vitro Mutagenesis</i>	296
74.	S. K. Datta, <i>Role of Classical Mutagenesis for Development of New Ornamental Varieties</i>	300
75.	S. K. Datta, <i>et al.</i> , <i>Management of Chimera and In Vitro Mutagenesis for Development of New Flower Color/Shape and Chlorophyll Variegated Mutants in Chrysanthemum</i>	303
76.	I. Sutarto, <i>et al.</i> , <i>Development of Promising Seedless Citrus Mutants Through Gamma Irradiation</i>	306
77.	E. C. Nwachukwu, <i>et al.</i> , <i>The Development of New Genotypes of the White Yam by Mutation Induction Using Yam Mini-tubers</i>	309

CONCURRENT SESSION 9

INDUCED MUTATIONS IN SEED CROP BREEDING (1)

78.	S. Tan, <i>et al.</i> , <i>Developing Herbicide-Tolerant Crops From Mutations</i>	315
79.	D. Landau-Ellis, <i>et al.</i> , <i>Marker-assisted Backcrossing to Incorporate Two Low Phytate Alleles Into the Tennessee Soybean Cultivar 5601T</i>	316
80.	Z. Sağel, <i>et al.</i> , <i>The Improvement of TAEK-Sağel Chickpea (Cicer arietinum L.) Mutant Variety in Turkey</i>	319
81.	S. P. Landge, <i>et al.</i> , <i>Development of B. Napus Canola Quality Varieties Suitable for Indian Agro-climatic Conditions by Induced Mutations</i>	322

CONCURRENT SESSION 10

INDUCED MUTATIONS IN SEED CROP BREEDING (2)

82.	H.-J. Koh, <i>et al.</i> , <i>A UGPase1-blocked Male Sterility Mutant and Its Possible Use in Hybrid Seed Production of Rice</i>	327
83.	L. Gómez-Pando, <i>et al.</i> , <i>Barley (Hordeum vulgare) and Kiwicha (Amaranthus caudatus) Improvement by Mutation Induction in Peru</i>	330
84.	Y. Jia, <i>Understanding the Molecular Mechanisms of Disease Resistance Using Rice Mutants</i>	333
85.	S. T. Kajjidoni, <i>et al.</i> , <i>An Innovative Way of Developing an Improved Variety Utilizing Both Gamma-ray-induced and Recombinational Variability in Blackgram (Vigna mungo L. (Hepper))</i>	336
86.	P. J. White, <i>et al.</i> , <i>Induced Mutations Affecting Root Architecture and Mineral Acquisition in Barley</i>	338
87.	M. Q. Vinh, <i>et al.</i> , <i>Current Status and Research Directions of Induced Mutation Application to Seed Crops Improvement in Vietnam</i>	341
88.	H. L. Nadaf, <i>et al.</i> , <i>Induced Genetic Variability for Yield and Yield Components in Peanut (Arachis hypogaea L.)</i>	346
89.	V. Phadvibulya, <i>et al.</i> , <i>Selection for Resistance to Yellow Vein Mosaic Virus Disease of Okra by Induced Mutation</i>	349
90.	K. Boonsirichai, <i>et al.</i> , <i>Genetics of the Radiation-induced Yellow Vein Mosaic Disease Resistance Mutation in Okra</i>	352
91.	S. Ngampongsai, <i>et al.</i> , <i>Current Status of Mungbean and the Use of Mutation Breeding in Thailand</i>	355
92.	S. Gvozdenovic, <i>et al.</i> , <i>Intervarietal Differences in Response of Sunflower (Helianthus annuus L.) to Different Mutagenic Treatments</i>	358
93.	K. S. Reddy, <i>A New Mutant for Yellow Mosaic Virus Resistance in Mungbean (Vigna radiata (L.) Wilczek) Variety SML-668 by Recurrent Gamma-ray Irradiation</i>	361
94.	B. K. Das, <i>et al.</i> , <i>Isolation of Early Flowering Mutant in Cultivar C-306 Known for its Good Chapati-making Quality</i>	363
95.	J. Zhang, <i>et al.</i> , <i>A Bentazon and Sulfonyleurea-sensitive Mutant in Rice and its Application in Hybrid Rice</i>	366
96.	L. Yang, <i>et al.</i> , <i>Dwarf Male-Sterile Wheat: A New Revolutionary Breeding Approach to Wheat</i>	370
97.	Y. Y. Barve, <i>et al.</i> , <i>Induced Mutations for Development of B. Juncea Canola Quality Varieties Suitable for Indian Agro-climatic Conditions</i>	373
98.	A. S. Syed, <i>et al.</i> , <i>Development of Improved Varieties of Rapeseed and Mustard Through In Vivo Mutagenesis and Hybridization in Pakistan</i>	376
99.	R. Peiris, <i>et al.</i> , <i>M 127 - A Promising Tomato Variety Developed Through Induced Mutation Technique</i>	379
100.	N. Benslimani, <i>et al.</i> , <i>Induction of Dormancy in Spanish Groundnut Seeds (Arachis hypogaea L.) Using Cobalt-60 Gamma Irradiation</i>	381
101.	A. Luzi-Kihupi, <i>et al.</i> , <i>Mutation Breeding for Rice Improvement in Tanzania</i>	385
102.	R. Pathirana, <i>et al.</i> , <i>Use of Induced Mutations to Adopt Aromatic Rice to Low Country Conditions of Sri Lanka</i>	388
103.	V. Kumar, <i>et al.</i> , <i>Characterization of Pre-breeding Genetic Stocks of Urdbean (Vigna mungo L. Hepper) Induced Through Mutagenesis</i>	391
104.	M. O. Balogun, <i>et al.</i> , <i>Development of High Yielding, Late Maturing Kenaf (Hibiscus cannabinus) Using Gamma Irradiation</i>	395

PLENARY SESSION 2

INDUCED MUTATIONS IN THE GENOMICS ERA: NEW OPPORTUNITIES AND CHALLENGES

105.	P. M. Gresshoff, <i>et al.</i> , <i>Functional Genomic Analysis of Systemic Cell Division Regulation in Legumes</i>	399
106.	T. Frank, <i>et al.</i> , <i>Metabolite Profiling of Induced Mutants of Rice and Soybean</i>	403

107. G. Rios, <i>et al.</i> , <i>Genomics Meets Induced Mutations in Citrus: Identification of Deleted Genes Through Comparative Genomic Hybridization</i>	407
108. I. Desgagne-Penix, <i>et al.</i> , <i>Mutagenesis as a Functional Genomics Platform for Pharmaceutical Alkaloid Biosynthetic Gene Discovery in Opium Poppy</i>	411
109. L. Munck, <i>et al.</i> , <i>From Discovery of High Lysine Barley Endosperm Mutants in the 1960-70s to New Holistic Spectral Models of The Phenome and of Pleiotropy in 2008</i>	419
110. G. G. Rowland, <i>The Effect of Plants With Novel Traits (PNT) Regulation on Mutation Breeding in Canada</i>	423
111. Q. Y. Shu, <i>Turning Plant Mutation Breeding Into a New Era: Molecular Mutation Breeding</i>	425
112. S. Sud, <i>et al.</i> , <i>Molecular Genotyping Of GA3 Insensitive Reduced Height Mutant of Emmer Wheat (Triticum dicoccum)</i>	428
113. H. Wang, <i>et al.</i> , <i>Genetic Analysis and Gene Mapping of Dwarf Mutant Rice CHA-1</i>	431
114. Z. Chen, <i>et al.</i> , <i>Genetic Analysis and Mapping of Mutant Dwarf Gene iga-1 in Rice</i>	434
115. M. J. Zamani, <i>et al.</i> , <i>Selection of Wheat Mutant Genotypes Carrying HMW Glutenin Alleles Related to Baking Quality by Using PCR (STS Method)</i>	436
116. S. Nielen, <i>et al.</i> , <i>Isolation and Characterization Of Retrotransposons in Wild and Cultivated Peanut Species</i>	439
117. F. L. Emediato, <i>et al.</i> , <i>Characterization of Resistance Gene Analogs in Musa acuminata Cultivars Contrasting in Resistance to Biotic Stresses</i>	443
118. K. Masmoudi, <i>et al.</i> , <i>Enhancing Drought and Salinity Tolerance in Wheat Crop Grown in the Mediterranean Region</i>	446
119. S. K. Datta, <i>et al.</i> , <i>Cyto-palynological, Biochemical and Molecular Characterization of Original and Induced Mutants of Garden Chrysanthemum</i>	450
120. K. Van, <i>et al.</i> , <i>Analysis of EMS Mutagenized Soybean by Combination of DOP-PCR and GS-FLX</i>	453
121. B. Naserian Khiabani, <i>et al.</i> , <i>Improvement of Mutant Wheat for Baking Quality Using Marker-assisted Selection</i>	455

Opening Remarks by W Burkart

Deputy Director General of the IAEA
Department of Nuclear Sciences and Applications

Dear colleagues, ladies and gentlemen,

It is a pleasure to welcome you to the Vienna International Centre for the International Symposium on Induced Mutations in Plants.

This international Symposium, promoted by the Joint FAO/IAEA Division, is the eighth of its kind – the first was held in 1969 - dedicated to harnessing and disseminating information on current trends in induced mutagenesis in plants. These symposia have dealt with themes relating to the development of efficient protocols for induced mutagenesis and their role in the enhancement of quality traits, as well as resistance to biotic and abiotic stresses in crops and the integration of *in vitro* and molecular genetic techniques in mutation induction.

The Joint FAO/IAEA Division has been promoting the efficient use of mutation techniques since the late 1960's, in line with the Agency's "atoms for peace" agenda, very much related to agricultural policy and practices of some of our main donor nations. In 1960, for example, in the United States, disease heavily damaged the bean crop in Michigan – except for a promising new variety that had been made by radiation breeding, which quickly replaced the old bean.

The Manual on Mutation Breeding, edited by the Agency and first published in 1970, updated in 1979 and reprinted several times afterwards, was the first book of its kind in the world. It has been widely used both as textbook in universities (translated into a couple of local languages) and reference book for breeders in their profession. Together with the training provided to scientists in developing countries and the support and coordination of research activities in this area, this manual has greatly promoted the correct and efficient use of mutation techniques in crop improvement.

At a time when the world is facing a food and energy crisis of unprecedented proportions, plant mutation breeding can be a catalyst in developing improved, higher-yield, saline-resistant sturdier crop varieties. More and more, the interest of the scientific community in this discipline has focused on the discovery of genes that control important traits, and on understanding the functions and mechanisms of actions of these genes.

The year 2008 will mark the 80th anniversary of mutation induction in crop plants. The widespread use of induced mutants in plant breeding programmes throughout the world has led to date to the official release of close to 3,000 mutant varieties from more than 170 different plant species. Many of these varieties (including cereals, pulses, oil, root and tuber crops, and ornamentals) have been released in developing countries, resulting in considerable positive economic impacts, which are measured in billions of US dollars and tens of millions of hectares of cropping area.

In effect, the application of mutation techniques, i.e. Gamma rays and other physical and chemical mutagens has generated a vast amount of genetic variability and plays a significant role in plant breeding and genetics and advanced genomics studies. There will be many recent mutation induction success stories presented here, in a wide range of disciplines. Please allow me to just cite two in the field of plant breed-

ing and genetics, fostered by the Agency through the Joint FAO/IAEA Division in collaboration with the Technical Cooperation Department:

The first example is:

(i) Mutant barley varieties that thrive in an up to 5,000 meter altitude in the inclement highlands of Peru. The adoption and cultivation of these mutant varieties account for over 52% yield increase between 1978 and 2002 translating to significant increases in income generation for the Indian farmers. For the socio-economic impact of improved barley mutant varieties, the Peruvian government has awarded the 2006 Prize of "Good Governmental Practices" to the principal counterpart.

The second example relates to:

(ii) Mutant rice varieties that thrive in the high salinity region of the Mekong Delta in Vietnam. The breeder of one of these varieties, with export quality that made it up amongst the five top export rice varieties, got the 2005 National Science and Technology Prize of Vietnam for this variety because of socio-economic impact.

These are just two examples of many that showcase the ability of mutation induction to produce hardier crops adapted to harsh environments.

Ladies and gentlemen, this year, 2008, will be remembered as the year in which the global conscience understood the realities of climate change, the food crisis and the energy debate and its link to hunger. These big issues are intimately interlinked, and translate in the agronomy field into a competition between food, feed and fuel for soil, water, human and financial resources.

Mutation induction has proven flexible, workable, and ready to use on any crop. In addition, it is a non-hazardous and low-cost technology that has the ability to address current challenges in agriculture. The breeding of new mutant varieties - with a higher yield potential, more productive biomass for energy use, better nutrient composition for human health, better adaptation to climate change and variability, or a heightened potential to sequester carbon - will be the driving force to meet the challenges of the 21st century.

Combined technology packages based on mutation induction, the most advanced genomic screening techniques and nuclear techniques applied to good agricultural practices will foster powerful new tools to improve plant breeding. In this respect, this Symposium brings together key players in basic research, as well as in the development and application of technologies relating to the efficient use of induced mutations for crop improvement and empirical genetic studies.

Ladies and gentlemen, dear colleagues, before you begin your deliberations, I would like to remind you that this Symposium is representative of one of the best collaborations in the United Nations system – the Joint FAO/IAEA Division - two sister agencies working for the welfare of humanity- a partnership that is already 44 years old.

I wish you fruitful discussions and a successful participation at the Symposium.

Opening Remarks by S Pandey

Representative of the FAO
Director of Plant Production and Protection
Agriculture and Consumer Protection Department

Mr. Chairman, distinguished guests, ladies and gentlemen,

On behalf of the Director General of the Food and Agriculture Organization in Rome, I bring you greetings and welcome you to the Joint FAO/IAEA International Symposium on Induced Mutations in Plants.

It has been 12 years since the last Symposium and I take this opportunity to congratulate Mr. Liang and his staff for organizing this Symposium at this time.

Crop plants form the major components of human diets, providing the required calories and nutrients to sustain life. With recent soaring of food prices, which is one of the immediate causes of the current food security crisis, the need to efficiently increase food availability through the production of high yielding crop varieties under the contrary effect of climate change and variability, plays a key role in ensuring food security.

As such, holding this Symposium at this moment in time is a significant and blissful coincidence.

An essential aspect of crop improvement is the utilization of the available genetic variation to produce new crop varieties. Induced mutations are a proven tool in creating a wealth of desirable genetic variability in plants, and its success in crop improvement abound.

Currently the Joint Division's mutant varieties database registers over 2,700 mutant and mutant-derived varieties. Furthermore, some of these mutant varieties have contributed significantly to the livelihoods of farmers and their respective country's economy. For instance:

- *Diamant* and *Golden Promise* being the progenitors of most of the cultivated barley varieties used in brewery industry in Scotland and most of Europe, contributing over 20 million US dollars per annum in additional income to farmers annually;
- *Durum* wheat varieties used in the pasta industry in Italy arising from mutants account for tens of millions of US dollars in additional income to farmers per annum;
- Grapefruit in the US with *Rio Star* mutant accounting for 75% of the US grapefruit industry;
- The mutant pear variety *Gold Nijesseiki* in Japan contributes 30 million US dollars in additional income to farmers annually;
- The rice mutant variety *Zhefu 802* yield 10.6 million ha in China, giving a yield increase of 10.5% between 1980 and 1995. This translates into providing food to an extra two million people per year; and
- In Vietnam, where rice export is one of the main national revenue sources, eight high-yielding mutant rice varieties with other socio-economic value traits including high quality, tolerance to salinity and short duration allowing up to three harvests per year have been developed and adopted by farmers, providing them an extra income of 300 million US dollars this year.

These successes and many more were achieved by including induced mutations in the plant breeding scheme.

The efficiency of mutation induction is directly related to producing, handling and assaying the required large numbers of mutant stocks and could be expensive, laborious, time-consuming and often dependent upon the growing season of the crop. However, recent advances in genomics, especially the quantum leap in the volume of publicly available genomics resources, imply that a high throughput platform such as Targeted Induced Local Lesions in Genomes (TILLING) which utilize induced mutations, will make the rapid evaluation of mutant stocks for specific genomic sequence alteration more practicable.

The history of the Joint FAO/IAEA Division dates back to 1964, and since then its activities have been aimed at promoting the use of nuclear technologies in crop breeding and genetics in our Member States.

Let me express my deep satisfaction with the efficient synergistic link the Joint FAO/IAEA Division provides between FAO and IAEA. Indeed, their input to FAO's programmes in agriculture is highly valued by the sister divisions in FAO, and I congratulate the Joint FAO/IAEA Division for 44 years of flawless service to the Member States of both organizations. In return, FAO is pleased to note the added value it could offer in return to the IAEA programming.

More of the successful results of our continued support to Member States, I believe, will be detailed to you during the presentations over the next three days.

Still there are challenges ahead. The looming adverse effects of climate change and variability affecting crop productivity requires intervention to produce new varieties which can perform more efficiently under severe water and climatic conditions, and also ensure a continued maintenance of the existing biodiversity.

Malnutrition, with respect to micronutrients like vitamin A, iron and zinc, affects more than 40% of the world's population. While various interventions such as supplementation and fortification have been proposed, providing major staple crop varieties that accumulate greater concentrations of vitamins and minerals in their edible tissues, will be a sustainable intervention particularly for low-income populations.

The demands for bioenergy crops and/or efficient use of existing crops to provide both food and fuel without threatening the current food supplies, pose yet another challenge for our crop improvement programmes.

I encourage you to consider these challenges in your deliberations and the potential of induced mutations by addressing these efficiently.

Ladies and gentlemen, again I welcome you to this Symposium.

Summary of the FAO/IAEA International Symposium on Induced Mutations in Plants by T Ishige

President

National Institute of Agrobiological Sciences, Japan

Thank you Mr. Chairman.

Ladies and gentlemen and distinguished guests,

On behalf of the Steering Committee, I would like to express my sincere appreciation to all the speakers and participants for their informative presentations and discussions during the Symposium. I would like to acknowledge and thank the members of this meeting for supporting this conference here in Vienna.

In the flyer, it is written that 2008 is the 80th anniversary of induced mutation breeding. The commercial utilization of approximately 3,000 mutant-induced and mutant-derived varieties strongly shows that mutation breeding is a useful tool for generating new germplasm for crop improvement.

Mutation induction by radiation is the method of choice in China, India and Japan. In plant genetic and breeding research, induced mutations have contributed to the discovery and identification of gene functions following the completion of genome sequencing projects in *Arabidopsis* and rice.

In this Symposium, a wide range of topics related to mutation breeding was discussed. In the keynote presentation, Dr. Ron Phillips showed the importance of expanding gene variation for crop improvement. He presented modern mutation technologies which are useful for practical plant improvement and plant science. Dr. Lagoda showed the importance of international cooperation in plant mutation genetics and breeding. He introduced the role of the joint FAO/IAEA Programme.

In Plenary Session 1, history and topics of mutation breeding of rice, barley, legumes and other crops in the world were presented.

In Concurrent Session 1, "Mutational Enhancement of Genetic Diversity and Crop Domestication" was discussed. The key genes responsible for domestication in barley, such as the 6-rowed spike, were identified by the use of natural variation and mutants. Unique agronomically useful characteristics were isolated in wheat, sunflower, soybean, and lupine.

In Concurrent Session 2, the topic "Plant Mutagenesis - DNA Damage, Repair and Genome" was discussed. Following the completion of the genome sequencing in *Arabidopsis* and rice, we can identify a particular mutation, such as deletion size and the point of mutation at the molecular level. Furthermore, the mechanism of gene function and gene repair can be identified.

In Concurrent Session 3, "Biofortification of Staple Food Crops for Improved Micronutrient Status" was discussed. One of the most important activities of the IAEA that of human nutrition, was presented. DNA changes that provide variations useful for human nutrition are seen to become increasingly important, including the transgenic approach (for example, golden rice). Many of these variations useful in human nutrition will be introduced together with new traits desired by growers (for example, submergence tolerant rice). Complex interaction such as the role of phytic acid in micronutrient availability was discussed.

In Concurrent Session 4, "Induced Mutations for Traits That Affect Abiotic Stress Tolerance and Adaptation to Climate Change" was dis-

cussed. Various approaches to develop crops with tolerance to abiotic stresses, including drought, salinity, and tolerant root systems were presented.

In Concurrent Session 5, "Induced Mutations for Enhancing Crop Quality and Nutrition" was discussed. Mutation research for seed phosphorus and useful starch mutants were presented. We also learned how a mutant trait can be modified by marker-assisted selection as in the example of Quality Protein Maize (QPM).

In Concurrent Session 6, "New Techniques and Systems for Mutation Induction" were discussed. New mutation technologies, such as transposon Tos17, restriction endonuclease, space irradiation, and ion beams, were presented.

In Concurrent Session 7, "High Throughput Techniques for Mutation Screening" was discussed. Screening for mutants is an important step in mutation breeding, as well as mutation induction. Recently, very useful molecular screening tools, such as TILLING, using the genome sequences of agronomically useful traits in some crops, have become available.

In Concurrent Session 8, "Mutation Induction and Breeding of Ornamental and Vegetatively Propagated Plants" was discussed. Mutation breeding is very useful for improvement in asexual crop species, where hybridization is not possible. Typically, in this area, breeding objectives are focused primarily on flower colour and shape, which can be easily screened by observation.

In Concurrent Sessions 9 and 10, "Induced Mutations in Seed Crop Breeding" was discussed. There are many useful traits induced by mutations, such as semi-dwarfness, resistance to diseases, and quality components of grains and beans.

In Plenary Session 2, "Induced Mutations in the Genomics Era: New Opportunities and Challenges" was discussed. Genomic analysis and metabolite profiling of induced mutants has become an excellent approach for the analysis of gene function.

In this Symposium, we discussed practical mutation breeding and the analysis of gene function originating from many mutants. As you know, now, genome science and molecular biology are very powerful tools to analyse gene function. Genome sequencing of rice was completed in 2005 by the International Rice Genome Sequence Project (IRGSP), with NIAS (National Institute of Agrobiological Sciences), in Japan playing the central role. This effort has resulted in dramatic changes in the mutation breeding of rice, as well as other monocot crops which show similar genomic synteny with rice. Molecular genetics and information technology based on genome sequencing will be presumably powerful tools for the selection of mutants exhibiting specific characteristics. NIAS is now extensively applying genome science to organisms such as rice, wheat, barley, soybean, silkworm and pig. The Radiation Breeding Institute of NIAS, directed by Dr. Nakagawa, is studying practical radiation breeding and creating of new genetic resources by mutation.

Furthermore, mutation technologies can provide many new genetic resources induced by radiation, chemicals, and several kinds of genetic engineering. Those new genetic resources are very useful not only for

practical breeding, but also for plant science. We can utilize and combine the multitude of useful genetic resources and modern molecular technologies.

Finally, I would like to draw some conclusions from this wonderful conference.

(1) Direct mutation in specific genes for specific traits

Scientists have utilized natural variation from spontaneous mutations, as well as induced mutations for many years. But now there are new technologies to direct mutation in specific genes for specific traits. With more and more genome and gene sequence information and more knowledge about gene regulation and gene networks, we will see the development of more “direct mutation” techniques. I predict that the next IAEA conference will feature direct mutagenesis methods as a major topic.

(2) Variation inherent in various species

We will probably also see more powerful methods for recognizing and utilizing the variation inherent in various species.

(3) Advancement of many new alleles at loci of interest.

Another advancement that became clear at this conference is our ability to recognize many new alleles at loci of interest.

(4) Base change by various mutagens

The new technologies presented here demonstrate the ability to produce many base changes by various mutagens.

(5) We also saw how even base changes not leading to a mutant phenotype are useful, for purposes such as tracing variation and farm products.

I believe this Symposium and the proceedings of the presentation, which will be published following this Symposium, will help establish the valuable role that mutation breeding has played in the disciplines of plant science and world agriculture. I hope that we will meet again in the near future and discuss the progress of the mutation research after this meeting.

Finally, we applaud the IAEA and FAO for organizing this excellent conference – as well as all their other activities of coordinating research, conducting research, development of database, and so forth.

Thank you so much.

Closing Statement by A M Cetto

Deputy Director General of the IAEA
Department of Technical Cooperation

Distinguished delegates, ladies and gentlemen

I am very pleased to speak to you today, as the International Symposium on Induced Mutations in Plants draws to a close.

This Symposium was the eighth in the Joint FAO/IAEA Programme's Symposium series, dedicated to harnessing and disseminating information on current trends in induced mutagenesis in plants. The first meeting was held in 1969, and the most recent in 1995. Thirteen years on, in a climate of increasing food shortages, it was high time that this Symposium was held. Although mutation breeding is 80 years old, as we just heard, new applications continue to be found and will continue to be developed. The application of mutation techniques, such as Gamma-rays and other physical and chemical mutagens, has generated a vast amount of genetic variability and has played a significant role in plant breeding and genetic studies in countries throughout the world. The importance of these techniques is reflected in the large number of participants gathered here: a total of 500 delegates from 81 countries that are IAEA and FAO Member States and nine organizations. I believe that the extensive scientific programme, which included 126 oral and 252 poster presentations, is an indicator of the range, depth and relevance of the topic.

Being aware of the scientific nature of this Symposium, let me however, say a few words on behalf of the IAEA's TC Programme. The programme provided financial support to several participants to attend this Symposium, but more importantly, many of the participants have been trained through the Technical Cooperation Programme, supported by the FAO/IAEA Joint Division. Technical training of this sort is a core component in the implementation of the IAEA mandate "Atoms for Peace, Health and Prosperity."

Over the past five years, food and agriculture has accounted for one of the largest areas of the IAEA Technical Cooperation Programme around the world, and projects in this area are on the increase in the 2009–2011 programme cycle. The Agency's combination of technical and managerial expertise offers Member States significant benefits in the formulation and development of projects, transfer of technology, infrastructure development and capacity building. Support is delivered through training courses, fellowships, expert and scientific visits, and through setting up of laboratories.

Ladies and gentlemen, Pandit Jawarlal Nehru, the great former prime minister of India, remarked once that "Everything else can wait but not agriculture," and this remark remains relevant today. There is no short-term magic formula to solve the world's food problems. We must take advantage of all possible modes of intervention and action. Nuclear technology will continue to play an essential role in strengthening conventional breeding through induced mutations and efficiency-enhancing biomolecular technologies. As we have just heard, there is now a trend towards directed mutagenesis. I am sure that our technical colleagues have taken note of the suggestion to dedicate the next Symposium to this topic. These will hopefully continue to represent safe techniques, respectful of nature and the environment, supporting and speeding

up natural processes to develop food and agricultural products with improved characteristics and increased value.

I sincerely hope that you have enjoyed your stay in Vienna, and that the Symposium has stimulated you to find innovative ways to face the challenges that face us all. Your work is key to ensuring the sustainability of agriculture and to meeting the ever-growing global demand for food resources.

I wish you all the best in your continuing endeavours and a safe journey back to your home countries.

Thank you.

A Summary of the International Symposium on Induced Mutations in Plants

Q Y Shu

1. Organization of the Symposium

The International Symposium on Induced Mutations in Plants was held from 12-15 August, 2008 at the Vienna International Centre. Almost 500 participants, more than half of them from developing countries, attended the Symposium. Nine international organizations and 82 member countries, among these 60 developing countries, were represented at the Symposium.

The Symposium was opened by IAEA's Dr. W. Burkart, Deputy Director General, Department of Nuclear Sciences and Applications. Dr. S. Pandey, Director, delivered opening remarks on behalf of the Food and Agriculture Organization of the United Nations. Also in the opening session, Professor R. Phillips (USA), Vice President of the International Crop Science Society, delivered a keynote address on "Expanding the Boundaries of Gene Variation for Crop Improvement," and Dr. P.J.L. Lagoda, Head of the Plant Breeding and Genetics Section in the IAEA, introduced the role of the Joint FAO/IAEA Programme on Nuclear Techniques in Food and Agriculture in networking and fostering of cooperation in plant mutation genetics and breeding. Dr. T. Ishige, President of the Japanese National Institute of Agrobiological Sciences summarized the opportunities and the way forward for plant mutagenesis in the genomics era, and Dr. A.M. Cetto, Deputy Director General of the Department of Technical Cooperation in the IAEA, officially closed the Symposium after highlighting the role of technical cooperation in promoting the use of mutation techniques in Member States.

Apart from opening and closing session, the Symposium was organized into two Plenary Sessions, 10 Concurrent Sessions, and one Workshop. Four hundred twenty-four abstracts were submitted for the Symposium - out of these, 129 papers were selected for oral presentation (including invited talks) and 184 for poster presentation.

The Symposium was organized by the International Atomic Energy Agency (IAEA) and the Food and Agriculture Organization (FAO) of the United Nations through the Joint FAO/IAEA Division of Nuclear Techniques in Food and Agriculture. The great cooperation and support of the following organizations contributed to the success of the Symposium and is highly commended: Bhabha Atomic Research Centre (BARC, India); Chinese Society of Agricultural Biotechnology, European Association for Research and Plant Breeding, Indian Society of Genetics and Plant Breeding, and National Institute of Agrobiological Sciences (Japan).

2. Overview of topics of the Symposium

The year 2008 marked the 80th anniversary of mutation induction in crop plants. Although induction of mutations had often been considered as accidental for a long time since it was discovered, it has been globally explored and has significantly contributed to increased agricultural production over the past half century. During the past 10 years, more and more molecular biological studies have proven that mutations are

not mere "accidents," but that they could be deliberately induced, using various methods. Meanwhile, induced mutations have become more and more useful and important in modern genetic studies, such as gene discovery and function elucidation. By integrating molecular techniques, such as high throughput mutation screening techniques, induced mutations are now widely expected to play an even greater role in plant improvement than ever before. Progress in all those fields was repeatedly reported by various groups at the Symposium, which not only demonstrated the recent renaissance of mutation techniques but also outlined a bright future for these classic techniques.

2.1 Induced mutations for world food security

The widespread use of induced mutants in plant breeding programmes throughout the world has led to the official release of more than 2,700 mutant plant varieties. A dozen presentations convincingly documented the contribution of induced mutations to the increase of agricultural production that is valued in the billions of US dollars and millions of hectares of cultivated area. It is noteworthy that a large number of mutant varieties had been developed and widely cultivated in developing countries, hence greatly improving food security in those countries.

With population growth, the demand for food and feed is growing as well, while natural resources are limited. Erratic rain falls, sudden and severe drought conditions, excessive floods, etc., often related to climate change, even deteriorate crop production conditions. The yield potential of crop plants has to be significantly increased to combat the worsening food security situation. Traditionally, induced mutants with favourable traits have been directly or indirectly used in breeding new varieties. During the last decade, induced mutations have also been gaining increasing importance in plant molecular biology as a tool to identify and isolate genes and to study their structure and function. Knowledge of genes controlling important agronomic and quality traits are critical for plant breeders to develop proper strategies and efficiently implement breeding programmes. Therefore, induced mutations can contribute further to increasing global food production both directly and indirectly by increasing yield potential and stability.

2.2 Genetic diversity, crop domestication and improvement

Genetic variability is a very basic asset for crop domestication and improvement, as well as genetic research. While some plant species of cultivated crops have rich genetic diversity, others have very limited genetic variation. In Concurrent Session 1 alone, mutational enhancement of genetic diversity was reported in 17 plant species; those mutated populations will become important genetic resources for breeding, gene discovery, and functional analysis of various genes.

The work on lupine provided an excellent example of how spontaneous and induced mutations were utilized in the domestication and

improvement of a modern crop. The introduction of the narrow leaf mutation resulted in the domestication of lupine as a dominant legume crop in Australia. The herbicide tolerance mutation showed the potential to double the yield by growing lupine under irrigation when herbicide is used for weed control.

Radiation was also proven to be effective for the production of wheat-alien translocation lines, which thus sets up a unique method for tapping genetic variability of wild species into cultivated crop plants. A research group in China established a sophisticated protocol and has used the introduced genetic variation for the development of several elite wheat varieties.

The potential of induced mutations for soil decontamination was demonstrated in sunflower. During the past two decades, the use of plants has been proposed as an alternative technique to remove toxic metals from contaminated soils. The efficiency of this technique largely depends on the biomass production and toxic metal uptake of plants grown in contaminated soils. In this direction, sunflower mutants generated through chemical mutagenesis were reported to have the capacity for the extraction of cadmium, zinc, and lead, three to five times higher than their wild type parent.

2.3 Induced mutations for quality and nutrition improvement

Induced mutation has long been used for the enhancement of crop quality and nutrition - two sessions (Concurrent 3 and 5) and one workshop were devoted to discourse on these topics. Many attributes of these two characteristics were covered. The research covered the enhancing of mineral elements (biofortification) and amino acids essential for humans and animals, alteration of protein and fatty acid profiles for nutritional and health purposes, as well as change of physicochemical properties of starches for different end-uses, to the enhancement of phytonutrients in fruits and reduction of anti-nutrients in staple foods. Several mutant genes have been successfully introduced into commercial crop varieties and significantly enhance the nutritional value of those crops. A few examples are given below:

1. **Quality Protein Maize (QPM).** Maize endosperm protein is deficient in two essential amino acids, lysine and tryptophan. The *opaque 2* mutant gene, together with endosperm and amino acid modifier genes, was used for the development of QPM varieties. QPM has almost twice as much lysine and tryptophan, and 30% less leucine, as normal maize, and has shown to have dramatic effects on human and animal nutrition, growth and performance. QPM varieties are now grown on hundreds of thousands of hectares.
2. **Low phytic acid (LPA) crops.** Much of the phosphorus is deposited as phytic acid and its salt form (phytate) in seeds. Since phosphorus and mineral elements such as iron and zinc in the form of phytate cannot be digested by humans and monogastric animals, reduction of phytic acid would increase the bioavailability of phosphorus and micronutrient mineral elements. Reports at the meeting showed a number of LPA mutations have been induced in barley, rice, wheat, and soybean, and new LPA barley varieties were released for commercial use. It is anticipated that LPA varieties will be eventually developed in various crops, which might ultimately reduce both phosphorus-pollution and increase bioavailability of phosphorus and micronutrient minerals in cereal grains and legume seeds.
3. **Oilseeds with optimised fatty acid compositions.** The optimal composition of plant oils depends on their end uses, for example, unsaturated fatty acids (oleic, linolenic) are desirable for salad and cooking oils, but increased concentration of saturated fatty acids

(stearic, palmitic) is preferred for oils used in the food industry, since high temperature processes (frying) require oils resistant to thermo-oxidation. A number of papers described the alteration of fatty acids composition by mutation induction in soybean, sunflower, and other oil crops. By using the mutated genes, new varieties have been developed for numerous purposes.

2.4 New techniques for mutation induction, screening and utilization

In the past decade, there have been substantial technological developments in the induction, screening, and utilization of mutated genes. Traditionally, plant materials are treated with physical or chemical mutagens, such as Gamma-rays, ethyl methane sulphonate (EMS), and mutants are screened from the progenies in the field for morphological traits, or in the laboratory for chemical components. Due to the usually low mutation frequency, large populations need to be screened, which makes it rather expensive and sometimes impossible to identify a target mutation. The new developments reported at the Symposium include the use of space flight, ion irradiation, and transposable elements for mutation induction, the use of restriction endonuclease for site-directed, homologous recombination; DNA markers linked to mutated genes for marker-assisted selection and tracing of the gene, and target-induced local lesions in genomes (TILLING), as well as different variant versions for high throughput screening of mutated alleles.

New techniques for mutation induction. In China, spacecraft, recoverable satellites, and high altitude balloons have been used to bring seeds into space for mutation induction. During the past 10 years, more than 60 new mutant varieties were developed through this special programme. Ion beam irradiation has also been explored for plant mutation induction, mostly in China and Japan. Low energy ion beams are commonly used in China (mostly for agriculturally important crops), while high-energy ion beams are adopted in Japan (mostly for ornamental plants of high market value). The reports raised much interest among the participants. The transcriptional activation of transposable elements and their incorporation into various regions of the genome was reported in rice and maize. Since the position of transposable elements could be identified using PCR techniques, the mutation caused by transposition could be precisely positioned, and mutated genes could be easily identified. Another development of mutation induction is the use of restriction endonucleases (REs) for inducing double-strand breaks in plant genomes and consequently resulting mutations. This technology has been further integrated with zinc finger DNA binding proteins -zinc finger nucleases, and is now used for site-specific mutagenesis.

High throughput techniques for mutation discovery. One concurrent session was devoted specifically to presentations on this fast developing topic. Reports demonstrated that the TILLING technology is high throughput, cost-effective, and applicable to most organisms, hence its application is rapidly expanding. While TILLING was originally designed for screening mutations in mutant populations generated with chemical mutagens, such as EMS, it was also shown that it could be adopted to use mutant populations developed through physical mutagenesis, such as gamma and fast neutron irradiation. For example, the De-TILLING technique could be effectively used to detect a specific mutant in a pool of 6,000 plants. The other trend of mutation discovery technique is the use of high-throughput DNA sequencing techniques; several next-generation sequencing instruments are already available and it is foreseen that the mutation discovery will become more and more efficient and cost-effective.

A number of papers presented results on identification of DNA markers linked to mutated traits. These findings will be useful for marker-

assisted selection and eventually for the cloning of mutant genes. This type of work has become an integrated part of mutation programmes in developed countries, and more recently in developing countries as well.

2.5 Integration of induced mutations with new “omics” techniques

While many papers across the different sessions discussed the use of molecular techniques or investigation at molecular level, the second plenary session highlighted the new trend of the integration of induced mutations with newly emerged “omics” techniques. These include genomics and functional genomics, microarray technology and transcriptomics, metabolite profiling, and spectral models of phenomes.

Induced mutants are investigated in a systematic way by the use of “omics” techniques, which coincides with the newly emerged subject “systems biology.” Since the genetic background of mutants and their parent varieties only slightly differs, genes and pathways of mutated traits could be identified through comparative studies using various “omics” techniques. For example, results of metabolite profiling of low phytic acid mutants and their parents were indicative of the genes mutated in rice and soybean, and the deleted genes were identified through comparative genomics analysis in Citrus. These reports should be read not only for their importance of the particular subject, but also for the new direction and for the possible fields in which induced mutation can play a role in plant science.

2.6 Understanding the molecular basis of plant mutagenesis

Understanding the genetic control of plant mutagenesis is vital for the proper application and manipulation of mutation induction for enhancing genetic variation and plant mutation breeding. A session was assigned for some deliberations of progress in this field. Presentations covered topics such as recombination and extrachromosomal DNA on genome stability and evolution, and the role of human disease gene homologues for the maintenance of plant genomes, DNA repair mechanisms in the extremely radio resistant bacterium, the influences of environmental stresses (radiation, toxic metals, etc.) on plant genome stability, and DNA damage caused by various mutagenic agents. While most studies are not directly related to experimental mutagenesis, particularly for mutation induction, they could nevertheless provide useful information for studies on the molecular mechanisms of induced mutagenesis in plants.

3. The role of the Joint FAO/IAEA Programme on the Nuclear Techniques in Food and Agriculture

For more than 40 years, the Joint FAO/IAEA Programme has been promoting the research, development, and application of nuclear techniques in food and agriculture in the Member States. The use of nuclear techniques for plant genetics and breeding is a major field. The great achievements of the Joint Programme and the vital assistance given to Member States were widely and gratefully acknowledged by the participants during and after the Symposium.

3.1 Symposia on plant mutation breeding and genetics

With the successful completion of the International Symposium on Induced Mutations in Plants, the Joint FAO/IAEA Programme has already organized nine international symposia and numerous meetings in the field of Plant Breeding and Genetics. These events are the major international scientific forums for researchers working in this field. New

ideas are sparked at the meetings and research topics conceptualized through discussion have become a source of force driving the progress of this scientific discipline. More than 80 letters of appraisal from participants demonstrate the high relevance and quality of the recent Symposium.

3.2 IAEA Technical Cooperation projects

The IAEA Technical Cooperation projects (TC projects), technically backstopped by the Joint FAO/IAEA Programme, play a great role in capacity building and efficient use of nuclear techniques for plant breeding in the Member States. Many of the success stories presented at the Symposium are from project counterparts, such as barley mutants in Peru, legume variants in India and Pakistan, as well as mutant rice in China, Tanzania, and Vietnam.

3.3 IAEA coordinated research projects

The IAEA's coordinated research projects (CRPs) are playing a unique role in promoting research and networking among scientists of both developing and developed countries. Three research coordination meetings of ongoing CRPs were organized in conjunction with the Symposium, and 17 CRP participants made oral presentations at the Symposium.

3.4 Future directions

As reflected by the presentations at the Symposium, induced mutations are playing an important role in modern plant improvement; their efficiency and application as a technology for crop improvement and plant research is foreseen to grow in the years to come. Mutation breeding is approaching a molecular era, which requires the extensive use of molecular techniques in mutation induction, screening, and utilization. Therefore, Member States will need to substantially improve their capacities to make full use of the opportunities of scientific advance. In this regard, the Joint Programme should continue to assist Member States through CRPs, TC projects and other efficient instruments.

The Symposium also highlighted some fields that the Joint Programme should pay special attention to. For example, the understanding of genetic control of the process of DNA damage, repair, and mutagenesis has been limited. This is vital for the proper application and manipulation of mutation induction for enhancing genetic variation and plant mutation breeding. High throughput techniques, such as TILLING, provide great promise, but their applicability and effectiveness in practical crop improvement programmes, particularly in developing nations, needs to be critically evaluated.

Opening Session

Expanding the Boundaries of Gene Variation for Crop Improvement

R L Phillips^{1,*} & H W Rines²

Abstract

Directed and undirected mutagenesis continues to offer unique opportunities for crop improvement. Mutations also occur naturally and different forms are present in each strain of plants within and among species. Modifying genes affect the expression of all mutants and examples exist where the deleterious features of a mutant can be significantly changed by selection. New technologies, including those associated with genomics such as re-sequencing, TILLING, and RNA interference, allow the detection of gene variation at an unprecedented frequency. Knowledge of genes that affect recombination among homoeologous chromosomes may lead to inducible methods regulating the exchange among chromosomes in a polyploid species. Forward and reverse genetic methods are readily available in many species, including model plant species. There are an estimated one million sites in the japonica rice genome tagged via Tos17, Ac/Ds, T-DNA, and other insertion elements. Site-specific mutagenesis and gene replacement methods may replace the need for transgenic technology in some cases. Transcriptome modification occurs via mutagen treatment, aneuploidy, and uniparental chromosome loss, and sometimes results in a mutant phenotype. The boundaries of gene variation appear to be more expansive as plant genetics knowledge and technologies increase.

Introduction

Mutations reflect alternatives (exceptions) to the normal state of a gene or chromosome structure. William Bateson[1] said: “Treasure your exceptions”. Indeed, these exceptions provide the variation for selection of new and useful types of plants as well as the basis for evolution. Mutations are as natural as nature itself and have led to many positive outcomes (see Plant Mutation Reports and Plant Breeding & Genetics Newsletters; www.naweb.iaea.org/nafa/index.html, and www.fao.org/waicent/VAOINFO/Agricult?Default.htm).

Eighty years ago, L.J. Stadler [2, 3] demonstrated the induction of mutations in barley and maize by using x-rays and radium. In 1937, A.H. Sturtevant[4] said “Mutations are accidents, and accidents happen.” These comments reflect the period of biology when we could only draw on naturally-occurring mutations or technology that led to “undirected mutagenesis.” But now, “directed mutagenesis” methods are increasingly common where mutations can be planned. Genome sequence information is often required for the new directed mutagenesis applications. Fortunately, for today’s plant scientists, at least 23 plant species’ genomes either have been, or are currently being sequenced [5, 6]. The use of model species, such as *Arabidopsis* [7], is also leading to the more rapid development of new mutagenesis techniques.

In 1995, R. Phillips co-organized a meeting on non-Mendelian inheritance in Japan with K. Oono and, together with M. Matzke, wrote a report for The Plant Cell called “Treasure Your Exceptions” [8]. The

report reviewed discussions on homology-dependent gene silencing, paramutation, epimutations, parental imprinting, somaclonal variation, uniparental genome loss, recombination systems, and other interesting findings that expanded the boundaries of our understanding of gene variation. These boundaries have been further expanded as the field of mutagenesis has transitioned from “Treasure your exceptions” to “Detect and create your exceptions”.

Now it is clear that the mutagenesis research field includes many directed and undirected approaches. Several interesting aspects of ways that gene variation can be detected or modified are briefly highlighted in this report, including *de novo* variation, altering mutant phenotypes through selection, TILLING (Targeted Induced Local Lesions IN Genomes), resequencing, RNAi (RNA interference), mismatch site-specific mutagenesis, homoeologous recombination, forward and reverse genetics via transposable elements, gene replacement, gene addition, and transcriptome modification by mutagenic treatment, aneuploidy, and uniparental chromosome loss.

De novo variation

De novo variation occurs via many pathways. This is variation not present in the parents, but in the progenies, and can be due to naturally occurring point mutations, intragenic recombination, unequal crossing over, transposable elements including the Mutator system, DNA methylation, paramutation, gene amplification, and other means [9]. The variation that is still present in long-term selection experiments may not be due to the variation present in the starting materials but rather the result of *de novo* variation occurring in generations subsequent to the initial cross.

Altering mutant phenotype through selection

Expression of a gene can be modified through selection. R. Phillips’ first exposure to this idea was from H.K. Hayes (personal communication) relative to a maize mutation that has defective tissue between the veins of older leaves resulting in holes and tears, called *ragged*. Hayes had crossed the dominant *Rg1* plants to normal and had continuously selected for modifier genes to the point that the plants were of normal phenotype.

An example important in human nutrition is the selection for hard endosperm in the *opaque2* genotype. This mutation causes an obvious phenotypic visual change in the appearance of the kernel. The endosperm has considerable soft starch making the kernel opaque to light transmitted through the kernel. The *opaque2* genotype was found to cause an increase in the content of lysine and tryptophan, two essential amino acids deficient in maize. Although the nutritional value was obvious, the soft endosperm caused the kernels to crack leading to insect and fungal infections. The mutation also resulted in reduced yield. Researchers recognized that the kernel phenotype could be altered via selection for *o2* modifiers while constantly selecting for the high lysine and tryptophan phenotype. Several generations of selection for hard endosperm in the *opaque2* genotype led to maize lines with good yield and high nutrition [10]. This “Quality Protein Maize” is being grown on nine million acres worldwide.

¹ Regents Professor and McKnight Presidential Chair, University of Minnesota, St. Paul, MN, U.S.A.
² USDA-ARS and Adjunct Professor, University of Minnesota, St. Paul, MN, U.S.A.

* Corresponding author. E-mail: phill005@umn.edu

Recognizing gene variation via new technologies

Plant species, especially polyploids, possess in their genomes considerable variation for specific genes. These often are not recognized because recessive alleles may need to be present in each chromosome (homologous and homoeologous) in order to detect the phenotype. TILLING (Targeted Induced Local Lesions IN Genomes) is a reverse genetic, non-transgenic approach to finding new alleles by DNA assay techniques recognizing changes in the DNA sequence of a targeted gene. In wheat, 246 alleles of the waxy genes were identified by TILLING each homoeologue in 1,920 allohexaploid and allotetraploid individuals [11]. These alleles encode waxy enzymes ranging in activity from near wild type to null. They represent more genetic diversity for a trait in wheat than had been described in the previous 25 years.

Resequencing

DNA resequencing involves sequencing an individual's DNA for a specific region and comparing it to a reference sequence that is already available in order to detect mutations. Resequencing the genome of many individuals allows determination of the relationship between sequence variation and specific phenotypes. This substantially increases the ability to detect gene variation.

In rice, genome-wide SNP (Single Nucleotide Polymorphism) discovery was attempted across the unique sequence fraction of the Nipponbare rice genome. Twenty diverse varieties were selected for resequencing based on geographic representation, diversity, usage, and traits by a group of rice researchers in the OryzaSNP Consortium [12] (www.oryzasnp.org). Overall, the consortium (McNally and Leung, personal communication) found 2.6 SNPs per kb (146,576 genic variants and 112,623 intergenic variants). QTL mapping studies are often restricted due to the absence of known polymorphic sites between parental lines. Having a large number of SNPs reduces this problem by providing information on nucleotide variation between cultivars. Each SNP reflects gene variation.

Directed mutagenesis through regulation of gene expression: RNA interference is a RNA-guided regulation of gene expression utilizing double-stranded ribonucleic acid complementary to the genes for which expression is to be inhibited (Wikipedia). Although a relatively new discovery, RNAi has already been demonstrated to be useful in generating variation for important traits. Root-knot nematode resistance has been produced in *Arabidopsis* [13], delayed senescence in wheat [14], gossypol reduction in cotton seed [15], and cytoplasmic male sterility in tobacco and tomato [16].

Site-specific mutagenesis

An interesting example of site-specific mutagenesis is the use of oligonucleotides with mismatches to the specific gene to be mutated. The company, Cibus LLC, is expected to soon release herbicide resistant sorghum [17]. The company estimates a development cost of about 3-5 million US dollars compared to 30-40 million US dollars for transgenics due to avoiding regulatory hurdles. Such a method of directed mutagenesis is considered to be a non-transgenic approach. This more inexpensive approach may facilitate the generation of new traits in minor crops.

Homoeologous recombination

The *Ph1* locus controls the pairing of the sets of chromosomes in wheat. In crosses with wild relatives, this locus unfortunately prevents the pairing of wheat and the chromosomes of wild relatives making it difficult to introgress new genes into wheat. The ability to alter the control exerted by *Ph1* would enable wheat breeders to access a much greater range of genetic diversity. A *cdc2* gene complex is thought to be the *Ph1* locus responsible for the pairing of homoeologous chromosomes in wheat [18]. Wheat has three genomes that are similar but vary in genetic constitution. Recombination between these similar chromosomes can lead

to new variation. Control of recombination in crosses of wheat with wild relatives may be possible through the use of okadaic acid, a phosphatase inhibitor, and lead to more variation.

Forward and reverse genetics via transposable element insertions

The introduction or activation of transposable elements of various sorts provides the possibility of altering genes to generate phenotypically detectable mutants (forward genetics). The presence of such elements in a gene allows one to correlate these changes in a given genetic sequence with a specific phenotype (reverse genetics). Fortunately, many genetic stocks have been produced in a variety of organisms to make this a robust technology. For example, in rice there are about 50,000 lines with Tos17 insertions produced at the National Institute of Agrobiological resources (<http://tos.nias.affrc.go.jp>). In addition, about 150,000 lines of rice possess *Ac/Ds*, enhancer traps, T-DNA, and activation tags which have been produced by researchers in Korea, Australia, China, Taiwan, France, Singapore, Netherlands, and the U.S. Perhaps a total of a million tagged sites are available in japonica rice [19].

Gene targeting

Targeting specific genes for modification is becoming more and more common. Zinc-finger nucleases can be targeted to specific genes causing a double-stranded break which disables the gene [20, 21]. Zinc finger nucleases are comprised of a DNA-recognition domain and a cleavage domain. The double-strand breaks at specific locations may disable the targeted allele or even lead to a modified sequence upon repair. The potential exists to insert a gene at the double-strand break.

Gene additions

Advances in biotechnology have allowed the addition of genes to plants from almost any source. The generation of transgenic plants has led to 12 years of commercialization of new biotech crops that provide insect resistance, herbicide tolerance, and many other traits and have been grown on over 1.7 billion acres [22]. In India, the eggplant crop is sprayed 80 times a season (nearly every day) in some regions, farmers in other regions spray an average of 40 times, and the most common frequency is more than 20 sprayings (U. Barwale, personal communication). Not only is the consumer exposed to pesticides by such extensive spraying, but also the farmer is more subject to pesticide poisoning. Most of the unintentional chemical poisonings in the developing world are due to pesticides [23]. India has been able to cut pesticide treatment of cotton in half by growing varieties containing introduced Bt (*Bacillus thuringiensis*) insecticidal protein, thereby leading to a safer environment for both producers and consumers [22].

Transcriptome modification

By mutagenesis: A recent paper by Batista, *et al.* [24] reports that Gamma-ray mutagenesis in rice induces extensive transcriptome changes. By microarray analysis, over 11,000 genes showed changes in gene expression in the M_1 generation following gamma irradiation compared to the control. A Gamma-ray-induced semi-dwarf mutant (*Estrella A*), produced in 1988 and subsequently selfed for more than 10 generations, had 51 genes still showing differential expression. Thus, mutants derived from mutagenesis may result in broader boundaries of gene variation (expression) than anticipated.

By aneuploidy: Individuals with other than an exact multiple of the basic chromosome number are called aneuploids and those with only a portion of the chromosome altered in dosage are termed segmental aneuploids. The expectation would be that a gene altered in dosage via aneuploidy would have a corresponding change in gene expression, and that only genes in the aneuploid regions would show changes in expression. Neither of these conclusions is always true. Studies on the human Down's syndrome indicate that many of the genes are on chromosome

21 but several genes with altered gene expression are not, and these may contribute to the syndrome of phenotypic effects [25]. Birchler and Veitia [26] have reviewed many aspects of dosage effects, or lack thereof.

A segmental aneuploid of maize (trisomic for 90% of the short arm of chromosome 5 and monosomic for a small region of the short arm of chromosome 6) deriving from an interchange heterozygote had been utilized in a male-sterility system [27]. Makarevitch, *et al.* [28] determined that only about 40% of the expressed genes in the trisomic region showed the expected 1.5 fold change in gene expression while 60% were not altered in gene expression. Eighty-six genes not in the aneuploid region were found to be altered in expression. The aneuploid condition in the B73 background was found to have leaf outgrowths called knots in later generations (Phillips, personal communication). There are several knotted-like homeobox genes in maize. Out of the nine knotted-like genes tested, only *knox10* located in the chromosome 5 trisomic region was ectopically expressed [28]. Thus, in some cases, the occurrence of developmental phenotypes may be related to unusual expression patterns induced by changes in chromosome constitution.

By uniparental chromosome loss: Crossing wheat with maize followed by embryo rescue [29] led to an efficient means of producing haploid wheat plants [30]. In contrast, crossing oat with maize yields haploids of oat only about two-thirds of the time, and yields plants with the haploid oat chromosome constitution plus one or more maize chromosomes about one-third of the time [31]. The latter plants are termed oat-maize additions (OMAs). Because maize has 10 pairs of chromosomes, there are 10 possible oat-maize addition lines (**Table 1**). We have recovered all 10 OMAs and have several of them in various oat and maize genetic backgrounds (**Table 2**).

The OMA materials have many uses [32]. The principal use is for mapping maize DNA sequences. One of the powerful aspects for mapping is that no polymorphisms are required; the PCR test is plus/minus depend-

ing on whether the sequence is represented on the particular chromosome in an OMA. If there is a related sequence in the oat genome that also is amplified by the PCR, then the maize sequence can be mapped to chromosome if the oat and maize bands are distinguishable. If the maize sequence is part of a gene family, then a PCR band will appear with more than one OMA reflecting the location of gene family members on different chromosomes. Other uses of the OMAs include: chromosome sorting, chromosome pairing studies, comparing repeated sequences on non-homologous chromosomes, checking for chimeric BACs, centromere isolation, and searching for corn traits (such as C4 photosynthesis) in oat.

The phenotypes of the OMAs are generally not dramatically different from the oat parent, although the genotype of the parents often makes a difference. However, OMA chromosome 3 from maize Seneca 60 has a crooked panicle and a *liguleless 3* phenotype where the upper ligules are abnormal. Muehlbauer, *et al.* [33] showed that the phenotype was due to the ectopic expression of *Lg3*. We hypothesize that genes such as *lg3* may be expressed when interacting genes on other chromosomes are not present. In this case, *rs2* (*rough sheath 2*) on chromosome 1 would be absent in OMA 3 and therefore cannot regulate the expression of *lg3* in the addition line. Another interesting case of a mutant appearing in an addition line is the disease lesion mimic phenotype associated with OMA chromosome 6 with the Seneca 60 or B73 chromosome.

The OMAs have been irradiated with Gamma-rays to break the maize chromosome and derive "Radiation Hybrids (RH)" that possess only a part of the maize chromosome, either due to creating a deficient maize chromosome or via a translocation between the maize chromosome and one of the oat chromosomes. In most cases, the translocation event is the more desirable due to higher transmission frequencies [34]. Interestingly, several RH lines were derived from OMA2 and OMA9 that had little more than the maize centromere present and may be useful for maize centromere isolation. RHs with all tested chromosome markers present except for those in deleted terminal segments (either by terminal deletions of the maize chromosome or the presence of only one maize segment translocated to an oat chromosome) are shown in **Table 3**. These stocks should be useful for the deletion mapping of mutations. A complete listing of over 600 RHs can be found at http://agronomy.cfans.umn.edu/Maize_Genomics.html.

Gene-expression microarray analyses of three independent OMA 5 events in the B73 background indicated that at least 17% of the maize chromosome 5 genes expressed in maize B73 seedlings also are expressed in OMA 5 seedlings [35]. All three independent OMA5s expressed the same set of genes. Those expressed were not associated with a specific genome location, predicted function, or methylation state; expression levels in the OMA seedlings were intermediate to that found in B73 maize seedlings (Cabral, personal communication).

Table 1. Available oat-maize addition lines in various maize genetic backgrounds

Maize Chromosome Donor	Oat-Maize Addition Line										B
	1	2	3	4	5	6	7	8	9	10	
Seneca 60	1	11	2	6	3	3	3	2	9	1*	
B73	1	1		3	11	3		1	1	1	
Mo17		8	1*	1	8	3	1*			2	
A188				1			1				
bz1-mum9		1						1			
B73 w/Black Mexican Sweet B Chrom											2

*OMAs for which no seed was produced, but limited DNA of the original plant is available.

Table 2. Parental backgrounds of oat-maize addition lines

Oat Background	Maize Donor										B
	1	2	3	4	5	6	7	8	9	10	
Seneca 60	x	x	x	x	x	x	x	x	x	x	x
B73	x	x		x	x		x		x	x	x
Mo17		x		x	x	x	x				x
A188					x			x			
bz1-mum9		x							x		
B73 w/Bck Mex SweetBs											x

Table 3. Radiation hybrids with terminal deletions or translocations per chromosome

Chromosome 1	
IBM2 Map Site	0.00
	10.50
	32.08
	68.71
	85.20
	97.97
	114.40
	124.70
	143.50
	160.60
	170.00
	198.32
	226.40
	257.40
	279.13
	301.37
	326.70
	358.40
	386.40
	405.00
	417.00
	445.10
	457.00
	464.08
	483.83
	503.30
	521.41
	548.30
	587.00
	598.60
	636.08
	653.40
	662.18
	697.22
	718.50
	747.90
	769.40
	787.49
	800.70
	836.70
	858.39
	874.30
	886.10
	923.01
	933.09
	985.11
	1007.60
	1023.30
	1051.10
	1073.46
	1103.00
	1120.30
	1128.00
	*
	(2)
	(2)
	(1)
	(2)
	(20)
	(2)
	(1)
	(1)
	(4)
	(7)
	(1)

Chromosome 2	
IBM2 Map Site	0.93
	28.10
	47.40
	50.90
	59.90
	92.80
	114.89
	122.40
	143.10
	159.86
	164.80
	179.40
	194.45
	197.20
	227.10
	243.30
	244.70
	269.52
	273.70
	295.10
	310.20
	316.70
	322.19
	339.30
	342.40
	347.00
	357.50
	364.50
	368.80
	369.18
	379.20
	394.52
	398.54
	401.50
	453.80
	453.80
	475.10
	478.70
	480.70
	498.30
	523.50
	525.01
	565.90
	591.50
	600.70
	625.31
	654.80
	674.67
	632.40
	712.10
	*
	(8)
	(12)
	(2)
	(1)
	(2)
	(2)
	(6)
	(1)
	(7)
	(1)
	(6)

Chromosome 3	
IBM2 Map Site	5.60
	7.10
	11.20
	28.20
	38.00
	67.20
	77.00
	103.30
	129.40
	168.10
	165.00
	177.40
	181.70
	189.00
	193.10
	208.60
	259.40
	192.54
	210.40
	276.61
	227.80
	228.50
	238.50
	316.60
	322.19
	234.40
	244.70
	266.00
	195.13
	254.60
	262.90
	269.10
	270.88
	279.30
	280.40
	290.60
	306.10
	313.40
	346.80
	398.40
	401.20
	445.00
	473.10
	491.40
	511.50
	538.20
	544.40
	568.30
	579.50
	617.50
	633.80
	702.20
	738.70
	752.10
	757.00
	806.90
	828.90
	*
	(10)
	(1)
	(6)
	(5)
	(6)
	(1)

Chromosome 4	
IBM2 Map Site	9.00
	29.30
	52.30
	62.20
	85.70
	105.80
	138.80
	148.20
	168.10
	203.70
	211.90
	231.30
	249.10
	263.30
	276.30
	276.30
	292.90
	310.50
	328.90
	352.60
	365.60
	384.50
	393.80
	416.40
	435.70
	447.70
	488.30
	497.90
	508.30
	518.30
	539.00
	546.00
	565.90
	574.30
	604.40
	619.60
	621.30
	637.20
	648.30
	663.10
	679.70
	*
	(4)
	(8)
	(2)
	(1)
	(1)
	(23)
	(1)
	(1)

Chromosome 5	
IBM2 Map Site	0.00
	22.70
	30.00
	40.80
	68.10
	71.90
	97.95
	124.70
	156.90
	160.20
	189.80
	210.30
	240.80
	252.80
	271.50
	286.50
	297.50
	321.00
	328.50
	346.50
	368.40
	377.90
	394.40
	410.80
	428.30
	454.10
	479.70
	493.50
	500.70
	536.60
	559.95
	590.40
	600.00
	609.40
	641.40
	676.70
	*
	(2)
	(13)
	(3)
	(1)
	(3)
	(5)
	(3)
	(1)
	(1)
	(1)
	(1)
	(2)

Chromosome 6		
IBM2 Map Site	17.50	*
	23.20	(26)
	27.60	(4)
	47.80	(2)
	69.20	(8)
	75.80	(1)
	80.70	(1)
	91.90	(1)
	105.90	(4)
	127.80	(3)
	133.40	(3)
	148.70	(1)
	166.80	(1)
	172.35	(8)
	189.50	
	199.00	
	200.30	
	228.90	
	237.05	
	254.50	
	271.50	
	278.00	
	284.40	
	297.10	
	315.40	
	320.70	
	325.09	
	342.13	
	373.80	
	388.70	
	398.50	
	404.40	
	435.10	
	444.20	
	450.70	
	466.50	
	483.50	
	503.40	
	510.60	
	531.80	
	542.70	
		(26)
		(4)
		(2)
		(8)
		(1)
		(1)
		(4)
		(3)
		(3)
		(1)
		(1)
		(4)
		(3)
		(3)
		(1)
		(1)
		(8)
Chromosome 7		
IBM2 Map Site	13.80	*
	53.30	(1)
	92.00	(1)
	123.50	(1)
	127.60	(1)
	153.00	(5)
	153.30	
	180.50	
	188.15	
	169.38	
	190.60	
	244.30	
	258.40	
	274.00	
	286.30	
	298.40	
	315.90	
	331.05	
	351.40	
	365.40	
	376.90	
	387.50	
	410.50	
	430.50	
	444.70	
	449.50	
	455.21	
	494.80	
	518.90	
	547.28	
	558.55	
	593.40	
	600.20	
	600.79	
	611.50	
	644.14	
		(1)
		(1)
		(1)
		(5)
Chromosome 9		
IBM2 Map Site	-39.00	*
	0.00	(41)
	11.80	(1)
	14.00	(6)
	17.70	(1)
	24.30	(1)
	62.30	(1)
	74.80	(1)
	80.30	(12)
	84.30	(10)
	86.80	(15)
	95.80	(2)
	101.10	(3)
	105.80	(1)
	123.68	(1)
	115.01	(1)
	131.10	(1)
	142.60	(1)
	162.50	(1)
	170.40	(1)
	229.10	(1)
	191.70	(1)
	199.70	(1)
	220.10	(1)
	275.16	(1)
	232.80	(1)
	240.50	(1)
	249.20	(1)
	254.00	(1)
	265.68	(1)
	285.80	(1)
	298.00	(1)
	306.78	(1)
	311.50	(1)
	317.78	(1)
	322.60	(1)
	342.00	(1)
	344.00	(1)
	351.20	(1)
	369.00	(1)
	373.20	(1)
	381.10	(1)
	385.30	(1)
	420.67	(1)
	517.50	(1)
	429.70	(1)
	441.20	(1)
	446.17	(1)
	461.60	(1)
	475.87	(1)
	489.90	(1)
	492.30	(1)
	504.60	(1)
	529.04	(1)
	533.58	(1)
	538.50	(1)
	549.39	(1)
	551.30	(1)
	554.40	(1)
	562.70	(1)
	566.80	(1)
	587.60	(1)
	603.50	(1)
	633.20	(1)
	633.60	(1)
	637.10	(1)
	805.14	(1)
		(41)
		(1)
		(6)
		(1)
		(1)
		(1)
		(12)
		(10)
		(15)
		(2)
		(3)
		(1)
		(1)
		(3)
		(1)
		(1)
		(10)
		(5)
		(4)
		(13)
		(11)
		(8)
		(1)
Chromosome 10		
IBM2 Map Site	16.60	*
	30.90	(2)
	44.33	(2)
	59.74	(1)
	76.20	
	91.40	
	97.90	
	120.10	
	155.90	
	187.00	
	199.50	
	225.70	
	242.80	
	260.50	
	277.20	
	290.90	
	299.40	
	306.90	
	335.50	
	380.50	
	392.50	
	410.60	
	444.80	
	445.70	
	456.60	
	469.40	
	483.70	
	505.50	
	513.20	
		(2)
		(2)
		(1)

(*number of break lines)

Conclusions

As with most fields of study, new information and new technologies allow more opportunities for the creation of novel products with various uses. The ability to detect inherent variation has expanded greatly, allowing the detection of more variants within the genome than previously

expected. With genome sequence information and techniques for modifying specific genes, the field of mutagenesis is having a renaissance. Crop improvement will benefit since it depends on gene variation, both natural and induced. Increased food production via the Green Revolution in wheat and rice depended in large part on semi-dwarf mutations. A

current example of gene variation benefiting crop improvement is the naturally occurring *submergence 1* mutation that [36] allows rice to be flooded for up to two weeks with little effect on yield. Understanding the enormous variety of gene interactions in plant species will promote genomic manipulations resulting in interesting variation. Continued research and education on mutagenesis will allow us to realize the ever-increasing potential of gene variation for crop improvement.

BIBLIOGRAPHY

- Bateson, W. The methods and scope of genetics. Cambridge University Press, 22-23 (1908).
- Stadler, L.J. Mutations in barley induced by x-rays and radium. *Science* **68**, 186-197 (1928A).
- Stadler, L.J. Genetic effects of X-rays in maize. *Proc. Natl. Acad. Sci. USA* **14**, 69-75 (1928B).
- Sturtevant, A.H. Essays on evolution. I. On the effects of selection on mutation rate. *Q. Rev. Biol.* **12**, 467-477 (1937).
- Pennisi, E. Genome sequencing: The greening of plant genomics. *Science* **317**, 317 (2007).
- National Research Council. Achievements of the National Plant Genome Initiative and new horizons in plant biology. National Academy Press, Washington D.C., 166 Pages (2007).
- Phillips, R.L. Can genome sequencing of model plants be helpful for crop improvement? 5th International Crop Science Congress, Korea (2008) (<http://www.crops2008.com>).
- Phillips, R.L., Matzke, M.A., Oono, K. Treasure your exceptions. *The Plant Cell* **7**, 1522-1527 (1995).
- Rasmusson, D.C., Phillips, R.L. Plant breeding progress and genetic diversity from de novo variation and elevated epistasis. *Crop Sci.* **37**, 303-310 (1997).
- Bjarnason, M., Vasal, S.K. Breeding of quality protein maize (QPM). Plant Breeding Review, International Maize and Wheat Improvement Center (CIMMYT), Mexico, 192 Pages (1992).
- Slade, A.J., Fuerstenberg, S.I., Loeffler, D., Steine, M.N., Facciotti, D. A reverse genetic, nontransgenic approach to wheat crop improvement by TILLING. *Nature Biotechnol.* **23**, 75-81 (2004).
- McNally, R., Bruskiewich, R., Mackill, D., Buell, C.R., Leach, J.E., Leung, H. Sequencing multiple and diverse rice varieties. Connecting whole-genome variation with phenotypes. *Plant Physiol.* **141**, 26-31 (2006).
- Huang, G., Allen, R., Davis, E.L., Baum, T.J., Hussey, R.S. Engineering broad root-knot resistance in transgenic plants by RNAi silencing of a conserved and essential root-knot nematode parasitism gene. *Proc. Natl. Acad. Sci. USA* **103**, 14302-14306 (2006).
- Uauy, C., Distelfeld, A., Fahima, T., Blechl, A., Dubcovsky, J.A. NAC gene regulating senescence improves grain protein, zinc, and iron content in wheat. *Science* **314**, 1298-1301 (2006).
- Sunikumar, G., Campbell, L.M., Puckhaber, L., Stipanovic, R.D., Rathore, K.S. Engineering cottonseed for use in human nutrition by tissue-specific reduction of toxic gossypol. *Proc. Natl. Acad. Sci. USA* **103**, 18054-18059 (2006).
- Sandhu, A.P.S., Abdelnoor, R.V., Mackenzie, S.A. Transgenic induction of mitochondrial rearrangements for cytoplasmic male sterility in crop plants. *Proc. Natl. Acad. Sci. USA* **104**, 1766-1770 (2007).
- Wenzel, W. Fast-Track Traits. *Farm Journal*, March 17, 2007.
- Griffiths, S., Sharp, R., Foote, T.N., Bertin, I., Wanous, M., Reader, S., Colas, I., Moore, G. Molecular characterization of *Ph1* as a major chromosome pairing locus in polyploidy wheat. *Nature* **439**, 749-752 (2006).
- Phillips, R.L., Odland, W.E., Kahler, A.L. Rice as a reference genome and more. In: 5th Intl. Rice Genetics Symp. (Brar, D.S., Mackill, D. and Hardy, B., Eds.), CD, International Rice Research Institute, Philippines, 3-15 (2007).
- Porteus, M.H., Carroll, D. Gene targeting using zinc finger nucleases. *Nature Biotechnol.* **23**, 967-973 (2005).
- Shukla, F., Arnold, N., Dekelver, R., Doyon, Y., Mitchell, J., Rowland, L., Simpson, M., Worden, S., Urnov, F., Gao, Z. Zinc finger nuclease-mediated gene targeting in maize. In: 50th Annu. Maize Genet. Conf., Washington, D.C. (2008) Abstr. P.37.
- James, C. Global status of commercialized biotech/GM crops: 2007. *Intl. Service For The Acquisition of Agri-Biotech Applications, Brief* **37**, 2007.
- World Health Organization. Deaths from unintentional poisonings. *World Health Report*, Geneva (2004).
- Batista, R., Saibo, N., Lourenco, T., Oliveira, M.M. Microarray analyses reveal that plant mutagenesis may induce more transcriptomic changes than transgene insertion. *Proc. Natl. Acad. Sci. USA* **105**, 3640-3645 (2008).
- Ait Yahya-Graison, E., Aubert, J., Dauphinot, L., Rivals, I., Prieur, M., Golfier, G., Rossier, J., Personnaz, L., Creau, N., Blehaut, H., Robin, S., Delabar, J.M., Potier, M.C. Classification of human chromosome 21 gene-expression variations in Down syndrome: impact on disease phenotypes. *Am. J. Hum. Genet.* **81**, 475-491 (2007).
- Birchler, J.A., Veitia, R.A. The gene balance hypothesis: from classical genetics to modern genomics. *The Plant Cell* **19**, 395-402 (2007).
- Phillips, R.L., Suresh, J. Cytogenetic basis for fertile plants in a maize nuclear male sterility system. *Maydica* **42**, 127-131 (1997).
- Makarevitch, I., Phillips, R.L., Springer, N.M. Profiling expression changes caused by a segmental aneuploid in maize. *BMC Genomics* **9**, 7 (2008).
- Laurie, D.A., Bennett, M.D. Wheat x maize hybridization. *Can. J. Genet. Cytol.* **28**, 313-316 (1986).
- Laurie D.A., Bennett M.D. The production of haploid wheat plants from wheat x maize crosses. *Theor. Appl. Genet.* **76**, 393-397 (1988).
- Kynast, R.G., Okagaki, R.J., Galatowitsch, M.W., Granath, S.R., Jacobs, M.S., Stec, A.O., Rines, H.W., Phillips, R.L. Dissecting the maize genome by using chromosome addition and radiation hybrid lines. *Proc. Natl. Acad. Sci. USA* **101**, 9921-9926 (2004).
- Phillips, R.L., Rines, H.W. Genetic analyses with oat maize addition and radiation hybrid lines. In: Handbook of Maize: Genetics and Genomics, (Bennetzen, J.L. and Hake, S.C., Eds.) Springer-Life Sciences, New York, NY, 523-538 (2009).
- Muehlbauer, G.J., Riera-Lizarazu, O., Kynast, R.G., Martin, D., Phillips, R.L., Rines, H.W. A maize-chromosome 3 addition line of oat exhibits expression of the maize homeobox gene *liguleless3* and alterations of cell fates. *Genome* **43**, 1055-1064 (2000).
- Riera-Lizarazu, O., Vales, M.I., Ananiev, E.V., Rines, H.W., Phillips, R.L. Production and characterization of maize-chromosome 9 radiation hybrids derived from an oat-maize addition line. *Genetics* **156**, 327-339 (2000).
- Cabral, C., Springer, N., Rines, H., Phillips, R.L. Many maize genes are expressed in an oat background carrying a specific maize chromosome. Abstracts, 49th Annu. Maize Genet. Conf., St. Charles, IL, **P.112** (2007).
- Xu, K., Xu, X., Fukao, T., Canlas, P., Maghirang-Rodriguez, R., Heuer, S., Ismail, A.M., Bailey-Serres, J., Ronald, P.C., Mackill, D.J. *Sub1A* is an ethylene-response-factor-like gene that confers submergence tolerance to rice. *Nature* **442**, 705-708 (2006).

Networking and Fostering of Cooperation in Plant Mutation Genetics and Breeding: Role of the Joint FAO/IAEA Division

P J L Lagoda

Abstract

Over the past 50 years, the use of induced mutations (through irradiation and chemical agents) has played a major role in the development of superior crop varieties translating into a tremendous economic impact on agriculture and food production that is currently valued in billions of US dollars and millions of cultivated hectares. For the past 40 years, the International Atomic Energy Agency (IAEA) and the Food and Agriculture Organization (FAO) of the United Nations have through the Joint FAO/IAEA Division of Nuclear Techniques in Food and Agriculture, Vienna, sponsored extensive research and development activities in their Member States on mutation induction to enhance the genetic diversity in the germplasm of food and industrial crops and these efforts have resulted in the official release of over 2,700 new crop varieties in some 170 species to farmers, including rice, wheat, barley, apples, citrus, sugar cane, banana, and others (FAO/IAEA Mutant Variety Database, MVD, <http://www-mvd.iaea.org/MVD/default.htm>). These represent the information submitted voluntarily by FAO and IAEA Member States but one must be aware that thus many more mutants are not registered.

There is no difference between artificially produced induced mutants and spontaneous mutants found in nature. As in traditional cross-breeding, induced mutants are passed through several generations of selfing or clonal propagation, usually through *in vitro* techniques. This is exactly what happens in nature (through evolution) and leads to the fixation of the mutation events. All plant breeders do is mimic nature in this regard. It should also be noted that in most cases, the induced mutants are merely “raw materials,” that in order for their potential to be realized, they must be integrated into established breeding schemes. Thus, mutation induction has proven to be a workable, sustainable, highly-efficient, environmentally acceptable, flexible, unregulated, non-hazardous and a low-cost technology in the breeder’s toolbox to enhance crop improvement.

With increasing recognition of the roles of radiation in altering genomes and phenotypes and of isotopes as detection systems in molecular biology, demands from countries and their institutions for support in various applications of “modern biotechnology” increased dramatically over the last 20 years. Hence support for both R&D (through IAEA Research Contract activities) and for training and capacity building through fellowships, expert services and provision of equipment (through the IAEA Technical Cooperation Programme) in molecular and genomic approaches to solving agricultural constraints have increasingly become part of the technological packages - combining mutation induction and efficiency enhancing bio-molecular technologies - fostered by the Agency in recent years.

The IAEA Programme in Food and Agriculture is planned, implemented and co-financed with FAO and is known as the Joint FAO/IAEA Programme. As such it contributes to “Biotechnology in Food and Agriculture” which is an FAO corporate Priority Activity for

Interdisciplinary Action (PAIA). Moreover, its activities – particularly in crop improvement are conducted in close collaboration with the relevant International Agricultural Research Centres of the CGIAR with which it has a number of Memoranda of Understanding on biotechnology and other applications.

Biotechnology, defined as any technological application that uses biological systems, living organisms or derivatives thereof, to make or modify products or processes for specific use (CBD, 1992), has been at the heart of the IAEA Programme in Food Agriculture since it was established as a joint programme with FAO more than 40 years ago.

The IAEA serves as the global focal point for nuclear cooperation, mobilizing peaceful applications of nuclear science and technology for critical needs in developing countries, including fighting hunger, disease, poverty and pollution of the environment, and thereby contributing to the sustainable development of goals of its Member States.

It should be emphasized that the IAEA does not operate a separate Biotechnology Programme, but rather fosters the integration of modern and conventional bio-molecular technology approaches only where these are considered appropriate for the furthering of nuclear applications (e.g. TILLING).

The IAEA currently coordinates research networks through Coordinated Research Projects (CRPs) and supports human and institutional capacity building Technical Cooperation Projects (TCPs) for integrating plant tissue culture techniques, advanced molecular methods and induced mutations within the framework of national plant breeding and conservation programmes to characterize plant genetic resources, widen plant genetic diversity, and identifies and introduces agronomically and commercially useful traits.

What are nuclear techniques?

Everything in the universe including soil, plants and animals that we use for agriculture and carbohydrates, proteins and fats in the food we eat is made up of around 100 elements. These elements consist of atoms with a nucleus composed of neutrons and protons surrounded by electrons. However, not all atoms of an element have the same number of neutrons in their nucleus i.e. they exist in different isotopic forms- some are heavier than others, some are stable while yet others undergo decay and emit energy as radiation.

Applications of nuclear techniques in food and agriculture make use of isotopes to measure and track with great accuracy and precision what is happening to agriculturally important processes and compounds, and to manipulate these for greater productivity. They also make use of sealed sources containing radiation-emitting isotopes to mimic nature in changing the genetic make-up of plants, insects and micro-organisms and produce better crops, sterile insects for controlling pests and increasing the shelf-life and safety of certain foods.

Nuclear techniques, combined with the application of modern biotechnology, are essential for providing a more efficient means, both for understanding the processes that underpin the production and transformation of biophysical resources into food and agricultural products,

Section Head Plant Breeding & Genetics, Joint FAO/IAEA Programme, IAEA, Vienna, Austria
E-mail: P.Lagoda@iaea.org

and directly or indirectly, for manipulating these processes to increase crop and livestock productivity while conserving and sustainably using natural resources and improving food quality and safety. The effective transfer of existing nuclear techniques to developing countries and the development of new and safe biotechnologies combined with nuclear techniques can greatly enhance the prospects for sustainably improving agricultural productivity today and in the future.

Mutation induction and breeding

The prime strategy in mutation-based breeding has been to upgrade the well-adapted plant varieties by altering one or two major traits, which limit their productivity or enhance their quality value. The global impact of mutation-derived varieties on food production and quality enhancement is difficult to monitor, even in a five-year window, given that normally the release of a new variety takes 10 to 15 years. Looking back on the past 70 years, close to 3,000 varieties have been released worldwide that have been derived either as direct mutants or from their progenies. Induction of mutations with radiation has been the most frequently used method for directly developed mutant varieties. Part of this success might be rightfully claimed by the Agency, either directly or indirectly through Technical Cooperation Projects (TCPs) and Coordinated Research Projects (CRPs), fellowship training, organized scientific visits and expert missions.

Officially released mutation-derived varieties include many important crops such as rice, wheat, cotton, rapeseed, sunflower, sesame, grapefruit and banana. Among these, some have made a major economic impact and include rice varieties in Australia, China, India, Pakistan, Thailand and Vietnam, cotton in Pakistan, Japanese pear in Japan, grapefruit in the USA, barley varieties in Europe, durum wheat in Italy, sunflower in the USA, sorghum in Mali and wheat varieties in the North-Western Frontier Province in Pakistan; groundnut and pulse crops in India, peppermint in the USA, and ornamentals in India, the Netherlands and Germany.

In several mutation-derived varieties, the changed traits have resulted in a synergistic effect on increasing the yield and quality of the crop, improving agronomic inputs, crop rotation, and consumer acceptance.

The economic value of a new variety can be assessed through several parameters. These include area planted to the variety and percentage of the area under the crop in the region, increased yield, enhanced quality, reduced use of pesticides and fungicides (e.g. in varieties resistant to diseases and insect pests). But to make a long and complicated story short, a review of the socio-economic impact of mutant varieties has been recently published by the PBG section, reporting on millions of hectares cultivated and an additional value of billions of dollars created.

Many mutants have made a transnational impact on increasing yield and quality of several seed propagated crops. Induced mutations will continue to play an increasing role in creating crop varieties with traits such as modified oil, protein and starch quality, enhanced uptake of specific metals, deeper rooting system, and resistance to drought, diseases and salinity as a major component of environmentally sustainable agriculture. Future research on induced mutations will also be important in the functional genomics of many food crops.

The Agency has addressed the problems of drought, salinity and stress tolerance to improve nutrition provided by the plants and to their resistance to specific environmental and geographical problems. Up to 80% of plant yield can be lost because of drought and salinity. Problems are particularly severe in developing countries in arid and semi-arid regions, with both devastating short-term effects on the livelihoods of poor people and long-term effects on food security, and are likely to increase in the future as competition for water increases. The integration of mutation induction and efficiency enhancing bio-molecular technologies into plant breeding and adoption of advanced selection methods can lead to the official release and wide uptake by farming communities of new

varieties of basic food and industrial crops that are higher yielding, have better quality, are more nutritious, which are better adapted to climate change and variability.

With the integration of molecular genetic information and techniques, mutation breeding is in the mainstream of progress to develop novel varieties. Mutation induction combined with bio-molecular technologies such as plant tissue culture and molecular markers plays a very important role in crop improvement. Mutation induction is an integral part of the newest technology package in the forefront of modern and efficient methods in reverse genetics and breeding: TILLING (targeting induced local lesions in genomes), e.g. breeding hexaploid wheat for quality traits (starch). Mutation induction is producing mutation grids for gene discovery and gene function analyses (e.g. *Arabidopsis*, rice and barley), an invaluable resource for genomics, reverse and forward genetics.

- There have been more than 2,700 officially released mutant varieties from 170 different plant species in more than 60 countries throughout the world.
- Over 1,000 mutant varieties of major staple crops enhance rural income, improve human nutrition and contribute to environmentally sustainable food security in Asia. Vast numbers of induced mutant varieties are developed with the Agency's assistance, including support on mutant germplasm exchange and dissemination in Asia and around the world.
- Worldwide, more than 60% of all mutant varieties were officially released after the year 1985, in the era of biotechnology in plant breeding. The integration of mutation techniques and efficiency-enhancing bio-molecular techniques that permit rapid selection of the most beneficial mutants has pushed the use of mutation induction to new and higher levels of applicability.
- In vegetatively propagated crops, where genetic variation is difficult to obtain due to limited sexual reproduction due to sterility and polyploidy, mutation induction is a tool of choice to be promoted. Mutation induction allows for escaping the deadlock of sterility and parthenocarpy by creating useful variants.

In recent years there has been increased interest in understanding the genome. This goes in parallel with the explosion of fundamental and strategic research to understand gene structure and function, especially in crop and model plants. The IAEA Plant Breeding and Genetics section and laboratory unit are adapting the TILLING strategy to the peculiarities of tropical orphan crops. In addition to the work on the relatively more studied crop, rice, the Joint Programme has made significant progress in the development of protocols, i.e. simplifying procedures and exploring low cost options, facilitating the use of TILLING to routinely query the genomes of the scantily studied polyploid and vegetatively propagated crops that are important to the food security and livelihoods of Member States such as cassava and bananas, thus creating an invaluable resource for reverse genetics and breeding for the global community. The widespread routine adoption of TILLING, for instance, will significantly reduce the costs and time invested in the development of superior crop varieties.

Nuclear Applications in Food and Agriculture as exemplified by the activities of the Joint FAO/IAEA Programme

On 1 October, 1964, the Food and Agriculture Organization of the United Nations (FAO) and the International Atomic Energy Agency (IAEA) created the Joint FAO/IAEA Division of Nuclear Techniques in Food and Agriculture with the first arrangements concluded by directors general of both Organizations. The goal was to bring the talents and resources of both organizations into assisting their Member States in applying nuclear techniques for providing people with more, better and safer food and other agricultural products, while sustaining the natural resources base.

Over four decades, Joint Division activities have evolved to respond to the ever-changing landscape of agriculture and nuclear technology and the expectations of national and international organizations for cooperation in nuclear research and technology transfer. Throughout this process, the Division has successfully remained at the forefront of assisting countries in fostering the uses of nuclear science and technology where these really add value. Today, the Joint Division strives to mobilize commitment and action to meeting the World Food Summit and Millennium Development Goals of reducing hunger, poverty and environmental degradation through sustainable agriculture and rural development.

An important part of this Programme is the FAO/IAEA Agriculture & Biotechnology Laboratory, set up to provide applied research, services and training to member countries. The arrangements on the Joint FAO/IAEA Programme of Nuclear Techniques in Food and Agriculture were revised in 1997 and signed by the Directors General of FAO and IAEA in December 2001.

The Joint FAO/IAEA Programme includes three interdependent components:

- The Joint FAO/IAEA Division in Vienna, which provides normative and technology transfer support, coordinates research networks, policy advice and public information activities to Member States.
- The FAO/IAEA Agriculture and Biotechnology Laboratory in Seibersdorf, which provides applied research, services and training to member countries, and serves as reference centre.
- Food and agriculture projects under the IAEA Technical Cooperation Programme, which manages the implementation of operational activities in member countries.

The Joint Programme continues to be a successful model of cooperation within the UN System, providing necessary assistance to the needs of Member States in the peaceful application of nuclear techniques in food and agriculture.

High priority activities of the Joint FAO/IAEA Programme focus on three thematic areas, i.e. (i) productivity enhancement; (ii) plant, animal and consumer protection; and (iii) the conservation and sustainable use of natural resources. The Joint FAO/IAEA Programme, which includes the FAO/IAEA Agriculture and Biotechnology Laboratory, continues to contribute to different programme chapters (Crop Production Systems Management, Pest of Animals and Plants, as well as Nutrition and Consumer Protection) by integrating policy advice, capacity building, R&D, as well as normative and operational technical support to the application in Member States of nuclear techniques.

In general, nuclear techniques are essential to providing unique support for these programme chapters, and are the only solution in certain areas. The necessity for nuclear applications lies first in their capacity to bring about changes into the genetic make-up of plants, and to offer great potential to increase the biodiversity of crop plants. Furthermore, the need for nuclear applications also lies in their unique sensitivity and specificity as markers. They can be used to measure – with a greater accuracy than is possible by any other conventional method – basic, and yet strategically essential processes which take place within and between soils, plants, and animals. Finally, radiation can be effectively applied for sanitary and phytosanitary purposes in support of food safety and can facilitate international agricultural trade, as well as specialized applications such as the sterile insect technique, a process whose leadership lies with the Joint FAO/IAEA Programme.

Crop Production Systems Management focuses on the enhancement and sustainability of crop production systems and the conservation and use of plant genetic resources together with sustainable seed production.

By using mutation induction, isotope tracer and radio-nuclide fallout techniques, the Joint FAO/IAEA Programme provides unique support to this programme chapter:

- Using the mutation induction techniques, an abundance of plant mutants have been created, which not only increase biodiversity, but are also used by modern biotechnology, and provide breeding material for conventional plant breeding, thus directly contributing to the conservation and use of plant genetic resources.
- Through mutation breeding, member countries may directly develop new high-yielding cultivars with good agronomic characteristics such as disease resistant, well-adapted and high value-added traits, which is difficult or impossible to attain through conventional plant breeding from any germplasm source including local landraces. This helps to enhance crop production for food security, increase farmer income and conserve biodiversity.
- Isotope tracer techniques characterize agriculturally important processes between water, soils and plants. The use of isotope techniques contributes to the improvement of crop water productivity, enhancement of soil fertility and minimization of land and water degradation, thus making cropping systems more productive and sustainable.
- Spatial and temporal distribution of fallout and naturally occurring radio-nuclides provide a reliable means of measuring soil erosion and sedimentation on a landscape scale and contribute to better soil and water conservation.

Diseases and Pests of Animals and Plants highlights the control of transboundary pest and disease threats to crop and livestock with focus on off-farm technical interventions for pest and disease control at global, regional and national levels.

The sterile insect technique (SIT) and isotope and related biotechnological methods (RIA, ELISA, PCR and molecular markers), when appropriately integrated with other methodologies, provide substantial added value to national and international efforts to enhance livestock productivity and protect human health and the environment through more effective feed and genetic resource utilization, breeding management and suppression or eradication of both trade and poverty related transboundary animal diseases (TADs) and plant pests. This also includes the production of guidelines and manuals, databases, policy advice and standard-setting, training materials and e-learning modules, early detection methods and quality-assured data from national serological and molecular surveys in support of the diagnostic, surveillance and analytical aspects of the programme. The Joint FAO/IAEA Programme contributes specifically in the following ways:

- Improves livestock productivity using gene-based technologies to optimise reproduction and breeding and nutrition strategies; e.g. isotopic tracing to optimise nutrition elements, radio immuno tracers and markers to optimise artificial insemination/birth frequency.
- Develops and applies nuclear and nuclear-related molecular technologies for early, rapid and sensitive diagnosis and cost-effective characterization of animal and human pathogens (such as HPAI), and the development of stable isotopic applications for the movement/origin tracing of animals and animal products.
- Develops and integrates the application of the sterile insect technique against key insect pests of agricultural and environmental importance.
- Facilitates country access to molecular tools and insect pest population genetics to develop improved insect pest control methods and to determine the origin of pest outbreaks.
- Provides support to national plant health services within biosecurity approaches for pests of national and regional quarantine importance, as well as off-farm technical interventions to prevent, eradicate, contain or suppress invasive, alien and emerging major insect pests.
- Collaborates with the International Plant Protection Convention Secretariat on the development and revision of standards on beneficial insects, fruit fly free and low prevalence areas and systems approaches to facilitate international trade of horticultural products.

Nutrition and Consumer Protection focuses on promoting and monitoring the production, processing, distribution and consumption of nutritionally adequate and safe food for all. The programme promotes the establishment of food control and quality assurance systems, compatible with international standards, in particular those of the Codex Alimentarius Commission, and contributes to building national capacities in food quality and safety.

Food irradiation is one of the few technologies which address food quality and safety by virtue of its ability to control spoilage and food-borne pathogenic micro-organisms and insect pests without significantly affecting sensory or other attributes. In addition, nuclear analytical methods such as electron capture gas chromatography, X-ray fluorescence and RIA coupled with the use of isotopically-labelled compounds are essential components of the armoury used by food control organizations for analysing food samples (e.g. for pesticides and veterinary drug residues), for compliance with Codex standards, as well as for improving sampling and analytical methods. Through the use of these nuclear techniques, the Joint FAO/IAEA Programme provides unique support to FAO and other international bodies in their efforts to enhance food quality and safety, protect consumer health and facilitate international trade in foodstuffs. The following are examples of the Joint FAO/IAEA Programme's work:

The development and use of nuclear-related methods of analysis for the determination, monitoring and control of pesticide and veterinary drug residues in foods, as well as in the finalization of Codex Guidelines for the Use of Mass Spectrometry and for the Estimation of Uncertainty of Results.

- Joint FAO/IAEA Programme assistance in the development and application of Codex standards to ensure food safety, which has also led to an increased use of food irradiation for over 60 different types of foodstuffs (spices, grains, chicken, beef, seafood, fruits and vegetables) in over 60 countries, resulting in the annual treatment of 500,000 metric tons of foods in over 180 gamma radiation facilities.

Collaboration with the International Plant Protection Convention Secretariat, expanding the use of irradiation for quarantine purposes, including in the identification of 12 specific phytosanitary treatments and one generic dose (fruit flies) recommended for adoption and subsequent inclusion into the IPPC Guidelines for the Use of Irradiation for Phytosanitary Purposes.

- The Joint FAO/IAEA Programme also looks forward to its continued collaboration with FAO in assisting its Member States to effectively prepare and respond to nuclear emergencies affecting food and agriculture, especially through the application of the jointly developed Codex Guideline Levels for Radio-nuclides in Foods.

All major activities of the Joint Programme are within the 'public goods' area, both in developing and developed countries and address urgent needs and requirements from FAO and IAEA Member States. In addition, many constraints to agricultural development related to the above thematic areas, especially animal and crop pests and diseases, are transboundary in nature and require an area-wide approach to be managed successfully. Regional collaboration is therefore necessary and collaboration between international organizations is best positioned to coordinate these activities. In that respect, the Joint FAO/IAEA Programme has also made significant contributions that need to be highlighted:

- Tens of millions of hectares of higher-yielding or more disease-resistant crops developed through induced mutations and released to poor farmers.
- Millions of tons of valuable topsoil and thousands of tons of plant nutrients, as well as water for crop and livestock production are saved from land degradation, soil erosion and water wastage through soil conservation measures and efficient land and water management.

- Thousands of plant mutants produced by Joint Programme not only increased biodiversity, but also provided breeding material for conventional plant breeding, thus directly contributing to the conservation and use of plant genetic resources.
- Control of major livestock disease vector and plant pest populations through the integrated application of the sterile insect technique and biological control agents.
- Near eradication of the fatal cattle disease rinderpest, aided by the widespread use of immunoassay technology developed and transferred to diagnose and monitor vaccination against the disease, has helped millions of poor livestock producers worldwide. In Africa alone, this brings benefits of 1 billion US dollars annually.
- The development of animal disease diagnostic tools (and those of zoonotic nature) to ensure the sensitive, rapid and quality assured detection of harmful pathogens.
- Elaboration of international standards on pre-harvest and harvest pest control, including the irradiation of foods and agricultural products to kill pathogens and insect pests. More than 50 countries are using food irradiation to ensure the safety and quality of food, for reducing post-harvest food losses and to satisfy international plant quarantine regulations.
- Eradication of tsetse fly in Zanzibar, screwworm in Libya, Mediterranean fruit fly in Chile, California, Mexico, and parts of Argentina and Peru, representing hundreds of millions US dollars in economic, trade-related and environmental benefits.
- Policy advice is provided through expert support, country programme framework, steering committees, guidelines and international legislation.

Over the past decade, the Joint Programme annually contributes to capacity building through over 50 training courses and workshops, 350 fellowships and scientific visits, and has over 500 national institutions participating in R&D networks. Through the regular budget, the Joint Programme organizes symposia, conferences, consultants meetings, interregional training courses and workshops, provides normative and policy advice, disseminates information through databases, e-learning modules and Web pages, and assists Member States through a network of coordinated research projects (CRP) and research coordination meetings (RCM) to address specific practical problems related to a range of areas.

Through IAEA-Technical Cooperation (TC) funding, the Joint FAO/IAEA Programme provides technical support to more than 250 IAEA-TC projects every year, as well as capacity building and technology transfer (expert advice, training, and assisting with the procurement of experts and equipment) to Member States through these technical cooperation projects.

Approximately 400-500 institutions and experimental stations in Member Countries cooperate in 30-40 Coordinated Research Projects per year organized by Joint FAO/IAEA Programme.

The FAO/IAEA Agriculture & Biotechnology Laboratory (ABL) is unique within the UN system in that it provides hands-on training and gives participants the opportunity to accelerate capacity building in their respective countries. The training programme is developed based on the demand for expanding expertise in developing countries.

The IAEA is the only organization within the UN family that has the mandate to promote the peaceful use of nuclear techniques. In some of the agricultural areas, nuclear techniques are an essential component, and when properly integrated with other conventional technologies, provide substantial added value to national and international efforts for sustainable agricultural development while at the same time creating strong synergies. The Joint FAO/IAEA Programme is the only international body that can provide technology development and transfer, capacity building and services in this area to the Member States and is in this respect unique.

Plenary Session 1

Induced Mutations in Food and Agriculture

The Role of Induced Mutations in World Food Security

M C Kharkwal^{1,*} & Q Y Shu²

Abstract

Physical availability and economic accessibility of food are the most important criteria of food security. Induced mutations have played a great role in increasing world food security, since new food crop varieties embedded with various induced mutations have contributed to the significant increase of crop production at locations people could directly access. In this paper, the worldwide use of new varieties, derived directly or indirectly from induced mutants, was reviewed. Some highlights are: rice in China, Thailand, Vietnam, and the USA; barley in European countries and Peru, durum wheat in Bulgaria and Italy, wheat in China, soybean in China and Vietnam, as well as other food legumes in India and Pakistan. An exact estimate of the area covered by commercially released mutant cultivars in a large number of countries is not readily available, but the limited information gathered clearly indicates that they have played a very significant role in solving food and nutritional security problems in many countries.

Introduction

Ever since the epoch-making discoveries made by Muller [1] and Stadler [2] eighty years ago, a large amount of genetic variability has been induced by various mutagens and contributed to modern plant breeding. The use of induced mutations over the past five decades has played a major role in the development of superior plant varieties all over the world (Fig. 1a). Among the mutant varieties, the majority are food crops (Fig. 1b).

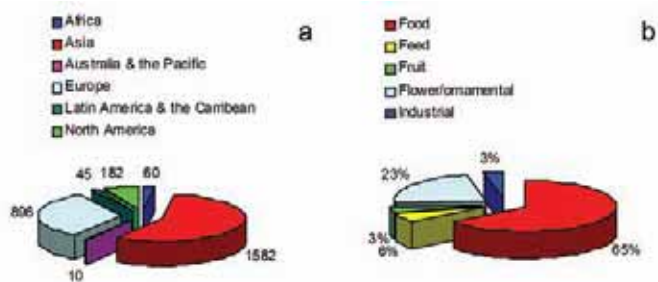

Figure 1 Plant varieties derived from induced mutants. a) The number of mutant varieties in different continents and b) proportion of various plant types Source: FAO/IAEA Database of mutant varieties and genetic stock, <http://mvg.iaea.org>, 17 November, 2008.

Food security has been variously defined in economic jargon, but the most widely accepted definition is the one by the World Bank [3] – “access by all people at all times to enough food for an active, healthy life”. Likewise, the World Food Summit at Rome in 1996 also known as Rome

Declaration on World Food Security [4] on food plan action observed that, “Food security at the individual, household, national and global level exists where all people at all times have physical and economic access to sufficient, safe and nutritious food to meet their dietary needs and food preferences for an active and healthy life”. In both definitions, emphasis has been given to physical availability and economic accessibility of food to the people. The mutant varieties are often grown by farmers in their fields, and any increase of food production resulted from the cultivation of the mutant varieties could be translated into increased food security, since this should be accessible for the people in need.

A detailed review on the global impact of mutation-derived varieties developed and released in major crops all over the world has been published by Ahloowalia, *et al.* [5]. Several papers presented in this Symposium have also elaborated the contribution of induced mutations to food security in either a particular country or a particular crop. Herewith, we present the overall role of induced mutations worldwide, by continent and country, with emphasis on those countries not already discussed in papers which are included in this book.

ASIA

According to the FAO/IAEA database [6], more than half of the mutant derived varieties were developed in Asia (Fig. 1); China, India, and Japan are the three countries that released the largest number of mutant varieties in the world. Some important achievements are summarized here.

China

In China, the mutant rice variety ‘Zhefu 802’ deriving from var. ‘Simei No. 2’, induced by Gamma-rays, has a short growing period (105 to 108 days), high yield potential even under poor management and infertile conditions, wide adaptability, high resistance to rice blast, and tolerance to cold [5]. Therefore, it was the most extensively planted conventional rice variety between 1986 and 1994. Its cumulative planted area reached 10.6 million ha during that period [7]. Two other mutant rice varieties, Yuanfengzao (1970’s) and Yangdao # 6 (2000’s), developed and released before and after Zhefu 802, are further mutant varieties that had been grown on annual scales up to one million ha (Ministry of Agriculture, China, unpublished data). Using a pollen irradiation technique, two new high-quality, high-yield, and early maturity mutant varieties – Jiahezazhan and Jiafuzhan, resistant to blast and plant-hopper, as well as endowed with a wide adaptability - were developed and are now planted annually on 363,000 ha in Fujian province of China [8].

China has also been successful in breeding soybean varieties using mutation techniques. For example, the mutant soybean varieties developed by the Genetics Institute of the Chinese Academy of Sciences possess different excellent traits such as high yield, good grain quality, disease/insect resistance, or drought/salt tolerance. The total area planted with these varieties was more than 1×10^7 ha. [9]. The “Henong series” soybean mutant cultivars, developed and released by the Soybean Institute of Heilongjiang Academy of Agricultural Sciences, as well

¹ Division of Genetics, Indian Agricultural Research Institute, New Delhi 110 012, India

² Joint FAO/IAEA Division of Nuclear Techniques in Food and Agriculture, International Atomic Energy Agency, Vienna, Austria

* Corresponding author. E-mail: mckharkwal@gmail.com

as another variety, Tiefeng18, were grown on an area of more than 2.33×10^6 ha and 4×10^6 ha respectively (Ministry of Agriculture, China, unpublished data).

China has developed and released a large number of high yielding groundnut mutant varieties during the last few decades. The cumulative cultivated area of the more than 35 mutant cultivars released accounts for about 20% of the total area under groundnut in China [10].

Table 1. Number of released mutant varieties in 57 crop species in India

SN	Latin name	Common name	No. of varieties
1	<i>Ablemoschus esculentus</i> L. Moench	Okra	2
2	<i>Arachis hypogaea</i> L.	Groundnut	18
3	<i>Bougainvillea spectabilis</i> Wild	Bougainvillea	13
4	<i>Brassica juncea</i> L.	Mustard	9
5	<i>Cajanus cajan</i> L. Millsp.	Pigeonpea	5
6	<i>Capsicum annuum</i> L.	Green pepper	1
7	<i>Carica papaya</i> L.	Papaya	1
8	<i>Chrysanthemum</i> sp.	Chrysanthemum	49
9	<i>Cicer arietinum</i> L.	Chickpea	8
10	<i>Corchorus capsularis</i> L.	White jute	2
11	<i>Corchorus olitorius</i> L.	Tossa jute	3
12	<i>Curcuma domestica</i> Val.	Turmeric	2
13	<i>Cymbopogon winterianus</i> Jowitt.	Citronella	9
14	<i>Cyamopsis tetragonoloba</i> L.	Cluster bean	1
15	<i>Dahlia</i> sp.	Dahlia	11
16	<i>Dolichos lablab</i> L.	Hyacinth bean	2
17	<i>Eleusine coracana</i> L.	Finger millet	7
18	<i>Gladiolus</i> L.	Gladiolus	2
19	<i>Glycine max</i> L. Merr.	Soybean	7
20	<i>Gossypium arborium</i> L.	Desi cotton	1
21	<i>Gossypium hirsutum</i> L.	American cotton	8
22	<i>Helianthus annuus</i> L.	Sunflower	1
23	<i>Hibiscus sinensis</i> L.	Hibiscus	2
24	<i>Hordeum vulgare</i> L.	Barley	13
25	<i>Hyocymus niger</i>	Indian henbane	1
26	<i>Lantana depressa</i> L.	Wild sage	3
27	<i>Lens culinaris</i> L. Medik.	Lentil	3
28	<i>Luffa acutangula</i> Roxb.	Ridged gourd	1
29	<i>Lycopersicon esculentum</i> M.	Tomato	4
30	<i>Matricaria cammomilla</i>	German chamomile	1
31	<i>Mentha spicata</i>	Spearmint	1
32	<i>Momordica charantia</i> L.	Bitter gourd	1
33	<i>Morus alba</i> L.	Mulberry	1
34	<i>Nicotiana tabacum</i> L.	Tobacco	1
35	<i>Oryza sativa</i> L.	Rice	42
36	<i>Papaver somaniferum</i> L.	Opium poppy	2
37	<i>Pennisetium typhoides</i> L.	Pearl millet	5
38	<i>Phaseolus vulgaris</i> L.	French bean	1
39	<i>Pisum sativum</i> L.	Pea	1
40	<i>Plantago ovata</i> L.	Isabgol	2
41	<i>Polyanthus tuberosa</i> L.	Tuberose	2
42	<i>Portulaca grandiflora</i> L.	Portulaca	11
43	<i>Ricinus communis</i> L.	Castor	4
44	<i>Rosa</i> sp.	Rose	16
45	<i>Sachharum officinarum</i> L.	Sugarcane	9
46	<i>Sesamum indicum</i> L.	Sesame	5
47	<i>Setaria italica</i> L.	Foxtail millet	1
48	<i>Solanum khasianum</i> Clarke	Khasianum	1
49	<i>Solanum melongena</i> L.	Brinjal	1
50	<i>Solenostemon rotundifolius</i>	Coleus	1
51	<i>Trichosanthes anguina</i> L.	Snake gourd	1
52	<i>Trifolium alexandrinum</i> L.	Egyptian clover	1
53	<i>Triticum aestivum</i> L.	Wheat	4
54	<i>Vigna aconitifolia</i> Jacq. M.	Moth bean	5
55	<i>Vigna mungo</i> L. Hepper	Blackgram	9
56	<i>Vigna radiata</i> L. Wiczeck	Mungbean	15
57	<i>Vigna unguiculata</i> L. Walp.	Cowpea	10
	Total		343

India

In India, sustained efforts for crop improvement through induced mutations were initiated during the second half of the 1950s, although the world's very first mutant variety of cotton, MA-9 induced by X-rays, endowed with drought tolerance, was released in 1948 by India [11]. The Indian Agricultural Research Institute (IARI) in New Delhi; Bhabha Atomic Research Center (BARC) in Mumbai, Tamil Nadu Agricultural University (TNAU) in Coimbatore, and the National Botanical Research Institute (NBRI) in Lucknow, are some of the major research centers actively engaged in mutation breeding for several crops and have contributed substantially to the development and release of a large number of mutant varieties. Kharkwal, *et al.* [11] in 2004 listed a total of 309 mutant cultivars of crops, belonging to 56 plant species that were approved and/or released in India by the end of the twentieth century. An updated list of 343 mutant cultivars released in India is given in **Table 1**. The largest number of mutant cultivars have been produced in ornamentals (119), followed closely by legumes (85) and cereals (74).

The mutant cultivars have contributed immensely in augmenting the efforts of Indian plant breeders in achieving the target of food self-sufficiency and strong economic growth. Mutation breeding has thus significantly contributed to the increased production of rice, groundnut, chickpea, mungbean, urdbean, and castor in the Indian sub-continent. While authentic information on the area covered under these cultivars is unfortunately lacking in general, some data is available as summarized below.

The mungbean varieties Co-4, Pant Mung-2, and TAP-7, though released in the early 1980s, are still being grown widely around the country. The variety TARM-1, resistant to powdery mildew and YMV diseases, is the first of its kind to be released for *rabi*/rice fallow cultivation. Four of the nine mutant varieties of blackgram (urdbean) released in India have been developed at the Bhabha Atomic Research Centre (BARC) in Mumbai. One of these mutant varieties, TAU-1, has become the most popular variety in Maharashtra State, occupying an area of about 500,000 hectares (over 95% of the total area under urdbean cultivation in Maharashtra). Since 1990, the Maharashtra State Seed Corporation, Akola, has distributed about 200,000 quintals of certified seeds of TAU-1 to the farmers, which has resulted in an additional production of about 129,000 quintals of urdbean annually in Maharashtra. The notional income generated by additional production amounts to Rs. 300 crores (about 60 million US dollars) annually [11].

Several high-yielding rice mutants were released under the 'PNR' series; some of these were also early in maturity and had short height [12]. Among these, two early ripening and aromatic mutation-derived rice varieties, 'PNR-381' and 'PNR-102', were very popular with farmers in Haryana and Uttar Pradesh States. No data is available on the actual area planted with these varieties. However, based on the rate of fresh seed replacement by farmers and the distribution of breeder seed, foundation seed, and certified seed, as well as on the basis of data obtained from IARI, the value of rice (paddy) production would be 1,748 million US dollars per year [5].

Chickpea: The four high yielding and Ascochyta blight and wilt disease resistant chickpea mutant varieties Pusa - 408 (Ajay), Pusa - 413 (Atul), Pusa - 417 (Girnar), and Pusa - 547, developed at I.A.R.I., New Delhi, and released by the Indian government for commercial cultivation, are the first examples of direct use of induced micro-mutants in a legume crop in the world. Beside high yield performance under late sown crop, chickpea mutant variety Pusa - 547, released in 2006 for farmers' cultivation, has attractive bold seeds, thin testa, and good cooking quality [11, 13, 14, 15].

The success of mutant varieties released is also evident from the large quantities of breeder seed of several mutant varieties at the national level (**Table 2**).

The release of 'TG' (Trombay groundnut) cultivars of groundnut in India has contributed millions of dollars to the Indian economy. Detailed information on the great success of mutation breeding of groundnut and legumes, as well as their contribution to food security in India, can be found in another paper in this book [16].

Table 2. Breeder seed (BS) production of mutant varieties in India (2003–2008)

S.No.	Crop	Mutant variety	BS (kg)	Period
1	Groundnut	TAG-24	427,500	5 yr
2	Groundnut	TG-26	78,600	5 yr
3	Groundnut	TPG-41	37,100	2 yr
4	Barley	RD-2035	53,600	4 yr
5	Soybean	NRC-7	50,200	5 yr
6	Chickpea	Pusa-547	9,100	1 yr

Japan

More than 200 direct-use mutant varieties generated through gamma irradiation, chemical mutagenesis, and somaclonal variations, have been registered in Japan [17]. About 61% of these were developed through mutation induction by Gamma-ray irradiation at the Institute of Radiation Breeding. In 2005, two direct-use cultivars and 97 indirect-use cultivars made up for approximately 12.4% of the total cultivated area in Japan. More information about mutant varieties and their contribution to food production in Japan is available in Nakagawa's paper in this book [17].

Thailand

The contribution of induced mutation to food production in Thailand is best reflected by the work on rice. Two aromatic *indica* type varieties of rice, 'RD6' and 'RD15', released in 1977 and 1978 respectively, were derived from gamma irradiated progeny of the popular rice variety 'Khao Dawk Mali 105' ('KDML 105'). RD6 has glutinous endosperm and retained all other grain traits, including the aroma of the parent variety. RD15, on the other hand, is non-glutinous and aromatic like the parent, but ripens 10 days earlier than the parent, which is a major advantage for harvesting before the onset of the rainy season in the respective areas. Even 30 years after their release these two varieties are still grown extensively in Thailand, covering 80% of the rice fields in north-eastern Thailand. According to the Bureau of Economic and Agricultural Statistics, during 1995-96, RD 6 was grown on 2,429,361 ha, covering 26.4% of the area under rice in Thailand, producing 4,343,549 tons paddy [5, 18], and in 2006 was still cultivated on an area of more than one million ha (S. Taprab, personal communication, July 2007). Thailand is the largest exporter of aromatic rice to the world market. Thus, the impact of the two rice mutant varieties is far beyond the farm gate with a major contribution to the export earnings. Between 1989 and 1998, the contribution of RD6 paddy was 4.76 billion US dollars, of milled rice 15.3 billion US dollars, and that of RD15 485.6 million US dollars for paddy, and 1.6 billion US dollars for milled rice. Hence, from 1989-98, the two varieties RD6 and RD15 yielded a total of 42.0 million tons paddy or 26.9 million tons milled rice worth 16.9 billion US dollars [5].

Other Asian countries

Induced mutations have also been widely used in many other Asian countries for breeding new varieties and in turn contributed to food security. Detailed information for Pakistan [19] and Vietnam [20] can be found elsewhere in this book.

In the Republic of Korea, sesame (*Sesamum indicum*) yield has been increased more than twice (from 283 kg/ha to 720 kg/ha) due to development and release of 15 improved determinate type, high oil content mutant varieties having phytophthora blight resistance and good

cooking quality. These mutants occupied 55% of the national acreage during the last two decades in Korea [21].

In Bangladesh, mutation breeding has resulted in the release of more than 40 mutant varieties belonging to more than 12 crop species. The Bangladesh Institute of Nuclear Agriculture (BINA), Mymensingh, is the major center of mutation breeding, and has released 16 mutant varieties of pulses, 11 of oilseeds, seven of rice, and five of tomato. Rice mutant var. Binasail, Iratom-24, Binadhan-6, all planted in a cumulative area of 795,000 ha, and mungbean mutant variety Binamoog-5, cultivated in 15,000 ha as a summer crop, have contributed substantially towards food security in Bangladesh [Ali Azam, personal communication, April 2008].

In Myanmar, the rice mutant variety 'Shwewartun' was developed and released in 1975 after irradiation of 'IR5' seeds in 1970. The improvement in grain quality, seed yield, and early maturity of the mutant compared to its parent variety, led to its large-scale planting. Between 1989-1993, it covered annually more than 0.8 million ha - 17% of the 4.8 million ha area under rice in Myanmar [5].

During the past decade, Vietnam has become an icon for the success of mutation breeding. Though it used to import 2-3 million tons of food annually in the decade of 1970-1980, Vietnam exported 4.3 million tons of rice, becoming the world's second-largest exporter of rice. The wide use of high yielding crop varieties including dozens of mutant varieties contributed substantially to this transformation into food self-sufficiency. For example, the mutant rice variety VND-95-20, grown on more than 300,000 ha/year, has become the top variety in southern Vietnam, both as an export variety and in terms of growing area. More information about mutant varieties and their great importance for the food security in Vietnam today, can be found in another paper in this book [20].

EUROPE

Induced mutations have become an inherent component of many current plant varieties in Europe, particularly for barley and durum wheat. Mutation techniques are also widely used in the breeding of flowers and horticulture cultivars, although it is not the topic of this paper. A few examples are given here, while the situation in Sweden is available elsewhere in this book [22].

Czech Republic and Slovakia (former Czechoslovakia)

The Gamma-ray induced cultivar Diamant was officially released in Czechoslovakia in 1965. Diamant was 15cm shorter than the parent cultivar 'Valticky', and had an increased grain yield of around 12%. In 1972, 43% of 600,000 ha of spring barley in Czechoslovakia were planted under either Diamant or mutant cultivars derived from Diamant. Roughly estimated, the total increase in grain yield was about 1,486,000 tons. During the same year, the spring barley cultivars that had mutated Diamant's *denso* gene in their pedigree were grown all over Europe on an area of 2.86 million ha [23].

The high-yielding, short-height barley mutants Diamant and Golden Promise were a major impact on the brewing industry in Europe; they added billions of US dollars to the value of the brewing and malting industry. More than 150 cultivars of malting barley in Europe, North America, and Asia were derived from crosses involving Diamant [5].

Finland

Balder J, a high yielding barley mutant released in Finland, had higher yield, greater drought resistance, better sprouting resistance, and greater 1,000 kernel weight. Nearly 1 million kg of 'Balder J' seed were sold by Jokioinen Seed Center [24]. Oat stiff straw mutant cultivar Ryhti occupied up to 41% of the total area of oat in Finland during 1970-80. Another stiff straw oat mutant cultivar, Puhti, released in 1970, occupied 30% of the oat planting area in Finland. Many new varieties now grown are derived from crosses with these mutant varieties [25].

Germany

Trumpf, the best-known barley mutant cultivar obtained after crossing with cultivar Diamant occupied more than 70% of the barley planting area in Germany. The mutant had a yield increased by 15% and better disease resistance. Used extensively in crossbreeding, Trumpf became incorporated into many barley breeding programmes in a large number of countries [25].

Italy

Mutant cultivar Creso of durum wheat was grown in about one-third of the total area of durum wheat in Italy. During a period of 10 years, in Italy alone, an extra economic profit of 1.8 billion US dollars was obtained by growing this cultivar. Castelporziano and Castelfusano high-yielding durum wheat mutants had shorter culms and spike length, better resistance to lodging, but higher numbers of grain per spikelet. Planted in sizable areas, they contributed notably to the national economy of Italy. Both mutants were also used in extensive crossbreeding [5, 24].

NORTH AMERICA

In North America, the USA is one of the world pioneering countries in the exploitation of induced mutation for plant improvement and has had many extraordinary successes. Significant progress has also been reported from Canada, and more recently Mexico.

USA

Wheat: Stadler, a high-yielding wheat mutant released in Missouri, had early maturity, resistance to races of leaf rust and loose smut, as well as better lodging resistance. It was once grown on two million acres annually in the USA [24].

Barley: Luther, a barley mutant, had 20% increased yield, shorter straw, higher tillering, and better lodging resistance. About 120,000 acres were planted annually in three states of the USA - a gain of an estimated 1.1 million US dollars in one year. It was used extensively in cross-breeding and several mutants were released. Pennrad, a high yielding winter barley mutant was released in Pennsylvania, had winter hardiness, early ripening and better lodging resistance. It was grown on about 100,000 ha in the USA [24].

Beans: Sanilac, a high-yielding Navy pea bean mutant cultivar, developed after irradiation with X-rays and released in Michigan, was grown on more than 87,000 ha. Similarly, about 160,000 ha were planted with common bean cultivars Gratiot and Sea-way, developed likewise by cross-breeding with a Michelite mutant [5, 24].

Rice: The semi dwarf gene allele *sd1*, which was induced through Gamma-ray mutagenesis, has enabled the American version of the "Green Revolution" in rice. Details of the *sd1* allele and its contribution to the rice production in the USA (as well as in Egypt and Australia) are shown in this book [26].

Two grapefruit varieties, Star Ruby and Rio Red, both developed through thermal neutron mutagenesis [27], have become a widely grown variety during the past two decades. The fruits of both cultivars are sold under the trademark 'Rio Star'. 'Rio Star' grapefruit is currently grown on 75% of the grapefruit planting area in Texas. The development of the two radiation induced mutant cultivars is considered as the most significant breakthrough in grapefruit growing in Texas since the discovery of Ruby Red in 1929 [5].

Canada

Rapeseed-Canola (Double zero rapeseed): Canola is Canada's third most important grain export, after wheat and barley. Contribution of Canola cultivars to the Canadian economy has been outstanding. In 2000, Canada planted 5,564,000 ha under canola and earned 350.5 million US dollars. Mutant cultivars with low erucic acid and very low (more than 30µm/g) glucosinolates have been developed and released in Canada [5].

The strongest modification of oil composition with induced mutations has been the development and release of linseed cultivars of the 'linola' type in Australia and Canada. Zero is the low-linolenic acid genotype derived by EMS (ethyl methanesulphonate) mutagenesis of the Australian linseed cultivar Glenelg and recombination of two mutated genes [28].

Mexico

In Mexico, promotion of radio-induced mutation breeding started in 1974. Two new wheat varieties, 'Centaurus' and 'Bajío Plus,' were derived from 'Salamanca' seeds irradiated at 500Gy; they showed increased yield and tolerance to lodging. Two soybean varieties, 'Hector' and 'Esperanza,' were obtained by irradiation of seeds from variety 'Suaví 86' at 150Gy. These new varieties exhibit an increased yield and reduction in dehiscence and lodging, being tolerant to white fly. 'SalCer' is another new soybean variety obtained through irradiation of seeds from line ISAEGBM₂ at 200Gy. Its improved traits are higher yields and increased height to first pod [29].

LATIN AMERICA

Argentina

Colorado Irradiado, a groundnut mutant with high yield and fat content, induced by X-rays, occupied more than 80% of the groundnut area (280,000 ha) in Argentina in the 1970s [Prina, A.R., Personal communication, August 2008]. Puita INTA-CL, a rice mutant with high yield and herbicide resistance, released in 2005, has occupied more than 18% of the rice growing area (32,400 ha) in Argentina since then [Prina, A.R., Personal communication, August 2008]. Also planted in Brazil, Costa Rica, Paraguay and Bolivia, this mutant variety has contributed significantly to these Latin American countries' economies and their food security.

Cuba

Rice: Attempts to obtain a rice mutant variety with good agronomical characteristics and salinity tolerance have been successful in Cuba. The first mutant released from *in vitro* mutagenesis using proton radiations in Cuba is 'GINES,' which shows the best performance under saline conditions, and has been successfully introduced in rural areas of Pinar del Río and Havana provinces [30].

Tomato: The very first tomato mutant released in Cuba, 'Maybel,' has shown very high performance under drought conditions and has been introduced in rural areas of different provinces of Cuba [31].

Peru

Mutation breeding has been very successfully used in breeding barley, the fourth most important food crop in terms of area in Peru. Centenario, a barley mutant with high yield (37% over the parent cultivar), earliness (18 days), higher protein (10.3%), better test weight and resistance to yellow rust, was released in 2006, is replacing the traditional cultivars of the central highlands of Peru, and contributes significantly to the food security of the country [32].

Kiwicha (*Amaranthus caudatus*) is a native and ancient crop of the Andean Region. Centenario (MSA-011), a mutant with high yield, earliness (45 days), tolerance to salinity, wide adaptability, better grain color and size, as well as higher market price, was released in 2006 and has covered 40% of the total Peruvian land dedicated to kiwicha crops [32].

AUSTRALIA

Rice: Nine rice varieties - 'Amaroo' (1987), 'Bogan' (1987), 'Echua' (1989), 'Harra' (1991), 'Illabong' (1993), 'Jarrah' (1993), 'Langi' (1994), 'Millin' (1995), and 'Namaga' (1997) - have been introduced in Australia. Rice mutant variety Amaroo has covered 60-70% of the rice cultivation area of Australia, and on average yielded 8.9 t/ha grain with a potential of 13.3 t/ha [33].

Lupine: Spontaneous mutation has been discovered and utilized in domestication of narrow-leafed lupine (*Lupinus angustifolius L.*). As the result of the domestication, lupine has become a dominant grain legume crop in Western Australia. Facing the new challenge of developing herbicide-tolerant cultivars, chemical mutagenesis has been used to create new tolerance to herbicide. The two lupine mutants (Tanjil-AZ-33 and Tanjil-AZ-55) are highly tolerant, six times more tolerant to metribuzin herbicide than the original parental cultivar Tanjil. This mutant Tanjil-AZ-33 is the most tolerant germplasm in narrow-leafed lupine. Both mutants also maintain the high yield and resistance to the disease anthracnose as cv Tanjil. These facts indicate that the mutation process has created tolerance to metribuzin in Tanjil, but has not altered Tanjil's yield capacity and anthracnose resistance. Induced mutation proves to be an effective tool in lupine improvement [34].

AFRICA

Egypt

As a result of the introduction of the two semi-dwarf mutant varieties, 'Giza 176' (1989) and 'Sakha 101' (1997) in Egypt, the average yield of rice in Egypt increased to 8.9 t/ha, compared with 3.8 t/ha in the rest of the world. Of these two, 'Giza 176' became the leading variety, with a potential yield of 10 t/ha [35].

Sudan

Mutation breeding in Sudan was effectively started about 20 years ago and covered crops like cotton, sugarcane, sesame, banana, tomato, groundnuts, and cereals. A banana mutant cultivar (Albeely) was released in the year 2003. Albeely excelled the yield of the existing cultivars by 40% and has better crop stand and fruit quality. Albeely is becoming popular and is widely preferred by farmers. A drought tolerant groundnut mutant (Barberton-B-30-3) and a number of promising mutants resistant to tomato yellow leaf curl virus (TYLCV) are being evaluated in multi-location trials, in preparation for their commercial release. Cotton germplasm has been enriched with a number of useful mutants carrying resistance for bacterial blight and fusarium wilt disease, in addition to mutants for weak fiber attachments, high ginning out turn, and lint percentage. These mutants are being used in the breeding programme, and promising lines are under field evaluation for release [36].

Ghana

Over two decades of application of induced mutation techniques toward crop improvement in Ghana have led to the production of improved mutant varieties in two crops. In cassava (*Manihot esculenta* Crantz), irradiation of stem cuttings using gamma irradiation resulted in the production of "Tek bankye," a mutant variety with high dry matter content (40%) and good poundability from the parental line, which was a segregant of a hybrid between the Nigerian landrace Isunikaniyan (ISU) and the breeder's line TMS4(2)1425, both from IITA, Nigeria. Similarly, irradiation of vegetative buds of 'Amelonado' (P30), 'Trinitario' (K.5), and 'Upper Amazon' (T85/799) cocoa varieties resulted in the production of a mutant variety resistant to the Cocoa Swollen Shoot Virus (CSSV). Multi-location on-farm trials of the mutant line indicate significant increases in yield for farmers, without symptoms of the disease [37].

Perspectives

World food security deteriorated very sharply in the 1960's when developing countries like India, Pakistan, and Indonesia were desperately short of food grains. Fortunately, agricultural scientists responded with a new production technology, which has popularly been described as "Green Revolution Technology." This helped to avoid large-scale starvation for around 40 years. However, the food security problem has again seen a major deterioration in the last few years; food prices are rising sharply and once again the poor people of the world are threatened

with serious malnutrition. The underlining causes that drove to food security deterioration, i.e. rising fuel and fertilizer prices, climate change related erratic rain falls, sudden and severe drought conditions, excessive floods, divert of food grains into bio-fuel production, will remain for the years to come. Food security will even get worse since population is still growing while no significant expansion of arable lands is foreseen. FAO estimates that world food production should increase by more than 75% in the next 30 years to feed about eight billion people by 2025 [38]. Therefore, a new "Green Revolution" is desperately needed to solve the food security issue in the years to come.

The massive advent of plant molecular biology is anticipated to provide a sound solution to further increase food production by both increasing yield potential and stability. In this regard, induced mutagenesis is gaining importance in plant molecular biology as a tool to identify and isolate genes, and to study their structure and function. Several papers in this book report the progress being made in this area. Recently mutation techniques have also been integrated with other molecular technologies, such as molecular marker techniques or high throughput mutation screening techniques; mutation techniques are becoming more powerful and effective in breeding crop varieties. Mutation breeding is entering into a new era: molecular mutation breeding. Therefore, induced mutations will continue to play a significant role for improving world food security in the coming years and decades.

BIBLIOGRAPHY

1. Muller, H.J. Artificial transmutation of the gene. *Science* **66**, 84-87 (1927).
2. Stadler, L.J. Mutations in barley induced by X-rays and radium. *Science* **68**, 186-187 (1928).
3. World Bank. Poverty and Hunger: Issues and Options for Food Security in Developing Countries. Washington D.C. (1986).
4. FAO. Rome Declaration on World Food Security. Rome, Italy (1996)
5. Ahloowalia, B.S., Maluszynski, M., Nichterlein, K. Global Impact of mutation-derived varieties. *Euphytica* **135**, 187-204 (2004).
6. FAO/IAEA Mutant Variety Database. (<http://mvgs.iaea.org>)
7. Shu, Q., Wu D., Xia, Y. The most widely cultivated rice variety 'Zhefu 802' in China and its genealogy. *MBNL* **43**, 3-5 (1997).
8. Wang, H.C., Qiu, S.M., Zheng, J.S., Jiang, L.R., Huang, H.Z., Huang, Y.M. Generation of new rice cultivars from mature pollens treated with gamma radiation. Abstract p.89. In: Book of Abstracts, FAO/IAEA International Symposium on Induced Mutations in Plants. 12-15 Aug., 2008, Vienna, Austria.
9. Zhu, B.G. Soybean varieties bred with induced mutation and their application in China. Abstract p.7. In: Book of Abstracts, FAO/IAEA International Symposium on Induced Mutations in Plants. 12-15 Aug., 2008, Vienna, Austria.
10. Qui, Q., Li, Z., Shen, F., Wang, Ch., Miao, H. Peanut breeding through mutation techniques in China. *MMBNL* **43**, 6-7 (1997).
11. Kharkwal, M.C., Pandey, R.N., Pawar, S.E. Mutation Breeding for Crop Improvement. p. 601-645. In: Jain, H.K. and Kharkwal, M.C. (ed.) Plant Breeding – Mendelian to Molecular Approaches. Narosa Publishing House, New Delhi, 2004.
12. Chakrabarti, S.N. Mutation breeding in India with particular reference to PNR rice varieties. *J. Nuclear Agric. Biol.* **24**, 73-82 (1995).
13. Kharkwal, M.C., Jain, H.K., Sharma, B. Induced Mutations for Improvement of Chickpea, Lentil, Pea and Cowpea. p.89-109. In: Proc. FAO / IAEA workshop on Improvement of Grain Legume Production using Induced Mutations. 1-5 July, 1986, Pullman, Washington (USA), IAEA, 1988, Vienna, Austria.
14. Kharkwal, M.C., Nagar, J.P., Kala, Y.K. BGM 547 - A high yielding chickpea (*Cicer arietinum L.*) mutant variety for late sown conditions of North Western Plains Zone of India. *Indian J. Genet.* **65**, 229-230 (2005).

15. Kharkwal, M.C., Gopalakrishna, T., Pawar, S.E., Haq, M. Ahsanul. Mutation Breeding for Improvement of Food Legumes. p.194-221. In: M.C. Kharkwal (ed.) Food Legumes for Nutritional Security and Sustainable Agriculture, Vol. 1. Proc. Fourth International Food Legumes Research Conference (IFLRC-IV), Oct. 18-22, 2008, New Delhi, India. Indian Society of Genetics and Plant Breeding, New Delhi, India (2008).
16. D'Souza, S.F. Mutation breeding in oilseeds and grain legumes in India: accomplishments and socio-economic impact. Abstract p.6. In: Book of Abstracts, FAO/IAEA International Symposium on Induced Mutations in Plants. 12-15 Aug., 2008, Vienna, Austria.
17. Nakagawa, Hitoshi. Induced mutations in plant breeding and biological researches in Japan. Abstract p.5. In: Book of Abstracts, FAO/IAEA International Symposium on Induced Mutations in Plants. 12-15 Aug., 2008, Vienna, Austria.
18. Anonymous, 1996. Bureau of Economic and Agricultural Statistics, Bangkok, Thailand.
19. Haq, M.A. Development of mutant varieties of crop plants at NIAB and the impact on agricultural production in Pakistan. Abstract p. 8. In: Book of Abstracts, FAO/IAEA International Symposium on Induced Mutations in Plants. 12-15 Aug., 2008, Vienna, Austria.
20. Mai, Q. V., Do K.T., Do, T.B., Do, H.A., Do, H.H. Current status and research directions of induced mutation application to seed crops improvement in Vietnam. Abstract p.144. In: Book of Abstracts, FAO/IAEA International Symposium on Induced Mutations in Plants. 12-15 Aug., 2008, Vienna, Austria.
21. Kang, C.W., Shim, K.B., Hwang, C.D., Pae, S.B. Improvement of sesame crop through induced mutations in Korea. Abstract p.142. In: Book of Abstracts, FAO/IAEA International Symposium on Induced Mutations in Plants. 12-15 Aug., 2008, Vienna, Austria.
22. Lundqvist, Udda. Eighty years of Scandinavian barley mutation genetics and breeding. Abstract p.4. In: Book of Abstracts, FAO/IAEA International Symposium on Induced Mutations in Plants. 12-15 Aug., 2008, Vienna, Austria.
23. Bouma, J., Ohnoutka Z. Importance and application of the mutant 'Diamant' in spring barley breeding. In: Plant Mutation Breeding for Crop Improvement. Vol.1. IAEA, Vienna, 127-133 (1991).
24. Anonymous, 1977. Manual on Mutation Breeding (Second Edition), Technical Reports Series, No. 119. Joint FAO/IAEA Division of Atomic Energy in Food and Agriculture, International Atomic Energy Agency, Vienna, Austria. p. 288.
25. Van Harten, A.M. Mutation Breeding: Theory and Practical Applications. Cambridge University Press, 1998.
26. Rutger, J.N. The induced *SDI* mutant and other useful mutant genes in modern rice varieties. Abstract p.5. In: Book of Abstracts, FAO/IAEA International Symposium on Induced Mutations in Plants. 12-15 Aug., 2008, Vienna, Austria.
27. Hensz, R.A. Mutation breeding of grapefruit (*Citrus paradist* Macf.). In: Plant Mutation Breeding for Crop Improvement. Vol.1. SM-311, IAEA, Vienna, 533-536 (1991).
28. Green, A.G., Dribnenki, J.C.P. Breeding and development of Linola™ (low linolenic flax). In: FAO-Proc. 3rd intern. Rax Breeding Research Group, France. FAO, Rome, 145-150 (1996).
29. Torres, E. De La Cruz. The role of mutation breeding on plant improvement in Mexico. Abstract p.9. In: Book of Abstracts, FAO/IAEA International Symposium on Induced Mutations in Plants. 12-15 Aug., 2008, Vienna, Austria.
30. González, M.C., Pérez, N., Cristo, E., Mayra Ramos. Salinity tolerant mutant obtained from protons radiations. Abstract p.56. In: Book of Abstracts, FAO/IAEA International Symposium on Induced Mutations in Plants. 12-15 Aug., 2008, Vienna, Austria.
31. González, M.C., Mukandama, J.P., Manssor Mohamed Ali, Delfina Trujillo, Iralis Ferradaz, Fuentes, J.L., Sonia Altane, Arais Fernández, Belkis Peteira. Development of drought tolerant tomato varieties through induced mutations in Cuba. Abstract p.56. In: Book of Abstracts, FAO/IAEA International Symposium on Induced Mutations in Plants. 12-15 Aug., 2008, Vienna, Austria.
32. Pando, Luz Gómez., Ana Eguluz, Jorge Jimenez, Jose Falconí. Barley (*Hordeum vulgare*) and kiwicha (*Amaranthus caudatus*) improvement by mutation induction in Peru. Abstract p.141. In: Book of Abstracts, FAO/IAEA International Symposium on Induced Mutations in Plants. 12-15 Aug., 2008, Vienna, Austria.
33. Clampett, W.S., Williams, R.L., Lacy, J.M. Major achievements in closing yield gap of rice between research and farmers in Australia. In: Yield Gap and Productivity Decline in Rice Production. International Rice Commission, FAO, Rome, 411-428 (2001).
34. Si, P., Buirchell, B., Sweetingham, M. Induced mutation in narrow-leafed lupin improvement: An example of herbicide tolerance. Abstract p.14. In: Book of Abstracts, FAO/IAEA International Symposium on Induced Mutations in Plants. 12-15 Aug., 2008, Vienna, Austria.
35. Badawi, A.T. Yield gap and productivity decline in rice production in Egypt. In: Yield Gap and Productivity Decline in Rice Production, International Rice Commission, FAO, Rome, 429-441 (2001).
36. Ali, A.M. Overview of mutation breeding in Sudan. Abstract p.8. In: Book of Abstracts, FAO/IAEA International Symposium on Induced Mutations in Plants. 12-15 Aug., 2008, Vienna, Austria.
37. Danso, K.E., Safo-Katanka, O., Adu-Ampomah, Y., Oduro, V., Amoatey, H.M., Asare, O.K., Ofori Ayeh, E., Amenorpe, G., Amiteye, S., Lokko, Y. Application of induced mutation techniques in Ghana: Impact, challenges and the future. Abstract p.108. In: Book of Abstracts, FAO/IAEA International Symposium on Induced Mutations in Plants. 12-15 Aug., 2008, Vienna, Austria.
38. Anonymous. Food security and agricultural production. p.5-24. In: Plant Nutrition for Food Security – A guide for integrated nutrient management. FAO Bull. No. 16, 2006, Rome.

Eighty Years of Scandinavian Barley Mutation Genetics and Breeding

U Lundqvist

Abstract

In 1928, the Swedish geneticists H. Nilsson-Ehle and Å. Gustafsson started on their suggestion experiments with induced mutations using a diploid barley species. The experiments started with X-rays and UV-irradiations, soon the first chlorophyll mutations were obtained followed by the first 'vital' mutations 'Erectoides.' Several other valuable mutants were considered: high-yielding, early maturity, lodging resistance and with changed ecological adaptation. Soon the X-ray experiments expanded with different pre- and after-treatments, also using other types of irradiation, such as neutrons, positrons etc., and finally with chemical mutagens, starting with mustard gas and concluding with the inorganic sodium azide. The research brought a wealth of observations of general biological importance, high increased mutation frequencies, differences in the mutation spectrum and to direct mutagenesis for specific genes. This Scandinavian mutation research was non-commercial even if some mutants have become of some agronomic value. The peak of its activities was during the 1950s, 1960s and 1970s. Barley has been the main experimental material, but also other species were included in the programme. Over the years a rather large collection of morphological and physiological mutations (10,000 different mutant genes) with a broad variation were collected and several characters have been analyzed in more detail genetically and with regard to mutagen specificity. Most effort has been made on the *Early maturity* mutants, the *Six-row (hexastichon)* and *Intermedium* mutant group, the *Surface wax coating: Eceriferum (Waxless)* mutants, *Dense spike* mutants and others.

The first mutation experiments

Swedish research on induced mutations started in a small scale at Svalöf 80 years ago, initiated by the eminent Swedish geneticists H. Nilsson-Ehle and Å. Gustafsson. Already in 1927, the North American geneticist and later Nobel laureate, H.J. Muller, using successful experiments could show that ionizing radiation could increase the mutation frequency in the fruit fly *Drosophila* [1, 2]. He drew the conclusion that induced mutations were similar to spontaneous mutations forming the basis for natural selection and evolution. Soon, in 1930, the equally famous American geneticist and plant breeder, L.J. Stadler [3], published data on induced mutations in several species of cultivated plants which he interpreted with much pessimism. In his opinion, no practical progress could be expected from artificial gene changes. But Nilsson-Ehle and Gustafsson did not share this pessimism and on Gustafsson's suggestion experiments were initiated with induced mutations in plant material.

The first treatments with X-rays and ultraviolet irradiation were commenced in barley, using the Svalöf cultivar 'Gull.' Instead of measuring exact dosages of radiation, different durations of radiations were applied. Also different types of pre-treatments were tested since it was known from Stadler's investigations that the mutation frequency increases if the seeds are soaked in water before irradiation. The first chromosome

aberrations were observed, mainly chromosome fragmentations, fusions and translocations [4]. The first genotypical changes in the seedlings, chlorophyll mutations, most of them sublethal, occurred. Three distinct main categories were established: *albina* seedlings, *viridis* seedlings, a very heterogeneous group, and rare mutations (*xantha*, two-coloured, striped and zoned). These chlorophyll mutations were a useful material for laboratory studies and were the first indications of how successful the treatment was. The mutation frequency was calculated according to the "spike progeny method" introduced by Gustafsson, and served as the standard method for measuring the induced mutagenic effects [5, 6].

Very soon, in the mid-1930s, the first viable mutations appeared and already at that time it was possible to distinguish two sub-groups: *Morphological* and *Physiological* mutations. The most common group of viable mutations at that time consisted of the so-called *erectoides* mutants that are characterized by typical compact or dense spikes in contrast to the *nutans* spike of most barley cultivars. In the following years many of the mutants produced were considered extremely valuable for future theoretical genetic studies and for breeding. Several of them are worth mentioning: high-yielding, early maturity, tillering capacity, straw-stiffness, seed-size, seed-color, changed spike formation and others [7, 8].

The Swedish group for theoretical and applied mutation research

The results from these early experiments looked so promising, even for plant breeding, that in 1940, the Swedish Seed Association at Svalöf started to support this research with funding from the Swedish milling industry. This rendered it possible to extend the experiments considerably. In addition, other species such as wheat, oats, flax, peas, faba beans and oil crops were included in the programme, and it became possible to integrate theoretical and practical results. In 1948, the Wallenberg Foundation incorporated mutation activities into its research programme, and a group of specialists were gathered to carry on the research work on a wider front. Finally, in 1953, at the instigation of the Swedish Government the 'Group for Theoretical and Applied Mutation Research' was established, with the aim of studying basic research problems in order to influence and improve the methods for breeding of cultivated plants. The Agricultural Research Council had provided funding for most of the Mutation Group's scientific activities approved by the Swedish Parliament. Its peaks of activities were during the 1950s, 1960s and 1970s. Barley was used as main model crop since it is a diploid self-fertilizing species, easy to handle, gives a sufficiently large progeny from a single plant and outcrosses only rarely [9, 10].

Applying different mutagenic treatments

X-irradiation on dry seeds was used as a standard method for studying the mutation process, but soon other types of irradiation such as γ -rays (acute and chronic), neutrons (fast and thermal), electrons, protons, α -rays from radon, β -rays from Phosphorus 32 and Sulphur 35 were included in the experiments. The application of pre-treatments with different soaking times of the seeds, both before and after irradiation

Nordic Genetic Resource Center, SE-230 53 Alnarp, Sweden.

E-mail: udda@nordgen.org

was studied. Not only the water content of the seeds was an important trait in relation to radiation sensitivity, but also different environmental conditions [11, 12]. The two irradiation types, sparsely versus densely ionizing radiation, were compared in the following properties: (1) the number of chromosome disturbances in the germinating seeds, (2) field germination, (3) number of mature harvested plants, (4) the mutation rate determined from the number of various chlorophyll-deficient mutants, and (5) different types of vital mutants determined on field material in the second generation. When comparing the two irradiation types it can be summarized as follows: The injurious action of neutrons differs from that of X-rays in several respects. The seeds are 20-30 times more sensitive in neutrons than to X-rays and germinating seeds are two to three times more sensitive to neutrons than dormant seeds. Neutrons are approximately 10 times as effective as X-rays in producing chromosome disturbances and about 50-100 times more effective in increasing the mutation rate in the second generation. Neutrons produce relatively more chlorophyll mutations than X-rays. Observations also showed that while X-irradiated seeds die at a very early stage of development, the neutron-treated seeds which received a lethal dose often start germination, not dying until cell divisions become of critical importance for their further growth [13, 14].

Already in the mid-1940s chemical mutagenesis started to be included in experiments together with irradiation. The idea was to influence not only the mutation rate but also the types of mutations. The real work on chemical mutagenesis in crop plants began with the effects of mustard gas followed by many different compounds such as various alkylating and oxidizing agents, epoxides and epimines, purines, organic sulphates and sulphonates, nitroso compounds, purine and acridine derivatives and many others [15-23]. Finally, in the mid-1970s, the first experiments were started with the inorganic chemical mutagen 'Sodium azide' that in Swedish experiments was mostly used for isolation of viable mutants for practical agronomical purposes [10, 24, 25]. For chemical mutagens the mutation frequency increased rapidly up to 80%; they were 20 times more effective than irradiation. Significant differences between the actions of ionizing radiation and chemical mutagens were demonstrated. In this respect, neutrons and sodium azide form two extremes: neutrons induce a relatively large number of chromosome and chromatid changes, whereas sodium azide primarily causes gene mutations at the nucleotide level. Differences in the mutation spectrum were noticed especially with regard to chlorophyll mutants as they were studied most intensively. Neutrons induce a higher rate of albina seedlings than X-rays and chemical mutagens. The chemical mutagens are superior in inducing the large heterogeneous group of viridis seedlings. Also in some morphological mutation groups and mutants useful for plant breeding it was possible to observe differences in the mutation spectrum. The aim was to control the direction of mutagenesis [10, 26].

The Swedish mutation research was non-commercial, despite that some mutants have been used in practice – directly or after recombination breeding [27]. The mutation programme brought a wealth of observations of general biological importance: chronology of chromosome reproduction, sensitivity of different mitotic stages, the importance of heterochromatin, mutations in polyploids, the variation of irradiation sensitivity in different species and competition between various elements in plant tissues.

The Swedish collection of barley mutants

Genetic diversity is an important feature in plant breeding and the breeder can use the artificially induced mutants for further improvement of his cultivars. A methodical work will sooner or later lead to positive results.

Over the years a large collection of morphological and physiological mutations (10,000 different mutant alleles) with a broad variation range have been brought together and have been genetically and agronomi-

cally studied. They consist of 10 main categories with 116 different subtypes (Table 1). So far, about half of these mutants have been analyzed genetically in more or less detail, but they form only a minor part of the range of mutant types. This collection forms an outstanding material for investigations within radiobiology, genecology, gene physiology, ultrastructural research and plant biochemistry, and physiology. It is a major source for future gene mapping and is valuable for molecular genetical analyses of cloned mutant genes. This Swedish collection is unique since all the alleles of the investigated genes are conserved at the Nordic Genetic Resource Center (former Nordic Gene Bank) and available for research and breeding. The mutant groups shown in the table below were studied in detail genetically and with regard to mutagen specificity. These studies have increased our knowledge of the mutation process and the genetic architecture of the different characters. In this presentation a few of these groups are presented in more detail (Table 2) [10, 28-31].

Table 1. Survey of the main mutant categories

1.	Changes in spike and spikelets
2.	Changes in culm length and culm composition
3.	Changes in growth type
4.	Changed kernel development and formation
5.	Physiological mutants
6.	Awn changes
7.	Changes in leaf blades
8.	Changed pigmentation
9.	Different chlorophyll development
10.	Resistance to powdery mildew

Table 2. Survey of the genetically investigated Scandinavian mutant groups

Mutant group	Number of alleles	Number of loci
Praematurum (Early maturity)	195	9
Erectoides	205	26
Breviaristatum (Short awns)	184	19
Eceriferum (Waxless, Glossy)	1580	79
Hexastichon (Six rowed spike)	65	1
Intermedium	80	10
Lemmlike glumes (Macrolepis)	40	1
Third outer glume (Bracteatum)	10	3
Calcaroides	21	5
Anthocyanin mutants	766	31
Liguleless (Auricleless and Exligulum)	24	2
Albino lemma (Eburatum)	5	1
Orange lemma (Robiginosum)	7	1
Mildew resistance	77	several
Chlorophyll synthesis and chloroplast development	357	105

Praematurum (early maturity) mutants

The demand for early cultivars has increased why earliness has become an important goal for Swedish plant breeding. Already in the 1940s, it was found that maturity in barley could easily be changed by X-rays, in either direction of both increased earliness and increased lateness. The time of heading was chosen as a safe character for the selection of induced early mutants, but early heading and early ripening are characters where environmental influences, especially climatic conditions may hamper a safe classification [32].

Over the years, about 1,250 different early maturity mutants have been isolated and studied after various mutagenic treatments. The mutants can be grouped into three categories according to their heading and maturity time with a variation between one and 10 days. Long term studies made it possible to establish nine *mat* loci among 195 localized mutants (Table 3) [10].

Table 3. Distribution of the early maturity mutants to the 9 *mat* loci

Locus	<i>mat-a</i>	<i>mat-b</i>	<i>mat-c</i>	<i>mat-d</i>	<i>mat-e</i>	<i>mat-f</i>	<i>mat-g</i>	<i>mat-h</i>	<i>mat-i</i>	Total
Mutants	85	49	31	2	9	7	4	2	6	195

The different loci in general show quite distinct phenotypic characters. The mutations selected for earliness also change other properties of agricultural value. Significantly shorter straw with lower internode number is found in the extreme early mutant loci, *mat-a*, *mat-b* and *mat-c*. Mutants of locus *mat-a* are generally more resistant to lodging than mutants in locus *mat-b*. Among these loci, *Praematurum* (*mat-a.8*) mutant, a drastic early mutant, heads 8 to 10 days earlier than its mother cultivar 'Bonus.' It was approved and released as a commercial Swedish cultivar under the name of 'Mari' in 1960, and was intended to replace early Swedish six-row cultivars. It was widely grown, as far north as Iceland and it was included in the breeding programme at Cymmit, Mexico [33]. Not until the mid-1960's it was found that *mat-a.8* had a special property that distinguished it from the 'Bonus' parent, namely, a profound change in the photo- and thermoperiod reaction, making it heading and seed fertile also at eight hours of daylight (short-day tolerant). During the 1960's, large phytotron experiments were carried out in Stockholm under different photoperiod conditions to compare different mutants and cultivars [34-36]. Later, when labour costs got too expensive, a darkening arrangement, using a special plastic tissue, was used in ordinary glasshouses with natural light lasting for eight hours. This type of arrangement was used for many years for identifying short day neutral mutants. It was possible to distinguish three genotype categories under the extreme short day conditions of eight hours of light: (1) genotypes with complete and early heading and good seed set; (2) genotypes with incomplete and late heading and seed set; and (3) genotypes that never headed remaining in a purely vegetative often luxurious stage. The mutants in *mat-c* and *mat-e* loci, are characterized by delayed heading and thus, a less pronounced short-day neutrality. The mutants in all other *mat* loci are long-day adapted like the parent cultivars [37]. Concerning the mutagenic treatments, there is a concentration of short-day adapted mutants under sulfonate treatments whereas the long-day adapted cases seem to accumulate when ethylene imine is applied. Other observations indicate that sodium azide is less efficient in producing day-length neutral mutants.

Six-row (*hexastichon*) and *intermedium* mutants

Genetic variability in barley has been of great importance and has long been studied in great detail. The Russian geneticist N.I. Vavilov felt it necessary to explore the total genetic diversity of crop plants throughout the world as well as diversity of related wild species. Barley is one of the oldest cultivated crops [38]. The number of rows of the spikelets is a key character in inferring the origin of barley. For at least 100 years, it has been discussed whether the progenitor of cultivated barley was six-rowed, two-rowed or both. Recently, the two-rowed progenitor hypothesis was supported by archeological specimens showing the existence of domesticated two-rowed remains that were older than six-rowed. The six-row (*hexastichon*) and *intermedium* mutants affect the development of the lateral spikelets with genetic interaction leading to synergistic enhancements. This research has given an insight into rather complex genetics of kernel rows in barley. Normal two-row barley carries, on opposite sides of the spike, central spikelets, with two reduced, sterile

lateral spikelets. The two-row barley is able to produce six-row barley in a single mutational step. These mutants have well developed lateral spikelets, fully fertile and with long awns. All the 45 isolated cases have been localized to only one locus, the *hex-v* (*vrs1*), located in the long arm of chromosome 2H [39]. Recently this sixrowed spike 1 (*vrs1*) gene was cloned by the Japanese research group (Komatsuda, *et al.*, 2007). It is indicated that it is a homeodomain-leucine zipper I-class homeobox gene. Expression of the *Vrs1* was strictly localized in the lateral spikelet primordial of immature spikes and suggests that the VRS1 protein suppresses development of lateral spikelets [40].

But two-row barley may also produce mutants with spike development intermediate between the two-row and the six-row states. These mutants have enlarged lateral spikelets with characteristic awn and kernel development, not only among mutants, but also depending on environmental conditions. A total of 126 such *intermedium* mutants have been isolated and 103 of them have been localized to 11 different *int*-gene loci and studied in more detail (Table 4) [41].

Table 4. Distribution of the *intermedium* mutants to the 11 *int* loci

Locus	-a	-b	-c	-d	-e	-f	-h	-i	-k	-l	-m
Number	33	3	23	21	14	1	4	1	1	1	1

The *hexastichon* (*hex-v*) mutants have six-rowed spikes with fully fertile, well developed, and long-awned lateral spikelets and thus resemble normal six-rowed barley. The *intermedium spike-d* (*Int-d*) mutants produce sterile or partially fertile lateral spikelets with variable awn length which appears intermediate to those of two-rowed barley. Allelism of these mutants showed that these two loci are closely linked to one another on chromosome 2HL and are more or less dominant. Komatsuda, *et al.* (2007) showed that the *Int-d* mutants are the same gene and morphological changes in the mutants can be attributed to changes in the *Vrs1* gene [40]. All other 10 *int* loci are recessive and showed independent inheritance. Both radiation types and most of the used chemical mutagens have been involved but no gene preference to the type of mutagen applied has been found [10].

Surface wax mutants: *Eceriferum* (waxless)

Presence of wax coating reduces evaporation of water from the plant and helps protect it against pathogens. Most surface wax mutants, the *eceriferum* and *glossy* loci affect the presence and type of epicuticular waxes on the leaf blades and sheaths, culms and spikes. When the wax coating is completely absent, various organs appear as a bright, glossy green color. Cooperation between Swedish and Danish researchers has made this mutant type probably the best known character complex of any cultivated plant. The mutants have been gene localized, their influence on yield studied, electron microscopy and biochemical analyses done, different loci mapped in chromosomes, and their reactions to various climates studied in the phytotron. Phenotypically three different organs of the barley plant were studied in regard to wax coating and composition and led to five phenotypic categories: spike and leaf sheath, spike and leaf sheath partially, spike, leaf blade, and spike, leaf sheath and leaf blade [42, 43]. A total of 1,580 such *eceriferum* mutants have been localized to 79 loci, 78 of them are recessive and one is dominant. Seven types of mutagenic treatments have been applied. It is obvious that different loci show markedly differing mutagen specific reactions. (1) There are particularly large mutagenic differences between chemicals and ionizing radiation, especially neutrons; (2) No significant differences among various kinds of organic chemicals can be established; (3) There are significant differences between organic chemicals and sodium azide; (4) The combined treatment (sulfonate + X- or γ -rays) does not differ from treatment with sulfonates alone, but differs from the treatment with exclusively X-rays. No difference to sodium azide can be demon-

strated; (5) Sodium azide differs strongly from X-rays and still more from neutrons; (6) There are clear differences between the two kinds of treatments with ionizing radiation; sparsely ionizing X-rays and densely ionizing neutrons having different effects on the target DNA molecule. In summary, the wealth of alleles distributed on a large number of *cer* loci has provided important insights into the mutation process. Obviously, different gene loci have different mutabilities. It is equally obvious that different loci show markedly differing mutagen specific reactions. These insights into the mutation process combined with knowledge of the localization of the different genes in the genome will add to our understanding of the mechanisms of mutagenesis and the organization of the eukaryotic genome [10, 44].

Dense spike mutants

The dense spike (*erectoides*) mutants were the first of the viable mutants induced by irradiation and the most commonly induced morphological changes. They are characterized by compact, dense spikes, implying that the spike rachis internodes are shorter than in the mother strain. They generally possess a very stiff and often short straw. The first uppermost internode of the culm is generally longer than in the mother cultivar and the basal ones being shorter. In all, about 1,270 such mutants have been isolated and studied intensively. Twenty-six gene loci could be established among 205 investigated mutants. Most of the loci have distinct phenotypic characteristics, one of them is dominant and all the others recessive. Several loci have been mapped spread over the seven barley chromosomes. Differences in the mutation spectrum could be noticed. Three of these loci could be identified as mutagen specific, where more than 80, 70% and 50%, respectively, of the alleles were induced by irradiation [45-48]. Most of these *erectoides* mutants are fully viable and promising from a practical point of view. The most outstanding of these mutants is *erectoides* 32 in locus *ert-k* that became released as a new cultivar 'Pallas' in 1958 [49].

Breeding aspects

Since work with artificial induction of mutations began, it was evident that mutation programmes should be regularly included in breeding programmes of crop plants. The application of mutation research in plant breeding was the most important stimulus. It was shown already in the 1950s and 1960s that the work at Svalöf can be used as an example how mutation breeding can be employed in a crop improvement programme. The main interest was focused on macromutations [50]. Both simple and rather complex characters such as straw-stiffness, earliness, higher yields, protein content and disease resistance are of interest. Not only new direct mutants, but also the indirect use of induced mutations was applied. In the latter case breeding work tried to change modifying systems by crossing mutants with various established cultivars and selecting the best recombinants homozygous for the mutations. In the Swedish programme, this use of macromutations in conventional cross-breeding programmes has proved to be more successful than recurrent mutagenic treatments [51].

Through the joint work with barley breeders and other scientists at Svalöf, a rather large number of mutant cultivars of two-row barley were registered as originals and commercially released. Two of these cultivars 'Pallas', a straw-stiff, lodging resistant and high-yielding *erectoides* mutant, and 'Mari', an extremely early, photo- and thermo-insensitive mutant, were produced directly by X-irradiation. All other cultivars derive from crosses and backcrosses, where the original breeding material was based on three primary high-yielding Swedish X-ray mutant cultivars: 'Pallas', 'Sv 44/3', both extreme lodging resistant, and 'Mari', extremely early. A series of cultivars obtained after crossing, (Table 5) were tested and found to be agriculturally suitable to various parts of Scandinavia and other parts of the world. The aim of this work was to demonstrate that original mutant materials can be used successfully in

recombined breeding programme in the hands of skilful breeders. It has set a positive trend, in fact, as positive and progressive as any other method of plant breeding [52]. Today, with modern technology, different methods ought to be used together, adding to the results of ordinary crossing and selection.

Useful mutations in barley include a wide range of economically important characters that influence morphological as well as the physiological and biochemical properties. The use of the mutation method is of importance in providing a detailed understanding of the genetic composition of the barley genome, especially if combined with detailed chromosomal and genetic analyses of linkage and biochemical studies of the DNA constitution and the amino acid composition.

Table 5. Survey of induced barley mutants and their derivatives, approved and released at Svalöf (after Gustafsson, 1986)

Parent strains	Derivates
	(1) Primary mutant varieties
'Gull'	44/3: extremely lodging resistant
'Bonus'	'Pallas' (ert-k.32) approved 1958
'Bonus'	'Mari' (mat-a.8) approved 1960
	(2) Varieties approved
Mutant crosses	
Herta x Pallas	'Hellas', approved 1967
Domen x Mari	'Kristina', approved 1969
Mari x Monte Cristo	'Mona', approved 1970
Birgitta x Mari	'Eva' and 'Salve', approved 1973 and 1974 respectively
44/3 x Birgitta	'Gunilla', approved 1970
(Birgitta x Mari) x Gunilla	'Pernilla', approved 1979
	(3) Varieties approved
Complex mutant crosses	
(Pallas x Triple awn lemma) x Pallas ^{bc}	'Visir', approved 1970
(Triple awn lemma x Pallas ^a) x Hellas	'Senat', approved 1974
Å 61657 x (Mari ^c x Triple awn lemma)	'Troja', but withdrawn 1981
Kristina x (Hellas ^a x (Pallas ^b x Rupee))	'Jenny', approved 1980
Lofa x (Å 6564 x (Mari ^{bc} x Multan))	'Lina', approved 1982

In conclusion, Å. Gustafsson's words from his last paper in 1986 [53] are summarized as follows: "Induced mutations in the hands of skilful breeders will be an important future tool in progressive plant breeding. This will be even more so when the chemistry of the gene has been studied more thoroughly. Genetic instruments of artificial selection will increase the power and capacity of the plant breeder. It seems rather strange that also today there is a certain negative attitude towards the use of mutations in plant breeding or in most experiments concerning the general evolutionary theory. Such negative ideas are often associated with the view that mutationists ignore the natural sources of genetic variability and oppose the breeding value of primitive biotype collections."

BIBLIOGRAPHY

1. Muller, H.J. Artificial Transmutation of the Gene. *Science* **66**, 84-87 (1927).
2. Muller, H.J. The Problem of Genetic Modification. Verh. V. int. Kongr. Vererbungsw. Z. ind. Abst. - Vererbungsl., Suppl. I, 234-260 (1928).
3. Stadler, L.J. Some Genetic Effects of X-Rays in Plants. *J. Hered.* **21**, 3-19 (1930).

4. Gustafsson, Å. The Different Stability of Chromosomes and the Nature of Mitosis. *Hereditas* **22**, 281-335 (1936).
5. Gustafsson, Å. Studies on the Genetic Basis of Chlorophyll Formation and the Mechanism of induced Mutating. *Hereditas* **24**, 33-93 (1938).
6. Gustafsson, Å. The Mutation System of the Chlorophyll Apparatus. Lunds Universitets Årsskrift, *N.F. Avd. 2. Bd.* **36**, 1-40 (1940).
7. Gustafsson, Å. Mutation Experiments in Barley. *Hereditas* **27**, 225-242 (1941).
8. Gustafsson, Å. Mutations in Agricultural Plants. *Hereditas* **33**, 1-100 (1947).
9. Gustafsson, Å. Swedish Mutation Work in Plants: Background and Present Organization. *Acta Agriculturae Scandinavica* **lv. 3**, 361-364 (1954).
10. Mutation Research in Barley. (http://www.Mps.Lu.Se/Fileadmin/Mps/People/Hansson/Udda_thesis) (1992).
11. Ehrenberg, L., Gustafsson, Å., Nybom, N. Effects of Ionizing Radiation in Barley. *Arkiv Botan. Ser.* **2.1**(17), 557-568 (1952).
12. Ehrenberg, L., Gustafsson, Å., Lundqvist, U., Nybom, N. Irradiation Effects, Seed Soaking and Oxygen Pressure in Barley. *Hereditas* **39**, 493-504 (1953).
13. Gustafsson, Å., Ehrenberg, L., Brunnberg, M. The Effects of Electrons, Positrons and α -Particles in Plant Development. *Hereditas* **36**, 419-444 (1950).
14. Ehrenberg, L., Gustafsson, Å., Levan, A., Von Wettstein, U. Radiophosphorus, Seedling Lethality and Chromosome Disturbances. *Hereditas* **35**, 469-489 (1949).
15. Gustafsson, Å., Mackey, J. The Genetical Effects of Mustard Substances and Neutrons. *Hereditas* **34**, 371-386 (1948).
16. Ehrenberg, L., Gustafsson, Å., Lundqvist, U. Chemically induced Mutation and Sterility in Barley. *Acta Chem. Scand.* **10**, 492-494 (1956).
17. Ehrenberg, L., Lundqvist, U., Osterman, S., Sparman, B. On the Mutagenic Action of Alkanesulfonic Esters in Barley. *Hereditas* **56**, 277-305 (1966).
18. Ehrenberg, L., Gustafsson, Å. On the Mutagenic Action of Ethylene Oxide and Diepoxybutane in Barley. *Hereditas* **43**, 595-602 (1957).
19. Ehrenberg, L., Lundqvist, U., Ström, G. The Mutagenic Action of Ethylene Imine in Barley. *Hereditas* **44**, 330-336 (1958).
20. Gustafsson, Å., Ehrenberg, L. Ethylene Imine: A New Tool For Plant Breeders. *The New Scientist*, 19 March (1959).
21. Ehrenberg, L., Lundqvist, U., Osterman, S., Sparman, B. On the Mutagenic Action of Alkanesulfonic Esters in Barley. *Hereditas* **56**, 277-305 (1966).
22. Ehrenberg, L., Gustafsson, Å., Lundqvist, U. The Mutagenic Effects of Ionizing Radiations and Reactive Ethylene Derivates in Barley. *Hereditas* **45**, 351-368 (1959).
23. Ehrenberg, L., Gichner, T. On the Mutagenic Action of N-Alkyl-N-Nitrosoamides in Barley. (Supplement Festschrift Hans Stubbe) *Biologisches Zentralblatt* **86**, 107-118 (1967).
24. Nilan, R.A., Kleinhofs, A., Sander, C. Azide Mutagenesis in Barley. Barley Genetics III. *Proc. Third int. Genetic Symp., Garching 1975*. (Ed. H. Gaul) Verlag Thieme, Munich, 113-122 (1976).
25. Nilan, R.A. Recent Advances in Barley Mutagenesis. Barley Genetics IV. *Proc. Fourth int. Genetic Symp., Edinburgh, 1981*. (Ed. R.N.H. Whitehouse). Edinburgh University Press, Edinburgh. 823-831 (1981).
26. Wettstein, D. Von, Gustafsson, Å., Ehrenberg, L. Mutationsforschung Und Züchtung. in: Arbeitsgemeinschaft Für Forschung Des Landes Nordrhein-Westfalen. *Köln Und Opladen* **73**, 7-50 (1959).
27. Gustafsson, Å., Lundqvist, U., Ekberg, I. Yield Reactions and Rates of Chromosome Rearrangements and Gene Mutations in Barley. *Hereditas* **56**, 200-206 (1966).
28. Ehrenberg, L., Gustafsson, Å., Lundqvist, U. Viable Mutants induced in Barley By Ionizing Radiations and Chemical Mutagens. *Hereditas* **47**, 243-282 (1961).
29. Lundqvist, U. Barley Mutants – Diversity and Genetics. In: Svalöf 1886-1986, Research and Results in Plant Breeding (Olsson, G., Ed.) Lts Förlag, Stockholm, 85-88 (1986).
30. Lundqvist, U. The Swedish Collection of Barley Mutants Held at the Nordic Genebank. *Barley Genetics Newsletter* **35**, 150-154 (2005).
31. The International Database For Barley Genes and Barley Genetics Stocks. www.untamo.net/bgs
32. Gustafsson, Å., Hagberg, A., Lundqvist, U. The Induction of Early Mutants in Bonus Barley. *Hereditas* **46**, 675-699 (1960).
33. Hagberg, A. Svalöfs Original Mari-Korn. "Aktuellt Från Svalöf", Allmänna Svenska Aktieförlaget, 13-16 (1961).
34. Dormling, I., Gustafsson, Å., Jung, H.R., Wettstein, D. Von. Phytotron cultivation of Svalöf's Bonus barley and its mutant Svalöf's Mari. *Hereditas* **56**, 221-237 (1966).
35. Dormling, I., Gustafsson, Å. Phytotron cultivation of early barley mutants. *theor. Appl. Genet.* **39**, 51-61 (1969).
36. Gustafsson, Å., Dormling, I., Lundqvist, U. Gene, genotype and barley climatology. *Biol. Zentbl.* **101**, 763-782 (1982).
37. Gustafsson, Å., Lundqvist, U. Controlled environment and short-day tolerance in barley mutants. induced Mutations in Cross Breeding (Proc. Panel Vienna, Vienna, 1975), Vienna, 45-53 (1976).
38. Bothmer, R. Von, Jacobsson, N., Baden, C., Jørgensen, R.B., Linde-Laursen, I. A geographical study of the genus *Hordeum*. Systematic and Ecogeographical Studies on Crop Gene pools 7. IBPGR, Rome, 127 (1991).
39. Gustafsson, Å., Lundqvist, U. Hexastichon and *intermedium* mutants in barley. *Hereditas* **92**, 229-236 (1980).
40. Komatsuda, T., Pourkheirandish, C., He, P., Azhaguvel, H., Kanamori, D., Stein, N., Graner, A., Wicker, T., Tagiri, A., Lundqvist, U., Fujimura, T., Matsuoka, M., Matsumoto, T., Yano, M. Six-rowed barley originated from a mutation in a homeodomain-leucine zipper I-class homeobox gene. *Proc. Nat. Acad. Sciences* **104**, 1424-1429 (2007).
41. Lundqvist, U., Lundqvist, A. Induced *intermedium* mutants in barley. Origin, morphology and inheritance. *Hereditas* **108**, 13-26 (1988).
42. Lundqvist, U., Wettstein, D. Von. Induction of *eceriferum* mutants in barley by ionizing radiations and chemical mutagens. *Hereditas* **48**, 342-362 (1962).
43. Lundqvist, U., Von Wettstein-Knowles, P., Wettstein, D. Von. Induction of *eceriferum* mutants in barley by ionizing radiation and chemical mutagens. II. *Hereditas* **59**, 473-504 (1968).
44. Lundqvist, U., Lundqvist, A. Mutagen specificity in barley for 1580 *eceriferum* mutants localized to 79 loci. *Hereditas* **108**, 1-12 (1988).
45. Hagberg, A., Nybom, N., Gustafsson, Å. Allelism of erectoides mutations in barley. *Hereditas* **38**, 510-512 (1952).
46. Hagberg, A., Gustafsson, Å., Ehrenberg, L. Sparsely contra densely ionizing radiations and the origin of *erectoid* mutations in barley. *Hereditas* **44**, 523-530 (1958).
47. Hagberg, A. Heterozygosity of *erectoides* mutants in barley. *Hereditas* **39**, 161-178 (1953).
48. Persson, G., Hagberg, A. induced variation in a quantitative character in barley. Morphology and cytogenetics of *Erectoides* mutants. *Hereditas* **61**, 115-178 (1968).
49. Fröjer, K., Borg, G., Gustafsson, Å. *Pallas* Barley, a variety produced by ionizing radiation: its significance for plant breeding and evolution. In: United Nations' Report 2nd Conference on the peaceful uses of atomic energy in Geneva, August 1958, p.15 (1958).
50. Gustafsson, Å. Productive mutations induced in barley by ionizing radiations and chemical mutagens. *Hereditas* **50**, 211-263 (1963).
51. Gustafsson, Å., Hagberg, A., Persson, G., Wiklund, K. Induced mutations and barley improvement. *Theor. Appl. Genet.* **41**, 239-248 (1971).
52. Gustafsson, Å. Positive Mutationen und ihre Verwendung in der Züchtung hochleistender Gerstensorten. Bericht über die Arbeitstagung 1969 der Arbeitsgemeinschaft der Saatzuchtleiter in Gumpenstein, November 1969, 63-88.
53. Gustafsson, Å. Mutation and gene recombination – principle tools in plant breeding. Svalöf 1886-1986, Research and Results in Plant Breeding (Olsson, G., Ed.) Lts förlag, Stockholm, 76-84 (1986).

The Induced *sd1* Mutant and Other Useful Mutant Genes in Modern Rice Varieties

J N Rutger

Abstract

Induced mutation was accelerated in the USA with the release in California in 1976 of Calrose 76, the nation's first semidwarf table rice variety. Success was due not only to induction of mutants but also to their evaluation and integration into cross-breeding programmes. Thus the evaluation of Calrose 76 showed that its *sd1* gene was allelic to *sd1* in the indica Green Revolution varieties DGWG, TN(1) and IR8, and that semidwarfism conferred a yield advantage of 14% over the 6mt/ha yield level of the tall japonicas. Immediate integration of the Calrose 76 source of semidwarfism into cross-breeding has resulted in 25 semidwarf varieties that trace their ancestral source of semidwarfism to Calrose 76: 13 in California, 10 in Australia, and 2 in Egypt. Calrose 76 ancestry also appears in the pedigrees of numerous additional California cultivars derived from crossing the Calrose 76 source with the IR8 source of semidwarfism. In the late 1990s 12 semidwarf mutants were induced in tall tropical japonica varieties at the Dale Bumpers National Rice Research Center in Arkansas. The semidwarfing gene in each of these 12 germplasms was found to be nonallelic to *sd1*. Although selected for productivity, none of the 12 consistently showed yield increases typical of *sd1* sources. The *sd1* source, whether from induced mutation or from the indica source, is truly associated with enhanced productivity. Other induced mutants were found for early flowering, low phytic acid, giant embryo, and marker genes such as gold leaf and extreme dwarfism. The early flowering mutants were recovered in temperate japonicas, in tropical japonicas, and most recently in indicas. The early flowering indica mutants are quite interesting since they provide high-yielding or blast disease-resistant indica germplasm which will mature in the USA.

Introduction

The author's experiences with induced mutation for rice improvement have had two parts: First, from 1970-1988 as a Research Geneticist with the U. S. Department of Agriculture, Agricultural Research Service (USDA-ARS) at Davis, California, working on temperate japonica rice; and second, from 1993-2005 as Director of the USDA-ARS Dale Bumpers National Rice Research Center (DB NRRC) at Stuttgart, Arkansas, working on tropical japonica and on indica rice. Following a final period as Chief Scientist at the DB NRRC the author retired in January 2007 and moved back to California. Throughout his career the author has concentrated on selecting agronomically useful mutants such as semidwarfism and early flowering, with occasional detours into male steriles and marker genes as genetic tools. Keys to the success of the work have been, first the induction of mutants in very good varietal backgrounds, second their evaluation both agronomically and genetically, and third, immediate integration into conventional cross-breeding programmes by rice breeding colleagues.

Retired Chief Scientist, Dale Bumpers National Rice Research Center, Stuttgart, Arkansas 72160 USA; 1989 Witham Drive, Woodland, California 95776 USA.

E-mail: neil.rutger@sbcglobal.net



Figure 1 The induced mutant Calrose 76, released in 1976, was the first semidwarf table rice variety in the USA. It was about 25% shorter than its parent and the closely related tall check variety CS-M3 [7]

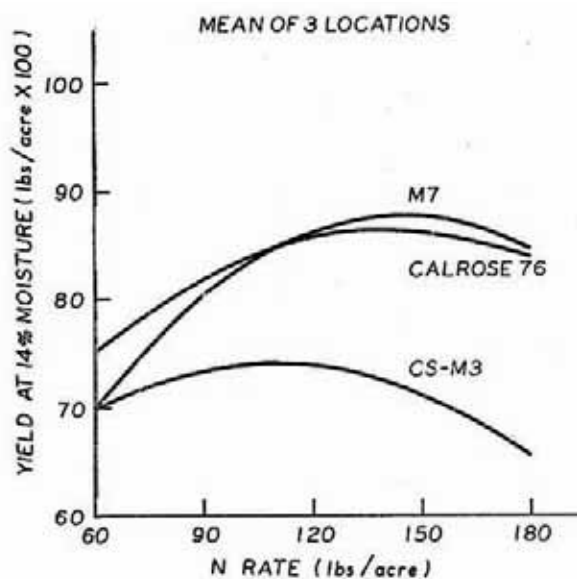

Figure 2 Averaged over nitrogen fertilizer rates from 60 to 180 lb/acre (67 to 202 kg/ha), the two semidwarf varieties Calrose 76 and M7 yielded 14% more grain and 13% less straw than the tall cultivar CS-M3 [2]

Temperate japonicas

Induced mutation work in the early 1970s resulted in the induction and direct release of Calrose 76, the first semidwarf table rice variety in the United States [1]. The work was a cooperative effort involving an IAEA-sponsored visiting scientist from Taiwan, Dr. Chao-hwa Hu, several

University of California Scientists, and the author. Following the induction of the semidwarf mutant, it was evaluated in yield trials where it was shown to be about 25% shorter than its parent and the closely related tall check variety CS-M3 (Fig. 1), and to produce 14% more grain and 13% less straw than the tall check (Fig. 2) [2]. Genetic evaluation showed that the semidwarfing gene in Calrose 76 was allelic to *sd1* from DGWG [3]. However, the greatest application of Calrose 76 was its integration into cross-breeding efforts. For example, the semidwarf, early maturing variety M-101 [4] was developed from the pedigree CS-M3/Calrose76//D31, where D31, another mutant from Calrose [5], contributed early maturity. The most popular Calrose 76 derivative semidwarf was M7, from the cross Calrose 76/CS-M3 [6]. Altogether, Calrose 76, usually through the derivative glabrous leaf variety M7, has served as the ancestral source of semidwarfism for numerous varieties: 13 in California [7] (Table 1), 2 in Egypt [18], and 10 in Australia (R. Reinke, Rice Breeder, Yanco Agricultural Institute, personal communication, December 21, 2005).

Table 1. California varieties for which Calrose 76 served as the ancestral source of semidwarfism

Variety	Year	Pedigree	Reference
Calrose 76	1976	Induced mutant of Calrose	[1]
M7	1978	Calrose 76/CS-M3	[6]
M-101	1979	CS-M3/Calrose 76//D31	[4]
M-301	1980	Calrose 76/CS-M3//M5	[8]
S-201	1980	Calrose 76/CS-M3//S6	[9]
M-302	1981	Calrose 76/CS-M3//M5	[10]
Calmochi-101	1985	Tatsumochi//M7/S6	[11]
S-101	1988	70-6526//R26/Toyohikari/3/M7/74-Y-89/SD7/73-221	[12]
M-103	1989	78-D-18347/M-302	[13]
S-301	1990	SD7/730221/M7P-1/3/M7P-5	[14]
S-102	1996	Calpearl/Calmochi-101//Calpearl	[15]
Calhikari-201	1999	Koshihikari/(Koshihikari/S-101)*2	[16]
Calamylo-201	2006	Induced low amylose mutant of Calhikari-201	[17]

Calrose 76 ancestry also appears in the pedigrees of many additional California varieties resulting from crosses between the Calrose 76 source and the indica sources IR8 or DGWG (K.S. McKenzie, Director of California Cooperative Rice Research Foundation (CCRRF), (personal communication, August 22, 2005). Molecular technology now makes it possible to determine exactly which parent contributed the semidwarf allele gene in such semidwarf x semidwarf crosses. For example, the most successful variety in California for the last two decades, M-202 [19], derived from crossing the Calrose 76 source with the IR8 source, was recently shown to carry *sd1* from IR8, while S-101, another variety resulting from crossing the two sources, carries *sd1* from Calrose 76 (T. H. Tai, Rice Geneticist, Davis, California, personal communication, October 17, 2006). Another recent report confirms that M-202 carries *sd1* from IR8 rather than from Calrose 76 [20].

A measure of how extensively the CCRRF rice breeders have used mutants in their programme can be gleaned from perusal of their 26 mutant or mutant-derived varieties in the mvgs.iaea.org database [21]. As well as using the ancestral Calrose 76 *sd1* source of semidwarfism in cross-breeding the CCRRF has made direct releases of four independent mutant varieties:

- Calmochi-201, a waxy endosperm mutant of the variety S6 [22].
- M-401, a semidwarf mutant of the premium grain variety Terso [23].
- M-203, an early maturity mutant of M-401 [24].
- Calamylo-201, a speciality low amylose (about 6%) mutant of Calhikari-201 [17]. Calamylo-201 thus has two mutant genes,

sd1 from its Calhikari-201 parent, and the newly induced gene for low amylose.

The CCRRF also has developed aromatic varieties through use of basmati semidwarf mutants [25]:

- A-201, includes a basmati semidwarf, PI457920, in its parentage [26]
- Calmati-201, includes another basmati semidwarf, PI457918, in its parentage [27]
- Calmati-202, another basmati semidwarf, with A-201 as a parent (K.S. McKenzie, Director of California Cooperative Rice Research Foundation, personal communication, June 1, 2008).

Tropical japonicas

Upon becoming Director of the DB NRRC in Arkansas in 1993, the author launched a programme to induce semidwarf mutants in Arkansas tall, tropical japonica, varieties, since at that time no semidwarf varieties had been released in Arkansas. Inheritance studies showed that each of the 12 mutants induced had a recessive gene for semidwarfism [28, 29, 30]. When crossed with a known source of the Calrose 76 semidwarfing gene, each of the new semidwarfs was found to be nonallelic to *sd1*. Intercrosses among the 12 sources were not done, so it not known how many separate genes were involved. Each semidwarf was selected to be competitive with its tall parent, but none consistently exceeded the yield of its parent, as had been the case with *sd1* in California. Although not useful for direct release as mutant varieties, the 12 new semidwarfs were released as improved germplasm to interested breeders and other scientists.

Other tropical japonica mutants induced during the Arkansas period included: the KBNT lpa 1-1 low phytic acid mutant, with a 45% reduction in phytic acid [31]; the LGRU *ef* early flowering mutant [32]; and two dominant and one recessive genetic male sterile mutants [33]. The low phytic acid mutant also was crossed to a related variety carrying the goldhull (*gh*) gene to produce goldhull low phytic acid germplasm (GLPA) that could be identified by its goldhull marker gene in the field, in the farm truck, and in the grain elevator [34].

Indicas

By the mid-1990s, it was well established that indica germplasm, if sufficiently early in maturity, significantly outyielded the tropical japonicas in the southern USA [35]. Therefore the author began crossing a very early, bold grain, variety from China, Zhe 733, with six improved indica germplasms from IRRI, resulting in the release of nine indica germplasms, indica-1 to indica-9, with yield and maturity similar to southern varieties and grain quality approaching USA long grain standards [36]. Grain quality of the IRRI parents was almost identical to USA long grains, but the IRRI parents were about a month too late in maturity for USA environments. Therefore a programme was initiated to induce early maturity in the IRRI indicas, resulting in the release of six early flowering germplasms, indica-10 to indica-15 [37, 38]. Typical of these was indica-12, which was 28 days earlier than its indica parent, making it almost as early as local tropical japonica varieties (Fig. 3). Another indica of interest was the famous blast resistant variety from Colombia, Oryzica llanos 5, which also was a month too late for Arkansas. Therefore, early maturity mutants were induced in this variety, resulting in the release of three improved germplasms, indica-16 to indica-18, which were 24 to 36 days earlier than the parent and retained its blast resistance [39].

Other indica mutants induced during the Arkansas years included: the Guichao 2 *eui* mutant [40], which is allelic to the temperate japonica *eui* mutant found in California some 24 years earlier [41]; four indica genetic stocks, for apoptosis, narrow leaf, extreme dwarf, and gold leaf [42]; and four more genetic stocks, including: the long grain giant embryo mutant GSOR 25; a population segregating for albinos, GSOR 26, for elementary school teaching demonstrations; and two double-dwarf mutants, GSOR 27 and 28, which are 15 to 20cm shorter than their respective single-dwarf parents [43].



Figure 3 The induced early flowering mutant *indica-12* (right) was 28 days earlier than its IRR1 parent (left), making it useful for the USA since the IRR1 parent is about a month too late when grown in the USA [7].

A japonica/indica mapping population of 353 F10/11 lines was produced by crossing the japonica KBNT *lpa 1-1* mutant with the indica variety Zhe 733 [44]. This material, designated the K/Z mapping population, has been placed in the GSOR [43] collection at the DB NRRC, where it has become an often-requested population by geneticists and other scientists.

While in Arkansas the author also participated in an IAEA programme on Multi-location yield trials of rice mutants in 6 countries in the Latin American region: Brazil, Colombia, Costa Rica, Cuba, Guatemala and Uruguay. In this programme eight mutant lines were identified as potentially suitable for cultivation in cooperating countries and were incorporated into national rice trials [45]. In addition, desirable mutated characteristics were found which could be transferred through crossing programmes: earliness, salinity tolerance, blast resistance, resistance to shattering, translucent grain, high milling yield, plant height, and high yield potential

Another achievement in Arkansas was the development of *aromatic se* germplasm as a semidwarf(s), early maturing (e) recombinant from the cross between a late maturing semidwarf mutant, DM 107-4, and the early maturing tall variety Kashmir Basmati [46]. Both of the parents were induced mutants of Basmati 370, developed by M. A. Awan in Pakistan [25]. Although *aromatic se* retains the aroma and cooking quality of the original basmati source, yield has been low relative to conventional Arkansas varieties [46]. Efforts to develop additional aromatic varieties through induction and inter-crossing of mutants are underway.

BIBLIOGRAPHY

- Rutger, J.N., Peterson, M.L., Hu, C.H. Registration of Calrose 76 rice. *Crop Sci.* **17**, 978 (1977).
- Brandon, D.M., Carnahan, H.L., Rutger, J.N., Tseng, S.T., Johnson, C.W., Williams, J.F., Wick, C.M., Canevari, W.M., Scardaci, S.C., Hill, J.E. California rice varieties: Description, performance and management. Special Pub. 3271, Division Of Agricultural Sciences, Univ. Of Calif., p. 39 (1981).
- Foster, K.W., Rutger, J.N. Inheritance of semidwarfism in rice *Oryza Sativa* L. *Genetics* **88**, 559-574 (1978).
- Rutger, J.N., Peterson, M.L., Carnahan, H.L., Brandon, D.M. Registration of 'M 101' rice. *Crop Sci.* **19**, 929 (1979).
- Mckenzie, K.S., Board, J.E., Foster, K.W., Rutger, J.N. Inheritance of heading date of an induced mutant for early maturity in rice (*Oryza sativa* L.). *Sabao J.* **10**, 96-102 (1978).
- Carnahan, H.L., Johnson, C.W., Tseng, S.T. Registration of M7 rice. *Crop Sci.* **18**, 356-357 (1978).
- Rutger, J.N. Thirty years of induction, evaluation, and integration of useful mutants in rice genetics and breeding. IAEA Mutation Breeding Reports, **1**(2), 4-13 (2006).
- Johnson, C.W., Carnahan, H.L., Tseng, S.T., Brandon, D.M., Registration of 'M-301' rice. *Crop Sci.* **20**, 551-552 (1980).
- Carnahan, H.L., Johnson, C.W., Tseng, S.T., Brandon, D.M. Registration of 'S-201' rice. *Crop Sci.* **20**, 551-552 (1980).
- Johnson, C.W., Carnahan, H.L., Tseng, S.T., Hill, J.E. Registration of 'M-302' rice. *Crop Sci.* **21**, 986 (1981).
- Carnahan, H.L., Johnson, C.W., Tseng, S.T., Hill, J.E. Registration of 'Calmochi-101' rice. *Crop Sci.* **26**, 197 (1986).
- Johnson, C.W., Carnahan, H.L., Tseng, S.T., Oster, J.J., Hill, J.E., Rutger, J.N., Brandon, D.M. Registration of 'S-101' rice. *Crop Sci.* **29**, 1090-1091 (1989).
- Johnson, C.W., Carnahan, H.L., Tseng, S.T., Mckenzie, K.S., Hill, J.E., Rutger, J.N., Brandon, D.M. Registration of 'M-103' rice. *Crop Sci.* **30**, 960-961 (1990).
- Johnson, C.W., Mckenzie, K.S., Tseng, S.T., Oster, J.J., Hill, J.E., Brandon, D.M., Carnahan, H.L. Registration of 'S-301' rice. *Crop Sci.* **31**, 1090-1091 (1991).
- Mckenzie, K.S., Johnson, C.W., Tseng, S.T., Oster, J.J., Hill, J.E., Brandon, D.M. Registration of 'S-102' rice. *Crop Sci.* **37**, 1018-1019 (1997).
- Mckenzie, K.S. Rice Cultivar Calhikari-201, U.S. Patent 6316705 (2001).
- Mckenzie, K.S., Johnson, C.W., Jodari, F., Oster, J.J., Hill, J.E., Mutters, R.G., Greer, C.A., Canavari, W.M., Takami, K. Registration of 'Calamylo-201' rice. *Crop Sci.* **46**, 2321-2322 (2006).
- Badawi, A.T. Sustainability of rice production in Egypt. In: Proc. International Symposium On Rice Germplasm Evaluation and Enhancement. *Arkansas Agric. Exp. Stn. Special Report* **195**, 43-51 (1999).
- Johnson, C.W., Carnahan, H.L., Tseng, S.T., Oster, J.J., Hill, J.E. Registration of 'M-202' rice. *Crop Sci.* **26**, 198 (1986).
- Asano, K., Takashi, T., Miura, K., Qian, Q., Kitano, H., Matsuoka, M., Ashikari, M. Genetic and molecular analysis and utility of *Sd1* alleles in rice breeding. *Breeding Science* **57**, 53-58 (2007).
- Joint FAO/IAEA Programme on Database of mutant variety and genetic stocks, mvgs.iaea.org.
- Carnahan, H.L., Johnson, C.W., Tseng, S.T., Brandon, D.M. Registration of 'Calmochi-201' rice. *Crop Sci.* **19**, 746 (1979).
- Carnahan, H.L., Johnson, C.W., Tseng, S.T., Brandon, D.M. Registration of 'M-401' rice. *Crop Sci.* **21**, 986-987 (1981).
- Carnahan, H.L., Johnson, C.W., Tseng, S.T., Oster, J.J., Hill, J.E., Brandon, D.M. Registration of 'M-203' rice. *Crop Sci.* **29**, 1089-1090 (1989).
- Awan, M.A. Development of early maturing and short statured varieties of rice through the use of induced mutations, Final Technical Report, PI-480 Project PK-ARS-117, Nuclear Institute for Agriculture and Biology, Faisalabad, Pakistan (1984).
- Tseng, S.T., Mckenzie, K.S., Johnson, C.W., Oster, J.J., Hill, J.E., Brandon, D.M. Registration of 'A-201' rice. *Crop Sci.* **37**, 1390-1391 (1997).
- Tseng, S.T., Mckenzie, K.S., Johnson, C.W., Oster, J.J., Hill, J.E., Brandon, D.M. Registration of 'Calmati-201' rice. *Crop Sci.* **41** (2001) 2005.
- Rutger, J.N., Moldenhauer, K.A.K., Gravois, K.A., Lee, F.N., Norman, R.J., McClung, A.M., Bryant, R.J. Registration of six *semidwarf* mutants of rice. *Crop Sci.* **44**, 364-366 (2004).
- Rutger, J.N., Moldenhauer, K.A.K., Gravois, K.A., Lee, F.N., Norman, R.J., Bryant, R.J. Registration of five induced *semidwarf* mutants of rice. *Crop Sci.* **44**, 1496-1497 (2004).
- Rutger, J.N., Bryant, R.J., Moldenhauer, K.A.K. Registration of induced semidwarf rice mutant DR1. *Crop Sci.* **46**, 2340 (2006).
- Rutger, J.N., Raboy, V., Moldenhauer, K.A.K., Bryant, R.J., Lee, F.N., Gibbons, J.W. Registration of KBNT *lpa 1-1* low phytic acid germplasm of rice. *Crop Sci.* **44** 363 (2004).
- Rutger, J.N., Moldenhauer, K.A.K., Gibbons, J.W., Anders, M.M., Bryant, R.J. Registration of LGRU of early flowering mutant of rice. *Crop Sci.* **44**, 1498 (2004).
- Zhu, X., Rutger, J.N. Inheritance of induced dominant and recessive genetic male-sterile mutants in rice (*Oryza sativa* L.). *Sabao J.* **31**, 17-22 (1999).
- Rutger, J.N., Bryant, R.J., Moldenhauer, K.A.K., Gibbons, J.W. Registration of goldhull low phytic acid (GLPA) germplasm of rice. *Crop Sci.* **44**, 1497-1498 (2004).

35. Eizenga, G.C., McClung, A.M., Rutger, J.N., Bastos, C.R., Tillman, B. Yield comparison of indica and U.S. cultivars grown in the southern United States and Brazil, pp 62-70, In: Rice Research Studies, Arkansas Experiment Station Research Series 540, R.J. Norman, J.-F. Meullenet and K. A. K. Moldenhauer, eds. (2006).
36. Rutger, J.N., Bryant, R.J., Bernhardt, J.L., Gibbons, J.W. Registration of nine indica germplasm of rice, *Crop Sci.* **45**, 1170-1171 (2005).
37. Rutger, J.N., Beaty, B.A., Bryant, R.J. Registration of early flowering mutant germplasms of indica rice. *J. Plant Registrations* **1**, 154-156 (2007).
38. Rutger, J.N., Bryant, R.J. Development of two early flowering indica germplasms of rice. *Arkansas Rice Research Series* **550**, 124-126 (2007).
39. Rutger, J.N., Lee, F.N., Bryant, R.J. Three early flowering germplasms of a blast disease-resistant indica rice for U.S. rice improvement programmes, *Arkansas Rice Research Series* **550**, 127-131 (2007).
40. Rutger, J.N. Registration of Guichao 2 eui rice genetic stock. *Crop Sci.* **45**, 433 (2005).
41. Rutger, J.N., Carnahan, H.L. A fourth genetic element for facilitating hybrid seed production in cereals a recessive tall in rice. *Crop Sci.* **21**, 373-376 (1981).
42. Rutger, J.N., Bernhardt, L.A. Registration of four indica rice genetic stocks. *Crop Sci.* **47**, 461-462 (2007).
43. GSOR. The Genetic Stocks - Oryza Collection, Dale Bumpers National Rice Research Center, Stuttgart, Arkansas (2006) <http://www.ars.usda.gov/main/docs.htm?docid=8318>.
44. Rutger, J.N., Tai, T.H. Registration of K/Z mapping population of rice. *Crop Sci.* **45** 2671-2672 (2005).
45. Blanco, P.H., Suarez, E., Deus, J.E., Ramirez, J., Navarro, W., Faraco, A.A., Bastos, C.R., Eizenga, G.C., Bollich, C.N., Rutger, J.N., Maluszynski, M. Multi-location yield trials of rice mutants in the Latin American Region. In: Proc. 28th Rice Technical Working Group, Biloxi, Mississippi, 38-39 (2000).
46. Rutger, J.N., Bryant, R.J. Registration of aromatic se rice germplasm. *Crop Sci.* **44**, 363-364 (2004).

Induced Mutations in Plant Breeding and Biological Researches in Japan

H Nakagawa

Abstract

Two hundred and forty two direct-use mutant varieties generated by using irradiation, chemical mutagenesis and somaclonal variations, have been registered in Japan. About 61% of these were induced by Gamma-ray irradiation, largely due to successful collaboration with the Institute of Radiation Breeding. This high percentage of Gamma-ray irradiated mutants indicates that mutation breeding via Gamma-ray irradiation is an effective and highly successful approach for the generation of commercial cultivars. Some mutant cultivars of Japanese pear exhibiting resistance to diseases induced by Gamma-ray irradiation and development of a unique bioassay by using toxins of fungi was discussed. In addition, 228 indirect-use (hybrid) mutant varieties primarily generated in rice and soybean have found value as parental breeding germplasm resources in Japan. In 2005, two direct-use cultivars and 97 indirect-use cultivars of rice contributed approximately 12.4% of the total area of rice cultivation in Japan. The semi-dwarf gene (*sd-1*) generated in rice is perhaps one of the most significant contributions. For soybean, similar Gamma-ray induced mutants comprised nearly 9.4% of the total cultivation area of soybean in Japan. Molecular genetic studies focused on genome sequencing have become an extremely powerful tool for identifying the genes and for selecting mutants exhibiting specific phenotypes. It is anticipated that molecular genetic interaction will complement gains in mutation breeding on a dramatic scale. Chronic irradiation in the Gamma Field is also considered to be a useful tool for generating mutant resources for future molecular studies especially in rice, and expand its use into the other graminaceous crops which have genomic synteny to rice. There are interesting reports concerning mutations in rice, such as low glutelin content, in which the size and location of deletions and the mechanisms and phenotypes of low glutelin content were elucidated. Chronic irradiation in the Gamma Field is useful to generate mutant resources for molecular researches.

Introduction

After the construction of the Gamma Field, now considered the worlds largest radiation field (Fig. 1, 100m radius with an 88.8 TBq ⁶⁰Co source at the center), the Gamma Room and the Gamma Greenhouse in the Institute of Radiation Breeding (IRB) in 1960's, mutation breeding was accelerated by cooperative research with national and prefectural breeding laboratories, private companies and universities in Japan [1].

In *The New York Times* (In "Useful Mutants, Bred With Radiation" by William J. Broad, August 27, 2007), Dr. P. J. L. Lagoda of the Joint FAO/IAEA was quoted to say, "Spontaneous mutations are the motor of evolution. We are mimicking nature in this. We're concentrating time and space for the breeder so he can do the job in his lifetime. We concentrate on how often mutants appear - going through 10,000 to one million - to select just the right one."



Figure 1 Gamma Field of IRB

The concept and objectives of the IRB's Gamma Field has the same goals for the plant breeder. The facility is used to artificially induce mutations at a higher frequency than it occurs in nature. The radiation dose at the nearest point of the field (10m from the center, ca. 2Gy/day) is estimated to be about 300,000 times that of normal and natural background radiation. At the farthest point (100m from the center, ca. 0.01Gy/day), the radiation dosage is about 2,000 times that of normal background radiation. This means that growing plants at the nearest point to the Gamma-ray sources are being treated to a 1,000 year's of accumulated normal background rates of radiation per day. Although we do not know all the genes or mechanism of mutations, radiation breeding has produced many useful mutant cultivars and contributed greatly to the farmers and industries of Japan.

In 1991, the Ministry of Agriculture, Forestry and Fisheries (MAFF) of Japan launched the Rice Genome Research Programme (RGP), with the aim of fully decoding the rice genome in three phases over a 21-year period. With the cooperation of 10 participating countries [2], the genome sequencing of 12 rice chromosomes was completed in 2005 [3]. Following this achievement, molecular genetic studies based on the results of the genome sequencing project became the most powerful tool for selecting mutants of certain characteristics in rice. This is anticipated to revolutionize mutation breeding success in rice, and become applicable to a number of other important crop species.

In this report, the mutant cultivars developed mainly by Gamma-rays are discussed. In addition, their economic impacts in Japan, as well as molecular studies performed to elucidate the mutation at the DNA level are described.

Mutation breeding and released cultivars in Japan

In a 2007 search regarding the number of induced mutation varieties in the IAEA database, China is first in the number of described induced

Institute of Radiation Breeding, National Institute of Agrobiological Sciences, Hitachi-Ohmiya, Ibaraki, Japan

E-mail: ngene@affrc.go.jp

mutation varieties at 638; India is second listing 272 varieties; and Japan is third with 233 varieties. The total number of mutant cultivars, including direct-use mutant cultivars and indirect-use cultivars, exceed these totals. A selection of mutant cultivars developed in Japan, including the economic impact of these cultivars, and their characteristics are reviewed here.

The number of cultivars developed by mutation breeding

Figure 2 shows the number of direct-use and indirect-use (hybrid) mutant cultivars registered in Japan in each five-year period from 1960 to 2005. The number of direct-use cultivars had been rapidly increasing until 1995, when 67 cultivars were registered in five years (about 13 cultivars per year). This number fell from 2001 to 2005, with only 41 cultivars being registered (about 8 cultivars per year). The number of indirect-use cultivars primarily generated in rice has steadily increased over time and 68 cultivars were registered from 2001 to 2005. This number can be increased if agronomically useful, direct-use cultivars, such as “Reimei” with the *sd1* dwarf gene for rice are developed.

Two hundred and forty two direct-use mutant cultivars comprising 61 species generated through irradiation utilizing Gamma-ray, X-ray and ion beams, chemical mutagenesis and *in vitro* culture (somaclonal variation), have been registered and released in Japan (**Fig. 3**). More than 61% of these were induced by Gamma-ray irradiation and those induced by somaclonal variation and chemical mutagen, not including those with double chromosome numbers through colchicine treatment, are 15.7% and 6.6%, respectively. Recently, the development of mutant flower cultivars, generated by ion beam irradiation, has been a growing area of mutation induction in Japan.

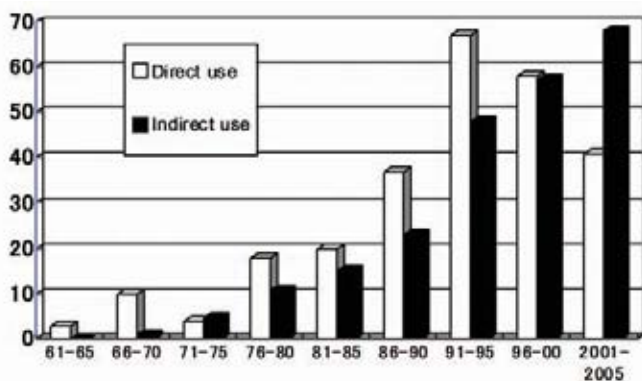

Figure 2 Number of cultivars developed by mutation breeding in each 5-year period from 1961-2005. Total number of direct use cultivars is 212 and that of indirect use cultivars is 230 [4].

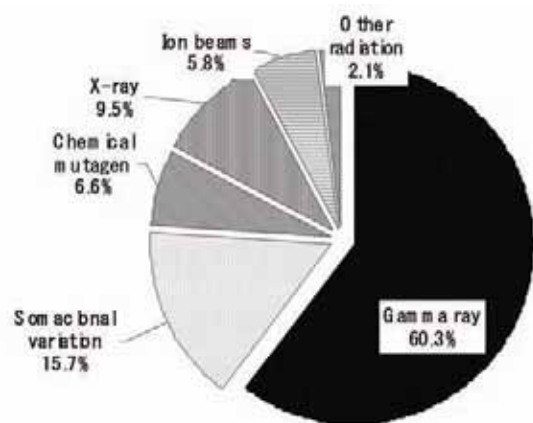

Figure 3 Percentage of total 242 cultivars developed by mutation breeding by using various kinds of methods in Japan (2008). Chemical mutagen does not include colchicine [4].

Table 1 shows the number of registered mutant cultivars of some crops developed by radiation, Gamma-rays, and those irradiated at the IRB, NIAS [4]. There are 50 mutant cultivars of chrysanthemum, 31 of rice, 16 of soybean, 10 of rose, etc. Among them, 100 cultivars have been generated at the IRB and these contributions of the IRB regarding the development and release of superior mutant induced cultivars has been extensive. This high percentage of Gamma-ray irradiated mutants indicates that mutation breeding via Gamma-ray irradiation is an effective and highly successful approach for the generation of commercial cultivars.

The first mutant rice cultivar is “Reimei,” which means “dawn” in Japanese, was the first irradiation induced mutant cultivar that illustrated the potential of utilizing Gamma-rays for breeding improvements in Japan. Reduction of plant height, including dwarfism and semi-dwarfism is one of the characteristics that can be induced with high frequency by irradiation and can be easily detected in the field. “Reimei,” registered in 1966 [5] was a successful case of an irradiation induced semi-dwarf mutant. This cultivar exhibits a mutation of the *sd-1* locus [6] and shows a culm 15cm shorter than the original cultivar “Fujiminori.” The semi-dwarf is associated with the high-yielding ability and recorded the highest yield in Japan in 1967 [5].

Table 1. Number of registered mutant cultivars developed by radiation, Gamma-rays, and those irradiated in the Institute of Radiation Breeding, NIAS [4]

	Mutant cultivars ¹	Radiation	Gamma-rays	IRB ²
61 Crops	242	188	146	100
Rice	31	14	12	11
Wheat	4	2	2	0
Barley	4	4	3	0
Soybean	16	16	15	9
Chrysanthemum	50	46	32	29
Rose	10	7	7	6
Sea pink (Limonium)	6	6	6	0
Cytisus	8	8	8	8
Apple	2	2	2	2
Japanese Pear	3	3	3	3
Others	108	80	56	32

¹ Total number of mutant cultivars developed by radiation (Gamma-ray, X-ray and ion beams), chemicals (Excluding colchicine treatment), somaclonal variation

² Number of mutant cultivars irradiated in the Institute of Radiation Breeding (IRB)

Table 2. Number of indirect use mutant cultivars in Japan (2008)

Rice	Wheat	Barley	Soybean	Tomato	Others	Total
198	3	7	9	3	7	228

In Japan, the total number of indirect-use mutant cultivars is 228, which includes 198 rice, 9 soybean, 7 barley, 3 wheat, 3 tomato, 4 lettuce, 1 eggplant, 1 Japanese lawngrass, 1 mat rush, and 1 mushroom cultivar in 2008 (**Table 2**). Interestingly, among the 198 indirect-use mutant cultivars in 2008, 89 cultivars (44.9%) were derived from the “Reimei” or its offspring. This suggests that agronomically useful mutations can be utilized as parental lines to develop new varieties with this characteristic and transferred efficiently to the farmers’ field.

The Economic impact of mutant cultivars in Japan

Figure 4 shows the increase of mutant rice cultivars, which were derived from mutants generated by Gamma-rays, planted in farmers’ fields in Japan since 1960. “Reimei” was first cultivated on 61,598 ha in 1968,

(<http://ineweb.narcc.affrc.go.jp/>). The number of mutant cultivars has been increasing and 99 mutant cultivars (2 direct-use and 97 indirect-use cultivars) were in cultivation in 2005 [4].

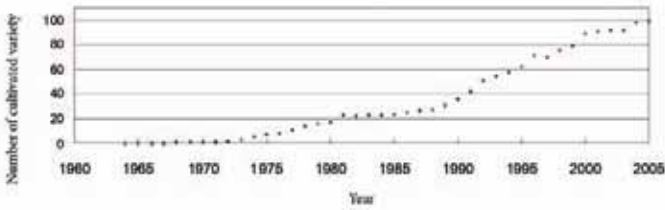

Figure 4 Total number of mutant rice cultivars, which are derived from mutants generated by Gamma-rays, cultivated in farmers' field from 1960 to 2005 in Japan [4].

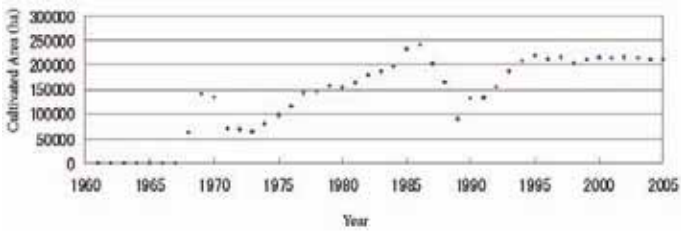

Figure 5 Total areas of mutant rice cultivars, which are derived from mutants generated by Gamma-rays, cultivated in farmers' field from 1960 to 2005 in Japan [4].

Figure 5 shows the total cultivated field of the mutant cultivars, which are derived from mutants generated by Gamma-rays, from 1961 to 2005. This increased after “Reimei” was released for cultivation in 1968. The peak use of mutant induced cultivars reached 250,000 ha in 1986 and was slightly more than 200,000 ha from 1994 to 2005. In 2005, the total cultivated area of mutant cultivars was 210,692 ha, which is 12.4% of total cultivated area of paddy rice (1,702,000 ha) in Japan [4].

The total crude income of farmers selling the brown rice of mutant cultivars also has been increasing as the increase of the cultivated area, although the price of the grain is different in each year. The amount of total income is estimated to be approximately 250 billion Yen (2.34 billion US dollars) in 2005 [4]. The mutant cultivars, which are derived from mutants generated by Gamma-rays and have been cultivated on more than 5,000 ha from 2001 to 2005, are the following 17 cultivars, “Kinuhikari (263,223ha)”; “Haenuki (219,734ha)”; “Tsugaru-roman (106,423ha)”; “Yume-akari (66,491ha)”; “Yume-tsukushi (58,893ha)”; “Aichi-no-kaori (53,697ha)”; “Asahi-no-yume (51,049ha)”; “Mutsuhomare (46,959 ha)”; “Dontokoi (17,008ha)”; “Yume-shizuku (14,076ha)”; “Mine-asahi (10,698 ha)”; “Yume-hitachi (10,440ha)”; “Yume-minori (9,957ha)”; “Aki-geshiki (7,510ha)”; “Aki-roman (7,450ha)”; “Miyama-nishiki (7,242 ha)”; and “Tsukushi-roman (5,533 ha).” The mutant cultivars, which have been cultivated in more than 100,000ha of farmers' fields are the following 5 cultivars, “Akihikari (1,410,810ha)”; “Reimei (886,188ha)”; “Kinuhikari (263,223ha)”; “Haenuki (219,734ha); and “Tsugaru-roman (106,423ha).” Among them, “Reimei” is a direct-use mutation cultivar and the others are indirect-use cultivars [4].

There are 16 direct-use mutant cultivars of soybean registered in Japan since “Raiden” and “Raikou” were developed by Gamma-ray irradiation in 1960. The improved characteristics were early-maturity and late-maturity, yellow hilum, seed-coat color, short-stem, and the number of pods/stem, lipoxygenase-free, low allergen etc. Among them, one cultivar was induced by X-ray and the other 15 were induced by Gamma-rays. The number of indirect-use cultivars is 10. The total cultivated area of mutant cultivars cultivated in the farmers' fields came to 13,283 ha (9.4% of total cultivated area (142,000ha) of soybean in Japan in 2005)

and total farmers' crude income was 5.56 billion Yen (ca. 52 million US dollars) [4]. As a result, economic impact of mutant cultivars is huge in Japan.

Some useful mutant varieties by using various screening methods

Rice

Although rice is not a high protein grain crop, the protein content is ca. 7% when the white rice is cooked. A mutant line with a low content of glutelin was obtained from the ethyleneimine (EI) treatment to “Nihonmasari.” The “LGC-1” was developed from back-crossing this mutant with the original “Nihonmasari” to eliminate undesirable characteristics, such as semi-sterility and semi-dwarfism [7]. The seed protein of the “LGC-1” is composed of mainly of a low amount of digestible glutelin and high amount of indigestible prolamine. This construction of protein is disadvantageous for the digestion of rice grains in humans, though the total amount of protein is mostly similar to the original cultivar. As a result, the “LGC-1” is useful as “low protein rice,” and some clinical trials on patients with kidney disease indicate that the variety is a useful and effective daily food for such patients [8]. The defect of the “LGC-1” is its eating quality, and there are the other loci that control the biosynthesis of digestible protein, such as globulin. Therefore, Nishimura, *et al.* [9] induced a mutant named “89WPKG30-433” with a deficiency in globulin from the leading Japanese cultivar “Koshihikari” through Gamma-ray irradiation. They hybridized it with the “LGC-1” and selected “LGC-Katsu” and “LGC-Jun” from the hybrids, whose globulin content was as low as the “LGC-1,” where the globulin content is zero. The total digestible protein content tested to about 30% of ordinary rice. As the eating quality is highly improved and digestible protein content is lower than “LGC-1,” these two cultivars will greatly help in the dietary management of proteins with chronic renal failure.

Soybean

Takagi [10] identified two major genes, which control radio-sensitivity, in some soybean varieties. When the 50% reduction rate (RD₅₀) of root length was determined with acute irradiation to the seeds or the chronic irradiation to the plants for the entire growth period, radio-sensitivity of a sensitive cultivar, “Shinmejiro,” is more than twice that of the resistant variety, “Tachisuzunari.” The differences in radio-sensitivity between the varieties to the chronic irradiation in the Gamma Field were controlled by a single recessive gene, *rs1*. Besides, the second recessive gene *rs2*, which was discovered in “Goishishirobana,” whose activity is only expressed following acute seed radiation.

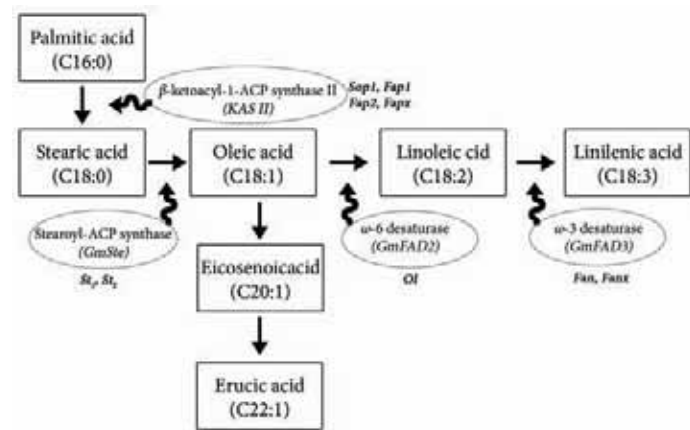

Figure 6 Metabolic pathway and key genes of fatty acid in soybean [13] (courtesy of Prof. Y. Takagi).

Soybean is the most widely used source of edible oil for human consumption. Fatty acids of soybean seeds consist of palmitic acid, stearic acid, oleic acid, linoleic acid, and linolenic acid (Fig. 6). Altered unsaturated fatty acid content (elevated oleic acid and reduced linolenic acid) increase the oxidative stability that provides health benefits and improvement of fatty acid contents. This has been one of the most important breeding objectives of soybean. As natural genetic diversity in soybean is limited, mutation induction is one effective approach to induce modification. Through the use of X-rays or chemical mutagens, mutants with different fatty acid compositions, such as reduced and elevated palmitic acid, elevated stearic acid, elevated oleic acid (50%), and reduced linolenic acid (3%) content were isolated and found to be controlled by major genes (Fig. 6; [11-13]).

Soybean seed has three lipoxygenases called *L-1*, *L-2* and *L-3*, respectively [14]. The lipoxygenases are the main factors of the grassy-beany flavor of the products. Soybean lines lacking each of the three genes have been developed. However, no line lacking all three genes has been obtained because of tight linkage between *L-1* and *L-2* [15]. The F_2 seeds derived from a cross between a line without *L-1*, *L-3* and a line without *L-2*, *L-3* were irradiated with Gamma-rays. After surveying 1,813 M3 seeds by using SDS/PAGE, one mutant seed lacking all *L-1*, *L-2*, and *L-3* was selected [16]. A new cultivar "Ichihime" with this unique characteristic was registered and released in 1994 [17].

Italian ryegrass

Mutation breeding has been mainly established in seed propagated, self-pollinated species. Although several methods have been widely used for the screening of mutants in self-pollinated species by the single-seed descent approach [18,19] and by single seed descent (one-plant-one-grain method, Yoshida [20]), these methods have not been applied to cross-pollinated species. Ukai [21] developed a new method for obtaining mutants of cross-pollinated species efficiently in a temperate forage grass, Italian ryegrass (*Lolium multiflorum* L.). The method was called the "Crossing-within-Spike-Progenies Method." This method is composed of 1) taking seeds separately from each spike from a population of plants irradiated with Gamma-rays, 2) sowing the seeds in a hill plot as a spike-progeny, 3) isolating each hill from others at the time of flowering and allowing the open-pollination of plants within hills, and 4) taking seeds from each of the hills and sowing the seeds in hill progenies for the screening of mutants. This procedure is repeated each year. When 300Gy of Gamma-ray was irradiated to the seed, the frequency of chlorophyll mutations was approximately 70.6% per hill progeny and 1.87% per plant. In contrast, open-pollinated populations exhibited that only 10% per progeny and 0.12% per plant, respectively. This method will be applied to the other wind- or insect-pollinating outcrossing crop species.

Chrysanthemum

In general, it is very difficult to isolate mutants from mutation sectors in vegetatively propagated crops although the maintenance of mutant genotypes is easier than the seed-propagated species. It has been shown that the combined method of chronic Gamma-ray irradiation and tissue culture is very effective in solving this problem. By tissue culturing the floral organs of chrysanthemum (*Chrysanthemum morifolium* Ramat.) plants chronically irradiated in the Gamma Field from the seedling to the flowering stages, many non-chimeric mutants, with various flower colors and shapes, are obtained [22]. From these mutant lines, 10 cultivars were registered. The technology, given the term "radiobiotechnology," is not only effective in obtaining non-chimeric mutants but also effective in producing high mutation frequencies. The method has been utilized to induce mutations in various vegetatively propagated crops and many mutant cultivars have been registered.

Japanese pear and apple resistant to *Alternaria* disease

A popular cultivar of Japanese pear (*Pyrus serotina* Rehd. var. *culta* Rehd.), "Nijisseiki," which was a leading variety, occupied 28% of the total cultivated area of Japanese pear in 1990 in Japan. The cultivar, however, is highly susceptible to the black spot disease, *Alternaria alternata* (Fr.) Keissier (= *Alternaria kikuchiana* Tanaka), one of the most serious diseases of pear [23]. Growers are required to spray fungicides several times during the growing season to counter the disease. To induce mutations resistant to the disease by Gamma-ray irradiation, small plants of the cv. "Nijisseiki" were planted at every 4 meters from 37 m to 63 m from the ^{60}Co source in 1962 and chronic Gamma-ray irradiation was applied (30 x 10-2Gy - 4 x 10-2Gy /day) in the Gamma Field [24]. In 1981, nearly 20 years after the planting, a twig without the symptom of the disease was found in a plant planted at a distance of 53 m from the irradiation source. As it was ascertained that there was no difference in other agronomic characteristics between the mutant and the original variety except for the resistance to the black spot disease, it was registered and released in 1991 with the name "Gold Nijisseiki" [24]. It was registered as the same name in Australia in 2004 (Certificate Number 2533).

Dr. Sanada, one of the breeders of this cultivar, mentioned, "The situation of mutation breeding on fruit trees has been severely criticized because there have been no successful results." Although it took them nearly 20 years to identify a useful mutation and 30 years for the registration, the release of "Gold Nijisseiki" is a monumental achievement for the Gamma Field.



Figure 7 Bioassay of resistant to the black spot disease by using the AK-toxin obtained from the culture of the fungus. Upper to lower leaf disc (1 – 5) means 1 (young) to 5 (older) leaf; cv. "Chojuuro", highly resistant; cv. "Nijisseiki", highly susceptible; cv. "Gold Nijisseiki", resistant.

At the same time an easy and effective method for the screening of resistance to the fungus has been developed by treating leaf discs (7 mm in diameter) by the AK-toxin produced by the fungus [25]. It was coincidental and lucky for the breeders that Nakashima, *et al.* [26,27] isolated and identified the chemical structure of the toxin named "AK-toxin" produced by the fungus of black spot disease and generating the symptom of black spots on leaves at the same time. As a consequence, the breeding group entered into a cooperative research programme with the chemistry group and established this unique method. When the leaf discs are placed on the filter paper soaked with AK-toxin obtained either from the extract of the fungal body or artificial synthesis in a Petri dish, and kept for two or three days, susceptible leaves turned to black and resistant leaves stayed green (Fig. 7). After the development of this method, two new mutant varieties, "Osa-Gold [28,29]" and "Kotobuki Shinsui [30]"

were developed in a short period of time by using this screening method. The economic effect of this research has been great [4].

These researches suggest that the breeding of fruit trees requires patience and that development of easy and precise screening methods is a very important addition to the development of methods for mutation induction.

Achievement of biological researches on mutations induced by Gamma-ray irradiation

Deletion size generated by Gamma-ray

Naito, *et al.* [31] studied the deletion sizes of transmissible and non-transmissible mutations induced with Gamma-ray and carbon ion beam irradiation by the sophisticated pollen-irradiation methods in *Arabidopsis*. It has been revealed that most mutants induced with these ionizing irradiations possess extremely large deletions (more than 6 Mbp), most of which are not transmittable to the next generation, as well as small deletions (1 or 4 bp), which are normally transmissible.

In rice, the same tendency was observed in transmissible mutants. Morita (unpublished) researched the frequency of transmission of different mutations possessing different deletion sizes as obtained with Gamma-ray irradiation in rice. Among 11 Gamma-ray induced mutants, one *GluA2* mutant exhibited 1 base pair (bp) substitution, and among 10 mutants with a deletion, the deletion size of 6 mutants, which include *CAO* (*chlorophyllide-a oxygenase*), *GA3os* (*GA3-beta-hydroxylase*), *GluA1* (*glutelin A1*), and *GluA2* (*glutelin A2*) are 1 bp deletion, and those of the other *CAO* mutants and *PLA1* (*Plastochron1*) are 3 and 5 bp deletions, respectively. Those of *GluB4/5* (*Glutelin B4/5*), two α -globulin mutants are more than 10 kbp, 15 kbp, and 90 kbp, respectively. It is very interesting that the Gamma-ray induced mutations transmittable to the next generation are primarily classified into 2 groups, the one with extremely a large deletion and the other with small deletions (1 to 5 bp). We are not sure whether or not it is very difficult to obtain mutants with medium deletion size by Gamma-ray irradiations. However, we are accumulating data to elucidate it.

Different size and location of deletion generates different kinds of phenotypes

In the course of plant evolution, genes are often duplicated in tandem, resulting in a functional redundancy. The analysis of function of these genes by developing double mutants might be difficult because they would be very tightly linked. Mutants of such tandem duplicated genes were investigated for their genotypes and phenotypes. There are reversely repeated two loci, which both codes for mRNA of glutelin production. There are various mutants that exhibit low glutelin contents isolated by SDS-PAGE [7, 32]. The mechanisms of low glutelin contents of mutants that have been studied suggest that the size and the position of deletions generate different characteristics of mutations. Some act as dominant genes or recessive genes, and those relationships between genotypes and phenotypes, etc. are provided as example below.

Mechanism of low glutelin content in the “LGC-1” mutant

The *Low glutelin content* (*Lgc-1*) is a dominant mutation that reduces glutelin content in the rice grain. Glutelin is a major digestible seed storage protein encoded by a multigene family. Kusaba, *et al.* [33] reported that in *Lgc-1* homozygotes, there is a 3.5 kbp deletion between two highly similar glutelin genes that forms a tail-to-tail inverted repeat, that might produce a double stranded RNA molecule, a potent inducer of RNA silencing (Fig. 8). As a result, glutelin synthesis is suppressed and the glutelin content is lowered. The *Lgc-1* provides an interesting example of RNA silencing occurring among genes that exhibit various levels of similarity to an RNA-silencing-inducing gene. This was the first report that shows the mechanism of a mutation was RNAi.

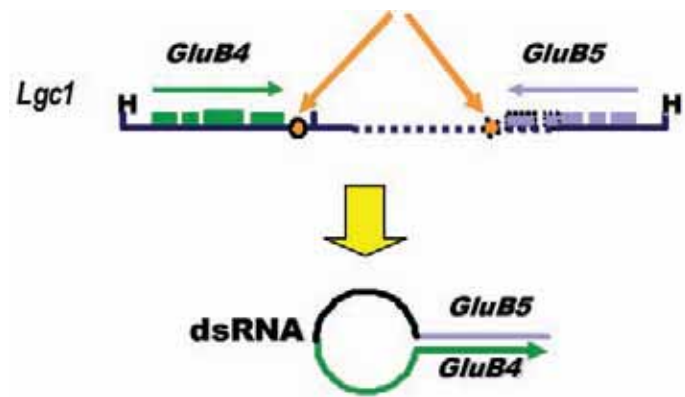

Figure 8 Mechanism of low glutelin in LGC-1 through a deletion at the transcription termination signal and produced double-stranded RNA suppress the glutelin synthesis by RNAi [33] (by courtesy of Prof. M. Kusaba, Hiroshima University).

Mechanism of low glutelin content in the “glu1” mutant

The “*glu1*” is a gamma-ray-induced rice mutant, which lacks an acidic subunit of glutelin, a major seed storage protein. Morita, *et al.* [34] elucidated that the *glu1* harbors a 129.7 kbp deletion involving two highly similar and tandem repeated glutelin genes, *GluB5* and *GluB4*. The deletion eliminated the entire *GluB5* and *GluB4* gene except half of the first exon of *GluB5*. As a result, the phenotype of the *glu1* gene is a complete lack of the acidic subunit of glutelin and acts as a recessive gene for low glutelin content in rice grains (Fig. 9).

Conclusion

The above examples illustrate that the position and the size of deletions in the same loci have the capacity to dramatically alter the phenotype of mutants through the process of transcription and translation. The *glu1*, which has a large 129.7 kbp deletion, acts as a recessive gene, while the *LGC1*, which has 3.5 kbp deletion including probably a terminal signal of the transcript region acts as a dominant gene.

Furthermore, the *GluB5* and the *GluB4* have the same amino acid sequence in their acidic subunit, suggesting that only the mutation involving both *GluB5* and *GluB4* result in the resultant phenotype. That is the lack of the glutelin acidic subunit deleted in the “*glu1*” mutant. It probably is very difficult to knock out both loci by chemical treatment or transposon techniques. Sequenced plant genomes exhibited more than 14% of the genes formed tandem array [3, 35]. This finding, however, suggests that Gamma-rays can be an effective mutagen to generate knock-out mutants of both loci and to analyze tandem repeated and functionally redundant genes.

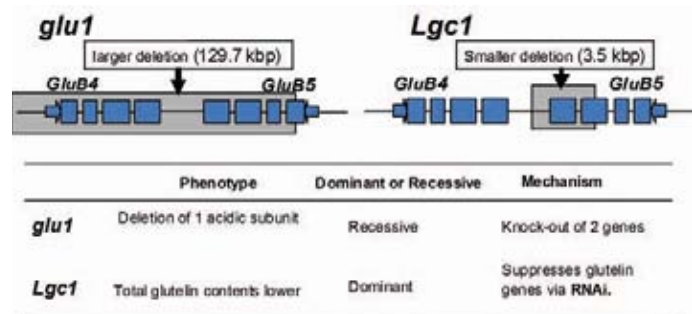

Figure 9 Comparison of phenotype, mode of inheritance and mechanism of mutation character between *glu1* and *Lgc1* mutation with different size and place of deletion in the same region of 2 loci, *GluB4* and *GluB5* (by courtesy of Dr. R. Morita, IRB, NIAS). *glu1*, Morita *et al.* [34]; *Lgc1*, Kusaba *et al.* [33]

Genetic studies by the useful mutations induced with Gamma-ray chronic irradiation

As the history has shown, spontaneous and induced mutation resources have played an important role not only for mutation breeding but also genetic studies and the elucidation of gene functions.

Phytochrome

Takano, *et al.* [36] have isolated *phytochrome B* (*phyB*) and *phy C* mutants from rice and have produced all combinations of double mutants. Seedlings of *phy B* and *phyB phyC* mutants exhibited a partial loss of sensitivity to continuous red light but still showed significant deetiolation responses. The responses to red light were completely canceled in *phyA phyB* double mutants. These results indicate that *phyA* and *phyB* act in a highly redundant manner to control deetiolation under red light. They also found that mutations in either *phyB* or *phyC* locus causes moderate early flowering under a long-day photoperiod, while monogenic *phyA* mutations had little effect on flowering time. The *phyA* mutation, however, in combination with *phyB* or *phyC* mutation caused dramatic early flowering. Early flowering mutants were generated by chronic Gamma-ray irradiation with dose rates ranging between 3 and 6Gy/day [36].

Aluminum tolerance

Ma, *et al.* [37] isolated a mutant with highly sensitivity to aluminum concentration from cv. Koshihikari of japonica rice, which has an aluminum resistance [38]. The mutant was induced with chronic Gamma-ray irradiation and exhibited the same phenotype to the wild type with the absence of aluminum. That is, M₁ plants were irradiated in the Gamma Field from seven days before heading to two days after heading under 20Gy/day for eight days. The root elongation of the mutant, however, was highly inhibited in the presence of 10 µM Al. The mutant also exhibited poorer root growth in acid soil. Genetic analysis showed that the high sensitivity to Al is controlled by a single recessive gene. The gene was mapped to the long arm of chromosome 6.

Conclusion

The Gamma Phytotron was established in Korea in 2005 and the Gamma Greenhouse, approximately doubled the size of the Gamma Greenhouse located at the IRB, Japan, was established in Malaysia in 2008. Both facilities are focused on the induction of mutation by chronic Gamma-ray irradiation to growing plants of important crop species. As described earlier in this report, chronic irradiation is a useful tool for the generation of mutant genome resources that have application toward molecular analysis as well as conventional breeding.

Conclusions

A. M. van Harten [39] describes in “Mutation Breeding -Theory and practical application,”

“An explanation for the decreasing interest in mutation breeding, at least in most “developed” countries, may be that during the past two decades attention has become more and more directed towards studying the possibilities offered to plant breeding by various new molecular technologies...As a result of these developments mutation breeding seems to have lost part of its previous attraction for young researchers.”

It is not necessary to mention, however, that mutation breeding is still a very interesting and useful technology for isolating genes and for elucidating gene mechanisms and metabolic pathways in various crops.

The record has also shown that mutation induction is a very useful conventional breeding tool for developing superior cultivars. Today, site-directed mutagenesis *in vivo* or *in vitro* cell can be envisioned and many researchers are conducting programmes in this direction.

New fields of science and technologies were developed on the basis of achievements of traditional or classic methods. It is highly desirable that

the IRB continues their work while incorporating the new knowledge and technologies. The IRB is well equipped with appropriate facilities and equipment that will contribute to the future mutation breeding developments and be a contributor in solving the problems mentioned in this review.

ACKNOWLEDGEMENTS

Author would like to express his sincere thanks to Dr. Bryan Kindiger, USDA, ARS-SR, Grazinglands Research Laboratory for his critical reading of the manuscript.

BIBLIOGRAPHY

1. Yamaguchi, I. Forty years of mutation breeding in Japan - Research and fruits. *Gamma Field Symposia* **40**, 1-14 (2001).
2. Sasaki, T., Burr, B. International Rice Genome Sequencing Project: the effort to completely sequence the rice genome. *Curr. Opin. Plant Biology* **3**, 138-141 (1998).
3. International Rice Genome Sequence Project. The map-based sequence of the rice genome. *Nature* **436**, 793-800 (2005).
4. Nakagawa, H. Mutation breeding, status quo and future. *Techno Innovation* **68**, 6-12 (2008) (in Japanese).
5. Futsuhara, Y. Breeding of a new rice variety Reimei by gamma-ray irradiation. *Gamma Field Symposia* **7**, 87-109 (1968).
6. Ashikari, M. *et al.* Loss-of-function of a rice gibberellin biosynthetic gene, GA20 oxidase (GA20ox-2), led to the rice 'Green Revolution'. *Breeding Science* **52**, 143-150 (2002).
7. Iida, S. *et al.* A rice (*Oryza sativa* L.) mutant having a low content of glutelin and a high content of prolamine. *Theor. Appl. Genet.* **87**, 374-378 (1993).
8. Mochizuki, T. Hara, S. Usefulness of low protein rice in diet therapy in patients with chronic renal failure. *Jpn. J. Nephrol.* **42**, 24-29 (in Japanese with English summary).
9. Nishimura, M. *et al.* New rice varieties with low levels of easy-to-digest protein, 'LGC-Katsu' and 'LGC-Jun'. *Breeding Science* **55**, 103-105 (2005).
10. Takagi, Y. The second type of gamma-ray sensitive gene RS2 in soybean *Glycine max* (L.) Merrill. *Gamma Field Symposia* **8**, 83-94 (1969).
11. Takagi, Y. *et al.* Construction of novel fatty acid composition in soybean oil by induced mutation. *Gamma Field Symposia* **37**, 17-28 (1998).
12. Anai, T. *et al.* Identification of corresponding genes for three low- α -linolenic acid mutants and elucidation of their contribution to fatty acid biosynthesis in soybean seed. *Plant Science* **168**, 1615-1623 (2005).
13. Takagi, Y., Anai T. Development of novel fatty acid composition in soybean oil by induced mutation. *Oleoscience* **6**(4), 195-203 (in Japanese with English abstract) (2006).
14. Arai, S. *et al.* N-Hexanal and some volatile alcohols. Their distribution in row soybean tissue and formation in crude soy protein concentrate by lipoxygenase. *Agric. Biol. Chem.* **34**, 1420-1423 (1970).
15. Kitamura, K. *et al.* Inheritance of lipogenase-2 and genetic relationships among genes for lipogenase-1, 2 and -3 isozymes in soybean seeds. *Jpn. J. Breed.* **35**, 413-420 (1985).
16. Hajika, M. *et al.* A line lacking all the seed lipogenase isozymes in soybean (*Glycine max* (L.) Merrill) induced by gamma-ray irradiation. *Jpn. J. Breed.* **41**, 507-509 (1991).
17. Hajika, M. *et al.* A new soybean variety 'Ichinose'. *Bull. Nat. Agric. Res. Cent. Kyushu Okinawa Reg.* **40**, 79-93 (2002) (in Japanese with English summary).
18. Stadler, L.J. Some genetic effects of X-rays in plants. *J. Hered.* **21**, 3-19 (1930).
19. Nybom, N. Mutation type in barley. *Acta Agric. Scand.* **4**, 430-456 (1954).
20. Yoshida, Y. Theoretical studies on the methodological procedures of radiation breeding. I. New methods in autogamous plants following seed irradiation. *Euphytica* **11**, 95-111 (1962).
21. Ukai, Y. Application of a new method for selection of mutants in a cross-fertilizing species to recurrently mutagen-treated populations of Italian ryegrass. *Gamma Field Symposia* **29**, 55-69 (1990).
22. Nagatomi, S. Combined effect of gamma irradiation methods and *in vitro* explant sources on mutation induction of flower color in *Chrysanthemum morifolium* RAMAT. *Gamma Field Symposia* **35**, 51-69 (1996).

23. Nishimura, S. *et al.* Two different phases in pathogenicity of the *Alternaria* pathogen causing black spot disease of Japanese pear. *J. Fac. Agr. Tottori Univ.* **13**, 1-10 (1978).
24. Sanada, S. *et al.* A new Japanese pear cultivar 'Gold Nijisseiki,' resistant to black spot disease of Japanese pear. *Jpn. J. Breed.* **43**, 455-461 (1993) (in Japanese with English summary).
25. Sanada, S. Selection of resistant mutants to black spot disease of Japanese pear by using host specific toxin. *Jpn. J. Breed.* **38**, 198-204 (1988).
26. Nakashima, T. *et al.* Structure elucidation of AK-toxins, host specific phyto-toxic metabolites produced by *Alternaria kikuchiana* Tanaka. *Tetrahedron Lett.* **23**, 4469-4472 (1982).
27. Nakashima, T. *et al.* Isolation and structure of AK-toxin I and II. Host-specific phytotoxic metabolites produced by *Alternaria alternata* Japanese phytotype. *Agri. Biol. Chem.* **49**, 807-815 (1985).
28. Masuda, T. *et al.* Selection of mutants resistant to black spot disease by chronic irradiation of gamma-rays in Japanese pear 'Osaniijisseiki'. *J. Japan. Hort. Sci.* **66** (1), 85-92 (1997).
29. Masuda, T. *et al.* A new Japanese pear cultivar 'Osa Gold,' resistant mutant to the black spot disease of Japanese pear (*Pyrus pyrifolia* Nakai) induced by chronic irradiation of gamma-rays. *Bull. Natl. Inst. Agrobiological Resources* (Japan) **12**, 1-11 (1999) (in Japanese with English summary).
30. Kitagawa, K *et al.* A new Japanese pear cultivar, 'Kotobuki Shinsui'. *Bull. Tottori Hort. Expt. Str.* **3**, 1-13 (1999) (in Japanese).
31. Naito, K. Transmissible and non-transmissible mutations induced by irradiating *Arabidopsis thaliana* pollen with γ -rays and carbon ions. *Genetics* **169**, 881-889 (2005).
32. Iida, S. *et al.* Mutants lacking glutelin subunits in rice: mapping and combination of mutated glutelin genes. *Theor Appl Genet* **94**, 177-183 (1997).
33. Kusaba, M. *et al.* *Low glutelin content1*: A dominant mutation that suppresses the glutelin multigene family via RNA silencing in rice. *Plant Cell* **15**, 1455-1467 (2003).
34. Morita, R. *et al.* Knockout of glutelin genes which form a tandem array with a high level of homology in rice by gamma irradiation. *Genes Genet Syst.* **82**, 321-327 (2007).
35. Arabidopsis Genome Initiative. Analysis of the genome sequencing of the flowering plant *Arabidopsis thaliana*. *Nature* **408**, 796-815 (2000).
36. Takano, M. *et al.* Distinct and cooperative function of phytochromes A, B, and C in the control of deetiolation and flowering in rice. *Plant Cell* **17**, 3311-3325 (2005).
37. Ma, J.F. *et al.* Isolation and characterization of a rice mutant hypersensitive to Al. *Plant Cell Physiol.* **46**, 1054-1061 (2005).
38. Wu, P. *et al.* Genetic control of seedling tolerance to aluminum toxicity in rice. *Euphytica* **97**, 289-293 (1997).
39. Van Harten, A.M. Mutation breeding –theory and practical breeding. Cambridge University Press, Cambridge, UK (1998).

Mutation Breeding in Oilseeds and Grain Legumes in India: Accomplishments and Socio-Economic Impact

S F D'Souza*, K S Reddy, A M Badigannavar, J G Manjaya & S J Jambhulkar

Abstract

In India, oilseed and legume crops are important food components as they are major contributors to dietary oils and proteins. In order to generate genetic variability in these crops, mutation research is extensively carried out at Bhabha Atomic Research Centre (BARC), Mumbai for the past half a century. Besides cytogenetic studies, the era of direct mutants as crop varieties began in groundnut, mustard, pigeonpea and mungbean. Induction of modified traits and their incorporation in an ideal genotype was achieved by judicious use of induced mutation and hybridization techniques. So far, 110 varieties in oilseed and legumes have been developed in India by incorporating desirable traits like large seed, semi-dwarf habit, high harvest index, better partitioning, fresh seed dormancy, yellow seed color, drought tolerance, resistance to powdery mildew, yellow mosaic virus, and bacterial pustule diseases. Many of the national/state breeding programmes have been utilizing these varieties as parental materials/donors and developed several improved varieties. Several of these varieties have high patronage from the farming community and are extensively grown in the country. Groundnut varieties have made considerable impact by giving record yields across the country. Further, mungbean varieties were also surging ahead by virtue of their resistance to yellow mosaic virus, *Rhizoctonia* root-rot and powdery mildew diseases with suitability to rice fallow situations. Blackgram variety TAU-1 has occupied maximum blackgram area in Maharashtra state. These varieties also facilitated farmers to develop newer cropping systems. Thus, induced mutation research remained in the forefront of Indian agricultural research by developing popular varieties with higher productivity potential in oilseeds and legumes.

Introduction

India produces variety of oilseeds and grain legumes, which constitute around 12% and 7% of the total food grain production, respectively [1]. Large proportion of Indian population relies on grain legumes as a dietary source of proteins due to economic or cultural reasons. India is the fifth largest oilseed producer accounting for 8% of the global oilseed production. Soybean contributes 31.4%, rapeseed/mustard 28.2%, groundnut 27.7% and sunflower 4.8% to Indian oilseed production [1, 2]. Among the food legumes, chickpea is the major Indian legume contributing 40.2% to country's total legume production followed by pigeonpea (17.4%), blackgram (10.6%) and mungbean (8.6%) [1]. National productivity levels compare poorly with rest of the world. In 2006, India imported 4.17 million tonnes of edible oils and 1.61 million tonnes of legumes worth of 2.57 billion USD [1]. Annual consumption of these is expected to increase further with increased urbanization, higher disposable incomes and burgeoning population, necessitating more imports. Many of the issues attributed to lower productivity were narrow genetic base, lack of tolerance to biotic and abiotic stresses, lack

of quality seeds of improved varieties and restriction of these crops on marginal areas with poor inputs.

Development of mutant varieties in oilseeds and grain legumes

Mutation breeding has played a significant role in the last 75 years by releasing around 2,672 mutant varieties for commercial cultivation in the world [3]. The major contribution is from cereals followed by ornamentals, legumes and oilseeds. Most of mutant varieties were released in China (27.7%), India (12.7%), Russia (9.8%), Japan (8.7%), Germany (6.5%), Netherlands (6.5%), USA (4.7%) and others (22.9%). Many induced mutants were released directly as new varieties, others used as parents to derive new varieties. Nearly 400 mutant varieties have been released in oilseeds and legumes in the world, of these 110 varieties were released from India.

In India, mutation breeding is being carried out in several national/state universities/institutes like Bhabha Atomic Research Centre (BARC), Indian Agricultural Research Institute (IARI), National Botanical Research Institute (NBRI), Tamil Nadu, Agricultural University (TNAU), etc. Under the peaceful uses of atomic energy in agriculture, BARC had initiated radiation based mutation techniques for the genetic enhancement of oilseeds and legumes more than five decades back. At present, BARC has been concentrating on major oilseeds of country's interest like groundnut, mustard, soybean, sunflower and legumes such as pigeonpea, mungbean, blackgram and cowpea [4]. Initial research activities focused on the effect of radiation on oilseeds and legumes, induction of wide spectrum of mutants for various traits, and genetic and cyto-genetical studies of mutant traits. In most of the mutation experiments, the objectives were to develop high-yielding varieties with early maturity, large seed, high oil content, moderate seed dormancy, ideal ideotype, tolerance to biotic and abiotic stresses and improved seed quality traits. Both chemical and physical mutagens were used for induced mutagenesis in oilseeds and legumes. Initial germplasm used for mutagen treatment was seeds of cultivar, mutant, selection, hybrids or advanced lines. Induced mutants are utilized directly for varietal development or in recombination breeding by hybridizing mutant X mutant, mutant X cultivar, mutant derivative X mutant or mutant derivative X cultivar. Varietal development using mutation with recombination breeding in oilseeds and grain legumes and their accomplishments and societal impact is briefly discussed here.

Sustained induced mutagenesis in oilseeds and grain legumes using X-rays, beta rays, Gamma-rays, fast neutrons, ethyl methane sulphonate and sodium azide resulted in wide spectrum of mutants affecting various traits (Table 1). Of these, six mutants of groundnut, three of sesame and one of sunflower were registered with National Bureau of Plant Genetic Resources (NBPGR), New Delhi for their mutant traits. First groundnut mutant, TG 1 with superior agronomic performance was released for commercial cultivation in 1973 [5]. Later research efforts with the initial X-ray irradiation followed by intermittent gamma irradiation and cross breeding exploited interaction of mutant X mutant, mutant X cultivar, mutant X breeding line genomes in turn resulted in wide spectrum of

Nuclear Agriculture and Biotechnology Division, Bhabha Atomic Research Center, Trombay, Mumbai – 400085, India

* Corresponding author. E-mail: stanfndsouza@gmail.com

genetically diverse, agronomically important breeding lines. Planned irradiation had broken undesirable linkages and enhanced favorable recombinants. As a result, traits like large seed, increased harvest index, assimilate partitioning, semi-dwarf habit, earliness, new ideotypes, improved seed quality, and enhanced disease resistance were incorporated in oilseed and legumes.

The effective blend of mutation and recombination breeding at our and other institutes resulted in the release of 50 oilseeds and 60 legume varieties for commercial cultivation in the country (Table 2). Among these, 33 varieties have been released by BARC [4]. These varieties were evolved by incorporating desirable agronomic features like large seed in TG 1, TKG 19A, Somnath (TGS 1), TPG 41 and TLG 45 (groundnut); TAT 10

and TT 6 (pigeonpea); TAP 7, TM 96-2 and TMB 37 (mungbean); TAU 2 (urdbean); semi dwarf habit, high harvest index and better partitioning in TAG 24 (groundnut), TRC 77-4 (cowpea); fresh seed dormancy in TG 22 and TG 26 and drought tolerance in TG 37A (groundnut). Additionally, powdery mildew resistance in TARM 1, TARM 2, TARM 18, TM 96-2; powdery mildew and yellow mosaic resistance in TMB 37 and TJM 3 (mungbean), bacterial pustule resistance in TAMS 38 and multiple pest resistance in TAMS 98-21 (soybean); yellow mosaic virus resistance in TU 94-2 (urdbean) were also introduced in these varieties. Mutant varieties like Aruna of castor, Pusa 408 (Ajay), Pusa-413 (Atul), Pusa-417 (Girnar) of chickpea, Co-4, MaruMoth-1 of mothbean are among the important varieties of economic significance released in India.

Table 1. Spectrum of mutants in oilseeds and grain legumes maintained at BARC, Mumbai, India

Crop	Botanical name	No of mutants	Traits mutated	Mutagen used
Groundnut	<i>Arachis hypogaea</i>	176	Plant height, leaf, pod, seed, disease, oil, salinity tolerance	X rays, gamma rays, EMS, Sodium azide
Soybean	<i>Glycine max</i>	55	Plant height, leaf, protein traits, fatty acid, root nodulation, flower colour, trypsin inhibitor	Gamma rays
Mustard	<i>Brassica juncea</i>	12	Earliness, seed colour, low erucic acid, high oil, leaf type and colour, appressed pods, powdery mildew tolerance	Beta rays, gamma rays
Sunflower	<i>Helianthus annuus</i>	10	Plant height, leaf colour, seed colour, male sterility, high oil, less ray florets, small ray florets	Gamma rays
Mungbean	<i>Vigna radiata</i>	124	Plant height, leaf, branches, flowering, pod, seed, yield, disease resistance, drought tolerance, resistance to pre-harvest sprouting.	X rays, gamma rays, EMS
Blackgram	<i>Vigna mungo</i>	74	Plant height, leaf, branches, flowering, pod, seed, yield, pod shattering resistance, disease resistance	X rays, gamma rays, EMS, Sodium azide.
Pigeonpea	<i>Cajanus cajan</i>	25	Plant height, leaf, branches, flowering, pod, seed, yield, disease resistance	Gamma rays, fast neutrons, EMS
Cowpea	<i>Vigna unguiculata</i>	34	Plant height, leaf, branches, flowering, pod, seed, yield, disease resistance, drought tolerance	X rays, gamma rays, EMS, Sodium azide.

Table 2. Mutant varieties of oilseeds and grain legumes released for commercial cultivation in India

Crop	Botanical name	No of varieties	Mutagen	Traits improved
Groundnut	<i>Arachis hypogaea</i>	28	X-rays, Gamma rays, Sodium azide.	Large seed, early maturity, seed dormancy, high shelling out-turn, high harvest index, drought tolerance
Soybean	<i>Glycine max</i>	7	Gamma rays	Dwarf, earliness, bacterial leaf pustule resistance
Mustard	<i>Brassica juncea</i>	7	X-rays, beta rays, gamma rays	Earliness, large seed, high oil, seed coat colour
Castor	<i>Ricinus communis</i>	4	Fast neutrons, Gamma rays	Early, high yield, drought tolerance
Sesame	<i>Sesamum indicum</i>	3	Gamma rays, EMS	Dwarf, high yield, Cercospora leaf spot (CLS) tolerance
Sunflower	<i>Helianthus annuus</i>	1	Gamma rays	Seed coat colour
Mungbean				
Cowpea	<i>Vigna unguiculata</i>	8	Gamma rays, DMS	Earliness, green fodder, high yield, fodder
Chickpea	<i>Cicer arietinum</i>	7	Gamma rays, Fast neutrons	High yield, profuse branching, Fusarium wilt resistance, robust plant type, salinity tolerance
Blackgram	<i>Vigna mungo</i>	7	Gamma rays, X-rays	Large seed, terminal podding, tolerance to PM and YMV
Pigeonpea	<i>Cajanus cajan</i>	6	X-rays, Fast neutrons, Gamma rays, EMS	High yield, large seed, profuse branching, wilt resistance
Mothbean	<i>Vigna aconitifolia</i>	5	Gamma rays, EMS	High yield, YMV resistance, high protein, high harvest index
Lentil	<i>Lens culinaris</i>	3	Gamma rays	Large seed, protein content
Field bean	<i>Dolichos lablab</i>	2	Gamma rays	Large seed, Photo-insensitiveness
Pea	<i>Pisum sativum</i>	1	E I	Semi-erect, high yield
French bean	<i>Phaseolus vulgaris</i>	1	X-rays	Earliness, YMV resistance
Others		3	Gamma rays	High yield, earliness, large seed

Socio-economic impact of mutant varieties

The majority of the mutant varieties not only benefited the Indian farming community, but are also being used as genetic resource material in national/state breeding programmes. Among the groundnut varieties, TAG 24, TG 26, TG 37A in normal seed class and TKG 19A and TPG 41 in large seed class, became popular among the farming community in India. These are being used as check varieties in the respective national and state varietal trials. As a first step to transfer the benefits of these varieties to the farmers, large-scale breeder seed production programmes were undertaken

by involving several national institutes and state agricultural universities. In the last decade (1998-2008) 1,022 metric tons of breeder seed of these groundnut varieties worth 1.18 million US dollars was produced and supplied to various National and State Seed Corporations, State Agricultural Universities, seed companies, non-governmental organizations, farmers, etc. Based on the feedback received from National Seed Corporation, Pune, they supplied 1,190 metric tons worth 1.3 million US dollars of certified seed of TG varieties to farmers in the last five years. Further, several millions worth trading of groundnut mutant varieties has been taking place in most of the groundnut markets.

Farmers have been realizing the high-yielding ability of groundnut varieties by harvesting record groundnut yields in many parts of the country. By cultivating these mutant varieties, the groundnut productivity in major groundnut states like, Gujarat, Andhra Pradesh, Maharashtra, Karnataka, Orissa and Rajasthan has been almost doubled. Hundreds of farmers were harvesting significantly improved productivity even up to seven tonnes/ha and earning a net profit up to 1,200 US dollars/ha, when recently released groundnut varieties were introduced in these states [6]. Progressive farmers had harvested a record yield of more than 10 tonnes/ha dry pods in TAG 24 and TG 26 varieties by growing them under suitable agro-ecology such as summer environment, balanced nutrition and uninterrupted but controlled irrigation to achieve record yields in groundnut [7]. TAG 24 and TG 26 comprised most of the ideal morpho-physiological traits defined for groundnut. Both the varieties were grown at Field Research Laboratory, Leh at an altitude of 3,505 meters above mean sea level using polythene mulch. This might be the world's first report of groundnut cultivation at that altitude. According to Valls, *et al.* [8], some of the wild *Arachis* species are grown at an altitude of almost 1,600 meters. A drought tolerant variety, TG 37A has rekindled groundnut cultivation in desert areas of Rajasthan state. Existing large seed varieties were with long duration, longer seed dormancy and low productivity. However the recent release of large seed mutant varieties like TPG 41 and TLG 45 benefited many farmers, traders and exporters by virtue of their earliness, moderate seed dormancy and superior productivity.

Looking into advantages of these varieties, several organizations were conducting large-scale field demonstrations and many seed companies have taken up large-scale seed multiplication in order to reach larger pockets of farming community. Directorate of Oilseeds Development, Hyderabad had allocated 9,700 minikits of TG 37A and TPG 41 in major groundnut growing states. Trombay varieties also facilitated farmers to develop newer cropping systems like intercropping groundnut with sweet corn, Bt cotton, sugarcane; polythene mulch technology in groundnut. Our own estimates, breeder seed demand and feedback received from various agencies indicate Trombay groundnut varieties cover around 25% area of groundnut in the country.

In mungbean, BARC has made major break through in developing disease resistant varieties. TARM 1, TARM 2 and TARM 18 were the varieties released for the first time with powdery mildew resistance for southern and central zones of India [9]. TMB-37 has been released for summer season, having early maturity (55-59 days) and yellow mosaic disease resistance that made available an additional area for mungbean cultivation under crop diversity programme. Another mungbean variety TJM 3 is the first variety with multiple disease resistance for powdery mildew, yellow mosaic virus and *Rhizoctonia* root-rot diseases. The recently released mungbean variety TM 96-2 is the first variety for rice fallow cultivation in India, which has powdery mildew resistance and synchronous maturity which are the essential traits for rice fallow cultivation, where nearly four million hectares of rice fallow area is available in India and considered prime area under crop diversity programme. Disease resistance in Trombay mungbean varieties not only enhanced the productivity but also benefited in recovering quality seeds. Based on the breeder production during last few years, Trombay mungbean

varieties are estimated to cover around 10% (300,000ha) of mungbean area in the country.

Urdbean mutant varieties TAU 1 and TU 94-2 are very popular varieties in central and southern zones of India. TAU 1 ranks first for breeder seed demand every year. Based on the feedback received from Maharashtra State Seed Corporation, Akola and National Seed Corporation, Pune, they supplied 21,013 metric tons worth 18.5 million US dollars of certified seed of TAU 1 to farmers. Recently released soybean varieties, TAMS 38 and TAMS 98-21 are becoming popular among the farmers in Vidarbha region of Maharashtra state and are being cultivated on around 150,000 hectares [10].

Conclusion

Our experiences have shown that induced mutation has come to stay as an efficient plant breeding method towards improvement of oilseeds and legumes and development of commercial varieties for our farming community. Evidently, this methodology has benefited the farmers, traders, exporters and end-users and will continue to play a significant role in addressing food and nutritional security. In the present genomic era, induced mutants would be ideal genetic material for future functional genomic studies.

ACKNOWLEDGEMENTS

We thank Dr. S. Banerjee, Director, Bhabha Atomic Research Center and Dr. K.B. Sainis, Director, Biomedical Group for their keen interest and encouragement.

BIBLIOGRAPHY

1. <http://agricoop.nic.in/agristatistics.htm>
2. United States Department Of Agriculture. Oilseeds: World markets and trade. Foreign Agricultural Service, United States Department of Agriculture, Circular Series FOP 6-08 (2008).
3. <http://mvgs.iaea.org/>
4. D'Souza, S.F. Radiation technology for the genetic improvement of crop plants at BARC: an overview.. *IANCAS VI* **4**, 285 (2007).
5. Patil, S.H. Release of X-Ray induced groundnut variety *Tg-1*. *Mutation Breeding Newsl.* **3**, 11 (1974).
6. Murty, G.S.S. *et al.* Impact of new trombay groundnut varieties, *Nuclear India* **41**(03-04), 13 (2007).
7. Kale, D.M. High yields with ideal ideotypes of groundnut varieties tag 24 and tg 26. *International Arachis Newsl.* **22** 13 (2002).
8. Valls J. *et al.* Current status of collection and conservation of south american groundnut germplasm with emphasis on wild species of arachis. *Proc. International Workshop On Cytogenetics Of Arachis*, Icrisat, India, 15 (1985).
9. Reddy, K.S. *et al.* Inheritance Of Powdery Mildew (*Erysiphe Polygoni* DC) Resistance In Mungbean (*Vigna Radiata* L. Wilczek). *Theor. Appl. Genet.* **88**, 945 (1994).
10. Manjaya, J.G. Genetic improvement of soybean through induced mutations. *IANCAS VI* **4**, 319 (2007).

Achievements of Grain Legume Variety Improvement Using Induced Mutation of the IAEA/RAS/5/040 Project in Thailand

S Srisombun^{1*}, P Srinives², C Yathaputanon¹, S Dangpradub¹, A Malipan¹, W Srithongchai¹, B Kumsueb¹, V Tepjun¹, S Ngampongsai¹, A Kornthong¹ & S Impithuksa¹

Abstract

IAEA/RAS/5/040 project aims to form a regional cooperation network of mutation germplasm with emphasis on seed-propagated crops among the Member States in Asia and Pacific commencing in 2002 and ending in 2006. It comprised of two components, the establishment and implementation of mutant multi-location trials and the establishment of mutation germplasm network. Thailand participated with two major grain legume crops, soybean and mungbean, of both components. Significant achievements are summarized. **Soybean mutant multi-location trials:** Two introduced mutants, DT84 from Vietnam and Bangsakong from Korea were well adapted in the upper and lower north of Thailand. DT84 produced similar yield and matured 18 days earlier than Chiang Mai 60 whereas Bangsakong gave 11% greater yield with 12 days earlier than Sukhothai. **Soybean mutants resistant to Soybean Crinkle Leaf:** The disease, caused by virus, is a major disease in Thailand. It is transmitted by whitefly (*Bemisia tabaci*). Seed of a soybean line cm9238-54-1(ST) was irradiated with 200 gray. A number of mutant lines were selected under natural field infections and tested in laboratory. Six mutant lines resistant to the disease were finally selected. **Soybean mutants with high grain protein:** The government policy is to increase grain protein soybean for soy food products. Seeds of three soybean varieties namely Chiang Mai 60, SSRSN19-35-4 and EHP275 were irradiated with 200 gray. Pedigree method of selection was used and grain protein of the mutants was analysed. Thirty two mutant lines were selected. The result of a preliminary trial showed that the lines gave average grain protein of 0.8, 2.0 and 1.0% higher than the original parents of 41.8, 40.3 and 41.9%, respectively. **Soybean mutants with high seed germination and vigor:** Chiang Mai 60, a high yielding soybean variety, has a poor character of seed germination and vigor. Seed of Chiang Mai 60 was irradiated with 100 gray. Pedigree method of selection was used in late generations. Accelerated Aging Test was also used to test the seed vigour of the mutant lines. In dry season trial, eight mutant lines had seed germination of 65-75% compared with the parent of 30%. In rainy season, 12 mutant lines had seed germination of 75-89% whereas the parent had only 41%. **Mungbean mutant multi-location trials:** The highest yielding variety across five trials during 2003-2005 was a Thai mutant, Chai Nat 72. It produced large seed of 70g/ 1,000 seeds which is a desirable trait for Thai and international markets. However, this mutant is susceptible to powdery mildew disease. An introduction from the Philippines, LM19-Native Variety, showed resistant to the disease. It can be utilized for mungbean breeding programme. **Novel mungbean germplasm derived from induced mutation; variegated leaf:** All F₁ plants from the cross between variegated mutant and normal leaf parent showed normal green leaves without reciprocal while the F₂ plants segregated well in a 3 : 1 ratio. The number of F₃ lines showing all green plants, segregating, all variegated plants fitted well with the 1 : 2 : 1 ratio. The variegated

leaf character is controlled by a single recessive gene. **Multiple leaflet:** A mutant with small pentafoolate was crossed with a large heptafoolate mutant to study the inheritance. It was found that their F₂ plants segregated in the ratio of 9,3,4 with tri (N_1-N_2-), penta ($N1-n2n2$) and heptafoolate ($n_1n_1N_2-$ and $n_1n_1n_2n_2$). The n_2 may be closely linked to the gene controlling leaf size as well. There are three AFLP markers linked to number of leaflets per leaf and all of them corresponded to the n_1 locus. The mutants of soybean and mungbean will be utilized for further breeding programme and demonstrated in farmers' field.

Introduction

IAEA/RAS/5/040 project, Enhancement of Genetic Diversity in Food, Pulses and Oil Crops and Establishment of Mutant Germplasm Network, aims to form a regional cooperation network of mutation germplasm with emphasis on seed-propagated crops among the Member States in Asia and Pacific. The project was first approved in 2002 and ended in 2006. It comprised of two components, the establishment and implementation of mutant multi-location trials and the establishment of mutation germplasm network. Thailand participated in two major grain legume crops, soybean (*Glycine max* L. Merrill) and mungbean (*Vigna radiata* L. Wilczek), of both components. Soybean is the most important grain legume in Thailand. The annual planted area during the past five years of 2002-2006 was 156,000ha with an annual production of about 232,000t [1], only 15% of the country's demand. Presently, 70% of the domestic demand is used for vegetable oil extraction and 10% is used for food products. Thai government policy is to increase the national productivity and improve grain quality of high protein for domestic consumption and for exports of soy food products. Mungbean is the second most important grain legume, occupying an annual planted area about 210,000ha during 2002-2006 with an annual production of 151,000t [1]. It can be cultivated three seasons of the year, the late rainy season commencing between late August and September is strongly recommended. Most of the annual mungbean production is used for bean sprouts. Therefore, germination and sprout quality are very important. Then bold seed is a preferred trait for domestic use and exports. Significant achievements of the research project are summarized.

Soybean mutant multi-location trials

The objective of this study was to evaluate grain yield and adaptability of introduced soybean mutants and their parents. The experiment was conducted at Chiang Mai Field Crops Research Center (FCRC) (18°14'N lat., 99°30'E lon., 316 m alt.) and Sukhothai Plant Production and Technical Service Center (PPTSC) (17°10'N lat., 99°52'E lon., 54 m alt.), the representative areas of the main soybean production in northern Thailand. RCB design was used with three replicates. A total number of 15 varieties included three mutants from Indonesia (GH-7, M-220, I-209), one parent and two mutants from Korea (Kumkangdaerip, KEX-2, Bangsakong), two mutants from Vietnam (M103, DT84), two parents and two mutants from China (HC18, HC18M, AJMD, AJMDM), and a parent (Chiang Mai 60), a mutant (CM60-10KR-71-PS-21) and a

¹ Department of Agriculture, Bangkok, Thailand

² Faculty of Agriculture, Kasetsart University, Kamphaeng Saen, Nakorn Pathom, Thailand

* Corresponding author. ksssb@doa.go.th

local check (Sukhothai 2) from Thailand. Plant population density was about 30-40 plants/m² with 50cm between rows, 20cm between hills and three to four plants per hill. Seed was inoculated with *Bradyrhizobium* at Chiang Mai FCRC. Fertilizer grade of 12-24-12 at a rate of 156 kg/ha was applied during 15-25 days after sowing (DAS). Pre-emergence herbicide was sprayed plus hand weedings prior to flowering. Insecticides were sprayed to control key insect pests, beanfly, whitefly, pod borers and bugs. Soybean was planted during either rainy or dry seasons. The amounts of rainfall during the crop duration in rainy season at Chiang Mai FCRC were 488 mm, 649 mm and 1,007 mm in 2003, 2004 and 2005 and at Sukhothai PPTSC were 546 mm and 672 mm in 2004 and 2005, respectively. In dry season 2004 and 2005, the plots were irrigated by flood-furrow system five times at Chiang Mai FCRC. In dry season 2005 at Sukhothai PPTSC, the plots were sprinkled six times with a total amount of 300 mm of water. Plants were harvested at 95% of pods reach their maturity.

Table 1. Soybean traits of exotic mutants compared with Thai varieties

Area/ variety	Grain yield (t/ha)	Days to maturity ²	100 seed wt. (g)
Upper north (5 trials, 2003-2005)			
DT84	1.74	83	15.2
Chiang Mai 60 ¹	1.69	101	13.7
Lower north (2 trials, 2005)			
Bangsakong	2.08	82	15.0
Sukhothai 2 ¹	1.89	94	14.5

¹ Thai check varieties
² days after sowing

At Chiang Mai FCRC, Chiang Mai 60, the most popular variety among Thai farmers in the upper north and central region, gave an average grain yield of 1.69 t/ha (Table 1), compared to the national average yield of 1.53 t/ha during 2003-2005 [1]. In general, the later days to maturity of the soybean, the greater the yield produced [2]. A mutant DT84 from Vietnam matured 18 days earlier than that of Chiang Mai 60, 101 DAS. However, it gave average grain yield of 1.74 t/ha, similar to that of Chiang Mai 60 (Table 1). In addition, DT84 had 11% larger seed size than Chiang Mai 60, 13.7 g/100 seeds. Desirable soybean grain of the Thai market for food products should have similar or larger seed size than Chiang Mai 60. DT84 is suitable to be grown in the rice-based cropping system and it is very promising for farmers in the upper northern area of the country [3].

At Sukhothai PPTSC, no introduction gave better yield than Thai variety Sukhothai 2, except a mutant Bangsakong from Korea produced the highest grain yield of 2.08 t/ha averaged from the 2005 trials, 11% higher than that of Sukhothai 2 (Table 1). Bangsakong matured 12 days earlier than Sukhothai 2, 94 DAS (Table 1). It produced similar seed size with Sukhothai 2, 14.5 g/100 seeds. Bangsakong is also a promising mutant for farmers grown in rice-based cropping system in the lower north of Thailand [3].

During 2006-2007, mutant varieties DT84 and Bangsakong were improved by the method of mass selection at Chiang Mai FCRC. The seed of two varieties was also multiplied for further test of their performance in farmers' fields prior to released.

Soybean mutants resistant to Soybean Crinkle Leaf

Soybean Crinkle Leaf (SCL) disease, caused by a virus, is a major disease in Thailand. It was first found in Thailand in 1979 [4]. It is transmitted by whitefly (*Bemisia tabaci*). Since 1998, the disease has been found in most main soybean-producing areas, in all growing seasons, and currently is a major constraint to soybean production [5]. Grain yield of soybean

can not be produced if the disease infects at the early stage of growth to flowering. Several insecticides are recommended to control whitefly. However, it is costly and not environmentally friendly. cm9238-54-1(ST) is a soybean promising line, it gave 5-10% higher grain yield than cv Chiang Mai 60. But the line is susceptible to SCL disease. Then seed of the line cm9238-54-1(ST) was irradiated with 200 gray. Pedigree method of selection was used from M₂-M₄. A number of mutant lines were selected under natural field infections at Lop Buri PPTSC and tested in laboratory at the Department of Agriculture, Bangkok. In laboratory, virus-free whitefly was transferred to infected soybean plants for a day. Then the disease agent was transmitted by releasing 30-40 whiteflies per plant for two days on M₄ seedlings lines. Thirty plants were used per line. The plants showing SCL symptom were observed at 40 days after transmission. Yield trials were conducted in 2005 and 2006 at Lop Buri PPTSC. In the 2005 trials, no insecticide was sprayed from emergence to flowering for free whitefly infestations. Later it was sprayed three times after flowering till full seed development to control pod borers and bugs. In the 2006 trial, insecticide was sprayed nine times from emergence to full seed filling stage to completely control whitefly and other insect pests.

Six mutant lines resistant to the disease were finally selected. The disease reaction under the laboratory test is shown in Table 2 compared with the original parent and two check cultivars. The results from the 2005 trials, the six lines gave average grain yield of 2.24-2.33 t/ha, 74-81% higher than that of the original parent under natural disease infections (Table 2). The yield reduction of the parent and check cultivars was due to the susceptibility to the disease leading to a decrease in the number of seeds per pod. Under no SCL disease symptom in the 2006 trial, the original parent gave the highest yield of 3.76 t/ha resulted from the highest number of pods per plant. However, the six mutants produced higher grain yield than the check cultivars. The mutant lines are being tested for their adaptability in farmers' fields.

Table 2. Grain yield and disease reaction of soybean mutant lines resistant to SCL disease in 2005 and grain yield under no disease symptom in 2006, Lop Buri PPTSC, Thailand

Mutant line/variety	Grain yield (t/ha)			SCL disease reaction
	dry season 2005	rainy season 2005	mean	
1-4	1.95 abc	2.54 ab	2.24	3.32 b R
16-42	1.81 bc	2.66 a	2.24	3.28 b MR
18-46	2.06 ab	2.59 a	2.33	2.80 c R
19-49	2.02 ab	2.58 a	2.30	3.38 b MR
20-50	2.14 a	2.36 b	2.25	3.26 b R
30-1	2.04 ab	2.61 a	2.32	3.31 b R
CM9238-54-1(ST)	1.76 c	0.82 d	1.29	3.76 a S
Chiang Mai 6 ¹	0.52 d	0.92 d	0.72	2.24 d VS
Sukhothai ¹	0.64 c	1.21 c	0.92	2.49 d S
Mean	1.66	2.03	1.84	3.09 -
CV (%)	7.6	8.1	7.9	6.0 -
Sowing dates	10 Jan	29 Jul	-	6 Jul -

Means followed by a common letter are not significantly different at 5% level by DMRT. Grain yield at 12% moisture, Season 2005 x Variety interaction is significant. Laboratory test of SCL disease, R = resistant, all plants showed no symptom; MR = moderately resistant, 1-10% of plants showed symptom; S = susceptible, 11-50% of plants showed symptom; VS = very susceptible, >50% of plants showed symptom. ¹ = check varieties.

Soybean mutants with high grain protein

The most popular soybean variety of Thai farmers is Chiang Mai 60. It gives about 36-38% of grain protein depending on locations and seasons.

The government policy is to increase grain protein of soybean for soy food products. Then soybean variety improvement to increase grain protein content was initiated. The seed of three soybean varieties namely Chiang Mai 60, SSRSN19-35-4 and EHP275 were irradiated with 200 gray. Pedigree method of selection was used at Nakhon Ratchasima FCRC and grain protein of the mutants was analyzed in laboratory at the Department of Agriculture, Bangkok [6].

A number of 32 mutant lines were selected. The result of a preliminary trial at Nakhon Ratchasima FCRC in 2007 showed that the lines gave average grain protein of 0.8, 2.0 and 1.0% higher than the original parents of 41.8, 40.3 and 41.9%, respectively [7]. Then it is possible to enhance grain protein percentage with similar or higher yield in the soybean varieties using induced mutation. The promising mutant lines will be further tested for their protein yield in farmer fields.

Soybean mutants with high seed germination and vigor

Chiang Mai 60 is a high yielding soybean variety in Thailand. However, it has a poor character of seed germination and vigor. Then induced mutation was used to improve seed quality of the variety, seed of Chiang Mai 60 was irradiated with 100 gray. Pedigree method of selection was used in late generations of M_4 - M_6 at Chiang Mai FCRC. Accelerated Aging Test was also used to test the seed vigor of the mutant lines.

A total number of 23 mutant lines were finally selected. In preliminary trials conducted in dry season 2006, eight mutant lines had seed germination of 65-80% compared with the original parent of 30%, whereas in rainy season 2006, 12 mutant lines had seed germination of 75-89%, and the parent gave only 41% [8]. The selected mutant lines are being tested for their yield in standard trials.

Mungbean mutant multi-location trials

The objective of this study was to evaluate grain yield and adaptability of introduced mungbean mutants and their parents. A total number of 18 mungbean accessions including introduced mutants, their parents and three Thai check varieties were tested for their yield and adaptability in the central region of the Kingdom, Chai Nat FCRC (15°15'N lat., 100°15'E lon., 16m alt.) and Kasetsart University, Kamphaeng Saen Campus (14°01'N lat., 99°58'E lon., 5 m alt.). Details of experiment carried out are shown in [9].

The highest yielding variety across five trials during 2003-2005 was a Thai mutant, Chai Nat 72. It produced large seed of 70 g per 1,000 seeds which is a desirable trait for Thai and international markets. However, this mutant is susceptible to powdery mildew disease. An introduction from the Philippines, LM19-Native Variety, showed resistance to the disease. It can be utilized for further mungbean breeding programme in Thailand [9].

Novel mungbean germplasm derived from induced mutation

Variegated leaf

Variegated mutant was obtained from Gamma-rays irradiation at a rate of 500 gray. All F_1 plants from the cross between the variegated mutant and the normal leaf parent showed normal green leaves without reciprocal, while the F_2 plants segregated well in a 3 : 1 ratio. The number of F_3 lines showing all green plants, segregating, all variegated plants fitted well with the 1 : 2 : 1 ratio. Thus it can be inferred that the variegated leaf character is controlled by a single recessive nuclear-encoded gene. We propose *var1* as the gene symbol [10].

Multiple leaflet

Two new multiple leaflet mungbean mutants were also obtained from Gamma-rays irradiation. A mutant with small pentafofoliate was crossed with a large heptafofoliate mutant to study the inheritance at Kasetsart University, Kamphaeng Saen Campus. AFLP markers were also screened

to make a partial linkage map around the genes controlling multifoliate leaflets. The number of F_2 plants was tested against a 3, 1 ratio for segregation in a single locus and 9 : 3 : 3 : 1 for 2 independent loci using the Chi-square goodness of fit test. The heterogeneity among the F_2 families was also tested accordingly. Crossing between 7 large leaflet (L-7) and 5 small leaflet (S-5) mungbean mutants resulted in the normal-trifoliate (N) F_1 . The F_2 can be classified into number of leaflet per leaf and leaflet size with large-trifoliate (N_1-N_2 -), small-pentafofoliate ($N_1-n_2n_2$), large-heptafofoliate ($n_1n_1N_2$ -), and small-heptafofoliate ($n_1n_1n_2n_2$) at the dihybrid ratio of 9 : 3 : 3 : 1. The finding is thus evident that leaflet number was controlled by n_1 locus and leaflet size was controlled by n_2 locus of genes, respectively. However, all three AFLP markers associated with leaflet number in this study corresponded to n_1 locus only. The n_2 locus can have a pleiotropic effect upon the leaflet size such that the N_2 allele controls large leaflet size as well. Another hypothesis is that the n_2 locus might be closely linked with the *s* locus so that there was no progenies with large pentafofoliate leaflet (hypothetically carrying $N_1-n_2n_2S$ -genotype). [10]

BIBLIOGRAPHY

- Office Of Agricultural Economics. Agricultural Statistics Of Thailand 2006. Ministry Of Agriculture And Co-Operatives, Bangkok, Thailand (2007).
- Srisombun S. *et al.* The potential productivity of late maturity varieties of soybeans in Thailand. (Eds, Janprasert, W. *et al.*) In: Proceedings Of The National Soybean Research Conference VI. September 3-6, 1996. Chiang Mai, Thailand 97-105 (1997).
- Dangpradub, S. *et al.* Soybean mutants regional trials. *Thai Agricultural Research Journal* **26**, 2-8 (2008).
- Iwaki M. *et al.* Soybean crinkle leaf, new whitefly-borne disease of soybean. *Plant Disease* **67**, 546-548 (1983).
- Srisombun, S. *et al.* Soybean mutants resistant to soybean crinkle leaf disease. IAEA/RCA Project Final Review Meeting On Ras/5/040 Project. Jan 15-19, 2007. Mumbai, India (2007).
- Kumsueb, B. *et al.* Selection of high protein soybean mutants. Proceedings Of The First National Grain Legume Research Conference, Aug. 28-30, 2006. Chiang Rai, Thailand (2007).
- Yathaputanon, C. *et al.* Protein content in high protein soybean mutants in Thailand. International Symposium On Induced Mutation In Plants. Aug. 12-25, 2008. Vienna, Austria (In This Proceedings) (2008).
- Tejrun, V. *et al.* Soybean variety improvement for seed germination and vigor in cv Chiang Mai 60 Using Gamma Irradiation. The 2008 Chiang Mai Field Crops Research Center Annual Meeting (2008).
- Ngampongsai, S. *et al.* Current status of mungbean and the use of mutation breeding in Thailand. International Symposium On Induced Mutation In Plants. Aug. 12-25, 2008. Vienna, Austria (In This Proceedings) (2008).
- Srinives, P. *et al.* Novel mungbean germplasm derived from induced mutation. IAEA/RCA Project Final Review Meeting On Ras/5/040 Project. Jan 15-19, 2007. Mumbai, India (2007).

Development of Mutant Varieties of Crop Plants at NIAB and the Impact on Agricultural Production in Pakistan

M A Haq

Abstract

The Nuclear Institute for Agriculture and Biology is the prime institute of Pakistan Atomic Energy Commission in the agricultural sector. It began to function in 1969. The main objective of the institute is to conduct research in agricultural and biological problems, especially in those areas where nuclear techniques have an edge over conventional methods. The institute has been conducting research and development work related to crop improvement through mutation breeding. Mutation breeding involves the use of induced beneficial changes for practical plant breeding purposes both directly as well as indirectly. The main objectives have been to confer specific changes such as improvement of plant architecture, earliness in maturity, resistance against diseases and pests, and improved physiological characters, i.e. heat tolerance, cold tolerance, uniform maturity, photoperiod insensitivity etc., in the native well adapted crop varieties/exotic lines to make them more productive. The use of induced mutations for crop improvement has led to the development of 24 improved varieties of different crops at NIAB which clearly indicates the potential of this technique. In addition, a wealth of genetic variability has been developed for use in the cross breeding programmes and a few varieties of cotton and chickpea have been developed in Pakistan by using induced mutants as one of the parents. These improved crop varieties in Pakistan have played a significant role in increasing agricultural production with positive impact on the economy of the country. The estimated additional income accounted by the selected varieties of NIAB was 1.744 billion US dollars up to 2005.

Introduction

Nuclear Institute for Agriculture and Biology (NIAB), Faisalabad is a prime agricultural institute of Pakistan Atomic Energy Commission. NIAB is one of the four agricultural research centers of the Commission and it now constitutes an important element in the infra structure of scientific research in the country. NIAB has made an indelible mark in the field of agricultural research in the country. Its output in terms of both basic and applied research has more than justified the modest expenditure on its establishment and operation. The main objective of NIAB is to promote peaceful applications of atomic energy in the biological research in general and agricultural research in particular. It was established to demonstrate how modern and advanced nuclear techniques could contribute to major improvement in agricultural output both in quantity and quality, and thereby bringing the economic benefits of atomic energy to the people of Pakistan, 80% of whom earn their livelihood through agriculture.

By a very careful selection of research projects, NIAB has concentrated on devising methods and evolving crop varieties for increasing agricultural productivity and on conservation of inputs and produce. It has been able to make a significant contribution not only in agricultural

research but also in understanding some relevant basic biological processes. It has clearly established a role for radiation induced mutations in crop improvement and has succeeded in evolving better germplasm of selected key crops. Work on improvement of cotton, rice, and grain legumes is in progress through the use of mutation breeding, conventional breeding and wide hybridization techniques. The prime strategy in mutation-based plant breeding has been to upgrade the well-adapted varieties by altering one or two major traits. These include characters such as plant height, maturity, seed shattering, and disease resistance, which contribute to increased yield and quality traits [1]. In several mutation-derived varieties, the changed traits have resulted in synergistic effect on increasing the yield and quality of the crop, improving agronomic inputs, crop rotation and consumer acceptance [1]. The breeding efforts have resulted in the development of 24 improved varieties of crop, including six varieties of cotton, two of rice, four of chickpea, 10 of mungbean and two of lentil. In addition, many mutants of these crops are at advanced stages of testing.

In the present paper the development of induced mutants and mutation-derived varieties at NIAB is discussed and their economic impact presented.

Materials and Methods

The research work at NIAB was started during 1969. In crop improvement programme the self-pollinated crops i.e., cotton, rice, chickpea, mungbean and lentil were selected. Mutation breeding involves the use of induced beneficial changes for practical plant breeding purposes, both directly as well as indirectly coupled with the conventional hybridization in some cases. The main objectives have been to confer specific changes such as improvement of plant architecture, earliness in maturity, resistance against diseases and pests, and improved physiological characters i.e. heat tolerance, cold tolerance, uniform maturity, photoperiod insensitivity etc., in the native well adapted crop varieties/exotic lines to make them more productive. The strategy in mutation breeding was to upgrade the well-adapted varieties by altering one or two major traits. Gamma radiation treatments and different EMS concentrations have been tried depending upon radio sensitivity tests. As a result of these breeding efforts different varieties of these five mandate crops have been developed at NIAB.

Results and Discussion

The efforts at NIAB have resulted in evolving 24 improved varieties of cotton, rice, chickpea, mungbean and lentil (**Table 1**). These self-pollinated crops were selected because of little variability available in them to improvement through conventional techniques. The area and additional income from selected varieties of NIAB during 2004-05 is given in **Table 2**. Some of the salient results have been described here.

Cotton

The mutation breeding programme in cotton was initiated in 1970 to create genetic variability for development of early maturing, high yield-

Nuclear Institute for Agriculture and Biology (NIAB), P.O. Box 128, Jhang road, Faisalabad, 38000, Pakistan.

Email: niabdir@fsd.comsats.net.pk

ing varieties and germplasm having resistance to diseases, insects and other stresses with better fiber qualities.

Crosses were made between a local (AC 134) and an exotic variety (Delta pine) followed by the irradiation of F_1 hybrid. From the selections, line NIAB 78 had the desired fiber quality and gave the highest yield. It was released as a commercial variety in 1983. It has proved to be adapted to the different agroclimatic areas of the country. Since its introduction cotton, production registered a quantum jump in Pakistan [2]. The cumulative additional income to the farmers because of this variety was 612.4 million US dollars from 1882-83 to 2005 (Table 2). The insect resistant and high yielding variety NIAB 86 was evolved as the result of a cross between a pest resistant mutant H 1-9-6-2 and a long staple mutant SP 16. It was released as commercial variety in 1990. Crossing of mutant line with an exotic germplasm having nectariless leaf resulted in the development of NIAB 26 which was released in 1992.

The onset of CLCuV disease in early nineties resulted in a sharp decline in cotton production inflicting severe set back to our economy. This necessitated incorporation and/or induction of CLCuV resistance into the adapted cotton cultivars. Besides induction of mutations, various sources of CLCuV disease resistance tried to achieve the desired objectives. A nectariless line that had tolerance to heat and leaf curl virus disease was released as a commercial variety 'NIAB Karishma' in 1996. NIAB Karishma brought farmers US \$ 294.4 million additional income since 1997-98 to 2005. Moreover, a number of elite mutants viz., NIAB-92 (Stoneville), NIAB 313/12 (*G. barbadense* x *G. hirsutum*), Hi (PIMA x *G. hirsutum*), St-3, Hi-9, M 555, Mutant Chandni and Mutant 39 have been developed with specific characteristics of economic value. These mutants proved an asset as a number of varieties viz. Shaheen, NIAB-86, CIM-109, SLS-1 and CRIS-9 have been evolved by various organizations in the country by employing these mutants in their breeding programme [3].

Mutant NIAB-999 has been derived from H1 x LRA 5166 cross combination followed by 300Gy of F_1 seed. It has heat resistance, early maturity, high yield and wider adaptability. Its earliness makes it suitable to fit in wheat-cotton-wheat rotation system. It was approved for general cultivation during 2003. Another mutant strain NIAB-111 has been derived from the intraspecific hybridization, NIAB-313/12 (ISM) x CIM-1100 followed by F_1 seed treatment with 300Gy. It is a high yielding, CLCuV resistant, superior fiber and heat tolerant variety of cotton approved for general cultivation during 2004.

Rice

Rice is the third largest crop after wheat and cotton in Pakistan. It is high value cash crop and is also major export item. It accounts for 5.7% in value added in agriculture and 1.2% in GDP. It is grown on an area of 2,621 thousand ha producing 5,547 thousand tons with paddy yield of 2116 kg ha⁻¹. Pakistan grows enough high quality rice to meet both domestic and export demands. Different varieties of rice are grown in Pakistan, viz. Super Basmati, Basmati 385, Irri-6, Niab-Irri-9, KS-282 and KS 133, etc. Pakistan is primarily known for its aromatic rice. Two types of rice dominate the market: Basmati, which is mainly grown in the Punjab province and Irri types, which is mainly grown in Punjab and Sindh provinces. Genetic diversity for early maturity, disease tolerance, semi-dwarfism etc. needs to evolve in Basmati rice for its sustainable production. The IRRI varieties introduced in Pakistan have higher yields than the traditional cultivars but their grain quality does not meet the consumers' demand.

A research programme was initiated at NIAB for creation of genetic variability in Basmati and IRRI background through induced mutations and hybridization. The objectives for Basmati improvement were to evolve early maturing, short statured, high-yielding, good quality and salt tolerant lines while grain quality improvements were desired in the IRRI varieties.

Earlier research efforts resulted in the release of an early maturing mutant Kashmir Basmati (derivative of Basmati 370) as a variety for general cultivation in Azad Kashmir during 1977. A number of short statured mutants were also developed [4,5]. Several semi dwarf mutants were selected from basmati varieties and used in genetic studies [6]. Studies to identify new gene sources of early maturity and dwarfism in the adapted Basmati background revealed that early maturity gene in Kashmir Basmati was non allelic to that in variety C-622. Similarly, the gene for dwarfness in mutant DM 107-4 was found non allelic to that in IR-6 [7]. The information thus obtained was utilized in the development of short statured and early maturing varieties of Basmati rice. Among other mutants, NIAB-6 proved to be salt-tolerant producing high yields at salinity levels of ECe 10 dSm⁻¹. NIAB-6 was approved and designated as "Niab-Irri-9" by the government of Punjab during 1999 for general cultivation. Niab-Irri-9 is a non-aromatic, fine grain, salt tolerant and high yielding mutant line (derived from IR-6). This variety occupies about 64% area under non-aromatic rice in Punjab and gave 2.43 million US dollars additional income to the farmers during 2004-05 and 16.18 million US dollars from 1999-2000 to 2005 (Table 2). Some of extra long grain mutants namely EL-30-2-1, EL-30-2-2 in Basmati Pak background having grain length and width of 10 and 1.60 mm respectively and elongation of more than 18 mm are being utilized in cross breeding and a number of recombinants with desired traits have been selected.

Chickpea

Pakistan ranks second in terms of acreage and third in terms of chickpea production. With protein content nearly twice that of cereals, it is a cheap source of quality protein that complements the proteins in cereals thus enhancing the nutritional value of cereal-dominated diet. Chickpea is of two main types, desi and kabuli. Both are botanically similar, but there are strong consumer preferences in one or the other. The contribution of kabuli to the production is 15%, which is declining due to its greater susceptibility to various stresses than desi type. As a result the price of kabuli remains high and we have to spend more than 250 million rupees annually on its import. In Pakistan, the crop is grown on more than 1.0 million hectares with an annual production of 0.58 million tones. Low yield is due to low yield potential of land races and poor crop management. *Ascochyta* blight and *Fusarium* wilt diseases are also major constraints to its production. To develop high-yielding, widely adapted and disease resistant varieties, a programme at NIAB was initiated in 1974, where an integrated approach to chickpea improvement is being pursued. A high priority has been given to screening of segregating material and advanced mutants for *Ascochyta* blight and *Fusarium* wilt resistance. Yield testing of new mutants/varieties is conducted in cooperation with various national and international agencies.

Every year at NIAB, seeds of at least two chickpea genotypes (one desi and one kabuli) are treated with mutagens for the creation of genetic variability. During last 34 years, 29 genotypes/ varieties have been treated with at least two doses of gamma irradiation and ethyl methane sulphate (EMS). Mutation breeding requires an effective mutagen treatment and an efficient way of selection [8]. For gamma radiation treatments, dose range of 150 to 750Gy and for EMS treatments, concentrations ranging from 0.1-0.5% have been tried depending upon radio sensitivity tests.

An achievement of these efforts has been the evolution and release of an *Ascochyta* blight resistant and high-yielding variety of chickpea namely cm 72 in 1983. Air-dried seed of blight susceptible but high yielding genotype 6153 were exposed to gamma radiation treatment of 150Gy in 1974; selections made in M_2 - M_3 generations [9]. This mutant cultivar covered more than 40% chickpea growing area in the country in 1987 and has helped greatly to stabilize chickpea production.

As a result of efforts to induce blight resistance in different genetic backgrounds other than 6153 to produce alternate sources of resistance,

a blight resistant and wilt tolerant mutant cm 88 was derived from variety C 727 and released in 1994. Air-dried seed of C 727 were exposed to gamma radiation treatment of 100Gy in 1977-78. The M₂ was screened in the *Ascochyta* Blight Nursery (ABN) in 1978-79 and resistant plants were selected. The resistant plant progenies were further evaluated in the ABN and also evaluated for various morpho-agronomic traits and yielding ability in Preliminary, Cooperative and National Yield Trials in the successive generations. cm 88 proved to be higher yielding and resistant to *Ascochyta* blight and *Fusarium* wilt [10].

K850 is a bold seeded high yielding variety but it is highly susceptible to *Ascochyta* blight. Efforts were therefore made to rectify this through induced mutation. Seeds of this variety were treated with different doses of Gamma-rays and screening for disease resistance in M₂ generation was done in the nursery by artificially creating disease epiphytotic conditions. Selected progenies of resistant M₂ plants were studied for agronomic characteristics and samples of each line were tested for disease resistance. Based on yield potential, bold seed and *Ascochyta* blight and *Fusarium* wilt resistance; cm 31-1/85 was selected and released as a variety cm-98 in 1998 [11]. The release of this variety meets the consumer's demand/ preference for large seed size variety.

Large scale cultivation of these high yielding and disease resistant varieties has helped greatly to stabilize/increase chickpea production in the country and since their release no serious blight epidemic has been reported [11].

Many good sources of *Ascochyta* blight resistance are available in the exotic germplasm especially from ICARDA. However, they are not well adapted in Pakistan and are badly affected by *Fusarium* wilt. The breeding work on kabuli chickpea has resulted in the release of a high-yielding and disease-resistant variety cm2000 in 2000. This variety has been evolved by creating genetic variability in an exotic variety ILC 195 using 150Gy gamma radiation [12]. It is recommended for cultivation in rainfed and irrigated areas of Punjab. Large-scale cultivation of cm 2000 greatly helped in increasing the kabuli chickpea production in the country.

The current area covered by these mutant cultivars is more than 30% of the total area under chickpea. The additional income to the farmers has been estimated at 11.76 million US dollars during 2004-05 and 752.3 million US dollars from 1997-98 to 2005 (Table. 2).

To induce resistance against wilt disease in susceptible kabuli variety (Pb.1), seeds were treated with different doses/concentrations of physical and chemical mutagens and screening for wilt resistance in M₂ generation was done in the natural wilt sick field. From M₂ segregating populations and subsequent generations cm94/99 was selected and evaluated in various yield trials. This mutant exhibited 38.0 and 66.8% increased yield than check variety cm2000 in Chickpea National Uniform Yield Trials (CNUYT)- kabuli during the years 2003-04 and 2004-05, respectively. The candidate line cm94/99 was cleared by the technical experts in the spot examination during March, 2008 and will be discussed in the meeting of Punjab seed council for approval as a commercial variety for general cultivation.

As a result of mutation breeding efforts, an excellent asset of genetic variability has been created in both types (desi and kabuli) of chickpea through induced mutations. More than 600 disease-resistant (*Ascochyta* blight, *Fusarium* wilt) and morphological mutants affecting most parts, such as leaf, flower, plant height, plant type, pods, maturity and seed were selected from M₂ and subsequent generations. Most of the selected mutants have been confirmed for mutational traits and evaluated for various morpho-agronomic traits. The true breeding mutants have been added to the gene pool being maintained at NIAB, Faisalabad and PGRI, Islamabad. This variability is supplied as germplasm to various national and international organizations for use in breeding programmes. Interspecific hybridization between different cultivated varieties and annual wild *Cicer* species has provided useful genetic variability.

Mungbean

The work on mungbean improvement was initiated at NIAB in 1970s. The main objective of the mungbean improvement programme was to create genetic variability through induced mutations and hybridization, to evolve high-yielding and disease-resistant varieties having compact plant type, earliness and uniform maturity. Since then 10 high-yielding, early-maturing and disease-resistant varieties have been released. Of these, five varieties viz. NM 28, NM 13-1, NM 19-19, NM 20-21, and NM 121-25 are derivatives of small seeded, local adapted germplasm whereas the large seeded varieties viz. NM 51, NM 54 resulted from hybridization between exotic and local germplasm [3]. The most popular bold seeded variety NM 92 was released in 1996 and a medium seeded variety NM 98, having shiny seed coat color was released in 1998 [13]. During 2006, another bold seeded variety NIAB Mung 2006, a derivative of an exotic AVRDC accession VC 1560D and an adapted variety NM-92 having high seed yield, purple hypocotyls and stem, synchronous pod maturity, higher number of pods per plant, and resistance to *Cercospora* Leaf Spot (CLS) and Mungbean Yellow Mosaic Virus (MYMV) diseases has been approved by the Provincial Seed Council for growing in the irrigated tract of the Punjab province. Purple hypocotyle and stem colour can be used as morphological markers for varietal identification. Varieties NM 92, NM 98 and NM 2006 have been under cultivation on more than 70% of mungbean acreage in Punjab province. NM 92 and NM 98 was grown on an area of 181 thousand hectares and brought 7.56 million US dollars addition income to farmers in 2004-05 and 68.8 million US dollars from 1996-97 to 2005 (Table 2).

Lentil

The improvement work on lentil through induced mutations and conventional breeding techniques was started in 1986. Research efforts have culminated in the development of two lentil varieties. NIAB Masoor 2002, a high-yielding, disease-resistant and early-maturing variety was released for cotton based cropping pattern. NIAB Masoor 2002 matures one month earlier than Masoor 93, and farmers of cotton area can grow cotton easily after the harvest of this variety. It is the result of hybridization between an exotic Argentinian variety Precoz and a local cultivar Masoor 85. Punjab Seed Council has approved this variety in the year 2002 for cotton growing areas of the Punjab province.

Another high-yielding and disease-resistant variety, NIAB Masoor 2006, has been developed through induced mutation (ILL 2580 exposed to 200Gy) and was approved by Punjab Seed Council for traditional lentil growing areas of the Punjab province during 2006.

The discovery that ionizing radiations and chemical mutagens can cause genetic changes and modify linkages offered promise to the improvement of crop plants. Mutation breeding involves the use of induced beneficial changes for practical plant breeding purpose both directly as well as indirectly. Mutation breeding can be used to complement and supplement existing germplasm resources [14]. The prime strategy in mutation-based plant breeding has been to upgrade the well-adapted varieties by altering one or two major traits and these include characters such as plant height, maturity, seed shattering, and disease resistance, which contribute to increased yield and quality traits [1]. Induced mutations have been used in the improvement of major crops such as wheat, rice, barley, cotton, peanuts, beans, which are seed propagated [15]. More than 1,800 cultivars obtained either as direct mutants or derived from their crosses have been released worldwide in 50 countries [16]. Among the mutant varieties released, cereals are at the top followed by legumes, demonstrating the economics of the mutation breeding techniques.

In Pakistan, the use of mutation breeding technique for the improvement of crops has led to the development of 59 cultivars of cotton, rice, wheat, chickpea, mungbean and rapeseed which have played a significant role in increasing crop production in the country.

Conclusion

The use of induced mutations for crop improvement has led to the development of 24 improved varieties of different crops at NIAB which clearly indicates the potential of this technique. In addition, a wealth of genetic variability has been developed for use in the cross breeding programmes and a few varieties of cotton and chickpea have been developed in Pakistan by using induced mutants as one of the parents. These improved crops varieties in Pakistan have played significant role in increasing agricultural production with positive impact on the economy of the country.

BIBLIOGRAPHY

- Ahloowalia, B.S., Maluszynski, M., Nichterlein, K. Global impact of mutation-derived varieties. *Euphytica*, **135**,187-204 (2004).
- Iqbal, R.M.S., Chaudhry, M.B., Aslam, M., Bandesha, A.A. Economic and agricultural impact of mutation breeding in cotton in Pakistan - a review. In: Plant Mutation Breeding For Crop Improvement, Vienna, IAEA, 187-201 (1991).
- Nuclear Institute for Agriculture and Biology. Twenty years of Niab. 4th five-year report. Faisalabad, Pakistan, Niab, 203 (1992).
- Nuclear Institute for Agriculture and Biology. Five years of Niab. 1st five-year report. Faisalabad, Pakistan, Niab, 160 (1977).
- Nuclear Institute for Agriculture and Biology. Ten years of Niab. 2nd five-year report. Faisalabad, Pakistan, Niab, 166 (1982).
- Awan, M.A., Cheema, A.A., Tahir, G.R. Induced mutations for genetic analysis in rice. In: Rice Genetics, Irri, Philippines, 697-705 (1986).
- Nuclear Institute for Agriculture and Biology. Fifteen years of Niab. 3rd five-year report. Faisalabad, Pakistan, Niab, 202 (1987).
- Micke, A. Mutation breeding of grain legumes. *Euphytica* **152** 81-85 (1993).
- Haq, M.A., Sadiq, M., Hassan, M. Induction of ascochyta blight resistance in chickpea through induced mutations. In: Proc. 4th FAO/IAEA Res. Cord. Meet. On The Use Of Induced Mutations For Improvement Of Grain Legume Production, Faisalabad. 3-7 March, (1984).
- Haq, M.A., Hassan, M., Sadiq, M. 'Cm 88' - a multiple disease resistant chickpea mutant variety. IAEA, Vienna. *Mutation Breeding Newsletter*, **45**, 5-6 (2001).
- Haq, M.A., Sadiq, M., Hassan M., 'Cm 98' (Cm 31-1/85) - a very high yielding, disease resistant mutant variety of chickpea. *International Chickpea And Pigeonpea Newsletter* **6**, 9-10 (1999).
- Haq, M.A. 'Cm 2000' - a new high yielding and disease resistant variety of kabuli chickpea released in Pakistan. *Saic Newsletter* **11** (2001).
- Nuclear Institute for Agriculture and Biology. Thirty Years Of Niab. 6th five-year report. Faisalabad, Pakistan, Niab, 132 (1992).
- Konzak, C.F., Nilan, R.A., Kleinhofs, A. Artificial mutagenesis as an aid in overcoming genetic vulnerability of crop plants. In: Genetic Diversity In Plants, (Eds Muhammad Amir, Askel, Rustem and Von Borstel, R.C.) Plenum Press, NY, 163-177 (1976).
- Ahloowalia, B.S., Maluszynski, M. Induced mutations - a new paradigm in plant breeding. *Euphytica* **118**, 167-173 (2001).
- Maluszynski, M., Vanzanten, L., Ashri, A., Brunner, H., Ahloowalia, B., Zapata, F.J., Weck, E. Mutation techniques in plant breeding. In: Induced Mutations And Molecular Techniques For Crop Improvement, IAEA, 489-504 (1995).

Socio-Economic Impacts of Mutant Rice Varieties in Southern Vietnam

K T Do

Abstract

Rice production plays an important role in the socio-economic development of Vietnam, especially in the **Mekong River Delta** (MRD) region, which is responsible for more than half of the total and 90% of the national rice export. Before 1995, no **mutant rice varieties** (MRVs) were cultivated in the MRD. At present, rice variety improvement is the main focus of the national breeding programme and 8 rice mutants have been developed, occupying 10.3% of the total modern varieties in Southern Vietnam. The mutant varieties developed so far have better resistance to lodging, disease and insect damages, higher tolerance to soil stresses such as acid sulphate soil, drought etc., and also exhibit earliness and higher yield potential. Some of the best mutant varieties, namely VND95-19, VND95-20, VND99-3, TNDB-100 have already been released for large-scale production in the MRD. VND95-20 has become one of the top 5 exported varieties and is grown annually on more than 300,000 ha in Southern Vietnam.

Some of these mutants have given promising recombinants through hybridization and in particular the varieties VN121, VN124, OM2717 and OM2718 have been released into production. A successful combination of aromatic characteristics, short duration, high yield, tolerance to new diseases (GSV & RSV) and insects (BPH), and consequent reduction of spraying times of pesticide per crop, have greatly benefitted health & environmental protection.

During the past 8 years under the IAEA Technical Co-operation (TC) project, the total cultivated area of MRVs in Southern Vietnam has been more than 2.54 millions ha. Until 2008, the 8 rice mutant varieties produced an added return of 374 million USD over the previous years and continue to produce added return for farmers. More specifically, VND95-20, VND99-3, TNDB100, VND95-19, OM2717, OM2718, VN121 and VN124 returned 300.00, 9.0, 37.5, 6.0, 12.0, 8.4, 0.8 and 0.7 million USD, respectively. The application of MRVs reduced spraying times per crop two- to three-fold due to their tolerance to diseases & insects.

MRVs are used in the strategy programme '*Eradicate hunger and alleviate poverty*' of different national projects, particularly for the ethnic minorities in mountainous and remote regions of Southern Vietnam. Due to the significant contribution of MRVs to socio-economic development, their development has received many prizes by the national & local Government.

Introduction

Vietnam is an agricultural country and 73.5% of its population lives in rural areas. In 2006, Vietnam's Gross Domestic Product (GDP) was valued at 973,790 billion VND (Vietnamese dong) (at current prices, equivalent to 60.86 billion USD). Agriculture & forestry GDP shared 12.39 billion USD, which occupied 20.36% of the total national GDP [1].

Rice plays an important role in the socio-economic development of Vietnam. The country has made great achievements in paddy production and has become the second largest rice exporting country in the world since 1989. Paddy production is a traditional activity of Vietnamese farmers, hence it always holds the central role in Vietnam's agriculture and socio-economic issues. The rice sector accounted approximately for 37.0% of agricultural GDP and 26.0% of the agricultural product export value between 2000-2004.

In 2006, the paddy land and sown areas were approximately 4.2 million ha and 7.3 million ha, respectively, occupying 16.9% of the agricultural and 65.3% of the annual crop land areas.

In 2007, total rice production was 36.0 million tons, of which 4.5 million tons was exported (valued at about 1.5 billion USD). The Mekong River Delta (MRD) produced 18.73 million tons (52% occupation) and exported 4.0 million tons (90% of the total rice export). Over the past 20 years, Vietnam has exported 60 million tons of rice to different continents of the world, averaging 4.5 million tons per year for the period between 2002-2007. This has been achieved thanks to the reformed Government policy and the innovative technologies used. Breeding of modern varieties has played an important role in agriculture and increasing the income for farmers.

Between 1987-2006, 78 rice varieties were released in Southern Vietnam: 32 by introduction (41.0%); 33 by hybridization (42.3%); 8 by mutation (10.3%); and 5 by pure line selection (6.4%). Before 1995, there were no mutant rice varieties in production, in Southern Vietnam. Consequently, the rice varieties delivered solely by introduction and hybridization could not meet the production requirements, particularly concerning varieties having traits with high tolerance to adverse conditions, high yield & good quality.

Since 1992 rice mutation breeding combined with other methods has been undertaken, leading to the successful creation of mutant varieties with distinct characteristics, which have significantly affected the socio-economic issues of Southern Vietnam. Some of the best mutant varieties, VND95-19, VND95-20, VND99-3, TNDB-100, OM2717 and OM2718 have been released for large-scale production in the MRD region. Among them, VND95-20 has become one of the top 5 exported rice varieties and is grown on more than 300,000 ha in Southern Vietnam [2]. Some mutants gave promising recombinants in aroma, tolerance to BPH, Grassy Stunt Virus (GSV) & Ragged Stunt Virus (RSV) diseases. Selected varieties such as VN121, VN124 have been released into production in recent time [3].

Breeding, development and production of mutant varieties

Mutation breeding

Since 1993, under the IAEA Technical Co-operation (TC) project since 1997, the mutation breeding programme was initiated for rice. The breeding programme used introduced varieties (IR64, IR50404), local varieties (Nang Huong, Tam Xoan, Tai Nguyen and Tep Hanh) and mutants (VND31, VND22-36) as genetic material to be induced with

Institute of Agricultural Sciences for Southern Vietnam
Phone: 84-8-38297889; Fax: 84-8-38297650

Email: iasvn@vnn.vn / dokhactinh_52@yahoo.com.vn

mutations and combined with hybridization. After 5-6 years, the best mutants were released into production. Methodically, dry and germinated seeds were exposed to gamma rays of a ^{60}Co source at the Nuclear Research Institute, Dalat city, Southern Vietnam. The doses of 200 and 300Gy were applied for seed treatments. Populations of 10,000 – 15,000 M_1 plants were established and evaluated from M_2 to M_7 generations. The best lines were tested, released and approved as temporary and national varieties by the Ministry of Agriculture & Rural Development (MARD).

Development and production of mutant varieties

IR64 is good quality variety but has a rather long duration, and is not suitable for the wet season. VND95-20 is a mutant variety derived from IR64. The variety inherited the main good characteristics of IR64 and added some desired characteristics through mutation.

VND95-20 was released into production & approved as a national variety by MARD in 1999. Since 2000, VND95-20 has been developed in 21 provinces over 280,000 – 350,000 ha per year. The variety is cultivated in Dong Thap, Long An, Tien Giang, Can Tho, Tra Vinh, An Giang, Vinh Long (Mekong River Delta), Dong Nai, Lam Dong, Tay Ninh, Baria-Vung Tau (East-Southern VN), Daklak and Gialai (Highland area). Recently, VND95-20 has been the key variety for production and export. Advantages of this mutant variety is short duration 90-100 days (7 days shorter than the original variety IR64), high adaptation and can be cultivated in diverse seasons and locations. Generally, mutant varieties are tolerant to intermediate acidic soil. This characteristic is very important because the acidic soil in the Mekong River Delta region covers more than 41% of the total cultivated land.

VND95-19 (another mutant from IR64) has high yielding potential (can yield 11 tons /ha), high tolerance to acidic soil and adverse conditions. The variety is resistant to Brown Plant Hopper (BPH) and Blast disease (BL), and is developed in several provinces: Soc Trang, Bac Lieu, Kien Giang, Dong Nai and the Highland area [4]. During 1997-2000 its cultivated area covered about 20,000ha per year. However, due to high chalkiness, the variety is only for domestic consumption.

VND99-3 is a mutant variety obtained from the Nang Huong variety, a local aromatic variety. The Nang Huong variety has long duration, low yield, photoperiodic sensitivity and is limited in production. VND99-3 was approved as a national variety in 2006. It is highly accepted due to having short duration (92-100 days), high tolerance to adverse conditions such as acid sulphate and drought conditions in Southern Vietnam. These improvements combined with iron toxicity tolerance, show that the mutant variety has inherited desirable traits from the parent local variety and shows similar characteristics or better than the original variety. Presently VND99-3 covers 15,000-18,000 ha per year of cultivated area in Southern Vietnam and continues to spread widely in Southern Vietnam [5].

TNDB100 is an induced mutation from the Tai Nguyen local variety, generated by gamma rays. The variety has very short duration (95-100 days), good quality, high yield (5-8t/ha) and intermediate tolerance to BPH and BL. TNDB100 was released by Cuu Long Delta Rice Research Institute (CLRRI) in 1997 and developed 50,000 ha/year during 2000 – 2005 [6].

VN121 is a new variety which was generated from mutation induction combined with hybridization. VN121 is widely accepted by farmers, because of its characteristic short duration, high yield, good quality (aroma, long grain, no chalkiness) and its tolerant to BPH, BL and GSV. The variety has been expanded in some Southern provinces: Tien Giang, Long An, Ba Ria - Vung Tau, Dong Nai, Tay Ninh & Dak Lak.

The VN124 variety has also been accepted for production due to its very short duration, aroma, good quality for export, tolerant to BPH, BL and GSV. The variety has been sharply expanded in Long An, Tay Ninh, Dong Nai and other provinces.

Socio-economic and environment impacts

Socio - economic impacts

Before 1995, in Southern Vietnam, many had thought that mutation breeding had very little hope and also that mutant varieties could not be stable in production. Through the developments of recent years, however, it has been proven that mutation breeding is a very good way to obtain novel varieties and that mutant varieties have a prolonged production life (more than ten years in the case of VND95-20). Nowadays, through practical approaches, many leaders and junior scientists have changed their doubtful thinking and have started to believe in the significant role of mutation breeding.

In general, mutation breeding has the advantage of saving 30% of the breeding programme time compared to hybridization techniques, especially in local varieties. While breeding new varieties takes 8-9 years or more, new varieties through mutation breeding takes only 5-6 years [7]. Mutation breeding is a very useful tool that can be applied in institutions that lack infrastructure such as green houses, field areas etc.

The rice mutation breeding programme of IAS and CLRRI have an annual budget of about 20,000 USD, so 300,000 USD from 1992 up to 2007. A quick calculation for the variety VND95-20 that is cultivated on average over an area of 250,000 ha (from 200,000-340,000 ha/year) x 8 years (from 1999 - 2007) x a yield of 6.0t/ha x 10% added return (in practical production it gets a higher yield than 10%) x 4 million VND/ton of rough rice (VND/t is price for ordinary paddy) gives us 4,800 billion VND (equivalent to 300 million USD). Exported rice is usually 20-25% higher in price than the ordinary domestic rice.

A similar calculation for VND99-3's added return, 15,000 ha x 4 years x a yield of 6.0t/ha x 10% added return x 4 millions /t gives us 144 billion VND (equivalent to 9.0 million USD). In the case of the varieties like TNDB100, VND95-19, OM2717, OM2718, VN121 and VN124 the produced added return reaches 37.5, 6.0, 12.0, 8.4, 0.8 and 0.7 million USD, respectively (Table 1). Support from international programmes (IAEA and others) and investments in the rice project of the IAS and the CLRRI was about 400,000 USD. With an added return of 374.0 million USD from 8 mutant varieties in Southern Vietnam makes this project a very effective investment. For poor countries, the influx of money depends greatly on agricultural activities, at a significant level, particularly for farmers and rice exporters. These mutant varieties will continue to produce valuable return in coming years. For the past 8 years, the total sown area of the mutant varieties has been about 2.45 millions ha in Southern Vietnam.

Due to their high adaptation in large-scale production, different seasons and tolerance to adverse conditions, the mutant varieties were the main varieties selected in many national projects of "Eradicate hunger and alleviate poverty" programmes of the Vietnam Government in Southern Vietnam. These mutant varieties have contributed food security for the ethnic minorities such as Ragley, St'ieng, Nung, K'ho, Kh'me leading to better condition for forest protection in mountainous regions.

For example, the large number of Ragley ethnic people in the Khanh Dong hamlet, the Khanh Vinh district and the Khanh Hoa province usually have the conventional habit to collect forest products and exchange them for food as they do not know cultivation. Every year, the local government offers assistance for food and necessary items to the inhabitants, but it can not resolve the basic problem because hunger and poverty remain. To resolve the problem, we cooperated with local collaborators to conduct a project for technology transfer including the adoption of new rice varieties by the poor ethnic groups during 2003-2005. After 2 years into the project, ethnic people had cultivated VND95-20 and VND95-19 with high yield (6.4 t/ha) in comparison to other varieties that yielded only 4.4t/ha. Due to VND95-20's high adaptation, and good quality, local people preferred to grow this variety for two crops per year. Consequently, local people escaped from hunger, poverty diminished

and deforestation stopped. Now they have a sustainable base to improve living conditions, beginning from having enough and surplus food.

Another example related to mutant rice varieties was the 2006-2007 outbreak of the Grassy Stunt Virus disease in the Southern areas, transmitted by Brown Plant Hopper. The Vietnam Government organized a campaign to mobilize different actions to control the pest. Our role was to transfer new tolerant varieties into production. In some provinces we supplied new varieties (including mutant as VND95-20, VND99-9, VN121 and VN124) and guided the production procedure in adverse conditions. As a result, in the Tay Ninh province and the Ben Cau district during the rainy season of 2007, the mutants yielded on average 5.1 t/ha compared to the local varieties that yielded only 4.1t/ha. Due to farmers having reduced insecticides, fertilizers and seed rate with a total spending reduction of 27,0% (about 175 USD/ha) in the production model of the mutant varieties, the added return from the use of mutants increased by 437.5 USD/ha over the concurrent ordinary varieties.

Environmental impacts

Mutant varieties have high tolerance to insects and diseases, so pesticides were applied two- to three-fold less during production in comparison to that for susceptible varieties. This not only saves investment capital and improves the safety of the rice products, but also strongly protects human and animal health.

Economic impacts

- Over the past 8 years, the total cultivated area of MRVs in Southern Vietnam has reached about 2.54 million ha.
- The mutant varieties contributed for production have produced added returns of (in millions USD): VND95-20 (300.0); VND 99-3 (9.0); TNDB 100 (37.5); VND95-19 (6.0); OM 2717 (12.0); OM 2718 (8.4); VND 121 (0.8) & VN124 (0.7).
- 8 mutant varieties contributed an added return of 374 million USD over the past years and will continue to provide valuable return for farmers in future crops.
- The new mutant varieties are tolerant to new diseases and insects, have replaced susceptible varieties and will continue to have a significant impact on sustainable rice cropping systems in the future.

Innovative techniques of MRVs

- Higher yield of more than 10% in comparison to control varieties.
- Very short growth duration: MRVs can be cultivated for 2-3 crops per year, escaping early flooding.
- Tolerance to adverse conditions, large adaptation allowing MRVs to be cultivated in different areas (acid soil, alluvial, affected salinity, wet season).

Table 1. Mutant rice varieties & their economic impacts in Southern Vietnam

No.	Mutant variety	The year of release	Cultivated area since release (ha)	Added return since release time (million USD)	Main superior characters
1	VND95-20	1999	2,000,000	300	Large-scale adaptation, good quality,
2	VND 99-3	2004	60,000	9.0	Tolerant to acid soil, good plant type
3	TNDB100	1997	250,000	37.5	Good quality, short duration
4	VND95-19	1999	50,000	6.0	Tolerant to acid soil, good plant type
5	OM2717	2004	100,000	12.0	Tolerant to BPH, short duration
6	OM2718	2004	70,000	8.4	Tolerant to BPH, short duration
7	VN121	2007	5000	0.8	Aromatic, tolerant to BPH, GSV
8	VN124	2007	5000	0.7	Aromatic, tolerant to BPH, GSV
Total	-	-	2,540,000	374.4	-

Prizes for achievement from mutant varieties in Southern Vietnam
Due to the significant contributions to socio-economic development, the development of mutant rice varieties has received many prizes by from national & local governments and they are as follows :

1. First prize and Second prize in the Technology Creative Competition in Ho Chi Minh City, 1998
2. 2 Gold medals in the Fair of “ International Green Week” exhibition in Vietnam, 2000
3. 1 Golden Panicle Prize in the International Agriculture Fair organized in Can Tho, 1999
4. The National Prize on Science & Technology for Significant Contribution for Socio-economic issues of the country, 2005
5. Prizes for 30 Typical Science & Technology Achievements during the 30 years of the HCM City, 2005
6. The Golden Cup for Agriculture Products contributed to the country, National Agriculture Fair in 2006
7. The Creative Labor medal awarded by the Vietnam government, 2007

Conclusion

In brief focus, some significant impacts of the mutant rice varieties in Southern Vietnam are described below.

- Successful combination of aromatic characteristics with short duration, high yield, tolerant to diseases (BL, GSV & RSV) and insects (BPH).
- Shorter breeding times, reaching 30% reduction compared to hybridization methods.
- Confirmation that doses of gamma ray ⁶⁰Co treatment induces high mutation.

Socio–Environmental impacts

- MRVs are resistant to insects & diseases: Two- to three-fold reduction of spraying times per crop, saves production investment capital and protects from pesticide over-usage.
- Contributed to the strategy programme of “Eradicate hunger and alleviate poverty” and “Deforestation reduction” of different national and local projects, particularly for the ethnic minorities in mountainous and remote areas.

BIBLIOGRAPHY

1. Statistical Publishing House. Statistical year book 2006, Socialist Republic of Vietnam, General Statistical Office, Ha Noi.
2. Ministry of Agriculture & Rural Development. Introduction of rice varieties and seeding times in Mekong Rive Delta, Agriculture Publishing House, HCM city, 2006.

3. Thinh Do Khac, Dao Minh So *et al.* Application of radiation mutation combined with hybridization to breed rice varieties having short duration, resistance to insects, diseases and high quality for export, Report in International conference on New Results of Rice Research organized by IRRRI & CLRRI, 8 - September, 2007, Can Tho.
4. Thinh Do Khac, Hung Phi Oanh, Nguyen Thi Cuc *et al.* Improvement of introduced rice varieties through radiation induced mutation for cultivation in Southern Vietnam, reported at FAO/IAEA seminar on Mutation Techniques and Molecular Genetics for Tropical & Sub-tropical Plant Improvement in Asia / The Pacific region, Philippines, 11-15 Oct. 1999.
5. Thinh Do Khac, Dao Minh So, Truong Quoc Anh *et al.* Breeding & Development of Mutant Variety VND99-3 reported in Scientific Conference Ministry of Agriculture & RD, March 1-3, 2005 in Ho Chi Minh city.
6. Ro Pham Van. Two Promising Mutant Rice Varieties in Results of Scientific Research, 1977-1997, Institute of Cuu Long Delta Rice Research, Omon – Cantho, Vietnam, Pub. House of Agriculture 1998.
7. Thinh Do Khac *et al.* Rice mutation Improvement for short growth duration, high yield and tolerance to adverse conditions in Mekong River Delta of Vietnam, reported at FAO/IAEA/RCA Strategic Meeting on Nuclear Techniques for Rice Improvement in Asia, 4-7 November 2004, Tokyo & Tsukuba, JAPAN.

Concurrent Session 1

Mutation Enhancement of Genetic Diversity and Crop Domestication

Mutational Events in a Homeobox Gene *Vrs1* that Created a Six-Rowed Spike in Barley Domestication

T Komatsuda* & M Pourkheirandish

Abstract

Early cultivators of barley (*Hordeum vulgare* ssp. *vulgare*) selected a phenotype with a six-rowed spike that stably produced three times the usual grain number during domestication. *SIX-ROWED SPIKE 1* (*Vrs1*) isolated from barley encoded a homeodomain leucine zipper I-class protein (HD-ZIP I), a potential transcription factor. *Vrs1* is expressed only in lateral spikelet primordia of the early developmental stage. Fifty-four six-rowed mutant lines showed mutational events at the *vrs1* gene except for five mutant lines, which suggested mutational events at the regulatory regions of *Vrs1*. We found three haplotypes among six-rowed barley revealing loss-of-function mutation of the homeobox gene *Vrs1*, while another allele showed no DNA changes throughout the coding region of the *Vrs1* gene indicating another origin of the six-rowed barley.

Introduction

Throughout the process of cereal domestication started about 10,000 years ago [1-3], humans have deliberately selected individuals of wild species to emphasize seed recovery [4-6] and improved seed yield [1, 7]. The appearance of six-rowed spikes during the domestication of barley (*Hordeum vulgare* ssp. *vulgare*) is one of the most conspicuous instances of this process. The barley spike is composed of “triplets” (each with one central and two lateral spikelets) arranged alternately at rachis nodes. All three spikelets of six-rowed barley are fully fertile and develop into grains, but the lateral spikelets of two-rowed barley are reduced in size and sterile. Wild barley (*H. vulgare* ssp. *spontaneum*), the progenitor of cultivated barley [1, 8], is two-rowed, and its arrow-like triple spikelets are an adaptive specialization that ensures the seeds will bypass stones and pebbles and reach soil when they fall to the ground [9]. Spontaneous six-rowed mutants are eliminated naturally from wild barley population, thus, six-rowed barley occurs primarily as cultivars or weeds [8].

The development of a six-rowed spike is controlled by a single allele, *vrs1* (formerly *v* for *vulgare*), that is recessive to the dominant allele responsible for the two-rowed spike (*Vrs1*) [10, 11]. *Vrs1* has been the primary target of mutation during the evolution of six-rowed barley. It has been assumed that six-rowed barley developed from domesticated two-rowed barley by means of spontaneous mutation [1, 12], but the origin of six-rowed barley has not yet been confirmed. Recently, map-based cloning of the *vrs1* gene revealed that *Vrs1* encodes a member of the homeodomain-leucine zipper (HD-ZIP) I class of transcription factors [13, 14]. Transcription of *Vrs1* was abundant during the early developmental stages of the immature spike, and *Vrs1* was expressed only in the lateral spikelet primordia. The dominant nature of *Vrs1* suggests *VRS1* protein represses directly or indirectly the expression of genes for the development of lateral spikelets. In this paper, mutational events at the homeobox gene *Vrs1* in mutant lines were characterized to infer the function of the *Vrs1* gene.

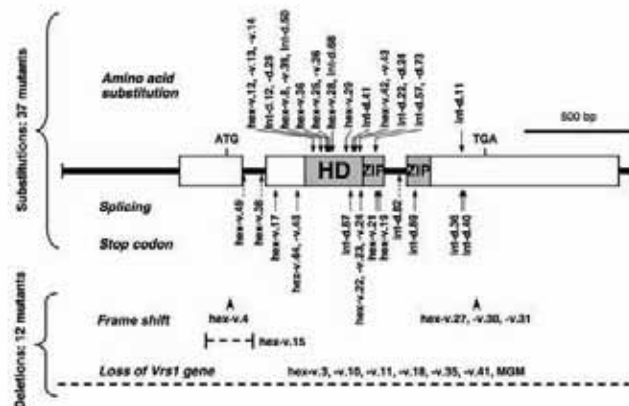

Figure 1 Analysis of mutants allelic to *vrs1*. Lesions at *Vrs1* detected in 49 mutants. Arrows pointing down indicate amino acid substitutions, arrows pointing up with a solid line indicate new stop codons, and the 3 arrows pointing up with a dotted line indicate single nucleotide substitutions in the introns with a changed splicing. The arrowheads and horizontal broken lines indicate deletions, where five mutants have a partial deletion and seven mutants have a complete deletion of *Vrs1*. After [13] with slight modifications.

Variable mutational events at *vrs1* in mutant lines

DNA sequences of a total 57 mutants, which were derived from five two-rowed cultivars mainly by the Swedish mutation research group [11], were analyzed [13]. The *hexastichon* (*hex-v*) mutants have six-rowed spikes with fully fertile, well-developed, and long-awned lateral spikelets [15], and thus resemble normal six-rowed barley. The *Intermedium spike-d* (*Int-d*) mutants produced sterile or partially fertile lateral spikelets with variable awn length. Allelism of these mutations with *vrs1* was documented in a previous study [16]. Lesions in *Vrs1* were correlated with morphological changes in 49 mutant lines. Twenty-two mutant lines revealed a single amino acid substitution, where most of their mutations were located at the homeobox (Fig. 1). Twelve mutant lines revealed truncation of the protein by a new stop codon. Amino acid substitution and creation of new stop codon at the 3' region downstream the HD-ZIP region also resulted in the change of row type indicating there are some additional functions at this region (Fig. 1). Three mutant lines showed a single nucleotide substitution in the conserved GT-AG splicing sites of introns (Fig. 2A). These mutants showed modified mRNA splicing of their *Vrs1* transcripts by deleting or replacing the conserved GT-AG splicing sites (Fig. 2B).

Five mutant lines had a frame shift mutation caused by a deletion, and seven revealed complete deletion of the *Vrs1* region [13]. These deletions (>182 kb), which were generated by means of irradiation, always resulted in *hex-v*-type six-rowed spikes under a range of growing conditions [13]. The phenotypes observed in mutants that consistently exhibited six-rowed spikes support our hypothesis that complete deletion of *Vrs1* occurred. Since the 7 deletion mutants did not show any developmental lesions, *Vrs1* appears to be dispensable in barley.

National Institute of Agrobiological Sciences (NIAS), Plant Genome Research Unit, Kan-non-dai 2-1-2, Tsukuba, Ibaraki 305 8602, Japan.

* Corresponding author. E-mail: takao@affrc.go.jp

We detected five mutants that did not show any DNA changes throughout the coding region of *Vrs1* (*Int-d.80*, *hex-v.7*, *hex-v.16*, *hex-v.33*, and *NGM13*). Expression analysis showed that all of the five mutants exhibited no transcripts of *Vrs1*. This result suggests the occurrence of the mutational events in regulatory regions for *Vrs1*. The regulatory elements may correspond to 5' up-stream cis-elements of the *Vrs1*, but it was also noticed that the *hex-v.33* mutant has a small deletion of a DNA sequence corresponding to *e34m13-260S* marker at the 3' down-stream of *Vrs1* (Supporting Information of Table 2 in [13]).

hex-v.46, *hex-v.47* and *hex-v.48* were also included in this category because no DNA changes were detected, but gene expression was detectable. Further allelism test, crossing these mutant lines with *hex-v.23* (stop codon) and *hex-v.49* (splicing modification) as testers indicated that these mutants do not have genes allelic to the *vrs1* locus because lateral spikelets of the F₁ plants were very poorly developed (data not shown). In a separate allelism test, all three *hex-v* mutants (*hex-v.46*, *47* and *48*) got crossed to *hex-v.3* and *hex-v.4*. In F₁ all of them were noticed as a very weak six-rowed spike or only S plants (pointed lateral spikelets with very short awns), suggesting that *hex-v.46*, *47* and *48* are no six-rowed mutants (U. Lundqvist, personal communication). It was noted that the three mutants were not typical six-rowed spikes and irregular, and *hex-v.48* looks similar to *intermedium* (*int-e.26*) mutant. Therefore the three mutants must be excluded from *hex-v* mutant lines. Since the *hex-v.46* showed a transcription level of *Vrs1* the same as two-rowed barley.

hex-v.08 was scored without any DNA changes throughout the coding region of *Vrs1* [13], but detailed analysis of the DNA sequence and resequencing revealed that the mutant had a single amino acid substitution at the homeodomain of *Vrs1* as did *hex-v.39* and *Int-d.50*. Therefore, data concerning *hex-v.08*, *46*, *47* and *48* reported previously [13] were corrected in this paper.

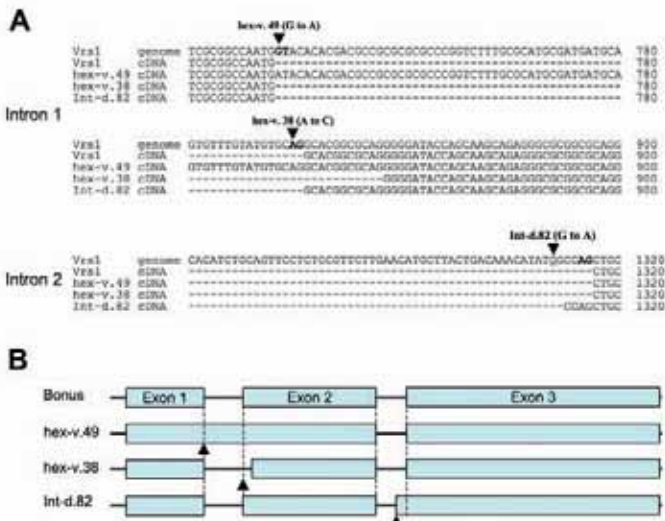

Figure 2 Analysis of mutants with a single nucleotide substitution in the conserved splicing sites of introns in *Vrs1*. (A) Splicing changes in first intron and second intron results from nucleotide substitutions. Arrows pointing up indicate the position of a single nucleotide change in Bonus. (B) Scheme of cDNA for the three mutants through the expression analysis. Broken lines indicate the original splicing site in functional *Vrs1*.

Mutational events at *vrs1* in cultivated six-rowed barley

Survey of barley cultivars and wild barley identified *Vrs1.b2* and *Vrs1.b3* alleles in two-rowed barley and *vrs1.a1*, *vrs1.a2*, and *vrs1.a3* alleles in six-rowed barley [13]. *vrs1.a1* and *vrs1.a2* have a deletion and insertion of

one nucleotide respectively, which results in a frame shift of the deduced amino acid sequence of VRS1. The *vrs1.a3* allele has a substitution of one nucleotide in which an amino acid at a highly conserved position in the DNA-binding domain was substituted. The DNA sequences were identical among each allele except that the *vrs1.a1* had three sub-haplotypes due to SNPs at the non-coding region. A direct descent of *vrs1.a2* from *Vrs1.b2* and *vrs1.a3* from *Vrs1.b3*, as a result of point mutation were deduced. The progenitor of the *vrs1.a1* allele remains to be identified.

In addition, *vrs1.c* allele was found in "Arlington Awnless" (awnless) and "Hayakiso 2" (lateral spikelets awn-reduced), but all the spikelets are filled with grains producing six-rowed spikes. These six-rowed forms occur in East Asia, most dominantly in Tibet and Nepal. These cultivars did not reveal a change of amino acid sequence at VRS1 from two-rowed. The progenitor of the *vrs1.c* allele remains also to be identified.

Discussion and Outlook

Deletion mutants are powerful tools for the initial gene targeting by map-based cloning. Gene identification and biological function of genes could be confirmed by analysis of mutant lines revealing single nucleotide substitutions and insertion/deletions. Our study indicated that mutant lines are extremely useful for the identification not only of coding regions of target genes but also of their non-coding regions such as splicing sites and cis-regulatory elements. Secure storage of mutant lines and their systematic documentation are essential for sustainable molecular genetics in plants, especially cereal plants in which analysis of biological gene function by transformation remains difficult.

The creation of six-rowed spikes in the loss of function nature is similar to the gigantism that occurs during domestication [17]. The dominant nature of *Vrs1* and the potential DNA-binding activity of HD-ZIP I proteins suggest that VRS1 is a repressor protein that may bind to the DNA of genes that regulate the development of lateral spikelets. Further investigation of the subcellular localization of VRS1 proteins will be necessary to test this hypothesis. Expression analysis of genes downstream of *Vrs1* could link the *vrs1* mutations and morphological changes in barley spikes.

The inflorescence architecture in the Poaceae could be a continuous story of reduction from a more original "panicle" (as seen in rice and oats) to a "spike" [18]. Spikes contain a single sessile spikelet per node in wheat and rye and three sessile spikelets per node in barley. In two-rowed barley, strict temporal and spatial regulation of *Vrs1* expression leads to reduction and sterility of the lateral spikelets. We speculate that either strong alleles or differential regulation of *Vrs1* orthologs could lead to complete repression of lateral spikelet formation at inflorescence nodes found in wheat and rye. A Poaceae-wide assessment of variability and regulation of *Vrs1* orthologs would be an exciting and productive way to improve our understanding of plant development and of the evolution of grass species.

ACKNOWLEDGEMENTS

This work was funded by research grant TRC1004 from the Ministry of Agriculture, Forestry and Fisheries of Japan (MAFF) to T. Komatsuda. M. Pourkheirandish is a research fellow supported by Japan Society for the Promotion of Science (JSPS).

BIBLIOGRAPHY

- Zohary, D., Hopf, M. Domestication of plants in the old world (Oxford, New York) (2000).
- Salamini, F. *et al.* Genetics and geography of wild cereal domestication in the Near East. *Nat Rev Genet* **3**, 429-441 (2002).
- Doebley, J. The genetics of maize evolution. *Annu Rev Genet* **38**, 37-59 (2004).
- Li, C. *et al.* Rice domestication by reducing shattering. *Science* **311**, 1936-1938 (2006).

5. Konishi, S. *et al.* An SNP caused loss of seed shattering during rice domestication. *Science* **213**, 1392-1996 (2006).
6. Simons, K. *et al.* Molecular Characterization of the major wheat domestication gene Q. *Genetics* **172**, 547-555 (2006).
7. Harlan, J.R. *et al.* Comparative evolution of cereals. *Evolution* **27**, 311-325 (1973).
8. von Bothmer, R. *et al.* An ecogeographical study of the genus *Hordeum*, 2nd ed. Systematic and Ecogeographic Studies on Crop Genepools 7. (International Plant Genetic Resources Institute, Rome) (1995).
9. Zohary, D. In: Proc 1st Internat Barley Genet Symp., Wageningen (Barley Genetics I), Wageningen, The Netherlands), 27-31 (1963).
10. Ubisch, G. Beitrag zu einer Faktorenanalyse von Gerste. *Zeits Ind Abs Ver* **17**, 120-152 (1916).
11. Lundqvist, U. *et al.* New and revised descriptions of barley genes. *Barley Genet Newsl.* **26**, 22-516 (1997).
12. Harlan, J. R. In: Barley: Origin, Botany, Culture, Winterhardiness, Genetics, Utilization, Pests. Agriculture Handbook No. 338 (U.S. Department of Agriculture, Washington, D.C.), 9-31 (1968).
13. Komatsuda, T. *et al.* Six-rowed barley originated from a mutation in a homeodomain-leucine zipper I-class homeobox gene. *Proc Natl Acad Sci USA* **104**, 1424-9 (2007).
14. Pourkheirandish, M. *et al.* Analysis of the barley chromosome 2 region containing the six-rowed spike gene *vrs1* reveals a breakdown of rice-barley micro collinearity by a transposition. *Theor Appl Genet* **114**, 1357-65 (2007).
15. Gustafsson, A., Lundqvist, U. Hexastichon and intermedium mutants in barley. *Hereditas* **92**, 229-236 (1980).
16. Lundqvist, U., Lundqvist, A. Induced intermedium mutant in barley: origin, morphology and inheritance. *Hereditas* **108**, 13-26 (1988).
17. Lester, R.N., Daunay, M.C. in Rudolf Mansfeld and Plant Genetic Resources, eds. Knüpffer, H., Ochsmann, J. Gatersleben, Germany), 137-152 (2001).
18. Vegetti, A. C., Anton, A.M. *Flora* **120**, 225-228 (1995).

Irradiation-Induced Wheat-Alien Translocation Lines and their Application in Wheat Breeding

P D Chen*, T D Bie, Y P Cao, S W Chen & X E Wang

Abstract

Wild relatives are rich gene resources for wheat improvement. Transfer of useful alien genes to wheat through development of wheat-alien translocations, especially small alien segment translocations, is important for wheat breeding. Wheat-alien genetic stocks such as amphiploid, addition or substitution lines were irradiated for translocation induction. Mature male or female gametes before flowering on the spikes were irradiated by ^{60}Co -Gamma-rays at doses ranging from 800 to 2240 rad. Chromosome C-banding and genomic *in situ* hybridization (GISH) was used to identify chromosome translocation. Backcross of M_1 plants using normal fresh pollen of common wheat was employed to enhance the transmission rate of various structural changes in their progenies. The results showed that a dose of 800~1200 rad was suitable for pollen irradiation while 1500~2000 rad was suitable for female-gamete irradiation. Irradiation treatment just before gamete maturation is advantageous to acquire more M_1 hybrids with a high frequency of chromosome structural variation. The frequency of plants with at least one translocation chromosome in M_1 could be increased up to 70% through pollen irradiation of *Triticum durum*-*Haynaldia villosa* amphiploid. More than 100 translocated chromosomes have been identified in the BC1 and BC2. Translocations with small alien chromosome segments, 57 terminal and 80 intercalary, were induced through female gamete irradiation conducted on *T.aestivum*-*H.villosa* 6VS/6AL translocation line. For the 2240 Rad dosage treatment, the induction frequencies of interstitial translocation, terminal translocation and deletion were 21.02%, 14.01%, and 14.65%, respectively, which were much higher than those previously reported. The *T.aestivum*-*H.villosa* 6VS/6AL translocation has been used in wheat breeding and many elite cultivars, such as Nannong 9918, Neimai 9, Shimai 14, etc. have been developed and released.

Introduction

Wild relatives of crops are rich in gene resources, such as resistance or tolerance to biotic and abiotic stresses, as well as high yield and good quality. However, because of their distant genetic relations, it is difficult to introduce these useful genes into cultivars by normal crossing, chromosome pairing and recombination between homologous chromosomes. The gene transfer can be achieved by chromosome manipulation, i.e. developing amphiploid, alien addition, and substitution and translocation lines. The amphiploid contains a complete set of the alien chromosomes, and the addition or substitution lines contain a whole chromosome. In these materials, many redundant genes would be introduced into cultivated species along with the target genes. Therefore, the best way for gene transfer should be the production of translocation lines, especially interstitial translocation with a small alien chromosome segment.

Spontaneous alien translocation could be observed as a result of occasional chromosome breakage and re-union in the process of wide hybridization, but the frequency is extremely low and the breakpoint usually occurred near the centromere and produced whole arm translocation. Ionizing-irradiation is a popular method for the induction of chromosome translocation. Irradiation of dry seeds is most convenient, but the frequency of chromosome structure rearrangement is very low. Sears (1956) developed a common wheat-*Aegilops umbellulata* translocation line through irradiating pollen of a *Triticum aestivum*-*Ae.umbellulata* addition line by X-ray, followed by pollinating the irradiated pollen to common wheat cv. Chinese Spring, and successfully transferred leaf rust resistance of *Ae. umbellulata* into common wheat [9]. Irradiation was also used successfully in the transfer of Fusarium head bright resistance from *Leymus racemosus* into common wheat in the form of chromosome translocation [3, 6, 7].

Haynaldia villosa Schur. (syn. *Dasypyrum villosum* Candargy, $2n=14$, VV), a related species of wheat, has been reported to be resistant to powdery mildew, rusts, take all and eyespot diseases, and tolerant to drought and cold stresses. The powdery mildew and spindle streak mosaic virus resistances of *H. villosa* have been introduced into common wheat through development of alien addition, substitution and whole-arm translocation lines (4VS/4DL and 6VS/6AL) in the Cytogenetics Institute, Nanjing Agricultural University (CINAU) [1, 2, 5, 8, 10]. For further fine mapping and better utilization of useful genes of *H. villosa*, it is urgent to develop more translocation involved in different chromosomes, different regions and with various fragment sizes of *H.villosa*.

Materials and Methods

Plant materials

Triticum durum-*Haynaldia villosa* amphiploid and *T.aestivum*-*H.villosa* 6VS/6AL translocation were developed by CINAU and used as basic materials for irradiation. *T. aestivum* cv. Chinese spring was used as the recurrent parent.

Irradiation treatment

Irradiation of mature pollens

Flowering spikes of *T.durum*-*H.villosa* amphiploid were cut off with flag leaves, maintained with their cut lower ends in water, and irradiated with ^{60}Co -Gamma-rays (800 ~ 1600 Rad) at a dose rate 100 Rad/min. Fresh matured pollen harvested from irradiated spikes at 1 ~ 3 days after irradiation was pollinated to emasculated florets of *T.aestivum* cv. Chinese Spring. Matured hybrid seeds were harvested and sown to set up a M_1 population. Pollen collected from untreated *T. durum*-*H.villosa* amphiploid plants was used to pollinate Chinese Spring as a control.

Irradiation of mature female gametes

The mature female gametes, two to three days before flowering, on the plants of 6VS/6AL translocation line 92R137 were irradiated by ^{60}CO Gamma- ray using the dosages of 1600 Rad, 1920 Rad or 2240 Rad.

State Key Laboratory of Crop Genetics and Germplasm Enhancement, Nanjing Agricultural University, Nanjing, Jiangsu 210095, China

* Corresponding author. E-mail: pdchen@njau.edu.cn

The irradiated spikes were emasculated the same day and pollinated with normal fresh mature pollen of common wheat cv. Chinese Spring after two to three days, and the produced hybrids were named as M_1 . Irradiation treatments were carried out at the Jiangsu Academy of Agricultural Sciences.

Cytogenetics and molecular analysis The chromosome translocation between wheat and alien species were detected by genomic *in situ* hybridization (GISH)[11] and C-banding [4].

Results

Induction of chromosome translocation by irradiating mature pollen of *T.durum-H.villosa* amphiplod Fresh mature pollen harvested from irradiated spikes at about one to three days after irradiation with 800~1600 Rad was pollinated to emasculated florets of *T.aestivum* cv. Chinese Spring. The hybridization seed-set rate was 87.2~93.1%, which was similar to the control (89.6~96.0%)(Table 1). In 719 of 1009 M_1 plants, at least one translocation chromosome between wheat and *H.villosa* was detected by chromosome *in situ* hybridization using labeled genomic DNA of *H.villosa* as probe. The average induction frequency was 71.2%. The highest induction frequency of 96.0% was observed in the treatment of 1600 Rad (Table 2). The translocation chromosomes consisted of whole arm, terminal and interstitial translocations with different sizes of alien chromosome segments. These translocation chromosomes could be transmitted to the next generation by backcrossing with normal fresh pollen of common wheat Chinese Spring, and the transmission rates of the translocation chromosomes were 72.9% in the M_1 to BC_1 and 100% in the BC_1 to BC_2 , respectively (Table 3). The transmission rate of translocation chromosome through female gametes was higher than through male gametes (Table 4).

Induction of chromosome translocation and deletion involved in the small segment of 6V short arm by irradiating mature female gametes of translocation line 6VS/6AL The structurally aberrant translocation chromosome (TC) and transmission ratio (TR) involved in the short arm of 6V of *H.villosa* were detected by GISH. Among the 534 M_1 plants, 97 plants with 192 structurally changed chromosomes of 6VS were identified, including 57 terminal translocation, 80 interstitial translocation and 55 deletion chromosomes (Fig. 1). The frequency of plants with small fragment structural changes of 6VS was as high as 18.3%. The highest induction frequency of terminal translocation (14.0%), interstitial translocation (21.0%) and deletion (14.7%) was observed in the treatment of 2240 Rad dosage (Table 5). The backcross seed-set rate using fresh pollen of common wheat Chinese Spring was 70.2%~ 82.5%. Most of the structural changed chromosomes observed in the M_1 were rediscovered in the M_2 . These lines are potentially useful materials for chromosome-based physical mapping. Two heterozygous interstitial translocation lines with a segment of 6VS (FL0.40-FL0.70), which showed high powdery mildew resistance, were obtained.

Utilization of *T.aestivum-H.villosa* translocation 6VS/6AL with *Pm21* The powdery mildew resistance of *H.villosa* has been transferred into common wheat through the development of 6V addition and 6V(6A) substitution lines, and the resistance gene was located on chromosome 6V [1, 8, 5]. *T.aestivum-H.villosa* translocation line 6VS/6AL with powdery mildew resistance was produced by irradiation of the F_3 dry seed derived from the cross of *T.aestivum* cv. Yangmai 5 / *T.aestivum-H.villosa* substitution 6V(6A) in CINAU. The powdery mildew resistance gene was further located on the short arm of 6V and designated as *Pm21* [2]. Up to now, using the translocation lines as parents, new varieties including Nannong 9918, Neimai 8~10, Shimai 14, Shimai 15, Zhongyu

Table 1. Hybridization seed-set rates in different treatment dosages.

Treatment	2006			2007		
	No. of florets pollinated	No. of hybrids obtained	Percentage of seed set	No. of florets pollinated	No. of hybrids obtained	Percentage of seed set
OR	317	284	89.6	227	218	96.0
800R	855	759	88.8	612	570	93.1
1200R	763	665	87.2	843	781	92.6
1600R				1107	1003	90.6

ORcontrol

Table 2. Effect of different dosages on the production of intergeneric translocations.

Treatment	2006					2007				
	No. of plants observed	No. of plants with TCs	Occurrence frequency of TCs	No. of total TCs	No. of TCs per plant	No. of plants observed	No. of plants with TCs	Occurrence frequency of TCs	No. of total TCs	No. of TCs per plant
800R	98	54	55.1	112	1.14	93	46	49.5	83	0.89
1200R	98	75	76.5	165	1.68	93	70	75.3	177	1.90
1600R						100	96	96.0	239	2.39

TCs translocation chromosomes

Table 3. Recovery analysis of translocation chromosomes in different generations.

Generation	No. of plants investigated in the former generation	No. of TCs investigated	No. of plants investigated in the later generation	No. of TCs recovered	Recovery frequency %
M_1 - BC_1	18	48	65	35	72.9
BC_1 - BC_2	22	39	370	39	100.0
BC_2 - BC_3	18	20	247	20	100.0

TCs translocation chromosomes

9 and Yuanzhong 175 etc., have been developed and released from different breeding institutes of China, and a number of elite lines have been selected for national regional tests.

Table 4. Analysis of translocation transmission by male and female gametes from BC2 to BC3 generation.

	No. of plants investigated	No. of plants detected with translocation	Transmission rate (%)
Female gametes	221	75	72.9
Male gametes	221	56	100.0

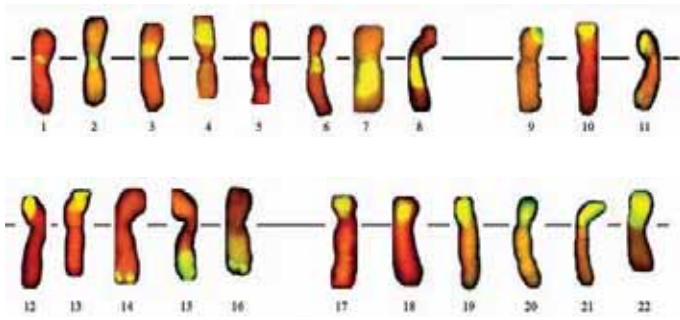

Figure 1 Part of structurally changed chromosomes involving the short arm of 6V chromosome of *H. villosa* detected by GISH in M_1 plants. 1-8: interstitial translocation chromosomes with small fragments, 9-16: terminal translocation. chromosomes, 17-22: deletion of chromosome 6VS.

Table 5. Effect of different irradiation dosages on the induction frequency of small fragment structural changes of 6VS.

Treatments	Inducing frequencies of small fragment structural changes	Inducing frequencies of interstitial translocation	Inducing frequencies of terminal translocation	Inducing frequencies of chromosome deletion
2240Rad	24.84	21.02	14.01	14.65
1920Rad	21.30	18.93	12.43	10.06
1600Rad	10.58	7.21	6.73	7.21
Control	0.00	0.00	0.00	0.00

Discussion

For mass production of various translocation lines involving different alien chromosomes or chromosome fragments, the *T. durum*-*H. villosa* amphiploid containing a complete set of *H. villosa* chromosomes were used for irradiation and at least one translocation chromosome was observed in 72% M_1 plants. The identified translocation chromosomes involved different fragments and regions of chromosome 1V to 7V of *H. villosa*. These translocation lines could be further used for the construction of translocation pools and were useful genetic resources for the introgression and further utilization of alien genes as well as physical mapping of the target genes.

In order to improve the efficiency for creation of interstitial translocations, the whole arm translocation 6VS/6AL was used in the present research for irradiation. In this case, one breakage in the alien chromosome can generate small fragment interstitial or terminal translocations, or deletions of the alien chromosome. We found that not only small fragment terminal translocations and deletions but also intercalary translocations were observed at a high frequency.

The increase of dosage and dosage rate will significantly increase the frequency of breakage-reunion events, including double breakage-reunion events, hence producing more chromosome structural changes, especially interstitial translocation. We used mature female gametes of 6VS/6AL for irradiation because female gametes were less lethal-sensitive and could endure higher dosages and dosage rates. The female

gametes were irradiated just before fertilization and were pollinated with normal fresh pollen after irradiation. Like this, the structural aberrations had more chances to be involved in the fertilization process before restoration or elimination and transmitted to the next generation. These irradiated female gametes could be pollinated with mature and fresh pollen of normal wheat. This avoided the elimination of structurally aberrant chromosomes due to the fertilization competition mainly occurring in the male gametes, and a high proportion of the chromosome aberrations could be saved in the M_1 plants. A small fragment interstitial translocations with high powdery mildew resistance were identified in the back-crossing progenies by GISH and powdery mildew resistance evaluation.

As more disease resistance genes were cloned from model or other plant species, it was found that resistance genes were often present as a gene cluster in a specific chromosome region. By the development of alien translocation lines, more than one single useful gene can be introduced simultaneously without any safety issues brought by genetic modification. The translocation lines are genetically stable and their resistance is more durable compared with single-gene transfer. The wheat-rye 1RS/1BL translocation has been successfully utilized in breeding programmes worldwide, one important reason is that several useful genes, especially disease-resistant genes, are located in 1RS. More and more translocation lines, especially intercalary translocations with multiple useful traits will be used in modern wheat breeding with the accelerated development of various translocation lines involved in different alien species.

BIBLIOGRAPHY

- Chen, P.D., Liu, D. J. Identification of *Haynaldia villosa* chromosomes in alien wheat addition. In: Li ZS (ed) Proc 1st Int Symp on Chromosome Engineering in Plants, Xian, China, 31-33 (1986).
- Chen, P.D., Qi, L.L., Zhou, B. *et al.* Development and molecular cytogenetic analysis of wheat - *Haynaldia villosa* 6VS/6AL translocation lines specifying resistance to powdery mildew. *Theor Appl Genet* **91**, 1125-1128 (1995).
- Chen, P.D., Liu, W.X., Yuan, J.H. *et al.* Development and characterization of wheat-*Leymus racemosus* translocation lines with resistance to *Fusarium* Head Blight. *Theor Appl Genet* **111**, 941-948 (2005).
- Gill, B.S., Friebe, B., Endo, T.R. Standard karyotype and nomenclature system for description of chromosome bands and structural aberration in wheat. *Genome* **34**, 830-834 (1991).
- Liu, D.J., Chen, P.D., Pei, G.Z., Wang, X.N., Qiu, B.X., Wang, S.L. Transfer of *Haynaldia villosa* chromosomes into *Triticum aestivum*. In: Miller TE, Koeber RMD (eds) *Proc 7th Int Wheat Genet Symp*, Cambridge, UK, 355-361 (1988).
- Liu, W.X., Chen, P.D., Liu, D.J. Development of *Triticum aestivum* - *Leymus racemosus* translocation lines by irradiating adult plant at meiosis. *Acta Botanica Sinica* **41**, 463-467 (1999).
- Liu, W.X., Chen, P.D., Liu, D. J. Studies of the development of *Triticum aestivum* - *Leymus racemosus* translocation lines by pollen irradiation. *Acta Genetica Sinica* **27**, 44-49 (2000).
- Pei, G.Z., Chen, P.D., Liu, D.J. A cytogenetic analysis of some powdery mildew resistant strains of the hybrid progeny between wheat and *H. villosa*. *Journal of Nanjing agricultural University* **1**, 1-9 (1986).
- Sears, E. R. The transfer of leaf rust resistance from *Aegilops Umbellulata* to wheat. *Brookhaven Symp Biol* **9** (1956), 1-22
- Zhang, Q.P., Li, Q., Wang, X.E. *et al.* Development and characterization of a *Triticum aestivum* - *Haynaldia villosa* translocation lines T4VS.4DL conferring resistance to spindle streak mosaic virus. *Euphytica* **145**, 317-320 (2005).
- Zhang, P., Li, W., Friebe, B., Gill, B.S. Simultaneous painting of three genomes in hexaploid wheat by bac-fish. *Genome* **47**, 979-878 (2004).

Induced Mutation in Narrow-Leafed Lupin Improvement: An Example of Herbicide Tolerance

P Si^{1,*}, B Buirchell² & M Sweetingham²

Abstract

Spontaneous mutation has been discovered and utilized in domestication of narrow-leafed lupin (*Lupinus angustifolius* L.). As a result of domestication, lupin has become a dominant grain legume crop in Western Australia. Facing the new challenge of developing herbicide tolerant cultivars, chemical mutagenesis has been used to create new tolerance to herbicide. This paper reports the characterization of two lupin mutants (Tanjil-AZ-33 and Tanjil-AZ-55) that are highly tolerant to metribuzin herbicide. A dose response study of over eight doses revealed that Tanjil-AZ-33 was six times more tolerant to metribuzin than the original parental cultivar Tanjil, as measured by LD₅₀. This mutant Tanjil-AZ-33 is the most tolerant germplasm in narrow-leafed lupin. Both mutants also maintain the high resistance to the disease anthracnose as in cv Tanjil. Seed yield based on small field plots (3.6 m²) under irrigation was 4.2 t/ha for Tanjil-AZ-33 and 1.9 t/ha for Tanjil when the seedlings were subjected to 300 g/ha metribuzin at the six-leaf stage. Seed yields of both Tanjil-AZ-33 and Tanjil-AZ-55 were similar to Tanjil in absence of the herbicide. These facts indicate that the mutation process has created tolerance to metribuzin in Tanjil, without altering its yield capacity and anthracnose resistance. The mutant Tanjil-AZ-33 has been used as a parent in the lupin breeding programme and we expect future lupin cultivars to have increased metribuzin tolerance. Induced mutation proved to be an effective tool in lupin improvement.

Introduction

Narrow-leafed lupin (*Lupinus angustifolius* L.) is a wild native species of the Mediterranean region that has become a major grain legume crop in Australia since the release of the first sweet cultivar Uniwhite in 1967. Domesticating the plant for modern agriculture involved discovery and utilization of spontaneous mutants of several key domestication genes [1]. For example, Uniwhite contains natural mutants of non-shattering, low-alkaloid and soft-seed genes. The early flowering mutant *Ku* gene, present in cv Unicrop released in 1973, brought flowering forward by two to five weeks and allowed narrow-leafed lupin to be grown as a successful commercial crop in the Mediterranean climate of Western Australia [2]. Most cultivars released after Unicrop have disease resistance in addition to these domestication genes.

Under the current lupin production system in Australia, the top agronomic issues are weed and disease management control. Cultivars with increased tolerance to herbicides are needed to expand weed management options in the minimum tillage farming systems. The anthracnose resistant cultivar Tanjil has been widely used as a parent in the lupin breeding programme in Australia as a source of anthracnose resistance. Unfortunately, it was found to also be sensitive to metribuzin herbicide

[3]. Therefore, improving tolerance to metribuzin in progenies containing Tanjil parentage has become very important.

One approach to improve tolerance to metribuzin in Tanjil is to create it through chemical mutagenesis. Mutants induced from cv Tanjil have been selected for metribuzin tolerance and several mutants were found to be highly tolerant to metribuzin [4]. This paper reports the characterization of two highly tolerant mutants in terms of LD₅₀, seed yield in the presence and absence of metribuzin application, and anthracnose resistance in the disease nursery.

Materials and Methods

Two metribuzin tolerant mutants Tanjil-AZ-33 and Tanjil-AZ-55 [4], along with the metribuzin-sensitive cv Tanjil (the original parent of the mutants) and the metribuzin tolerant cv Mandelup were examined in a dose response study involving eight doses, four replicates and 20 plants per replicate. Experimental procedures were the same as reported in [3].

The two mutants were compared with cultivars Tanjil and Mandelup for seed yield when 300 g/ha metribuzin was applied to seedlings at the six-leaf stage with boom spray fitted on a motorbike with output of 72 L/ha. Metribuzin at 300 g/ha was applied on July 7, 2006 to six to eight leaf stage lupin plants. Herbicide damage was scored at three weeks after spray. Plants were grown in 3.6 m² (1.5 x 2.4) plots sown at 50 seeds/m². Plants of each plot were harvested by hand at maturity and seed yield obtained.

For seed yield measured in the absence of metribuzin at regional sites, trial preparation and management was the standard of field evaluation of breeding materials by the lupin breeding programme at the Department of Agriculture and Food of Western Australia.

Assessment of anthracnose resistance was conducted in the irrigated disease nursery at the Medina Research Station, Western Australia in 2006 and followed the same protocols as used for all the breeding materials from the lupin breeding programme.

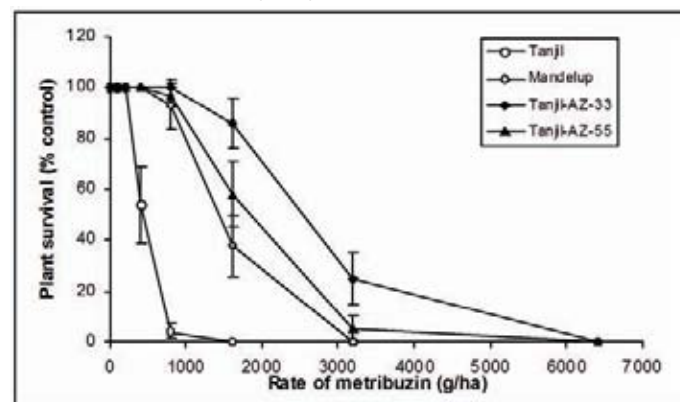

Figure 1 Percentage of plant survival of induced mutants Tanjil-AZ-33 (◆), Tanjil-AZ-55 (▲) compared with original parent cv Tanjil (○) and a tolerant cv Mandelup (◇) in metribuzin dose responses with plants grown in a 20/12°C (day/night) phytotron.

¹ Center for Legumes in Mediterranean Agriculture, Faculty of Natural and Agricultural Sciences, The University of Western Australia, 35 Stirling Highway, Crawley, 6009, Australia.

² Department of Agriculture and Food of Western Australia, Locked Bag No. 4, Bentley Delivery Center, WA 6983, Australia

* Corresponding author. E-mail: pingsi@cyllene.uwa.edu.au

Results

Dose response

At high herbicide rates (Fig. 1), mutants Tanjil-AZ-33 and Tanjil-AZ-55 had a greater percentage of survival than the wild type Tanjil. At the metribuzin rate of 800 g/ha, all Tanjil plants died whilst the mutants survived at 100%. The difference by LD₅₀ between the mutant Tanjil-AZ-33 and Tanjil was six-fold. The mutant Tanjil-AZ-33 had much higher survival than Mandelup at rates greater than 1600 g/ha, suggesting a tolerance even greater than that of cv Mandelup.

Seed yield in the presence of metribuzin

Seed yield of mutant Tanjil-AZ-33 was 4.23 t/ha under irrigation, more than twice that of Tanjil when they were subject to metribuzin at 300 g/ha during the six to eight leaf stage, but very close to that of the tolerant cultivar Mandelup (Table 1). Both mutants showed no symptoms of leaf damage from metribuzin at three weeks after application whilst Tanjil plants were severely damaged.

Table 1. Seed yield of metribuzin tolerant mutants subject to 300 g/ha metribuzin in the field at Shenton Park in 2006.

Genotype	Seed yield (t/ha)	Visual damage score against metribuzin ^A
Tanjil-AZ33	4.23	0
Tanjil-AZ55	2.62	0
Tanjil	1.86	3
Mandelup	4.63	0
Lsd. (P<0.05)	1.19	

^A Damage score against metribuzin with 0=no symptom, 3=most plants had scorch on first six leaves and 5=plant dead.

Seed yield in the absence of metribuzin

Seed yield of the two mutants Tanjil-AZ33 and Tanjil-AZ55 in the Stage 2 field evaluation (in the absence of metribuzin) was not significantly different ($P < 0.05$) from that of Tanjil at three regional locations in Western Australia in 2006 (Table 2), although the actual seed yield varied from location to location. Mandelup had significantly higher yield than the two mutants at the sites of Merredin and Wongan Hills.

Anthracnose resistance

The visual scores of resistance to anthracnose of the mutants Tanjil-AZ 33 and Tanjil-AZ 55 were not significantly ($P < 0.05$) different from those of Tanjil in the disease nursery in 2006 (Table 2), suggesting a similarly high resistance to anthracnose. The mutants had slightly higher scores than cv Mandelup.

Table 2. Anthracnose resistance and seed yield (t/ha) of mutant lines in the absence of metribuzin at regional sites in 2006.

Variety	Variety Anthracnose resistance score ^A	Badgingarra	Merredin	Wongan Hills
Mandelup	6.0	1.14	1.38	1.52
Tanjil	7.0	1.08	1.12	1.29
Tanjil-AZ-33	6.8	1.05	1.01	1.26
Tanjil-AZ-55	7.0	0.99	0.99	1.27
Lsd (P = 0.05)	1.0	0.34	0.32	0.22

^A Disease resistance was evaluated in disease nursery at Medina Research Station in 2006. 1=plants severely damaged, 9=plants immune.

Discussion

Two mutants induced from the metribuzin-sensitive Tanjil are highly tolerant to metribuzin, with a six-fold increase in tolerance to metribuzin compared to the original parent Tanjil as revealed by the dose response study, thus confirming that induced mutagenesis is a useful breeding tool to develop tolerance to herbicides. Mutation breeding has been successfully used in soybean for an increased tolerance to sulfonylurea herbicide [5]. The mutant Tanjil-AZ-33 has even greater tolerance to metribuzin than the tolerant cultivar Mandelup. Mandelup was released in 2004 as a high-yielding, early-flowering cultivar tolerant to metribuzin in the field at recommended rates. The degree of metribuzin tolerance in Mandelup is similar to other tolerant cultivars [3]. Tanjil-AZ-33 is the most herbicide tolerant genotype in the lupin germplasm collection. This, in fact, indicates that mutation created new tolerance. Mutants with tolerance better than Mandelup are valuable sources for the development of lupin cultivars with greater tolerance. Tanjil-AZ-33 has been used as a parent as a source of metribuzin tolerance in the breeding programme.

Cultivars with greater tolerance would lead to greater safety margin to this herbicide and could potentially lead to higher application rates to allow better weed control. When 300 g/ha metribuzin was applied to seedlings at the six-leaf stage, tolerant mutants had no symptoms of foliage damage whilst Tanjil seedlings were severely scorched. Consequently, seed yield of Tanjil-AZ-33 was twice that of Tanjil in presence of metribuzin, even though seed yield potential of the mutants is similar to Tanjil in absence of metribuzin as tested in the Stage 2 field trials across three locations. Seed yield of Tanjil-AZ-55 was lower than Tanjil-AZ-33, largely due to the observed damage caused by thrips during flowering. Mandelup yielded higher than Tanjil and the two mutants in the Stage 2 field trials. However, seed yield of Tanjil-AZ-33 was comparable to Mandelup at 300 g/ha metribuzin. It is expected that new cultivars combined with the high yielding background of Mandelup and high metribuzin tolerance of Tanjil-AZ-33 would be able to tolerate higher herbicide rates and coupled with a greater safety margin and hence higher yield.

The two mutants Tanjil-AZ-33 and Tanjil-AZ-55 were selected among several other tolerant mutants on the basis of their carrying the molecular marker of anthracnose resistance gene [4]. Presence of the specific molecular marker for Tanjil's resistance to anthracnose in all seedlings of the two mutants suggests that these mutants retained the anthracnose resistant gene [6]. We hoped that some mutants would retain the anthracnose resistance of Tanjil but also show an improvement in the tolerance to the herbicide. Anthracnose resistance screening in the disease nursery confirms that both mutants are as highly resistant to anthracnose as Tanjil.

In conclusion, induced mutagenesis has created two new mutants highly tolerant to metribuzin, but has not altered the characteristics of Tanjil in yielding capacity and anthracnose resistance. The induced mutant Tanjil-AZ-33 has replaced the original parent Tanjil as parental source for both anthracnose resistance and metribuzin tolerance in the lupin breeding programme. Mutation breeding will continue to provide genetic variation for the improvement of lupin required to adapt to the changing farming systems.

ACKNOWLEDGMENTS

This research is funded by Grains Research and Development Corporation. We are grateful to John Quealy and the lupin breeding staff at DAFWA for their technical support.

BIBLIOGRAPHY

1. Cowling, WA. Huyghe, C., Swiecicki W. Lupin breeding. In: Lupins as Crop Plants, Biology, Production and Utilization. 93–120, Eds: Gladstones, Atkins and Hamblin. CAB International, UK (1998).

2. Gladstones, J.S., Hills. Selection for economic characters in *Lupinus angustifolius* and *L. digitatus*. 2. Time of flowering. *Australian Journal of Experimental Agriculture and Animal Husbandry* **9**, 213 -220 (1969).
3. Si, P. Sweetingham, MW. Buirchell, B. Bowran, D., Piper T. Genotypic variation on metribuzin tolerance in narrow-leaved lupin (*Lupinus angustifolius* L.). *Australian Journal of Experimental Agriculture* **46**, 85-91 (2006a).
4. Si, P. Sweetingham, M. Buirchell, B., Yang H. Lupin mutants highly tolerant to metribuzin. Proceedings of 13th Australian Plant Breeding Conference, 18-21 April 2006, Christchurch, New Zealand. C.F.Mercer (ed), 326-329 (2006b).
5. Sebastian, S.A., Chaleff, R.S. Soybean mutants with increased tolerance for sulfonylurea herbicides. *Crop Science* **27**, 948-952 (1987).
6. You, M., Boersma, J.G., Buirchell, B.J., Sweetingham, M.W., Siddique, K.H.M., Yang, H. A PCR-based molecular marker applicable for marker-assisted selection for anthracnose disease resistance in lupin breeding. *Cellular and Molecular Biology Letters* **10**, 123-134 (2005).

Results of Utilization of Chernobyl Radio Mutant in Breeding Programmes of *Triticum aestivum* L.

L A Burdenyuk-Tarasevych

Abstract

A large spectrum of mutations was observed as a result of winter wheat *T.aestivum* L. irradiation for two consecutive vegetative seasons (during 1986-87) in the fields close to the ruined reactor of the Chernobyl Nuclear Power Station. Mutants taken from the different generations (L147/91, BC 47 square head, dwarf 20104/89) were used for development of the varieties Lybid, Yasochka and Tsarivna to utilize traits from the mutants such as hardiness, drought tolerance, disease and lodging resistance and bread quality. These varieties were included in the State Variety Register of Ukraine, while another one, Lisova Pisnya is included in the list of perspective varieties.

Introduction

The genetic changes in winter wheat that occurred due to the ionizing radiation, which appeared as a result of Chernobyl Nuclear Power Plant accident, were investigated during 1988-2007 at the research station in Bila Tserkva. Irradiation received by plants was chronic. External gamma-irradiation, internal irradiation, irradiation by beta and alpha particles from incorporated radionuclide formed a cumulative incorporated doze. [1] 239 accessions of common wheat, which during two years in plantations in 1986 and in self-sowing 1987, grown near the Chernobyl Reactor were picked up by academician D.M. Grodzinsky, and professors P.K. Shkvarnikov and V.F. Batygin, who kindly provided them to our station for further investigation and analysis. The objective was to assess their possible utilization in breeding by selecting among them the mutants with attractive agronomic important traits to be subsequently introduced in breeding programmes. Another goal was to identify the remote consequences of the irradiation, which may later be used to forecast genetic changes for numerous populations remaining in the zone polluted by the radionuclide. [2]

Results and Discussion

The four varieties of common wheat, Bilotserkivska 47, Poliska 70, Myronivska 808 and Kyianka were planted at the fields of Chernobyl area before the accident. Even in M_3 , a large spectrum of mutations was discovered. Because of genetic instability, the mutant diversity increased each year and, to date, the collection includes up to 2,000 mutants. [3] Plants with different kinds of abnormalities in structure appeared among mutants of different generations. We called them chimerical plants and they had no value for breeding. Moreover, the direct selection from mutants of all studied varieties did not yield positive results due to the high instability of all characteristics in many generations. This was particularly true for the segregation in plant height and morphology observed as well as for yield and gluten quality.

At the same time, several selected lines of mutants that showed some advantageous agronomic characteristics, were applied to the breeding

programmes. The first one was Mutant 20168/89, where even in M_3 segregation was observed in the progeny of seeds collected from one ear: 54% of plants had square head ear with awns, a stem height 90-105cm and were resistant to brown rust, whereas 46% of plants closely resembled Myronivska 808 - lyutestsens sub-variety, with a stem height of 116cm and were highly susceptible to lodging and brown rust.

In M_4 , a heterozygous ear mutant of Lyutestsens 147 (L147) was selected. The segregated population from this mutant (M_5) exhibited 89% awnless plants with a normal ear density, 10% of plants appeared to be square head form and 1% of plants were small chimeras with a height of 25cm. A separate segregation by height was also observed simultaneously, with variation between 75 and 110cm. Genetic instability of Mutant 20168/89 was also observed in later generations. (Fig. 1)



Figure 1 Splitting of genetically unstable mutant – 20168/89 in later generations (M6-M12): 1 – Lyutestsens with normal ear density L147/91, which became the female parent in the creation of Lybid and Yasochka; 2 – compactoid semi-awned with twisted ear stem; 3 – “transparent” ear without ear stem, with spikelets attached to each other; 4 – ear with deformed awns and sterile upper part; 5 – awnless squared head; 6 – well developed awned squared head with noticeable changes in the middle of the ear.

In M_6 , the segregation of L147 continued by ear morphology and plant height. In this population the constant mutant L147/91 was selected, awnless and with high resistance to brown rust, septoria and *Fusarium* spp., because of which the plants have green leaves during all stages of ripening. This mutant has high gluten content in seeds – up to 41-48%, coupled with low quality of this gluten.

Further, mutant L147/91 with normal awnless ear was selected as a female component for crossing with the strong common wheat variety Novoukrainka Bilotserkivska. This was aimed at decreasing height and increasing thickness of the stem of cv. Novoukrainka Bilotserkivska while simultaneously improving its resistance to a number of diseases.

An F_2 population of 2,000 plants from those progenitors was studied and 105 among them were collected and sown. In the F_3 population from those plants, 23 families were selected for control nursery. Such lines were highly productive, winter-resistant (especially in winter conditions

with snow) as well as lodging-resistant, and they had high gluten content of good quality. Therefore, in this crossing the low gluten quality derived from mutant L147 was inherited as a recessive trait and the level of gluten content as heterozygous.

Line № 728/98, which was selected for further investigation in control nursery, was registered in Ukraine in 2006 as variety Lybid' and recommended for cultivation in all zones of Ukraine. This variety is awnless, with an intermediate date of ripeness, high winter resistance (it successfully passed the 90-days of ice crust winter condition in 2003), drought tolerant, has resistance to brown rust, powdery mildew and septoria. It is a semi-dwarf, highly productive variety and belongs to the strong wheats. A maximum productivity of 9.6 t. per hectare was achieved by Bila Tserkva State Variety Testing Station (SVTS) of Kiev State Center for Plant Variety Expertise (CPVE) during the very dry 2007 season, which superseded the standard variety Podoliianka by 0.9 t. per hectare.

Mutant L147/91 was also successfully used as female parent with variety Napivkarlyk 3 crossing, resulting in the creation of variety Yasochka. Unlike regular crossings with stable varieties, splitting by awn trait was recorded immediately in F₁; crossing of two awnless parental forms generated 1% of awned offspring. A wide variety of recombinants was also observed in further generations. There were 56 hybrid lines studied in F₃ with 14 selected for the control nursery. A wide variability was obtained, both morphologically and for traits useful in breeding.

Thus, the variation in the control nursery for winter resistance ranged from three to four (on a five-point scale); brown rust resistance ranged from 2% to 65%, yield from 5.4 to 7.4 t. per hectare, stem height from 90 to 100cm, gluten content from filler with Gluten Deformation Index (GDI) of 113 to strong wheat with 15% of protein and GDI of 78. The difference in ripening season reached 10 days. The most productive line from this crossing, 199/02, was included after the state variety testing in the State Plant Variety Register for 2006 as Yasochka variety. Yasochka is awned, of mid-size height and mid-term ripening. It has a high drought tolerance, above average winter resistance and big kernels, having inherited resistance to brown rust, septoria, *Fusarium* spp. and lodging from mutant L147/91. Gluten quantity was also inherited from the mutant L147/91 with no connection to gluten quality. As a result, the variety was classified among strong wheats by gluten. A maximal yield of 8.5 t per hectare was achieved in 2004 in Vinnytsa CPVE and 8.4 t per hectare in Dnipropetrovsk CPVE. Yasochka is recommended for cultivation in the Steep-forest region.



Figure 2 Mutants of Bilotserkivska 47 common winter wheat. 4 – parental variety Bilotserkivska 47, 20035 – mutant of Bilotserkivska 47 – female form in crossing led to development of varieties Tsarivna, Lisova Pisnya and Romantica.

In the collection of Chernobyl mutants the most numerous and least stable are a group of mutants of Bila Tserkva 47 – BC 47 squared head (BC 47 sqr). In M₃ they differ from the original variety by thicker upper half of the ear, meaning they possess a squared head ear. In 1989, there were 40 families of such mutants, with 25% of them awned and of even height. Others got split by height from 85 to 105cm, different morphological traits of the ear stem and leaves. In different generations different systemic mutations were noted. They possessed traits of other species: *T.spelta* (L.), *T.compactum* (Host) and *T.vavilovi* (Tum. i Jakubz). [4] All of them, like the original genotypes, belong to hexaploid wheat. Some mutations had no noticeable morphological differences but had different quantitative traits such as productivity, bread quality, winter resistance, disease resistance etc., of practical application for breeding. For their identification, analysis of useful traits was conducted along with the study of morphological changes, whereby mutant BC 47 sqr. # 774/89 (Fig. 2) was selected.

Unlike many other mutants in this group (Fig. 3), BC47 had no significant deviations from normal ear structure with an exception of hardly noticeable square head and doubled spikelets on some parts of the ear. In addition, during nine years of testing (1991-1999), BC 47 sqr. has proven to be winter-resistant and of high bread quality. After multiple selections by pedigree method, BC 47 sqr. became more stable and was introduced for crossing with a steppe ecotype variety, Odesska 162, to improve winter resistance of the latter. After multiple selections from the progeny, three selected lines became new varieties: Tsarivna (included in the State Registry in 2008), and Lisova Pisnya and Romantica (included in 2009). Romantica variety is presently under state testing. All three varieties were found to be winter-resistant when tested in freezers, classified as belonging to the strong wheat group, and having high productivity. Maximal productivity of Tsarivna variety is 8.8 t. per hectare, while 9.0 t. per hectare was achieved with Lisova Pisnya in the Variety Study Centre in Kiev region in 2006.



Figure 3 Splitting of genetically unstable mutant of Bilotserkivska 47 in M₉: 9.- spikelets after threshing; 11.- *T. spelta*; 10,12- *Spelta-Compactum*; 14- spikelets are on a single side of ear stem.

Varieties obtained from crossing with radio mutants are characterized by high drought tolerance. In dry 2007 in Steppe region (Kirovograd Testing and Breeding Station), Tsarivna yielded 8.3 t per hectare and Lybid yielded 8.5 t. per hectare, which is higher than the standard variety Podolyanka by 0.9 and 1.1 t. per hectare, respectively. In the marshy woodlands zone at Borodianska Testing and Breeding Station, Lisova Pisnya delivered 6.2 t per hectare, outperforming Podolyanka by 2.8 t per hectare.

Another mutant, dwarf 20104/89, was found to be a prospective parent for future selection. In M₃, it was heterozygous by many traits, the progeny obtained from one ear having a height ranging from 48 to 76cm, with compactum-type short ear. In the upper part of the ear many

spikelets had sterile flowers. In M_4 and M_5 , the splitting continued with square headed, awned and awnless forms, tall and dwarf plants, early and late ripened plants. In M_6 a dwarf plant (60cm tall), with a strong stem and good ear density, but with low productivity was selected, and was introduced for breeding with the good bread-making quality variety Novoukrainka Bilotserkivska, which was susceptible to lodging. Transgression by productivity was obtained as a result. In the control nursery 24 numbers out of 63 surpassed the productivity of the original variety. The most productive lines achieved 7.7-7.8 t per hectare. They were resistant to lodging and to brown rust belonging to strong wheats. The best line, named Vidrada, was taken for the state testing. From dwarf mutant 20104/89 it inherited strong stem and quality of the strong wheat.

Thus, disease resistance (L 147/91), lodging resistance (20104/89), drought tolerance and winter resistance traits (BC 47 sq.), plus gluten content and gluten quality (20104/89 and BC47 sq.) were utilized for breeding. The use of stable (after multiple selections) lines of Chernobyl mutants as parental genotypes in crosses enhanced the genetic pool of winter wheat and helped to develop highly productive varieties with good bread-baking qualities and increased adaptive potential for hostile environments.

BIBLIOGRAPHY

1. Viktorova, N., Grodzinsky, D., Physical And Chemical State Of Fuel Particles And Radionuclide Infiltration Into The Plants. – In Book: Radiation Aspects Of Chernobyl Accident Part 2, p.54-60 (1989) (In Russian).
2. Grodzinsky, D. *et al.* Anthropogenic radionuclide anomaly and plants. *Kiev Lybid*, p.157 (1991) (In Russian).
3. Grodzinsky, D., Kolomiets, O., Burdenyuk, L. Collection of Chernobyl mutants of winter wheat. *Kiev*, p.29 (1999) (In Russian).
4. Burdenyuk-Tarasevych, L. Formation of systemic mutations of winter wheat as a consequence of radioactive irradiation of *Triticum Aestivum* in the Chernobyl power station exclusion zone. In: Factors of Experimental Evolution of Organisms. Ukrainian society of genetics and plant breeders named after Vavilov. *Kiev*, p.339-344 (2006) (In Ukrainian).

Sunflower Mutants with Improved Growth and Metal Accumulation Traits Show a Potential for Soil Decontamination

E Nehnevajova^{1,2,*}, R Herzig², J-P Schwitzguébel³ & T Schmölling¹

Abstract

Over the last two decades, the use of plants has been proposed as an alternative technique to remove toxic metals from contaminated soils. This technique, called phytoextraction, can use either hyperaccumulating species, able to accumulate and tolerate high amounts of metal, but producing low biomass, or high-yielding crops compensating moderate metal accumulation by a high biomass. Both types of plants can be considered for metal removal, but soil decontamination still takes quite a long time. Therefore, plants used for metal removal need to be improved.

This paper summarizes our previous and present work aimed at the improvement of sunflowers for phytoextraction by chemical mutagenesis. Improved yield and metal accumulation in sunflower mutants were already observed in the M₂ mutant generation, where three new sunflower phenotypes were found: mutants with a significantly enhanced biomass production and no changed metal accumulation; mutants with a slightly improved biomass production and an enhanced metal accumulation in shoots; and mutants with reduced metal uptake. The same alterations in growth and metal accumulation were observed in the following generation. The best M₃ sunflower mutants showed a three to five times higher cadmium, a four to five times higher zinc, and a three to five times higher lead extraction, as compared to the control inbred line. The stability of improved traits, yield and metal uptake, was confirmed also in the fourth generation, where mutant lines still provided a significantly enhanced metal extraction.

Metal translocation from root to shoot and distribution within the shoot (stem, leaves and flower) of mutant lines and control sunflowers grown on a metal contaminated soil was studied in detail in the fifth generation under greenhouse conditions. Sunflower mutant seedlings show a very good metal translocation capacity after three months of cultivation on contaminated soils; thus the metals were primarily accumulated by sunflower leaves.

Introduction

Soils contaminated with metals (such as cadmium, chromium, nickel, zinc, lead, etc.), arsenic, and various radionuclides are nowadays a major environmental and human health problem. Main sources of soil contamination are the metal smelting industry, residues from metalliferous mining, combustion of fossil fuel, sewage sludge, waste incineration, car exhausts as well as some pesticides and fertilisers used in agriculture. In the European Union, more than 16% of the total land area, an estimated 52 million hectares, is affected by some level of soil degradation [1]. In contrast to the organic contaminants, which can undergo biodegradation, heavy metals cannot be destroyed and remain in the environment. Moreover, they can enter the food chain via agricultural products or

leach into drinking water. Therefore, there is a need for an effective and affordable technological solution for soil remediation.

Nowadays, phytoremediation is becoming very popular as a novel strategy to clean up polluted soils. This decontamination technique needs green plants and their associated micro-organisms, soil amendments and agronomic techniques to remove, contain or render harmless environmental contaminants [2, 3]. A great scientific and commercial interest now focuses on a phytoremediation strategy called phytoextraction. It is based on the ability of plants to take up, transport and concentrate metals from the soil into the above-ground parts of plants [3, 4]. Plants used for phytoextraction have to be finally harvested, then disposed or converted into valuable products. The main advantage of metal phytoextraction is *in situ* application without further disturbance of the site. Another advantage is a lower cost than conventional methods to decontaminate land. The possible recycling of metals and recovery of bioenergy could provide further economic advantages of phytoextraction. One of the possible limitations of this method is that its applicability is restricted to the upper soil layers and low or moderately contaminated soils [5]. The greatest disadvantage of metal phytoextraction is the need of a long cleaning up time. The phytoextraction process should preferably not exceed a few decades [6, 7]. The interest of many scientists is thus focused on a reduction of time needed for phytoextraction.

Based on long years of experimentation, two groups of plants are considered to be useful for metal phytoextraction: (1) hyperaccumulator species (e.g. *Thlaspi caerulescens* L., *Arabidopsis halleri* L.) which can accumulate and tolerate metals that are toxic to other organisms even at low dosage [8, 9], but produce low biomass; and (2) high biomass producing species, like *Helianthus annuus* L. [10, 11]. Although these plants are among the best candidates for phytoextraction, they are still not efficient enough to remove sufficient amounts of metals from the soil within 10 years. For a practical use of this green technology, it is necessary to enhance phytoextraction efficiency.

Phytoextraction efficiency can be enhanced either at the level of soil, using fertilizer and chelating agents to enhance metal bioavailability [12, 13] or at the plant level, improving insufficient metal uptake characteristics of high yielding crops or increasing the biomass of hyperaccumulators. The main attention of improvement of phytoremediation technology is focused on the achievement of high shoot metal concentration in high-yielding plants [14]. Genetic engineering as well as traditional breeding (classical mutation and *in vitro* breeding techniques) may help to improve the existing insufficient capacity of the metal phytoextraction by high-yielding crop species [15, 16, 17].

This paper gives an overview about the possible use of chemical mutagenesis to improve the capacity of sunflowers for metal uptake, accumulation and removal.

Mutagenesis as a tool to improve metal tolerance and metal accumulation by plants

Mutation techniques have contributed significantly to world-wide plant improvement, including yield, oil quality, disease, salt and pest resist-

¹ Institute of Biology/Applied Genetics, Free University of Berlin, Albrecht-Thaer-Weg 6, D-14195 Berlin, Germany.

² Phytotech-Foundation (PT-F), Quartiergasse 12, 3013 Berne, Switzerland

³ Swiss Federal Institute of Technology, Laboratory for Environmental Biotechnology (LBE), EPFL Lausanne, Switzerland

* Corresponding author. E-mail: nehnevaj@zedat.fu-berlin.de

ance in crops. According to the FAO/IAEA Mutant Varieties Database, more than 1840 mutant varieties involving 164 plant species have been officially released up to December 1997 and some of them have made an outstanding impact on the productivity of a particular crop [18, 19]. In some countries mutant varieties of economically important crops, e.g., barley, durum, wheat and cotton occupy the majority of cultivated areas. Mutation techniques have also been successfully used for the induction of Al tolerance in wheat [20] and barley [21, 22]. Based on the fact that ionizing treatments and also certain chemical mutagens could induce a lot of useful alterations in the genome of crop plants, artificially induced mutations might lead as well towards crop improvement of metal accumulation.

Chemical mutagenesis has already been used to obtain new mutant variants with enhanced metal accumulation traits. Mutant seedlings of *Arabidopsis thaliana* L. accumulate a 7.5 times higher amount of manganese and 4.6 times more copper from the soil than the control [23]. Zinc accumulation is enhanced by a factor of 2.8 and magnesium by a factor 1.8 in the mutant variants. It was found that this recessive mutation shows a positive correlation with ferric-chelate reductase activity. Two cadmium-tolerant mutants, initially assessed by root growth, have been isolated from ethyl methanesulphonate (EMS) mutagenised *Arabidopsis* seeds. One mutant, *cdht1*, shows an LD₅₀ of 200 µM Cd versus an LD₅₀ of 110 µM Cd for the control plants. The mutants *cdht1* and *cdht4* accumulate 2.3 times less cadmium than control plants exposed to 150 µM CdCl₂ [24]. Induced mutations have also been used for rapid creation of variability in Al tolerance in barley. Thirteen mutants with increased levels of tolerance to Al have been selected in the M₃ generation after mutagenic treatment of four barley varieties with N-methyl-N-nitroso urea and sodium azide (NaN₃) [21]. An enhanced aluminium (Al) tolerance has also been observed in barley cell lines obtained through mutagenesis by EMS, sodium azide and Gamma-rays [22]. The chemical mutagen EMS has also been used recently to improve metal uptake and accumulation properties in *Helianthus annuus* L. [25].

Mutagenesis of sunflowers to improve metal uptake, accumulation and extraction capacity

Over the last 40 years, mutagenesis has played an important role to improve agronomic characteristics of *Helianthus annuus* L., one of the most important oil seed crops in the world. An increased variability in the fatty acid composition in oil of sunflower mutants, obtained from seeds mutagenized with EMS has been reported [26]. Chandrappa [27] has obtained new sunflower mutants with enhanced oil content and enhanced biomass production after mutagenesis with EMS or DES (diethyl sulphate). In another study [28], sunflower mutants of M₂ and M₃ generations with high linoleic acid content for diet food and mutants with high oleic acid content for special purposes like frying oils after EMS mutagenesis were developed and characterized.

New sunflower variants promising for phytoextraction have been developed by means of chemical mutagenesis by [25] and tested on a metal-contaminated field in Switzerland. Sunflower seeds (about 8,000) of inbred lines have been treated with 0.08 M EMS for 5 h. Mutagenised seeds have been directly sown out on a sewage sludge contaminated field with total metal concentrations of 0.9 Cd, 813 Zn and 492 Pb mg/kg dry weight [25].

Sunflower mutants of the M₁ and M₂ generations have been cultivated under free-land conditions to assess the effect of mutagenesis on yield, metal accumulation and extraction characteristics by sunflowers on metal-polluted soil. The mutant screening was done in the second generation, where 320 mutants were investigated. Results of cadmium, zinc and lead shoot concentrations in the tested mutant plants showed three phenotypes: 1) mutants with a significantly enhanced biomass, but no changed metal tissue concentration; 2) mutants producing a higher biomass with an enhanced metal concentration; and 3) mutants with a

reduced metal concentration (exclusion) in the shoots, potentially interesting for improving food safety [25]. Biomass production and the ability of metal shoot accumulation in plants are two key factors for an efficient phytoextraction. Metal extraction (metal accumulation x dry weight) was thus the main criterion for sunflower mutant screening in the field experiments. In the M₂ generation the best sunflower mutant showed a strongly enhanced metal extraction, as compared to the control plants: Cd 7.5 x, Zn 9.2 x and Pb 8.2 x [25]. Ten individual M₂ lines with the significantly increased biomass and ten individual M₂ lines with improved biomass and an enhanced metal shoot accumulation were selected for a further study. Descendants of these mutant clones are termed M₃ and M₄ generation. To study the distribution and stability of the selected traits we analyzed individual descendants of these 20 lines and present here the overall results for the whole population without considering the individual mutant families.

The next two generations of sunflower mutants (M₃ and M₄) were grown on the metal-contaminated field to study the stability of improved yield and metal uptake traits. In the third and fourth generations, these sunflower mutants also produced a significantly higher biomass leading to an improved metal extraction than the control inbred line (Fig. 1). The best individual M₃ sunflower mutants of particular lines showed a three to five times higher cadmium, a four to five times higher zinc, and a three to five times higher lead extraction as compared to the non-mutagenized sunflowers. The most interesting M₃ sunflowers were self-pollinated and tested for their metal removal efficiency in the fourth generation. The improved growth and metal accumulation/extraction characteristics were assessed for each mutant clone individually to study the stability of the trait or the possible heterogeneity between sunflowers originating from the same mutant line. Results showed that the mutant lines kept the improved traits of yield and metal extraction. The following enhancement of metal extraction by mutants was found in the M₄ generation: cadmium three to four times, zinc five to seven times, lead six to eight times and chromium five to seven times higher than control sunflowers [29].

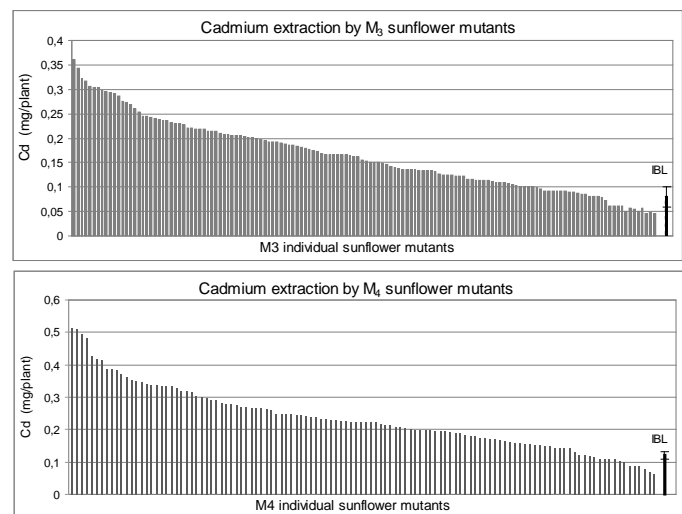

Figure 1 Cadmium extraction by individual sunflower mutant progenies of the third and fourth generation and inbred line (IBL).

We found that EMS mutagenesis mainly led to an enhanced shoot biomass and consequently an improved metal extraction. The capacity of metal accumulation in the shoot was also partially improved.

The phytoextraction potential of sunflower mutants and control sunflowers was calculated per hectare and year. Results obtained from three field experiments show that sunflower mutants can produce up to 20.9

t dry matter per ha and year and remove 10-11 kg Zn and 16-25 g Cd per ha and year from the metal contaminated field. In contrast, control sunflower IBL 04 produced only 4.1 t dry matter per ha and year, with the following metal removal: 4.8 g Cd, 2.2 kg Zn per ha and year [29].

Thus, sunflower mutants obtained during this study show a high potential for the removal of zinc and also of cadmium, as compared to the metal extraction efficiency by other sunflower cultivars, tobacco, maize or even by the hyperaccumulator *T.caerulescens*. For example, for zinc it was significantly higher than reported for other sunflower plants [30], where zinc removal is only 2 kg per ha and year.

As already mentioned, a sufficient metal shoot concentration and biomass production are key factors for the practical use of phytoextraction. Due to this fact, the next objectives of our research were aimed at the assessment of the metal translocation capacity of these new sunflower mutant lines. Descendants of M_2 lines with improved metal accumulation in shoots and biomass were grown in a greenhouse on a metal-contaminated soil with 10 mg/kg cadmium and 1110 mg/kg zinc in the M_5 generation. Cadmium and zinc concentrations in roots and shoots were measured after three months of growth on the polluted soil. Moreover, several growth parameters, such as shoot and root dry weight, were evaluated in sunflower lines cultivated on non-contaminated soil and polluted soil to assess the effects of cadmium and zinc on plant growth and productivity. We observed a growth reduction of both non-mutagenized inbred line and sunflower mutants on the metal contaminated soil, as compared to non-contaminated soil. But no other symptoms of cadmium and zinc toxicity were observed on the polluted soil. However, M_5 sunflower mutants still produced a higher shoot and root biomass on the metal contaminated soil compared to the inbred line. Leaves of the mutant line exhibited a 2.3 times higher cadmium and a 2.5 times higher zinc extraction than the inbred line; mutant roots with a 1.5 times higher dry weight showed a 1.6 times better cadmium and a three times better zinc extraction than the non-mutagenized line (Fig. 2).

Sunflowers of the mutant line also showed a better root development compared to the inbred line. This root enhancement can lead to improved access to water, minerals, as well as toxic metals. Therefore, plants with a well-developed root systems are potentially very useful for phytoextraction.

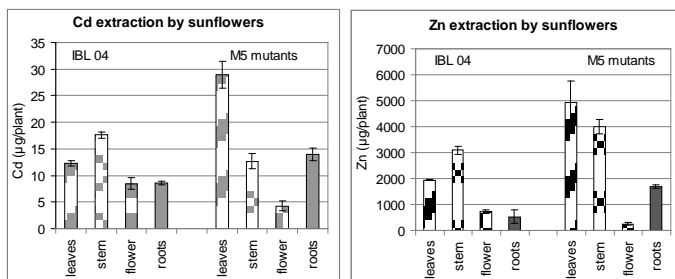

Figure 2 Cadmium and zinc extraction by leaves, stem, flower and roots of sunflowers tested on a metal-contaminated soil in the greenhouse.

The metal concentration was determined in the control inbred line IBL04 and sunflower mutants of the fifth generation after three months of growth on polluted soil.

Conclusions

Sunflower mutant lines obtained after chemical mutagenesis showed in four successive generations (M_2 - M_5) an improved metal removal capacity. Due to the results obtained from field and greenhouse experiments, we can conclude that classical mutagenesis has a great potential to generate lines with enhanced metal extraction properties. It is thus still a valuable alternative to genetic transformation. Important advantages of

this non-GMO approach for practical phytoextraction are the absence of restrictions for field tests and the direct use of new improved varieties. In addition, the possible subsequent molecular genetic analysis of the phytoextraction mutants may help to better understand mechanisms that govern metal accumulation in plants.

ACKNOWLEDGMENTS

The authors thank Guido Federer, Sara Bangerter and Cécile Bourigault for assistance with the screening of sunflower mutants in the field during four generations. We also thank Dr. André Gerth from Bioplanta for providing metal-contaminated soil for the greenhouse experiments. This work was supported by the Swiss Secretariat for Education and Research in the frame of the 5th European Framework Programme PHYTAC; EC Projects COST Actions 837 and 859; and the Swiss NSF.

BIBLIOGRAPHY

1. EEA Europe's Environment: The Thirds Assessment. Environmental Assessment Report No 10. Copenhagen, Denmark: European Environmental Agency (2003).
2. Chaney, R. Plant uptake of inorganic waste constituents. In: land treatment of hazardous wastes, p.50-76. (Parr, P., Marsh, P., Kla, J. Eds) Noyes Data, Park Ridge, NJ (1983).
3. Schwitzguébel, J.P. *et al.* Phytoremediation: European and American trends, success, obstacles and need. *J. Soils Sediments* **2**, 91-99 (2002).
4. Salt, D.E. *et al.* Phytoremediation. *Annu. Rev. Plant Phys.* **49**, 643-668 (1998).
5. Vassilev, A. *et al.* The use of plants for remediation of metal-contaminated soils. *The Scientific World Journal* (TSWJ) **4**, 9-34 (2004).
6. Robinson, B.H. *et al.* Phytoremediation: an assessment of biogeochemical and economic viability. *Plant And Soil* **249**, 117-125 (2003).
7. Herzig, R. *et al.* Evaluation of phytoremediation. p.161-190. In: phytac final report 2005: development of systems to improve phytoremediation of metal contaminated soils through improved phytoaccumulation, 249p. Quality of life and managing of living organisms (QIrt-2001-00429) (2005).
8. Reeves, R.D. *et al.* Metal-accumulating plants. In: phytoremediation of toxic metals – using plants to clean up the environment, p.193-229 (Raskin, I. And Ensley, B.D. Eds), John Wiley And Sons, New York (2000).
9. McGrath, S.P. *et al.* Field evaluation of Cd and Zn phytoextraction potential by the hyperaccumulators *Thlaspi Caerulescens* and *Arabidopsis Halleri*. *Environ. Pollut.* **141**, 115-125 (2006).
10. Madejón, P. *et al.* Trace element and nutrient accumulation in sunflower plants two years after the Aznalcóllar mine spill. *Sci. Total. Environ.* **307**, 239-257 (2003).
11. Nehnevajova, E. *et al.* Screening of sunflower cultivars for metal phytoextraction in a contaminated field prior to mutagenesis. *Int. J. Phytorem.* **7**(4), 337-349 (2005).
12. Finck, A. Fertilizer and fertilization, Verlag Chemie, Weinheim, West Germany, P.54 125 (1982).
13. Kashem, M.A., Singh, B.R. The effect of fertilizer additions on the solubility and plant-availability of Cd, Ni and Zn in soil. *Nutrient Cycling In Agroecosystems* **62**, 287-296 (2002).
14. Schwitzguébel, J.P. *et al.* Metal accumulation and metabolism in higher plants: potential for phytoremediation. In: Soil And Sediments Remediation, Mechanisms, Technologies and Applications, Chapter 15, p.289-307, (Lens, P., Grotenhuis, T., Malina, G., Tabak, H., Eds), IWA Publishing (2005).
15. Guadagnini, M. *et al.* *In vitro* züchtung, selektion und erprobung von metall-akkumulierenden tabakvarianten zur bodensanierung. *Terratech* **6**, 52-54 (1999).
16. Krämer, U. Phytoremediation: novel approaches to cleaning up polluted soils. *Curr. Opin. Biotechnol.* **16**, 133-141 (2005).
17. Nehnevajova, E. *et al.* *In vitro* breeding of *Brassica Juncea* L. To enhance metal accumulation and extraction properties. *Plant Cell Rep.* **26**, 429-437 (2007).
18. Maluszynski, M. *et al.* Application of *in vivo* and *in vitro* mutation techniques for crop improvement. *Euphytica* **85**, 303-315 (1995).
19. Maluszynski, M. *et al.* Induced mutations in rice breeding and germplasm enhancement. In: Proceedings of the 19th session of the International Rice Commission, p.194-204, Fao, Rome (1999).

20. Camargo, C.E.O. *et al.* Genetic diversity in wheat and breeding for tolerance to acid soils. p.321-323. In: *Induced Mutations And Molecular Techniques For Crop Improvement*, IAEA, Vienna (1995).
21. Nawrot, M. *et al.* Barley mutants with increased tolerance to aluminium toxicity. *Euphytica* **120**, 345-356 (2001).
22. Zhu, M.Y. *et al.* Mutation induced enhancement of Al tolerance in barley cell lines. *Plant Sci.* **164**, 17-23 (2003).
23. Delhaize, E. A metal-accumulator mutant of *Arabidopsis Thaliana*. *Plant Physiol.* **111**, 849-855 (1996).
24. Navarro, S. *et al.* Isolation of cadmium excluding mutants of *Arabidopsis thaliana* using a verticle mesh transfer system and ICP-MS. *J. Environ. Sci. Health* **34**, 1797-1813 (1999).
25. Nehnevajova, E. *et al.* Chemical Mutagenesis - a promising technique to increase metal concentration and extraction in sunflowers. *Int. J. Phytorem.* **9**, 149-165 (2007).
26. Osorio, J. *et al.* Mutant sunflowers with high concentration of saturated fatty acids in the oil. *Crop Sci.* **35**, 739-742 (1995).
27. Chandrappa, H.M. Mutageneiss in sunflower (*Helianthus Annuus* L.). Thesis Abstr. 8, 256-257. In: *Die Züchtung Der Sonnenblumen (Helianthus Annuus L.) Advanced In Plant Breeding 14, Supplements To Journal Of Plant Breeding* p.155, (Schuster, W.H., Ed.), Paul Parey Scientific Publisher, Berlin And Hamburg (1982).
28. Kübler, I. Veränderungen verschiedener inhaltsstoffe in einzelnen sonnenblumenfrüchten nach mutagener behandlung in M₂ und M₃. *Fette-Seifen-Anstrichmittel* **2**, 62-70 (1984).
29. Nehnevajova, E. *et al.* Stability of enhanced yield and metal uptake by sunflower mutants for improved phytoremediation, *Int. J. Phytorem.*, Submitted (2008).
30. Madejón, P. *et al.* Trace element and nutrient accumulation in sunflower plants two years after the Aznacóllar mine spill. *Sci. Total. Environ.* **307**, 239-257 (2003).

Anjitha - A New Okra Variety through Induced Mutation in Interspecific Hybrids of *Abelmoschus* Spp.

P Manju* & R Gopimony†

Abstract

Studies on interspecific hybrids of okra between *A. esculentus* (cultivated type) and *A. manihot* (wild type) revealed that no useful recombinants were obtained from the conventional breeding programme because of the strong linkage between yellow vein mosaic (YVM) resistance genes and the wild character of *A. manihot*. This study was aimed at breaking this undesirable linkage through gamma irradiation (100, 200, 300 and 400 Gray) of F_1 seeds obtained by interspecific hybridization between *A. esculentus* var. Kiran and *A. manihot* and further evaluating and selecting high yielding YVM resistant types from the generations segregating until F_6M_6 . The mutagenic effectiveness and efficiency increased with increasing doses of Gamma-rays. In the segregating generations, the irradiated treatments were late flowering and had more leaves, flowers and fruits per plant. Average fruit weight was maximum in 200Gy, while fruit yield was maximum in 400Gy due to larger number of fruits. A few high yielding disease-resistant plants resembling the cultivated plants were obtained in 300Gy which suggested that 300Gy could be the ideal irradiation dose in okra. Superior genotypes selected from F_6M_6 generation based on yield and YVM resistance were advanced to CYTs and farm trials. Cultivar AE18 outyielded the others and was released as “Anjitha” during 2006, for cultivation in the Thiruvananthapuram District of Kerala. Anjitha is a high yielding variety having the fruit characters and quality of the cultivated parent *A. esculentus* var. Kiran combined with the YVM-resistant character of the wild parent *A. manihot*.

Introduction

Okra or bhindi (*A. esculentus* (L.) Moench) is an important annual vegetable crop grown throughout India for its tender green fruits. Due to its high adaptability, it can be cultivated under a wide range of environmental conditions. However, the susceptibility of most okra cultivars to yellow vein mosaic (YVM) disease is a major problem limiting the growth and yield of the crop considerably, with yield losses ranging from 50 to 90% depending on the stage of crop growth at which infection occurs [1]. In India, YVM disease was first reported [2]. The virus, neither sap nor seed transmissible, is readily transmitted by grafting and also through whitefly (*Bemisia tabaci* Gen.) [3]. *A. manihot*, the semi-wild species is resistant to the YVM virus [4], while the cultivated species *A. esculentus* is usually susceptible. Therefore, *A. manihot* could be used as suitable donor of resistance to improve susceptible adapted varieties, but interspecific hybridization between *Abelmoschus esculentus* and *A. manihot* did not yield useful recombinants due to a strong linkage between disease resistance and the semi-wild characters of *A. manihot* in the F_2 generation [5]. Variability can be induced by subjecting hybrid seeds of okra to mutation and compared to the F_2 , the proportion of recombinants was higher in the F_2M_2 population indicating the break-

age of such undesirable linkage through irradiation [6]. This study was undertaken with a view of breaking the undesirable linkage through gamma irradiation of F_1 seeds obtained by interspecific hybridization between *A. esculentus* var. Kiran and *A. manihot*, so that useful recombinants with YVM disease resistance, high fruit yield and quality could be obtained.

Materials and Methods

The study was carried out in the Department of Plant Breeding and Genetics, College of Agriculture, Vellayani wherein the parents, Kiran, a high-yielding locally adapted *A. esculentus* cultivar (P_1), and *A. manihot*, a YVM disease resistant semi-wild species (P_2), were crossed, and the F_1 hybrid seeds were irradiated using Gamma-rays at four doses viz. 100, 200, 300, 400Gy along with a control. F_1M_1 , F_2M_2 up to F_6M_6 generations were studied and evaluated. Compact Family Block Design was adopted for F_2M_2 and F_3M_3 generations using seven treatments, five replications and 10 progeny rows of 10 plants each per treatment, while Randomised Block Design was adopted for the remaining experiments. Since most progenies from F_6M_6 had become stable, 13 progenies were selected and selfed and were subjected to three Comparative Yield Trials (CYT). The superior cultures from the CYTs were subjected to Farm Trials along with the standard variety Kiran and a local check variety of the farmer. The crops were raised under insecticide free condition and susceptible check Kilichundan was grown as border plants for all the experiments. Incidence of YVM disease was scored based on the rating scale [7].

Results and Discussion

F_1M_1 generation

Studies on F_1M_1 generation revealed that seed germination, survival of plants and plant height decreased with increased dose of Gamma-rays while pollen fertility increased in the irradiated hybrids. The undesirable changes resulting from chromosomal aberrations and toxicity are manifested as M_1 damage such as lethality, injury, sterility, and these are measured as reduction in germination, survival, plant growth and fertility, and increase in frequency of chromosomal aberrations and chlorophyll deficient chimeras. There was a progressive reduction in the mean values for percentage germination and survival in both laboratory and field conditions, and germination percentage was found to decrease with increase in level of irradiation. Such a decrease in germination at higher doses of Gamma-rays was also reported in brinjal [8]. The treated hybrids showed delayed germination compared to the control (Table 1). Similar results were reported in sorghum [9]. This may be due to the influence of mutagen on plant growth regulators which caused a delay in the initiation of germination. The reduction in the survival of plants is an index of post-germination mortality as a result of cytological and physiological disturbances due to radiation effect. The observations on internodal length, number of branches and plant height showed that the rate of growth was reduced by the mutagen. This reduction could be due to auxin destruction, and it may also be attributed to the influence of ionizing radiation leading to the genic loss due to chromosomal

Department of Plant Breeding and Genetics, Kerala Agricultural University, College of Agriculture, Vellayani, Thiruvananthapuram, Kerala, India

† Present address: “Anjali”, Gowreesapattom, Thiruvananthapuram, Kerala, India (Retd. Professor and Head of Plant Breeding and Genetics, College of Agriculture, Vellayani, Thiruvananthapuram)

* Corresponding author. E-mail: manju_ptn@yahoo.co.in

aberrations [10]. The irradiated hybrids showed an increased root to shoot ratio compared to the control. A progressive decrease in pollen sterility was observed with increase in radiation dose, that might be the result of normal chromosome pairing which was dependent on dose of gamma radiation and indicates the possibility of obtaining high fertile segregants in the succeeding generations of the irradiated population. The mutagenic effectiveness was found to increase with increase in dose of Gamma-rays. Mutagenic efficiency estimated on the basis of lethality and injury increased with increase in dose of Gamma-rays while on the basis of sterility, 300Gy treatment showed the highest efficiency. Number of fruits per plant increased with increase in dose of Gamma-rays while weight of fruits per plant was more in the irradiated treatments compared to both the parents. Fruit length decreased while girth increased in the irradiated treatments compared to the cultivated parent. YVM incidence was low in the irradiated treatments, similar to the semi-wild parent.

F₂M₂ and F₃M₃ generations

In the F₂M₂ and F₃M₃ generations, the irradiated treatments were found to be late-flowering compared to the un-irradiated treatment and the cultivated parent. Irradiation was found to increase the number of leaves per plant, flowers per plant, fruits per plant, pollen sterility and plant height and decrease in YVM disease incidence compared to the cultivated parent (Table 2). A preponderance of low yielding YVM resistant plants similar to the donor parents among the F₂ and F₃M₂ populations was observed, indicating the presence of a strong genetic mechanism preventing free recombination [6]. Gamma radiation created considerable genetic variability in interspecific *A. esculentus* x *A. manihot* F₁ hybrids and they observed that higher doses (above 250Gy) should be used to create wider variability in the interspecific hybrids and also reported

that, compared to F₂, the proportion of recombinants was higher in the F₂M₂ population indicating the breakage of undesirable linkages through irradiation [11]. However, a few high-yielding YVM disease-resistant plants resembling the cultivated parent were observed in 300Gy in the present study. The fruit yield per plant was more in irradiated treatments due to the larger number of fruits. The same trend noticed in the F₁M₁ generation was observed in F₂M₂ and F₃M₃ generations with respect to fruit characters and yield.

F₄M₄, F₅M₅ and F₆M₆ generations

In the F₄M₄, F₅M₅ and F₆M₆ generations, out of the 50 families studied, nine recorded less number of days to 50% flowering than the cultivated parent. In F₄M₄, occurrence of segregants with higher mean values for number of flowers and fruits per plant than both the parental means was noticed. Average fruit weight exhibited a reduction in mean value, whereas fruit yield per plant increased as a result of increase in number of fruits per plant. This is in conformity with the findings that irradiation induced delayed flowering and produced increased number of flowers, fruits and weight of fruits per plant and YVM resistant plants in irradiated treatments [12]. Duration of the plants were longer than the cultivated parent while plant height of the progenies exceeded both the parents. Incidence of YVM was lower in the F₄M₄, F₅M₅ and F₆M₆ generations compared to the cultivated parent. By F₅M₅ generation, number of fruits per plant, yield of fruits per plant, length and girth of fruit increased in all the families compared to both the parents indicating good response to selection in the previous generation. The crude fiber content of the fruits was maximum in the wild parent. All the F₅M₅ and F₆M₆ families had fruits with crude fiber content equal to or less than than the cultivated parent. Only a narrow range of variability was noticed for crude fiber content of fruits by [13]. The majority of the

Table 1. Effect of Gamma-rays on different characters in F₁M₁.

Hybrid/parent	Gamma-rays (GY)	Germination%	Survival%	Internode length (cm)	Branches/plant	Plant ht (cm)	Root/shoot ratio	Pollen fertility	No. of fruits/plant	Wt. of fruits / plant (g)	Fruit length (cm)	Fruit Girth (cm)	YVM incidence
P1xP2	0	74.2(59.4)	100	10.8	25.5	155.8	0.78	15.2(22.9)	15.0	265.2	11.9	8.1	1.0 (1.0)
P1xP2	100	70.4(57.0)	95.4	10.0	27.5	141.9	1.08	18.2(25.2)	15.6	306.4	10.4	7.4	1.0 (1.0)
P1xP2	200	69.1(55.6)	90.8	10.3	24.9	135.9	1.11	22.0(27.9)	15.9	289.6	10.2	7.6	1.0 (1.0)
P1xP2	300	63.4(52.7)	89.7	9.4	21.9	127.1	1.18	24.7(29.8)	16.0	270.8	9.3	7.7	1.0 (1.0)
P1xP2	400	54.6(47.6)	84.0	8.7	29.7	120.7	1.27	29.0(32.5)	16.4	287.0	11.3	6.8	1.0 (1.0)
P1	0	79.1(62.8)	100	7.9	11.8	96.1	0.81	90.5(72.0)	10.4	202.2	14.8	6.0	3.3 (1.8)
P2	0	82.2(65.0)	100	6.8	18.1	108.0	0.83	94.0(75.8)	6.6	153.7	11.1	8.2	1.0 (1.0)
CD (0.05)		7.07	1.43	1.02	7.87	14.7	0.12	1.23	3.8	71.38	1.00	0.44	0.03

Transformed values are given in parentheses

Table 2. Effect of Gamma-rays on different characters in F₂M₂ and F₃M₃ generations (mean of 2 generations).

Treatment	N°. of leaves	N°. of flowers	Pollen sterility%	N°. of fruits	Wt. of fruits / plant(g)	Fruit length (cm)	Fruit girth (cm)	Plant height (cm)	Plant duration (days)	YVM incidence
0Gy	18.2	12.0	27.8	10.5	130.2	10.7	5.7	145.0	136.2	1.2 (1.1)
100GY	49.1	39.6	37.9	33.7	264.1	8.6	5.1	148.5	142.8	1.5 (1.2)
200Gy	50.4	40.6	31.2	35.1	313.4	9.4	5.3	152.3	154.5	1.6 (1.3)
300Gy	30.5	22.9	29.0	19.8	236.5	11.6	5.5	139.8	141.5	2.0 (1.4)
400Gy	45.8	22.5	30.5	32.1	314.6	12.0	6.1	134.4	154.4	2.3 (1.5)
P1	19.1	14.0	3.8	13.2	185.9	14.6	5.4	112.6	126.0	2.4 (1.6)
P2	22.0	15.1	26.4	14.1	248.0	14.5	8.3	121.5	163.0	1.2 (1.1)
SE	1.39	1.35	0.93	1.32	15.93	0.27	0.12	3.30	1.01	0.03

families exhibited increases in the mean values for the economically important characters and combined high yield with resistance to YVM disease. The best lines of the families in F_6M_6 generation were selected and advanced to Comparative Yield Trials.

Comparative Yield Trials

Comparative Yield Trials were conducted using 13 promising genotypes selected from the F_6M_6 generation for three seasons to get consecutive results. The pooled mean data with regard to yield and yield attributes and incidence of YVM disease incidence (Table 3) showed that culture AE 18 had the maximum number of fruits and highest yield, followed by AE 25 and AE 17. AE 18 had long fruits, the longest being for AE 8. Culture AE 18 had shorter duration compared to the check variety Kiran and the three cultures AE 18, 25 and 17 had no YVM disease incidence, while variety Kiran had a very high incidence of the disease (89.8%). Considering the superiority of AE18 in terms of yield, duration and YVM disease resistance, it was recommended for farm trials in Thiruvananthapuram district.

Table 3. Pooled mean data of three Comparative Yield Trials.

Cul.No	Fruits / plant	Length of fruit (cm)	Yield tons/ha	Duration(days)	Incidence of YVM (%)
AE 1	11.8	15.9	10.4	95.0	1.2
AE 4	13.1	19.2	10.6	95.1	0.0
AE 7	13.5	16.0	10.8	94.4	0.0
AE 8	11.5	22.8	9.0	95.8	0.9
AE 11	13.1	15.8	10.4	94.4	0.0
AE 12	13.3	18.9	10.7	93.8	0.0
AE 16	13.8	19.1	11.8	94.3	3.6
AE 17	14.9	18.8	13.5	96.0	0.0
AE 18	16.6	19.3	14.6	94.3	0.0
AE 19	12.9	17.7	11.0	93.8	0.0
AE 20	13.7	14.9	11.3	95.7	0.0
AE 24	13.5	17.3	11.1	94.8	0.0
AE 25	15.6	18.1	14.3	95.1	0.0
Kiran	9.6	14.7	6.6	97.3	89.8
CD (0.05)	2.84	2.73	2.80	2.10	7.18

Table 4. Farm trial with okra culture AE 18.

Sl No	Locations	Fruit yield tons / ha		YVM Incidence (%)		Length of fruit (cm)	
		AE 18	Kiran (std check)	AE 18	Kiran (std check)	AE 18	Kiran (std check)
1.	Nedumangad	14.9	8.1	2.5	40	15.0	13.0
2.	Pothencode	13.1	5.9	1.0	100	16.0	14.5
3.	Kariyavattam	11.7	9.6	0	78.0	18.5	13.5
4.	Anad	13.7	8.5	1.0	33.0	16.0	13.0
5.	Neyyattinkara	11.3	5.3	0	40.0	16.5	11.0
6.	Kattaikonam	13.3	8.9	0	30.0	17.0	11.0
7.	Kazhakuttam	10.0	3.4	0	90.0	16.0	14.0
8.	Kalliyoor	19.1	7.2	0	95.0	18.5	10.5
9.	Thannimoodu	14.7	5.8	0	75.0	16.0	13.5
10.	Karakulam	17.5	8.3	0	100	16.0	15.3
11.	Venganoor	8.8	3.2	1.7	95.0	18.0	11.0
12.	COA Vellayani	17.3	4.1	0	98.0	19.5	14.0
	Mean	13.78	6.52	0.51	72.83	16.9	14.0
	CD (0.05)	2.099		16.415		1.05	

Farm Trials

Farm trials were conducted with culture AE 18 and the standard check variety Kiran in farmer fields in 12 locations in Thiruvananthapuram district during the summer of 2004. Culture AE 18 was found to be significantly superior to the check variety Kiran with regard to mean fruit yield, fruit length and YVM disease incidence (Table 4). Hence it was released as a new variety 'Anjitha' for cultivation in the Thiruvananthapuram district of Kerala by the XXIII State Seed Sub Committee during 2006.

Table 5. Description of the variety Anjitha and the parents P_1 and P_2 .

Sl.No.	Character	<i>A.esculentus</i> var Kiran (P_1)	<i>A.manihot</i> (male parent) (P_2)	Anjitha
		Cultivated variety	Wild species	New variety
1.	Days to first flowering	42	55	39
2.	No. of fruits per plant	9.6	11.5	16.6
3.	Length of fruit (cm)	14.7	8.5	19.3
4.	Girth of fruit (cm)	5.3	8.1	6.0
5.	No. of ridges per fruit	5.0	7.6	5.0
6.	Fruit yield tons /ha	8.9	9.6	14.6
7.	Height of the plant (cm)	103	80.2	135
8.	Duration	97.3	159	94.3
9.	YVM incidence	susceptible	resistant	resistant
10.	Shoot & fruit borer incidence (%)	22.5	3.0	4.0
11.	Crude Fiber (g/100g)	1.7	2.6	1.5

Summary

Anjitha (AE18) is an early flowering type with a larger number of long fruits having five ridges per fruit developed through induced mutation (300Gy dose) in interspecific hybrids of *Abelmoschus* spp (Table 5). The plant has high fruit yield and good fruit quality with less fiber content. It is resistant to YVM disease and tolerant to fruit and shoot borer attack. Anjitha has the fruit characters and quality of the cultivated parent *A.esculentus* var. Kiran combined with the YVM-resistant character of the wild parent *A.manihot*.

ACKNOWLEDGEMENTS

The authors are thankful to the Kerala Agricultural University, Thrissur for providing the funds for conducting the studies on 'Development of High-yielding Varieties of Okra Resistant to Yellow Vein Mosaic Disease From Among the Segregating Generations of Induced Recombination' based on which the new variety Anjitha was developed. They are also thankful to the Associate Director, NARP(SR), Vellayani, Thiruvananthapuram for providing the facilities for conducting the experiments and for making available the funds in time from the University for the above project.

BIBLIOGRAPHY

- Sastry, K.S.M., Singh, S.J. Effect of YVM virus infection on growth and yield of okra crop, *Indian Phytopath* **27**, 294-297 (1974).
- Kulkarni, G.S. Mosaic and other diseases of crops in the Bombay Presidency, *Proc. 11th Sci. Cong.* **42**, 3 (1924).
- Verma, P.M. Studies on the relationship of bhindi YVM and its vector, the white fly (*Bemisia tabaci*). *Indian J. Agric. Sci.* **25**, 75-91 (1952).
- Celliah, S., Sreenivasan, K. Resistance in bhindi, brinjal and tomato to major insects and mite pests. In: national seminar on breeding crop plants for resistance to pests and diseases, Coimbatore, India, 35-40 (1983).

5. Mathews, H. Evaluation of the F_2 generation of interspecific hybrids of *Abelmoschus* with reference to yellow vein mosaic resistance and yield. M.Sc (Ag) Thesis, Kerala Agric. Univ., Thrissur (1986).
6. Sheela, M.N. Induction of genetic recombination in interspecific crosses of *Abelmoschus*, Ph.D Thesis, Kerala Agric. Univ., Thrissur, (1994).
7. Arumugam *et al.* *Abelmoschus Manihot* : a source of resistance of bhindi yellow vein mosaic. *Madras Agric. J.* **62**, 310-312 (1975).
8. Gopimony, R. Genetic studies in brinjal with relation to bacterial wilt resistance, Ph.D Thesis, Kerala Agric. Univ., Thrissur, (1983).
9. Sree Ramulu, K. Mutagenic sensitivity of different genotypes of sorghum in treatments with radiation, chemical mutagens and combination treatments. *Madras Agric. J.* **57**(5), 279-288 (1980).
10. Evans, H.J., Sparrow, A.H. Nuclear factor affecting radiosensitivity. II. Dependence of nuclear and chromosome structures and organization. *Brookhaven Symposia In Biology* **14**, 101-127 (1961).
11. Cheriyan, D. Radiation induced variability in interspecific hybrids involving *A.Esculentus* and *A.Manihot*. M.Sc (Hort.) Thesis, Kerala Agric. Univ., Thrissur (1984).
12. Animon, G. Induced mutation in interspecific hybrids of *Abelmoschus* spp. M.Sc (Ag) Thesis, Kerala Agric. Univ., Thrissur (1996).
13. Elangovan *et al.* Evaluation of bhindi hybrids and their parents for crude fiber content. *South Indian Hort.* **31**, 241-243 (1983).

Genetic Improvement of Chickpea (*Cicer arietinum* L.) Using Induced Mutations

J D Barshile^{1*} & B J Apparao²

Abstract

The main target of chickpea breeding programmes has been to develop high yielding cultivars. In an attempt to induce genetic variability for improvement of locally popular chickpea cultivar Vijay (Phule G-81-1-1), we employed three well known mutagens, sodium azide (SA), ethyl methane sulphonate (EMS) and gamma radiation (GR). The objective was to provide genetic variability in the yield contributing traits that can be exploited for a genetic improvement of chickpea. Seeds of Chickpea cultivar Vijay were treated with three different concentrations / doses of SA (2, 3 and 4 mM), EMS (8, 12 and 16 mM) and gamma radiations (400, 500 and 600 Gy). In M_1 generation no dominant mutations were observed, many different mutants were screened and isolated in M_2 generation such as chlorophyll mutations (alnina, chlorina and xantha); leaf mutations (gigas, compact and curly); pod mutations (small, roundish, gigas and narrow elongated); seed mutations (green, dark brown, rough seed coat); flower mutations (white flower and open); morphological mutations (early, sterile, tall and gigas). True breeding mutant lines in M_3 generation differed considerably in their quantitative traits from the parent cultivar. The early mutant lines matured 10 days earlier than the parent variety. The range in plant height was expanded from 0.02 to 14.91cm. Gigas mutant lines obtained after 400 Gy gamma irradiation were the tallest (44.44cm), with a 2-3 fold increase in pod and seed size over the control. Mutagenic treatments also caused changes in seed size and seed coat. Considerable genotypic variation was observed with regards to the number of seeds and pods per plant. Small leaf mutants showed double the number of seeds and pods per plant. As a result of mutagenic treatments, genetic variation was induced in mutants with respect to different quantitative characters. Induced mutant lines showed both positive and negative increase in the quantitative traits. Variation was also observed for crude protein, globulin and albumin content of mutants.

Introduction

Chickpea (*Cicer arietinum* L.) is a widely cultivated and important food grain legume in the Indian sub-continent. It is a major source of protein for both humans and livestock. In spite of its high economic importance, its yield did not witness much appreciation during the past decade [1]. It has been argued that one of the reasons for failure to achieve a breakthrough in productivity in chickpea is the lack of genetic variability [2]. The improvement of chickpea using conventional breeding approaches has been hampered due to lack of sufficient genetic variability. Therefore, there is an urgent need to develop new plant types for different situations. A common and efficient tool to create new desirable genetic variability in chickpea is mutagenesis [3]. Although studies on induced mutations have been undertaken in the past in some legumes, limited

reports are available on chickpea [4]. In the present investigation, an attempt has been made for genetic improvement of the locally adapted cultivar of chickpea, Vijay, through induction of mutations employing potent mutagens like gamma radiation, sodium azide and ethyl methane sulphonate.

Materials and Methods

Seeds of Chickpea (*Cicer arietinum* L.) cultivar Vijay (Phule G-81-1-1), were obtained from the Mahatma Phule Agriculture University, Rahuri, India. Healthy seeds containing 10-12% water were treated separately with chemical (SA and EMS) and physical (gamma radiation) mutagens. For chemical mutagen treatments, seeds were presoaked in distilled water for 6 hours and then subjected to 2, 3 and 4 mM SA and 8, 12 and 16 mM EMS, for 12 hours at $25\pm 2^\circ\text{C}$. The treated seeds were thoroughly washed under running tap water for an hour to terminate the reaction of the chemical. For physical mutagen treatment, dry seeds were irradiated with 400, 500 and 600 Gy from a ^{60}Co source available in the Department of Biophysics, Government Institute of Science, Aurangabad (M.S., India). Each treatment was carried out for 250 seeds.

All treated seeds along with control were sown in the field at a spacing of 15cm within rows and 45cm between rows to raise the M_1 generation during the 2002 growing season. All M_1 plants were harvested separately to raise M_2 generation. Screening and evaluation of M_2 generation was performed during the 2003 growing season, using a randomized block design (RBD) with 3 replicates at experiment field of Shri Anand College, Pathardi. In M_3 generation, mutant seeds were planted in RBD, with 3 replications. Data were collected for 6 agronomic traits (plant height, plant spread, number of pods per plant, number of seeds per plant, yield per plant and 100 seed weight). Total protein, globulin and albumin were estimated following the method of Lowry, *et al.* [5]. The nitrate reductase activity from leaf samples of chickpea at flowering stage was performed as described earlier by Sawhney, *et al.* [6]. The analysis and comparison of proteins were carried out by the SDS-PAGE following the method of Laemmli [7]. Data was analyzed using Dry software programme. The genotypic and phenotypic coefficients of variation were estimated following the method of Burton and De Vane [8]. The heritability and genetic advance were calculated following the methods suggested by Hanson, *et al.* [9] and Johnson, *et al.* [10], respectively.

Results and Discussion

Spectrum and frequency of mutations

M_2 generation was comprised of 189 families with a total plant population of 4898 surviving plants at harvest. The morphological mutants isolated mainly showed an altered leaf structure, plant shape, seed size, seed colour, seed structure and days of the maturity (**Plate 1**). A high frequency and spectrum of viable mutations was observed in the M_2 generation of chickpea cultivar Vijay with all three mutagens, which were completely absent in the control, and increased in a concentration/dose dependent manner of the mutagen employed (**Table 1**).

A high frequency of viable mutations was observed with gamma

¹ Shri Anand College of Science, Pathardi, District Ahmednagar, Maharashtra State, India, PIN 414 102.

² Padmashri Vikhe Patil College of Arts, Science and Commerce, Pravaranagar, At/Po. Loni (Kd), Taluka Rahata, District Ahmednagar, Maharashtra state, India, PIN 413 713.

* Corresponding author. E-mail: jagannath_barshile@rediffmail.com

Table 1. Spectrum and frequency of induced mutations in M₂ progeny of chickpea cultivar Vijay

Treatment Conc./Dose	M ₂ population	M ₁ families	Spectrum of mutations				Total frequency of mutations
			Leaf mutants	Plant type mutants	Pod/ seed mutants	Sterile mutants	
2 mM SA	431	21	00	0.92	0.23	00	1.16
3 mM SA	582	21	00	1.03	0.51	00	1.54
4 mM SA	615	21	0.16	1.47	0.65	00	2.28
Mean			0.05	1.14	0.46	00	1.66
8 mM EMS	525	21	1.33	1.71	0.57	00	3.62
12 mM EMS	541	21	1.08	1.80	0.73	0.36	3.97
16 mM EMS	550	21	2.40	1.66	1.10	0.18	5.34
Mean			1.60	1.72	0.80	0.18	4.31
400 Gy GR	596	21	0.17	1.51	0.67	00	2.34
500 Gy GR	539	21	0.74	4.82	0.37	0.18	6.12
600 Gy GR	519	21	0.38	4.62	1.54	0.38	6.93
Mean			0.43	3.65	0.86	0.19	5.13
Total	4898	189					

Table 2. Mean performance for quantitative traits among selected M₃ mutant lines of chickpea

Mutant/ control	Mutagen and dose	Plant height (cm)	Plant Spread (cm)	Number of Pods plant-1	Number of seeds plant-1	Seed yield plant-1 (g)	100 seed weight (g)
Control	-	29.53	25.00	36.33	37.00	8.23	22.99
Small leaf	12 mM EMS	32.74	30.94	72.00	76.33	11.54	15.13
White flower	8 mM EMS	32.40	28.77	26.33	27.33	5.31	19.47
Narrow leaf	400 Gy GR	33.77	22.31	45.33	47.66	7.02	14.87
Rough seed	3 mM SA	37.50	22.66	39.66	45.33	9.33	19.64
Early	500 Gy GR	29.55	20.44	42.33	48.33	9.46	19.58
Gigas	400 Gy GR	44.44	24.66	15.33	15.33	5.77	37.78
Compact	4 mM SA	31.41	27.66	35.66	37.01	6.06	16.46
Green seed	500 Gy GR	34.08	30.55	24.00	25.33	4.68	18.65
Bold seeded	500 Gy GR	32.63	26.11	29.66	31.33	6.75	31.79
C V		6.423	8.333	24.48	23.81	20.12	10.17
SE +		1.236	1.240	5.12	5.31	0.844	1.19
CD(p=0.05)		3.671	3.684	15.22	15.78	2.507	3.556
CD(p=0.01)		5.035	5.053	20.88	21.65	3.438	4.876

radiation followed by EMS and SA treatments. The frequency of viable mutations ranged from 1.16 to 6.93. Gamma radiation induced a wider spectrum of viable mutations. At 500 Gy of gamma radiation, mutation frequency was highest as seen in the mutagenized population for plant type, 16 mM EMS treatment induced a high frequency of leaf morphological mutations (2.40). On the other hand, SA treatments showed the least spectrum and lowest frequency of viable mutations. Kharkwal [11] attributed the differences in frequency and spectrum of viable mutations induced by various mutagens to genetic differences in the cultivars, while Konzak, *et al.*, [12] have reported that even as small as a single gene difference could bring about significant changes not only in the spectrum but also the frequency of recoverable mutations.

In this research with Vijay chickpea, we observed that the spectrum and frequency of induced viable mutations increased with increasing concentrations/doses of SA, EMS and gamma radiation. This could be due to a differential mode of action of the mutagens on different base sequences in various genes.

Quantitative traits

Nine mutants were compared for mean values of quantitative traits with parental cultivar Vijay in the M₃ generation. Both positive and negative

mutation occurred as compared to the parental cultivar. The plant height ranged from 29.55 to 44.44cm in M₃ generation as compared to 29.53cm in the parent. Overall, mean height increase ranged from 33.56% in Gigas mutant to 21.26% in round seed mutant as compared to the control.

Most mutants showed both a positive and a negative plant spread. A significant reduction in plant spread was observed in the early mutant. Conversely, small leaf and green seed mutants showed a significant increase in plant spread over the control. The maximum number of pods per plant compared to the control was observed for the small leaf mutant followed by the narrow leaf mutant. Among all mutant lines, the highest number of seed per plant was observed in small leaf mutant (76.33) compared to control (37). The small leaf mutant showed a significantly higher yield per plant (11.54 gm) over the parental cultivar (8.23 gm), whereas it was reduced in the white flower mutant and gigas mutant in M₃ generation. Narrow leaf, small leaf and compact mutants had lower 100 seed weight. Gigas and bold seeded mutants showed significantly higher 100 seed weight, which was attributed to the increased cotyledonary cell volume whilst retaining a similar cell number per unit area [13].

In all the mutants, days to maturity ranged from 89.66 to 110 days. The early maturing mutant was significantly earlier (at least 10 days) in flowering and maturity compared to the parental cultivar (Table 3). Rough

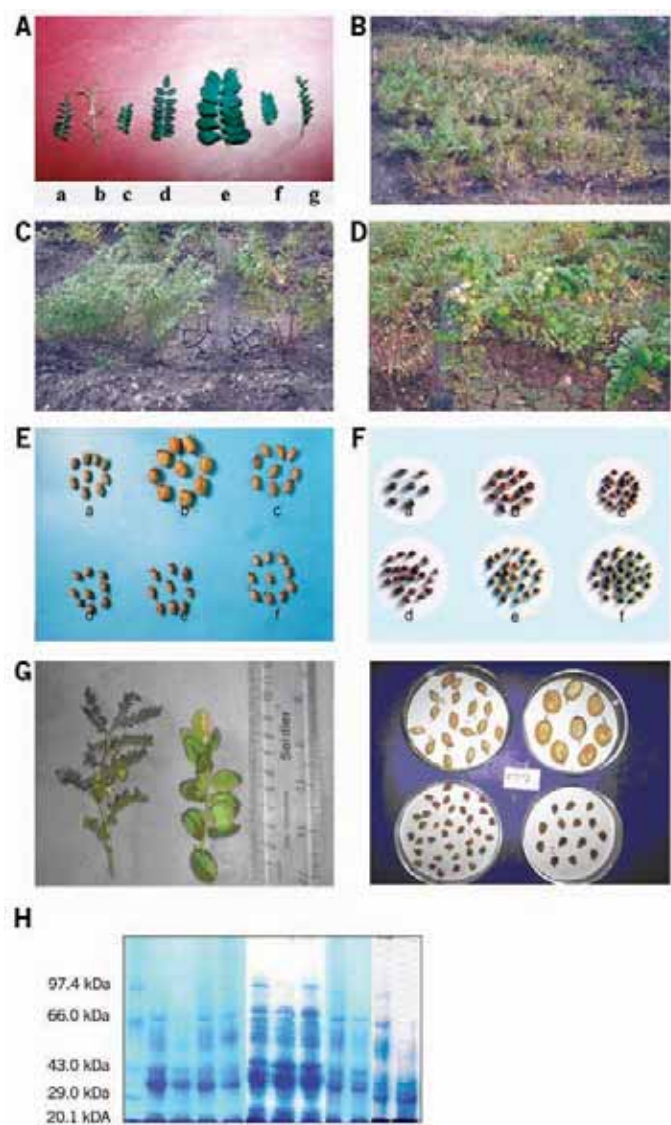

Figure 1 (A) Leaf mutation-a. narrow, b. tiny, c. small, d. parent (control), e. gigas, f. compact and g. curly leaf, (B) Early mutant and parent, (C) Parent (right) and compact mutant (left), (D) Parent (left) and gigas mutant (right), (E) Pod- a. parent, b. gigas, c. long, d. small roundish, e. narrow elongated and f. small, (F) Seed- a. parent, b. bold, c. blacked spotted, d. green, e. rough seed coat and f. brown, (G) Parent (left) leaves, pods, seeds and gigas mutant (right) leaf, pods and seeds, (H) SDS-PAGE protein profile of chickpea in induced mutants of Vijay in M_3 generation.

seed and bold seeded mutants showed similar maturity as the parent. Early mutant matured earlier than the parent and thus will cope better with the late season and moisture stress that is usually encountered in the chickpea growing areas in the state of Maharashtra. Early maturing mutants can be of great importance in the areas with short rainfall also. Early mutants have been reported earlier in chickpea [14] and pigeonpea [15]. These findings showed that the mutations induced have generated a variability for quantitative traits that offers a wide scope for genetic improvement of chickpea in forthcoming breeding programmes.

Estimation of protein content and nitrate reductase activity
Seed protein content in the parent cultivar was 256.66 mg g^{-1} while it ranged between 228.73 to 284.2 mg g^{-1} in mutants (Table 3). Bold seeded, compact and gigas mutants showed a significantly higher protein content. The bold seeded, compact and small leaf mutants showed significantly higher globulin and albumin contents among mutants in

the M_3 generation. The highest nitrate reductase activity was observed in gigas mutant followed by compact mutant. The lowest value was observed in green seed mutant in the leaves examined. Nitrate reductase activity showed a positive correlation with protein content. Therefore, the results indicate that nitrate reductase could be used as a tool to correlate with protein content and overall productivity of mutants in early stage. Our result for nitrate reductase activity is in agreement with those obtained by Aparna, *et al.* [16].

Table 3. Mean performance of selected M_3 mutant lines for maturity, protein, globulin, albumin and nitrate reductase activity of chickpea

Mutant/ control	Days to maturity	Protein (mg g^{-1})	Globulin (mg g^{-1})	Albumin (mg g^{-1})	N R ($\mu \text{ moles / g.fr.wt.}$)
Control	99.66	256.66	163.30	55.1	2.06
Small leaf	106.33	261.06	181.33	60.16	2.16
White flower	98.66	257.56	170.76	56.36	2.10
Narrow leaf	99.33	235.86	130.6	56.43	1.76
Rough seed	99.66	265.43	171.5	77.23	2.27
Early	89.66	261.73	175.63	79.03	2.16
Gigas	110.00	274.50	171.66	61.96	2.64
Compact	102.66	274.76	176.76	82.33	2.72
Green seed	106.66	228.73	151.63	74.33	1.62
Bold seeded	99.66	284.20	187.81	73.21	3.10
C V	1.638	1.41	1.082	1.60	0.19
SE +	0.960	2.08	1.099	0.70	0.08
CD(p=0.05)	2.853	6.18	3.265	2.078	0.25
CD(p=0.01)	3.913	8.48	4.479	2.851	0.34

Heritability and variability components for quantitative traits among the mutants

Data in Table 4 indicates that a consistently greater PVC was observed than the GCV in different quantitative traits among the induced mutants. Comparison among traits indicated that the number of seeds per plant recorded the greatest PCV (43.36%) followed by number of pods per plant and 100 seed weight. Plant height and plant spread had the lowest PCV among the mutants. Because of the enhanced reproductive growth in terms of the number of seeds per plant, diversion of the photosynthates towards vegetative growth probably was minimized resulting in the lowest PCV and GCV for plant height. High PCV and GCV values for number of pods per plant and number of seeds per plant indicated further scope of yield improvement through selection of the donor for breeding in chickpea.

Table 4. Heritability and variability for quantitative traits among the mutants in M_3 generation

Quantitative traits	PCV (%)	GCV (%)	H_2 (%)	GA
Plant height (cm)	13.62	12.80	88.32	8.34
Plant spread (cm)	16.77	13.87	73.66	6.43
Number of Pods (plant-1)	42.94	41.84	94.94	30.79
Number of seeds (plant-1)	43.36	42.72	97.07	33.85
Seed yield (plant-1g)	30.97	28.34	87.71	9.97
100 seed weight (g)	34.92	34.20	95.74	14.87

High heritability coupled with high genetic advance was observed for quantitative traits like number of seeds per plant and number of pods

per plant (Table 4), may be due to additive genes. On the contrary, both heritability and genetic advance were less for plant spread. Badigannavar and Murty [17] reported a high heritability associated with a high genetic advance for plant height, pod yield and seed yield in gamma rays induced mutants of M_8 generation. We are of the opinion that selection based on heritability and genetic advance for number of seeds per plant and number of pods per plant may be effective induced mutations for improvement of chickpea.

ACKNOWLEDGEMENTS

We are thankful to Mahatma Phule Krishi Vidyapeeth, Rahuri, India for providing the seeds and Dr. S.B. Pawar, Principal, Shri Anand college of Science, Pathardi for providing laboratory facilities. The first author is thankful to UGC, New Delhi, India, for the financial assistance.

BIBLIOGRAPHY

- Barshile, J.D., Auti, S.G., Dalve, S.C., Apparao, B.J. Mutagenic sensitivity studies in chickpea employing SA, EMS and Gamma rays. *Indian J. Pulses Res.* **19**, 43-46 (2006).
- Wani, A.A., Anis, M. Gamma rays induced bold seeded high yielding mutant in chickpea. *ICPN* **45**, 20-21 (2001).
- Micke, A. Genetic improvement of food legumes in developing countries by mutation induction, p.1031-1047, In: *World crops. Cool season food legumes* (Summerfield Rj,Ed.) Dordrecht, The Netherlands: Kluwer Academic Publishers (1988).
- Gaur, P.M., Gour, V.R. An induced fasciated mutants of chickpea (*Cicer arietinum* L.), *Indian J. Of Genet.* **59**, 325-330 (1999).
- Lowry, O.H., Rosebroough, N.J., Farr, A.L., Randall, R.J. Protein measurement with folin phenol reagent, *Biochemistry* **15**, 529-536 (1951).
- Sawhney, S.K., Naik, M.S., Nichola, D.J.D. Regulation of nitrate reduction by light, ATP and mitochondrial respiration in wheat leaves. *Nature* **277**, 647-648 (1978).
- Laemmli, H. Cleavage of structural protein during the assembly of the head of bacteriophage T4. *Nature* **227**, 680-685 (1970).
- Burton, G.W., De Vane, E.M. Estimating heritability in tall fescue (*Festuca arundinaceaea*) from replicated clonal material. *Agron. J.* **45**, 478-481 (1953).
- Hanson, C.H., Robinson, H.F., Comstock, R.E. Biometric studies of yield in segregating populations of korean and iespedeza. *Agron. J.* **48**, 268-272 (1956).
- Johnson, H.W., Robinson, H.F., Comstock, R.E. Estimates of genetic and environmental variability in soybean, *Agron. J.* **47**, 314-318 (1955).
- Kharkwal, M. C. Induced mutations in chickpea (*Cicer arietinum* L.) IV. Types of macro-mutation induced, *Indian J. Genet.* **60**, 305-320 (2000).
- Konzak, C.F., Nilan, R.A., Heiner, R.E. Control of factors affecting the response of plants to mutagens, *14th Brookhaven Symp. Biol.*, 128-57 (1961).
- Joshua, D.C., Bhatia, C.R. Increased cotyledonary cell size in induced large seed mutants in three grain legumes. *Environ Exp Bot.* **23**, 175-181 (1983).
- Toker, C., Cagirgan, M.I. Spectrum and frequency of induced mutations in chickpea. *ICPN*, **11**, 8-10 (2004).
- Ravikesavan, R., Kalaimagal, T., Ratiinaswamy, R. An extra early mutant of pigeonpea. *Mutation Breeding Newsletter* **45**, 19-20 (2001).
- Aparna, K., Munjal, S.V., Kale, A.A. Evaluation of nutritional composition of grains and leaf nitrate reductase activity in different maturity groups of pigeonpea. *J. Of Food Legume* **20**(2), 176-178 (2007).
- Badigannavar, A.M., Murty, G.S.S. Genetic enhancement of groundnut through gamma ray induced mutagenesis. *Plant Mutation Reports*, **1**(3), 16-21 (2007).

Gamma-Ray Induced Mutations in Soybean [*Glycine max* (L.) Merrill] for Yield-Contributing Traits

A B Tambe* & B J Apparao

Abstract

Attempts were made to induce genetic variability in yield contributing traits in soybean [*Glycine max* (L) Merrill] employing gamma radiation. Germplasm of a locally adapted cultivar of soybean, MACS-450 was irradiated with different doses (10, 20, 30, and 40 kR) of Gamma-rays and sown in the field during the kharif season of 2006. M₂ progeny was raised from the M₁ seeds, and was screened for yield contributing traits. The M₂ progeny raised from 30kR dose of gamma radiation exhibited several induced mutations for yield contributing traits. Important among them was a High-yielding mutant, of which about 10 mutant plants were obtained in the M₂ progeny. These High-yielding mutants were all uniformly tall and showed a two-fold increase in plant height. They produced double the number of pods per plant and thrice the yield per plant as compared to control. No change in pod length and number of seeds per pod were observed between the control and High-yielding mutant plants, except for the 100 seed weight, which was almost 1.5 times higher compared to the control. These mutants seem to be very promising in increasing the yield of soybean.

Introduction

Soybean is an important oil seed crop, cultivated in 64.50 Lakh hectares in India, as per estimates of 2003 [1]. Soybean provides a balanced diet to the poor to make up the deficiencies of proteins, fat, vitamins, minerals and salts and provide a nutritious diet, within the reach of the poorest in the country [2]. In spite of its nutritional importance, the yield of soybean is very low [3]. Mutation breeding is one of the plant breeding techniques used for creating genetic variability in yield contributing traits and to improve the yield of crop plants [4]. In the present investigation, attempts were made to improve the yield of the existing, locally adapted soybean cultivar MACS-450, by improving its yield-contributing traits through mutation breeding.

Materials and Methods

Experimental plant material used in the present investigation was soybean (*Glycine max* (L) Merrill) cultivar, MACS-450. The main features of the cultivar are its semi-determinate growth habit, medium maturity and high-yield potential. Germplasm of soybean (MACS-450) were obtained from Agarkar Research Institute, Pune. They were irradiated with different doses (10, 20, 30, and 40 Kr) of Gamma-rays at the Department of Biophysics Government Institute of Science, Aurangabad (Maharashtra State). Each treatment included 300 seeds, out of which 50 seeds were used for planting along with the control. Both irradiated and control (non-irradiated) seeds were sown in the experimental fields following randomized block design (RBD) with three replications, at a spacing of 15cm within rows and 45cm between rows, to raise the M₁ generation, during the kharif season of 2006. All the surviving M₁ plants were selfed

and harvested individually to give the M₂ generation population along with controls during kharif season of 2006-2007. Necessary cultural practices were adopted to produce a healthy crop. The M₂ progeny was raised following randomized block design with three replications.

Each treatment comprised of 20-21 M₁ plant progenies and each M₂ progeny row consisted of 10 to 25 plants in three replications. The cultural operations and application of FYM were done as per the standard schedule. Treated, as well as control plant progenies were carefully screened from the day of emergence, in all generations for the yield-contributing traits viz., plant height, number of branches per plant, number of nodes per plant, pods per plant, number of seeds per pod, pod length, 100 seeds weight, seeds per plant and yield per plant.



Figure 1 Field view (A) of dried specimens of control and of High-yielding mutants, (B) of soybean.

Results and Discussion

The M₂ progeny from the 30Kr dose of gamma radiation, exhibited several induced mutations for yield-contributing traits. Statistical analysis of data clearly indicated significant variations in yield-contributing traits of the mutant as compared to the control. The mutants were taller (98.48cm) than the control (49.10cm), and had double the number of nodes. No difference in number of branches was found between the control and mutants. The mutants produced double the number of pods and of seeds per plant as compared to the control (Fig. 2 and Table 1). The yield per plant in the mutants was almost three fold as compared to the control (Table 1). The difference in yield per plant observed between the control and mutant is statistically significant (Table 1). This mutant was named High-Yielding Mutant (Fig. 1 A and B). No change in pod length and number of seeds per pod was observed between the control and High-yielding mutants. The data recorded on M₂ generation are presented in Table 1.

The positive correlation between seed yield and number of pods observed in the present investigation is in agreement with results obtained by Anand and Torrie [5] and Lal and Haque [6]. A positive

Padmashri Vikhe Patil College Of Arts Science And Commerce ,Pravaranagar, A/Po.Loni (Kd),Tal. Rahata, Dist. Ahmednagar, Maharashtra ,India, PIN 413713

* Corresponding author. E-mail:anna_tambe@rediffmail.com

and significant correlation between the fertile branches and pods, fertile branches and seed yield and 100 seed weight and seed yield were also observed in M_2 the mutants. The positive and significant correlation between various quantitative characters of rice and soybean was reported earlier by Venkateswarulu, *et al.* [7] and Malhotra, *et al.* [8]. A negative and significant relationship between seed yield and 100 seed weight was also reported in chickpea by Baradjanegara, *et al.* [9]. Seed weight per plant was found to be positively associated with plant height [10]. The significance of each correlation was tested using t-test. The mutants seem to be very promising in increasing the yield of soybean. Such a high-yielding mutant, which yields almost three times as much as the existing locally adapted high-yielding variety (MACS 450) has not been reported so far. The present study confirms that Gamma-rays are highly effective in inducing polygenic variability for the yield contributing traits in soybean. A similar increase in yield parameters with Gamma-rays has been reported by Saric, *et al.* [11], Micke [12] and Sparrow [13]. These authors have attributed the increase in plant height to an increase in the number of growing points due to irradiation. Ionizing radiations are also known to induce a host of physiological changes in addition to genetic effects [14,15]. Such stimulatory effects were attributed to an increased enzymatic activity arising from a depletion of an inhibitor or an effect on the enzyme itself [14, 16].

Table 1. Yield-contributing traits of control and high yielding mutant at M_2 generation.

S.No	Parameter	Control	High-yielding Mutant
1	Plant height (cm)	49.10	98.48*
2	Number of branches per plant	09.40	09.90
3	Number of nodes per plant	13.20	24.10*
4	Pods per plant	97.40	244.40*
5	Number of seeds per pod	02.86	02.87
6	Pod length (cm)	5.01	5.39
7	100 seeds weight (gm)	12.985	17.857
8	Seeds per plant	278.6	702.3*
9	Yield per plant (gm)	36.134	125.447*

* Significant at P=0.001

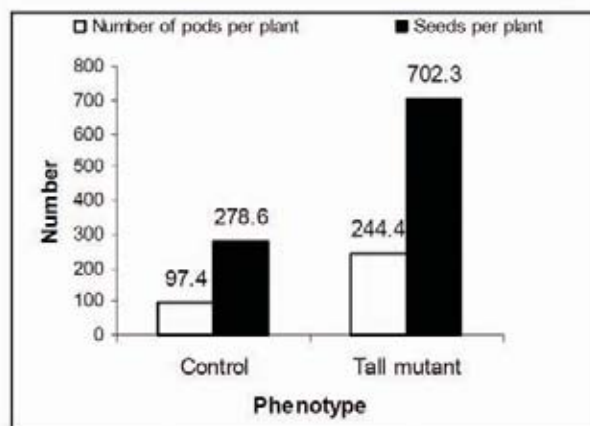

Figure 2 Number of pods and seeds per plant of control and High-yielding mutant of soybean.

These results on the induction of useful genetic variability for a number of economically important yield contributing traits, which can contribute to the development of high-yielding genotypes having an improved plant type, clearly indicate the vital role of mutation breeding in crop improvement. Systematic and serious efforts in pursuing the methodology of mutation breeding have already been successfully demonstrated in development and release of large number of improved high-yielding varieties in several crops [17].

ACKNOWLEDGEMENTS

We are thankful to Agharkar Research Institution, Pune, for providing the germplasm, Government Institute of Science, Aurangabad for extending irradiation facility and Dr. S.R. Walunj, Principal, Padmashri Vikhe Patil college, Pravaranagar for providing laboratory facilities.

BIBLIOGRAPHY

- Singh, B.B. The early challenges and pioneer promoters. Success of soybeans in India. *Asian Agri-History* **10**(1), 45 (2006).
- Rothod, S.D., Kamble, B.M., Chogule, B.A. Effect of grading screen size on physical properties. *Ad. Plant. Sci.* **20**(2), 487-490 (2007).
- Baradjanegara, A.A. Utilisation of fast neutrons and Gamma-rays for soybean improveckoordination. Mtgbangi, Kaulalumpur. IAEA-Tecdoc, Vienna. **234**, 41-43 (1979).
- Ahluwalia, B.S., Maluszynski M., Nichterlein K. Global impact of mutation-derived varieties. *Euphytica* **135**, 187-204 (2004).
- Anand, S.C., Torrie, J.H. *Crop Sci.* **3**, 508 (1993).
- Lal, V.S., Haque, M.F. *Indian J. Genet. Plant Breed.* **32**(2), 357 (1971).
- Venkateswarulu, B., Prasad, G.S.V., Prasad, A.S.V. Studies on nature of relationship between grain size spikelet number, grain yield and spikelet filling in late duration varieties of rice. *Plant And Soil* **60**, 123-130 (1981).
- Malhotra, R.S., Singh, K.B., Dhaliwal, H.S. Correlation and path coefficient analysis in soybean. **42**, 26-29 (1972).
- Baradjanegara, A.A., Lukman, Umer. Induced mutations for soybean improvement, induced mutations for improvement of grain legume production. In: IAEA-TecDoc, Vienna. **260**, 65-68 (1982).
- Kwon, S.H., Torrie, J.H. **4**, 196 (1964).
- Saric, M.R., Curie, F., Curie, H. Effect of Gamma irradiation in some varieties of wheat seed on the morpho-physiological characters of the seedlings in effects of ionizing radiations on seeds, IAEA, Vienna, 503-518 (1961).
- Micke, A. Comparison of the effect of x-rays and thermal neutrons on viability and growth of sweet clover *Melilotus alba* after irradiation of dry seeds. In: Effects Of Ionizing Radiations On Seeds, IAEA, 403-410.
- Sparrow, A.H. Plant Growth Stimulation By Ionizing Radiation. *IAEA Tech Rep Ser* **12**, 64 (1966).
- Gunckel, J.E. Ionizing radiations biochemical physiological and morphological aspects of their effects on plants. *Encyclopaedia Of Plant Physiology* **16**, 551-611 (1962).
- Plensnik, S. Study of some effects of laser radiation and ethyleneimine in model object soybean (*Glycine max* (L.) Merrill). *Genet Biol Mol* **23**, 49-58 (1991).
- Krausse, G.W., Werner, A. Study of the characteristics of selected induced mutants of soybean. *Archiv Zuchtangsforsch* **19**, 213-224 (1989).
- Kharkwal M. C., Pandey R. N., Pawar S. E. Mutation breeding for crop improvement. In: Plant Breeding-Mendelian To Molecular Approaches (H.K. Jain And M.C. Kharkwal, Eds). Narosa Publishing House P. Ltd., New Delhi, 601-645 (2004).

Induced Mutagenesis in Mungbean (*Vigna radiata* (L.) Wilczek)

S G Auti^{1,*} & B J Apparao²

Abstract

A wide range of viable morphological and physiological mutants were observed in M_2 and M_3 progenies of mungbean (*Vigna radiata* (L.) Wilczek) cultivars (Vaibhav and Kopargaon-1) raised from seeds treated with different concentrations of sodium azide, ethyl methane sulfonate and different doses of gamma radiation. The most striking type of mutants obtained in the M_3 progeny included plant habit, leaf structure, flower type, pod type, seed type, early-maturing and high-yielding and Lhb mutants. Some of these mutants are new and are being reported for the first time in this crop. The true breeding mutant lines of M_3 generation were compared with their parent cultivar (control) to assess whether the induced genetic variability was statistically significant. These mutants can be better fitted in new cropping patterns, with improved agronomic management and good yielding ability, or can be used in the genetic improvement of mungbean crop. Chemical mutagens were more efficient than physical ones in inducing viable and total number of mutations. Along with simple viable mutations, multiple mutagenic effects on two or more characters were also found in all the mutagenic treatments. Differences in the mutation frequency and spectrum depends on the interaction of three factors such as mutagen, plant genotype, and physiological state of the organism at the moment of treatment. The Kopargaon-1 cultivar was more resistant towards mutagenic treatment than Vaibhav cultivar. All mutants were analyzed for their protein, albumin and globulin contents by Lowry's method and for protein banding patterns employing SDS Polyacrylamide Gel Electrophoresis. Mungbean mutants with high as well as low protein contents ranging from 29.3% to 14.75% vis-à-vis 22.2% in the control were isolated. Results showed that early flowering mutant and Lhb mutant differed between each other as well as with other mutants and controls in their protein-banding pattern. Our results indicated that mutational breeding was effective and useful for induction of agronomically important mutants in mungbean.

Introduction

Induced mutations have been used to enhance genetic variability, which was utilized not only to increase crop productivity but also for basic studies in various crops [1]. Induced mutagenesis has played an important role in improvement of mungbean, and as many as 25 cultivars have been developed so far through induced mutagenesis [2]. In order to induce variability and utilize useful mutations for efficient plant breeding, the systematic study of induced viable morphological mutations in M_1 and M_2 generation is the most dependable index [3].

Material and Methods

The experimental plant material used in the present investigation were two local varieties of mungbean (*Vigna radiata* (L.) Wilczek); Vaibhav

and Kopargaon-1. These two cultivars were treated with different concentrations of two chemical mutagens; ethyl methane sulphonate (EMS) and sodium azide (SA) and one physical mutagen, gamma radiation, to induce mutations in the M_2 and M_3 progenies of the selected plant materials. Stock solutions EMS (1.0M) and sodium azide (1.0M) were prepared in phosphate buffer (pH. 3.5). From these stocks, working solutions of 0.01, 0.02, 0.03, and 0.04 M concentrations each of EMS and SA were prepared. The seeds were surface sterilized with 0.1% mercuric chloride solution for about one minute, washed thoroughly and soaked in distilled water for eight hours. Pre-soaked seeds were subjected to treatment with various test concentrations of EMS and SA for 12 hours at room temperature. The source of gamma radiation used in this study was ⁶⁰Co. Dry seeds of Vaibhav and Kopargaon-1 (about 700 each) were irradiated with 30, 40 and 50 kR doses of gamma radiation. Treated as the control, seeds were sown in the experimental fields at a spacing of 30 x 20cm apart on the same day.

Each M_1 plant was harvested individually and M_2 progeny was raised in separate rows. The treated and control populations of M_2 generation were carefully screened for viable mutations and spectrum of mutation was counted in M_2 and is presented in **Tables 1 and 2**, respectively. Total proteins, globulin and albumin were estimated in three replications following the method of Lowry, *et al.* [4] and Polyacrylamide Gel Electrophoresis was carried out following the method of Laemmli [5].

Results and Discussion

Frequency and spectrum of viable mutations

Mutations affecting gross morphological changes in leaf morphology, plant habit, flowers, pods, days to first flower and maturity, high yield, the same as mutations affecting seed color, size and shape, were scored as viable mutations. These mutants were characterized and named on the basis of specific characters constantly observed in them throughout the course of the investigation. Effect of mutagens on the frequency and spectrum of different types of viable mutations in both cultivars of mungbean in M_2 generation is presented in Tables 1 and 2. Various types of viable mutants observed in M_2 generation are described below.

Plant type mutations

Four classes of viable plant type mutations were observed in the M_2 progeny of mungbean cultivars Vaibhav and Kopargaon-1: tall, dwarf, compact mutations and spreading mutant.

i. Tall mutant: Plants were exceptionally tall (75 to 96cm. vs. 49-51cm in the control) and vigorous. Tall mutants could be observed in both varieties after treatment with different concentrations of SA and EMS. They appeared with a frequency of 30.21% in Vaibhav and 6.18% in Kopargaon-1.

ii. Dwarf mutant: Plants were dwarf, ranging from 32 to 35cm in height vs. 49-51cm in the control, and they remained dwarf throughout the growth period. They showed profuse branching at the base, normal flowers and pods. Dwarf mutants were induced by all concentrations of SA, EMS and all doses of gamma radiation in both varieties.

¹ Department of Botany, H. P. T. Arts and R. Y. K. Science College, Nashik. Maharashtra State, India, PIN 422005

² Padmashri Vikhe Patil College of Arts, Science and Commerce, Pravaranagar, At/Po. Loni (Kd), Taluka Rahata, District Ahmednagar, Maharashtra state, India, PIN 413 713.

* Corresponding author. E-mail: autisanjay@yahoo.co.in

They appeared with a frequency of 34.14% in Vaibhav and 22.08% in Kopargaon-1.

iii. Compact mutant: These mutants were dwarf due to compactness of branches. The branching was more at the base, giving rise to dense, interwoven secondary branches, which ultimately made the mutant compact. This type of mutant was induced by 50 kR dose of gamma radiation with a frequency of 1.64% and they were recorded only in Vaibhav variety.

iv. Spreading mutant: This type of mutants showed spreading or semi-spreading habit. They were induced by 40 kR dose of gamma radiation with a lowest frequency of 0.70%. Pods of spreading mutants were small (3.5 to 4cm) and bore faint colored grains. They were found only in Vaibhav variety.

Leaf mutations

A broad spectrum of leaf mutations with remarkable variation in shape, size, number and arrangement of leaflets were observed with various mutagenic treatments.

i. Broad leaf: The leaflets were larger in size with broad lamina. The plants ranged from 60 to 86cm high and had pollen sterility up to 22%. Frequency of this type was 13.5% in variety Vaibhav and 7.33% in Kopargaon-1, and were induced by 0.02 M and 0.03 M of sodium azide and EMS.

ii. Leathery leaves: The leaflets were thick, leathery and showed waxy coating on the surface. Plants attained a height up to 55-58cm and the flowers were normal and had a pollen sterility up to 15%. These mutations appeared in Vaibhav with a frequency 0.93 and in Kopargaon-1 with a frequency 3.69. These were induced by 0.04 M EMS, and all concentrations of gamma radiations.

iii. Irregular leaves: These mutants were characterized by the presence of leaves with notched leaflets and irregular shape of the lamina. In most leaves, the notch appeared in the middle of the leaflets. Plants were of medium height but were weak in nature. The pods were small and possessed smaller seeds. Rate of seed germination was very low and plant had up to 73% pollen sterility. These mutants appeared in Vaibhav and Kopargaon-1 with a high frequency of 18.58% and 14.15%, respectively.

iv. Dissected leaves: The lamina of the leaves was dissected in a specific pattern (Fig. 1). The pods were small and seeds were faint green in color. They appeared in both varieties with a frequency of 2.12% in Vaibhav and 0.74% in Kopargaon-1, with 40 kR dose of gamma radiation.

v. Tetrafoliate leaves: This type of mutants produced leaves with four leaflets. All four leaflets were different in shape and the leaves showed different arrangements. The plants produced normal flowers, bore medium pods and had pollen sterility up to 15%. The plant height was 60-65cm. They appeared in Vaibhav and Kopargaon-1, with a frequency 6.78% and 5.11%, respectively.

Flower mutations

Four different types of flower mutations viz., large flower size, small flower mutations, flower color and abnormal (stamen) flower mutations were observed in the M_2 progeny of mutagen administered mungbean cultivars. All the doses of gamma radiations were effective in inducing flower mutations. Flower mutations were recorded only in the variety Vaibhav.

Pod mutations

Five types of pod mutations were observed in the M_2 progeny following mutagenesis as follows:

i. Long Pod Mutant: The pods of these mutant plants are long (9.8 to 10.1cm) as compared to those of the control (6.9 to 7.9cm), and contained medium-size green seeds. This type of long pod mutations was observed in M_2 progeny subjected to treatment with different concentrations of SA and EMS. They were recorded in Vaibhav variety with a

frequency of 19.14% and in Kopargaon-1 with 21.15%. EMS induced higher frequencies of mutations in both varieties.

ii. Curved pod: This type of mutation was characterized by the presence of medium to small sized pods, which were curved and possessed small seeds. This type of mutation was recorded with a frequency of 12.12% in Vaibhav and 15.34% in Kopargaon-1, as a result of treatment with different concentrations SA and EMS and all the doses of gamma radiation.

iii. Hairy pod: This mutation was characterized by thick, dense and hairy pods (Fig. 2). The pods turned black at maturity and contained black seeds. This type of mutation was recorded only in Vaibhav variety, with a frequency 2.34% as a result of treatment with a 50 kR dose of gamma radiation.

iv. Flat pod: These pods contained small seeds. The mutants were late in maturity (91 days). They were induced by 0.03 and 0.04M concentrations of SA and EMS and all the doses of gamma radiation with a frequency 8.96% only in Kopargaon-1 variety.

v. Pod Color: This type of mutant pods had a pod wall of different colors, ranging from dark green to brown and black. Such mutations in pod color were recorded in Vaibhav variety only. EMS (0.02M) and gamma radiations (40 kR) were effective in inducing pod color mutations with a frequency of 3.14% and 1.83%, respectively.

High-yielding mutants

High-yielding mutants were isolated in M_2 generation of both varieties. They showed high yield contributing characters viz. number of pods, 100 seed weight and yield per plant. These mutants were induced only by lower concentrations of chemical mutagens in Vaibhav and Kopargaon-1 varieties with the frequencies 3.83% and 2.98%, respectively.

Mutations affecting seed color, size and shape

A large number of seed mutations were isolated in M_2 generation. Many of these mutations were associated with other characteristics such as dwarfness, various types of leaf morphological modifications, plant type mutations, etc. Mutations of seed shape and size included small, bold, small with rough seed coat, bold with rough seed coat, wrinkled seeds, elongated seeds, etc. The seed color mutations included black, faint brown, dark green and reddish brown (Fig. 3).

Several workers have reported induction of viable mutations employing physical and chemical mutagens in mungbean [6, 7]. In our studies, EMS has emerged as a more effective mutagen than sodium azide and gamma radiation, in terms of mutation spectrum. Comparison of the spectrum of viable mutation had shown that particular mutagens induced specific mutations in a relatively large number, which was produced rarely by other mutagens. The variation in mutation frequency, within and between treatments noted in the present study may be due to the number of genes involved in the mutational process. A 50 kR dose of gamma radiation induced a novel mutant that showed multiple morphological mutations like large flowers with dark yellow petals, dense, thick hairy pods and black colored seeds. It was named Lhb mutant (large flower, hairy pod and black seed mutant). Such a mutant had not been reported earlier in mungbean. These Lhb mutants were also recovered in M_3 populations of mungbean. Lhb mutants also showed multiple mutagenic effects on various other traits. The Lhb mutant raised through gamma radiation-induced mutagenesis in the present research seems to be promising in at least for two characters i.e., semi-dwarf habit and presence of thick dense hairs on the pods. The semi-dwarf habit of the plant enables it to be lodging resistant. The thick dense hairs on the pod help in protecting it from insects and caterpillar predators and may be an economically promising and important character. It can be used or incorporated in breeding programmes that are aimed at genetic improvement of mungbean. According to Patil [8], multiple mutations are either due to mutation of a pleiotropic gene, mutation of gene clus-

ters, or to a loss of chromosomal segments. Leaf, flower, pod and seed mutations obtained in the present investigation might have arisen as a result of mutations in the genes that control the ontogeny of these organs through their gene products and altered biosynthetic pathways. Among the stable mutants only high-yielding mutants showed high levels of proteins, amino acids, albumins and globulins followed by tall and dwarf mutants (Table 3). The large seeded mutants may be utilized in breeding programmes as donors. The early maturing mutant exhibited the presence of 12 polypeptide bands while the Lhb mutant showed the presence of nine polypeptide bands (Fig. 4). These bands differed from those of control and other mutants in position and molecular weight. This difference in banding pattern of these two mutants (early-maturing and Lhb mutants) can be used as molecular markers to identify them from other mutants and controls. These mutants are promising and can be used in breeding programmes of mungbean aimed at genetic improvement of protein, albumin and globulin contents in the mungbean genotypes.

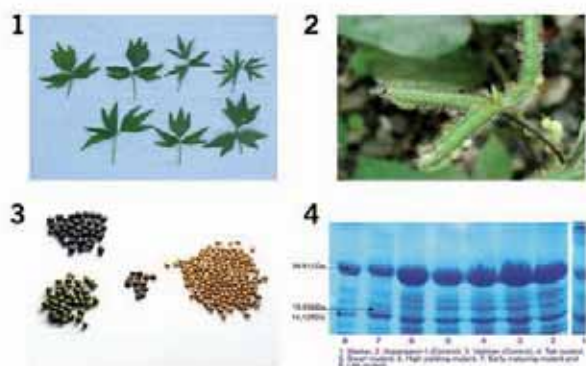

Figure 1-4 1. Dissected mutant leaves; 2. Hairy pod mutant; 3. Seed mutants; 4. Electrophoregram of mungbean mutants.

Table 1. Frequency of induced viable mutations (in%) in M₂ progeny of mungbean cv. Vaibhav.

Treatment	Total mutation Frequency (%)	Plant type mutations	Leaf mutations	Flower mutations	Pod mutations	Seed mutations	Maturity type mutations
SA							
0.01M	2.22	0.44	0.22	-	0.44	0.66	0.44
0.02 M	3.01	0.46	0.69	0.23	0.46	0.69	0.46
0.03 M	3.85	0.45	0.90	0.22	0.68	1.13	0.45
0.04 M	2.74	0.45	0.68	0.22	0.45	0.45	0.45
EMS							
0.01M	2.91	0.44	0.44	-	0.67	0.89	0.44
0.02 M	4.64	0.46	1.16	0.23	0.69	1.16	0.92
0.03 M	4.90	0.44	1.32	0.66	0.89	1.11	0.44
0.04 M	4.35	0.45	1.37	0.45	0.68	0.91	0.45
Gamma							
30 kR	2.55	0.23	0.69	0.23	0.46	0.69	0.23
40 kR	3.52	0.23	0.47	0.69	0.69	0.69	0.47
50kR	4.21	0.46	0.70	0.93	0.93	0.70	0.46

Table 2. Frequency of induced viable mutations (in%) in M₂ progeny of mungbean cv. Kopargaon-1.

Treatment	Total mutation Frequency (%)	Plant type mutations	Leaf mutations	Flower mutations	Pod mutations	Seed mutations	Maturity type mutations
SA							
0.01M	1.13	0.45	0.22	0.45	-	-	0.44
0.02 M	2.51	0.45	0.68	0.68	-	0.68	0.46
0.03 M	2.92	0.22	0.67	0.9	0.67	0.45	0.45
0.04 M	2.79	0.23	0.69	0.69	0.69	0.46	0.45
EMS							
0.01M	1.60	0.45	0.45	0.45	0.22	-	0.44
0.02 M	3.71	0.46	0.16	0.46	0.69	0.92	0.92
0.03 M	3.29	0.23	1.41	0.70	0.70	0.23	0.44
0.04 M	2.95	0.22	1.36	0.68	0.68	-	0.45
Gamma							
30 kR	2.15	0.23	0.71	0.71	-	0.47	0.23
40 kR	3.19	0.24	1.23	0.73	0.49	0.49	0.47
50kR	2.5	0.25	0.5	0.75	0.5	0.5	0.46

Table 3. Variation in the protein, globulin and albumin contents of mungbean mutants.

Mutants	Protein Mean (%)	Globulin Mean (%)	Albumin Mean (%)	Mutants	Protein Mean (%)	Globulin Mean (%)	Albumin Mean (%)
Vaibhav				Kopargaon-1			
Control	22.2	12.7	10.2	Control	21.36	12.76	10.2
Tall mutant	23.3	13.3	10	Tall mutant	21.5	12.26	8.5
Dwarf mutant	24.7	13.1	9.2	Dwarf mutant	22.1	11.46	9.23
High yielding	29.3	16.1	13.7	High yielding	26.46	14.43	12.76
Dissected leaf	19.5	10.4	7.2				
Early maturing	23.4	11.7	9.8	Early maturing	21.26	12.7	9.56
Late maturing	17.5	9.3	5.7				
Variiegated leaf	14.7	7.3	5.1				
Lhb mutant	18.9	10.5	6.4				
S.E.	0.35	0.37	0.26	S.E.	0.65	0.16	0.42
C.D. at 5%	1.04	1.12	0.78	C.D. at 5%	2.13	0.54	1.38
C.D. at 1%	1.43	1.54	1.07	C.D. at 1%	3.1	0.79	2

ACKNOWLEDGEMENTS

We are thankful to Mahatma Phule Agricultural University, Rahuri, for providing the germplasm and thankful to University Grants Commission, New Delhi for the financial assistance.

BIBLIOGRAPHY

- Chopra, V.L., Sharma, R.P. Induced mutations in crop improvement. In: Genetic manipulation for crop improvement. Oxford and IBH publishing Co., New Delhi. p.23-48 (1985).
- Pandey, R.N., Reddy K.S., Dhanasekar, P. Induced mutations in mungbean: A review. *J. Arid legumes* 2(2), 314-324 (2005).

3. Kharkwal M.C. Induced mutations in chickpea (*Cicer arietinum* L.) IV. Types of macromutations induced. *Indian J. Genet.* **60**(3), 305-320 (2000).
4. Lowry, O.H., Rosebrough, N.J. , Farr, A.L., Randall, R.J. Protein measurement with folin phenol reagent. *Biochemistry* **15**, 529-536 (1951).
5. Laemmli, H. Cleavage of structural protein during the assembly of the head of bacteriophage T4. *Nature* **227**, 680-685 (1970).
6. Khan Mackey, Samiullah, Mohd Rafiq Wani, Kouser Parveen. Induced Genetic Variability for Quantitative traits in *Vigna radiata* (L.) Wilczek. *Pak J. Bot.* **36**(4), 845-850 (2004).
7. Singh, V.P., Singh, Man, Lal, J.P. Gamma ray and EMS induced genetic variability for quantitative trait in urdbean (*Vigna mungo* Hepper). *Indian J. Genet.* **60**(1), 89-96 (2000).
8. Patil, S.H. Mutations induced in groundnut by X-rays. *Indian J. Genet. Pl. Breed.* **26**(A), 334-348 (1966).

Genetic Enhancement of Groundnut (*Arachis hypogaea* L.) for High Oil Content through Gamma-Ray Mutagenesis

A Badigannavar* & S Mondal

Abstract

Breeding for increased oil content (OC) is important in groundnut since 70% of the Indian groundnuts are utilized for oil purpose. To induce mutations for higher OC, seeds of TAG 24 were irradiated with 150, 250 and 350Gy Gamma-rays. OC in M_3 seeds from M_2 plants estimated by Nuclear Magnetic Resonance Spectrometer, ranged from 36.39% to 52.85% as compared to 43.38% to 50.83% in the parent. In the M_2 , 60 plants had superior OC as well as seed yield, 46 plants had superior OC and 62 plants had superior oil yield. Based on OC and seed yield, 107 plants were advanced. Progeny mean OC in M_4 seeds indicated 14 progenies bred true by recording 1.5 - 4.9% higher OC than parent. Of these, 11 progenies also recorded superior seed yields of 3.0 - 86.0% and oil yields of 6.2 - 92.4%. Further in the M_5 generation, four mutants scored significantly higher progeny mean OC, seed yield and oil yield with 2.4 - 5.8%, 46.6 - 67.8% and 54.4 - 71.2% superiority, respectively. True breeding behavior of high oil mutants was confirmed by progeny evaluation in M_6 generation. All the mutants had significantly superior OC with three mutants having greater seed and oil yields. Genetic improvement for OC was brought about by Gamma-ray mutagenesis of TAG 24, wherein seven mutants exhibited consistently superior OC of 4.3 - 6.1% based on pooled mean from M_3 to M_6 generations, in addition to an improved seed yield and oil yield. Thus, induced mutagenesis was successful in bringing about genetic improvement for a complex trait like oil content in groundnut.

Introduction

Groundnut (peanut) is an important food, feed and oilseed crop and contributes 27.7% to Indian and 8.5% to world's oilseed production [1]. Among vegetable oils, groundnut oil stands in second position in India and fifth in the world, contributing 21% and 4% respectively to total oil availability. Around 46% of global groundnuts are crushed for oil purpose while in India the rate is at 70%. Per capita consumption of groundnut oil in India (1.568 kg) is almost double that in the rest of the world (0.778Kg). Frequent groundnut consumption promotes cardiovascular health by lowering serum LDL-cholesterol levels and reduces the risk of development of type II diabetes [2].

Groundnuts are valued for their high quality oil, rich in monounsaturated fatty acids like oleic acid. Most of the oil is found in the cotyledons, which form 72.4% of the seed. Groundnut oil is considered an excellent cooking medium in Indian culinary, as it does not impair the flavour of herbs and spices by contributing its own. Besides, it can be stored at room temperature for 18 months without deterioration [3]. Though modifications for oil quantity in induced mutants of *Brassica* spp. [4-5], *Gossypium* spp. [6], *Arachis hypogaea* [7-8], *Glycine max* [9] and *Helianthus annuus* [4,10] were reported, there were no concentrated

studies for breeding for improved oil content using induced mutagenesis. Here, we report breeding for oil content in cultivated groundnut using Gamma-ray induced mutagenesis.

Materials and Methods

For the induced mutagenesis, a popular groundnut variety, TAG 24 was irradiated with 150, 250 and 350Gy Gamma-rays (500 seeds each) and sown in the field along with 100 untreated seeds [11]. M_1 generation was raised and all the plants were harvested individually dose-wise. Seed oil content (OC) was estimated by Nuclear Magnetic Resonance (NMR) Spectrometer (Oxford MQA 6005 Model, Oxford Instruments UK Ltd., Oxan, UK). Seed sample size was standardized initially by analyzing OC of single, two, three and more sound mature seeds until they reached the mark on glass tube of NMR. Sound mature M_3 seeds from 2781 M_2 plants (1872 plants in 150; 511 in 250 and 398 in 350 GY) were used for estimating OC by NMR. Mutant populations were advanced as plant to row progeny in M_4 , M_5 and M_6 generations and OC was estimated progeny-wise in each generation. Progeny means for OC of mutants were compared with parent using t-test in each generation.

Results and Discussion

Since 70% of the Indian groundnuts are utilized for oil purpose, breeding for increased oil content is an utmost important objective in groundnut breeding programmes. Increased oil yield is achieved by increased seed yield and/or increasing oil content. Based on results of oil estimation by NMR for two seasons for two genotypes, TAG 24 and TG 18A, it was found that oil content (OC) was stable from a sample size of 10g to 18g. Accordingly, 10-18g of sound mature seeds was analyzed for the OC.

In order to achieve increased oil content, induced mutagenesis of TAG 24 was carried out using Gamma-rays. It was found that mean oil percentage in the entire 150, 250 and 350Gy treated and parental populations was between 45% and 47%. There was a spectrum of genetic variability for oil content in the M_2 population (M_3 seeds). The widest range of oil content of 36.39 - 52.85% was observed in the 150Gy treatment, compared to 43.38 - 50.83% in TAG 24, followed by 350 and 250Gy (Table 1). The highest was 52.85% oil, noted from plants obtained by 150Gy treatment. In this M_2 population, 60 plants had superior oil content (50.40 - 52.72%), as well as seed yield (19.3 - 44.7g plant⁻¹), 46 plants had superior oil content (48.52 - 50.36%) and 62 plants had superior oil yield (9.5 - 22.1g plant⁻¹) compared to TAG 24 (oil content: 46.47%; seed yield: 18.3g plant⁻¹; oil yield: 8.5g plant⁻¹). Based on seed yield and OC, a total of 107 plants were advanced to the next generation.

Of the 107 progenies grown, 14 progenies bred true for high oil content by recording 1.5 - 4.9% increase in mean oil content of M_4 seeds over parent. Among these, 11 progenies also recorded superior seed yields of 3.0 - 86.0% and oil yields of 6.2 - 92.4% compared to TAG 24. TGOM 142 recorded the highest mean oil content (51.55%) and TGOM 61 recorded the highest seed yield (43.9 g plant⁻¹) and oil yield (22.1g plant⁻¹). Further, 10 plants (TGOM 167 to TGOM 176) with oil content 50.00 - 56.18% were selected and harvested separately.

Nuclear Agriculture and Biotechnology Division, Bhabha Atomic Research Centre, Trombay, Mumbai - 400085, India

* Corresponding author. E-mail: anandgnut@yahoo.co.in

In an evaluation in M_3 generation, TGOM 2, TGOM 60, TGOM 61 and TGOM 168 scored significantly higher progeny mean oil content with a superiority of 2.4 - 5.8% (Fig. 1). Additionally, TGOM 61, TGOM 119, TGOM 168 and TGOM 171 recorded significantly greater seed and oil yields with 46.6 - 67.8% and 54.4 - 71.2% increase over parental mean, respectively (Fig. 2, 3). Further, TGOM 61 had the highest oil content, while TGOM 119 had the highest seed and oil yields.

Table 1. Frequency distribution of number of M_2 plants in oil content classes

Oil%	TAG 24	150GY	250GY	350GY
36.00 - 36.99		3		
37.00 - 37.99		2		
38.00 - 38.99		10	5	4
39.00 - 39.99		6	5	2
40.00 - 40.99		25	12	15
41.00 - 41.99		44	4	23
42.00 - 42.99		103	19	37
43.00 - 43.99	3	221	38	45
44.00 - 44.99	6	366	63	62
45.00 - 45.99	6	391	112	62
46.00 - 46.99	5	282	133	65
47.00 - 47.99	3	149	67	37
48.00 - 48.99	2	87	26	26
49.00 - 49.99	2	76	22	10
50.00 - 50.99	3	63	5	7
51.00 - 51.99		32		2
52.00 - 52.99		11		1
Total plants	30	1872	511	398
Mean	46.47	45.58	45.73	45.1
Range	43.38 - 50.83	36.39 - 52.85	38.54 - 50.46	38.24 - 52.47
SD	2.09	2.38	2.08	2.43
S Em±	0.382	0.055	0.092	0.122

True breeding behavior of high-oil mutants was confirmed by studying their performance in M_6 generation. All seven mutants had significantly superior oil content with the highest oil percentage in TGOM 119 (Fig. 1). Among these, TGOM 60, TGOM 61 and TGOM 119 also recorded greater seed and oil yields with 27.3 - 35.3% and 29.8 - 48.4% superiority, respectively (Fig. 2, 3). However, oil content in TGOM 167 was higher than TAG 24 while its seed and oil yields were inferior. Genetic improvement for oil content was brought about by induced mutagenesis of TAG 24, wherein mutants TGOM 2, TGOM 60, TGOM 61, TGOM 119, TGOM 167, TGOM 168 and TGOM 171 exhibited consistently superior oil content in M_3 to M_6 generations. These mutants had an improved mean oil content of 4.3 - 6.1% compared to the parent. Additionally, except TGOM 167, these mutants also registered an improved seed yield and oil yield of 13.3 - 42.1% and 18.6 - 50.2%, respectively. TGOM 171 was obtained with 250Gy treatment while rest of the mutants with 150Gy.

Thus, induced mutagenesis was successful in bringing about genetic improvement for a complex trait like oil content. In the literature, it was reported that oil content varied from 36.0 to 60.3% in cultivated groundnut and from 42.2 to 63.2% in wild species based on the genotype, seed maturity, environment, post-harvest treatment, insect or disease incidence, time of planting and harvesting, planting density, plant nutrition, and irrigation. In inter-mutant groundnut crosses, an improvement for oil content was observed due to a combination of favourable genes resulting in increased genetic variance in mutated backgrounds [12].

Through pollen mutagenesis using ethyl methane sulfonate (EMS), Jiang and Ming [13] produced maize mutants with high oil contents. Oil content in developing seeds increased due to an increase in the number of oil bodies without changing in size [14]. Wang, *et al.* [15] found that lipase activity was proportional to the oil content in high oil and low oil maize lines. Increased seed oil content may also result from partitioning of increased amounts of photosynthates into the embryo and decreased amount into hull. In safflower, the oil content was raised from 20% to 48% due to reduced hull content [16]. In *Arabidopsis* mutants, the high oil phenotype is caused by the disruption of the GLABRA 2 gene which encodes a homeobox protein required for normal trichome and root hair development [17].

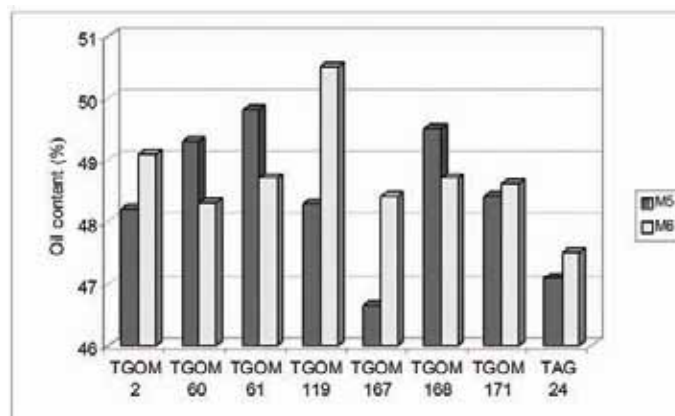

Figure 1 Mean progeny oil content in induced mutants in M_5 and M_6 generations.

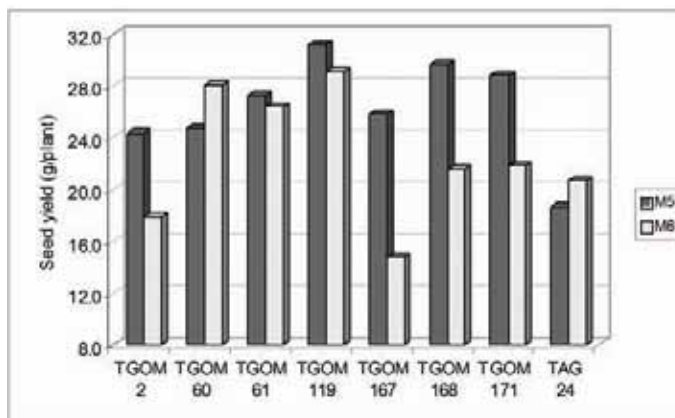

Figure 2 Mean progeny seed yield in induced mutants in M_5 and M_6 generations.

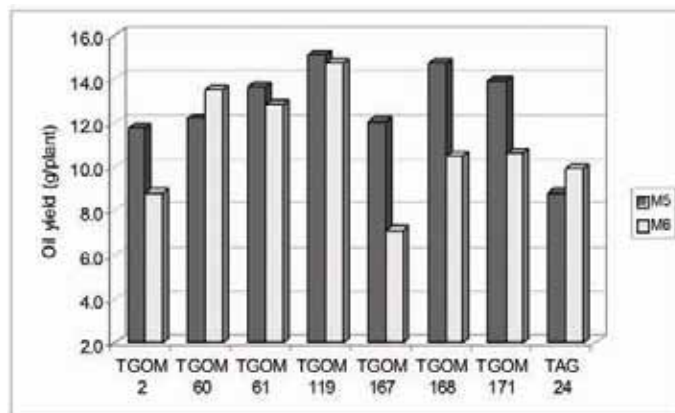

Figure 3 Mean progeny oil yield in induced mutants in M_5 and M_6 generations.

BIBLIOGRAPHY

1. United States Department Of Agriculture from Oilseeds: World Markets And Trade. Foreign Agricultural Service, United States Department Of Agriculture, Circular Series Fop 6-08 (2008).
2. Kris-Etherton, P.M. *et al.* High-Monounsaturated Fatty Acid Diets Lower Both Plasma Cholesterol And Triacylglycerol Concentration, *Am. J. Clin. Nutri.* **70**, 1009 (1999).
3. Misra, J.B. Nutritive Value Of Groundnut And Composition Of Indian Groundnut Cultivars, Groundnut Research In India, (Basu, M.S., Singh, N.B. Ed.). National Research Centre For Groundnut, Junagadh, p.488 (2004).
4. Joshua, D.C., Jambhulkar, S.J. Use Of Induced Mutations And Biotechnology To Tailor Industrial Crops For New Crop Rotations And Quality Improvement, IAEA-Tecdoc-1369, Vienna, 9-16 (2003).
5. Shah, S.A. *et al.* 'Nifa-Mustard Canola'- First Mutant Variety Of Oilseed Mustard (Brassica Juncea Coss & Czern.) In Pakistan, *Mutation Breeding Newsl. Rev.* **1**, 22 (2005).
6. Abo-Hegazi, A.M.T. *et al.* Use Of Mutations To Improve Cotton Plants As An Oil And Protein Source Without Affecting The Seed Cotton Yield, Plant Mutation Breeding For Crop Improvement, Vol. II, IAEA, Vienna, 183-187 (1991).
7. Mouli, C. *et al.* Induced Mutants Of Groundnut Cultivar, Phule-Pragati, *Current Sci.* **56**, 1237 (1987).
8. Dwivedi, S.L. *et al.* Induced Genetic Variation For Seed Quality Traits In Groundnut, *Int. Arachis News Lett.* **18** (1998) 44.
9. Wang, L.Z. *et al.* Combining Radiation Mutation Techniques With Biotechnology For Soybean Breeding, IAEA-Tecdoc-1369, 107 (2003).
10. Vranceanu, A.V., Luoras, M. Mutagenesis In Sunflower (*Helianthus Annuus* L.) Breeding, Plant Mutation Breeding For Crop Improvement Vol. I, IAEA, Vienna, 431 (1991).
11. Badigannavar, A.M., Murty, G.S.S. Genetic Enhancement Of Groundnut Through Gamma-Ray Induced Mutagenesis. *Plant Mutation Reports* **1**(3), 16 (2007).
12. Patil, S.H. Trombay Groundnut Selections For Increased Oil Content And Their Comparative Yield Performances. *Indian J. Agric. Sci.*, **43**, 370 (1973).
13. Jiang, C.S., Ming, S.T. High Oil Mutants From Ems Pollen Mutagenesis In Maize. *J. China Agril. Univ.*, **7**(3), 12 (2002).
14. Ohlrogge, J., Browse, J. Lipid Biosynthesis. *Plant Cell*, **7**, 957 (1995).
15. Wang, S.M. *et al.* Lipase Activities In Scutella Of Maize Lines Having Diverse Kernel Lipid Content. *Plant Physiol.* **76**, 837 (1984).
16. Urie, A.L. Inheritance Of Partial Hull In Safflower. *Crop Sci.* **26**, 493 (1986).
17. Shen, B. *et al.* The Homeobox Gene *Glabra 2* Affects Seed Oil Content In *Arabidopsis*. *Plant Mol. Biol.* **60**, 377 (2006).

Development and Utilization of Genetic Variability through Induced Mutagenesis in Sunflower (*Helianthus annuus* L.)

S J Jambhulkar* & A S Shitre

Abstract

Studies on mutation breeding at Bhabha Atomic Research Center (BARC), Mumbai, India, were initiated with the objective of isolating black seed coat mutant from zebra striped seed coat variety 'Surya' whose yield potential is equivalent to hybrids. Besides black seed coat mutants, a large number of morphological mutants were isolated. Prominent among them are a fasciation stem mutation and an extreme dwarf mutant, each controlled by a single recessive gene. One of the dwarf mutants had a 90cm plant height with sturdy stem. Furthermore, variations in number, shape, and size of ray florets were also isolated. In seed coat color black, white, and brown colored mutations were isolated. Seed and oil yields of one of the black seed coat mutant genotype TAS82 were superior over three checks. Also, TAS82 was relatively tolerant to sunflower necrosis disease (SND) and tolerant to low rainfall conditions. Based on these superior characters, it was identified for release in the state of Maharashtra and notified by the government of India in 2007. Morphological and biochemical mutations isolated in other laboratories along with genetic control are also mentioned here.

Introduction

Sunflower is one of the youngest cultivated crop plants. Wild sunflower is native to North America. In India, it was introduced in the 1960s. The cultivated area is around 1.8-2 mha and it ranks fourth after groundnut, rapeseed-mustard, and soybean. Present yield potential of 10-12q/ha has been exploited through the development of hybrids using cytoplasmic male sterility. However, changing nutritional requirements and environmental vagaries have imposed new trust areas for sunflower improvement programmes. Genetic improvement through induced mutagenesis in sunflower could pave the way to develop desirable varieties/hybrids with higher seed and oil yields, better nutrition, and tolerance to biotic and abiotic stresses. Mutation breeding has been successful for induction of desirable variability and its utilization in developing high-yielding varieties [1, 2, 3]. Compared to self-pollinated crops, mutation breeding in sunflower has been limited. However, efforts to enhance the spectrum of variability for morphological, biochemical, yield and its attributes have been carried out [4, 5, 6, 7]. Mutation breeding in sunflower is briefly overviewed in this article.

Morphological mutations

Plant height, stem, leaf, and head (inflorescence) are the important sunflower morphological characters. Inflorescence consists of ray and disc florets. Mutations in various morphological characters are presented in Table 1. Most of these mutations are controlled by single recessive genes.

Work carried out at BARC

Mutation studies were initiated in 1991 with the objective of isolating black seed coat mutants from the zebra-striped seed coat variety 'Surya'

Nuclear Agriculture & Biotechnology Division, Bhabha Atomic Research Center, Mumbai-400085.

* Corresponding author. E-mail: sjj@barc.gov.in

whose yield potential is equivalent to hybrids. Besides 7 black seed coat mutants, a large number of morphological mutants were isolated [7]. Prominent among them are a fasciation mutant [16] with 125 leaves against 30-35 in the parent and an extreme dwarf mutant [12] with a plant height of 11cm against 180cm of the parent. Single recessive genes control each of these mutations. Various morphological mutations are controlled by either a recessive or dominant or additive gene [14] and could be exploited in sunflower improvement programmes. Dwarf and semi-dwarf mutants avert lodging and stalk breakage and they have prominence in breeding [24]. One of the dwarf mutants of 'Surya', which grows to 90cm with a sturdy stem, is being exploited to develop dwarf hybrid/varieties.

Table 1. Various morphological mutations and their inheritance.

Character	Mutant	Genetic control	References
Chlorophyll	chlorophyll deficient Xantha, virescent Yellow leaf veins		[8],[9] [7]
Plant height	Reduced plant height Extreme dwarf (11cm)	Recessive Additive & dominance Single recessive	[10] [11] [12]
Leaf	Basilicum leaf Upright leaf Leaf curling Wrinkled & involuted Spoon-like leaf roll More leaf number	Single dominant Single recessive Single recessive - Single recessive Quantitative	[13] [14] [7] [4] [4]
Leaf petiole	Erectum Short petiole	Single recessive Two complementary dominant Two cumulative dominant	[4] [4] [15]
Leaf color	Dark green color	Two complementary dominant	[4]
Stem	Zigzag stem	-	[7]
Stem and leaf	fasciation stem fasciation	Single recessive Single recessive	[16] [17]
Inflorescence (Ray & Disc florets)	Chrysanthemoides (<i>chry</i>) Tubular ray flower Reduced, zigzag, short Broad, thin & more ray florets Reduced ray florets Various shades Color shades	Semi-dominant w modifiers - - Single recessive - Two unlinked pairs of alleles - -	[18] [19] [4] [20],[21] [7] [4] [4] [21], [22]
Cotyledon	Tricotyledon	-	[23]

In seed coat color black, white, and brown seed coat mutations were isolated. Black seed coat mutants were exploited to develop high yielding varieties as preferred in the market. Sib-mating of seven black seed coat mutants resulted in the development of high yielding genotypes. Seed yield of one of the mutant genotypes TAS 82 (1348 Kg/ha) was superior

by 17.42%, 12.05% and 53.53% over checks PKVSF9 (1148Kg/ha), Surya (1203 Kg/ha) and Morden (878 Kg/ha), respectively. Oil yield of TAS 82 (528kg/ha) was also superior by 32%, 20% and 78% over check varieties, PKVSF9 (397kg/ha), Surya (440kg/ha) and Morden (296Kg/ha), respectively. Other morphological characters were similar to 'Surya'. Besides, TAS 82 was relatively tolerant to sunflower necrosis disease (SND) and yielded better in low rainfall conditions. Based on these superior characters it was identified for release in the state of Maharashtra and notified by Ministry of Agriculture, Government of India in 2007. Induced mutations for yield and yield components and their use in breeding were carried out since 1973 [6]. In the USSR, 'Pervenets' is the only high yielding variety developed using DMS [33].

Mutations for fatty acids

Edible oil constitutes an important component in human diet and acts as main energy source. In sunflower oil oleic (30%) and linoleic (60%) acids contribute more than 80% of the total fatty acids. From a nutritional point of view, increased oleic acid (70%) and decreased linoleic acids (20%) are desirable. Various mutations for fatty acid content have been isolated [1],[5] and are listed in Table 2.

Table 2. Mutations for various fatty acids.

Fatty acids	Parent	Mutagen	Mutant	References
Palmitic acid	Zarya RHA274	Gamma-rays NMU/EMS	275HP (25.1%) <i>fap1</i> low	[25] [26], [27]
	BDS 2-691	X-rays	CAS5 (25.2%)	[28], [29]
	BSD-2-423	X-rays	CAS5, CAS12 increased	[30], [31]
Stearic acid	HA821	NMU/ EM	Low Stearic	[27]
	RHA 274	NMU/ EMS	M430 (2%) Low	[26]
	RHA 274 LS-2	NMU/ EMS	Low Stearic	[27]
	RDF 1-532	EMS/ Na ₃ Sodium Azide	CAS3,CAS4,CAS8 incr. CAS14	[28] [32]
Oleic acid	V1M1K-8931	DMS	Pervenets (79.3%)	[33]
	HA382 (18.9%)	EMS/ NMU	M4229 (86.2%)	[26]
	BSD-2-423	X-rays	CAS12 reduced	[30]

BIBLIOGRAPHY

- Bhatia, C.R. *et al.* Oilseed cultivars developed from induced mutations and mutations altering fatty acid composition. *Mutation Breeding Review*. **11**, 1-36 (1999).
- Ahloowalia, B.S., *et al.* Global impact of mutation-derived varieties. *Euphytica* **135**, 187-204 (2004).
- Chopra, V.L. Mutagenesis: investigating the process and processing the outcome for crop improvement. *Curr. Sci.* **89**(2), 353-359 (2005).
- Luczkiewicz, T. Inheritance of some characters and properties in sunflower (*Helianthus annuus* L.). *Genetica Polonica*. **16**(2), 167-184 (1975).
- Robbelen, G. Mutation breeding for quality improvement: A case study for oilseed crops. *Mutation Breeding Review* **6**, 1-44 (1990).
- Vranceanu, A.V., Stoenescu, F.M. Achievements and prospects of sunflower genetics, breeding and induced mutation utilization. In: Improvement of oilseed and industrial crops by induced mutations, IAEA, Vienna, 431-437 (1982).
- Jambhulkar, S.J., Joshua, D.C. Induction of plant injury, chimera, chlorophyll and morphological mutations in sunflower using gamma rays. *Helia* **22**, 63-74 (1996).
- Leclercq, P. Heredite de quelques caracteres qualites chez le tournesol. *Ann. Amelior Plantes* **18**, 307-315 (1968).
- Mihaljicevic, M. Chlorophyll deficient mutant in sunflower. 1. Mendelian inheritance (Proc. Symp. Pisa), 1152-1157 (1992).
- Fick, G. N. Sunflower breeding and genetics, Sunflower Science and technology (Carter, J. F., Ed.) *Agron. Monograph* **19**, 279-337 (1978).
- Miller, J.F., Hamond, J. Inheritance of reduced height in sunflower. *Euphytica* **53**, 31-136 (1991).
- Jambhulkar, S.J. An extreme dwarf mutant in sunflower. *Curr. Sci.* **83**, 116 (2002).
- Pugliesi *et al.* Inheritance of the basilicum leaf mutation in sunflower (*Helianthus annuus* L.) *J. Heredity* **86**(1), 76-77 (1995).
- Miller, J.F. Update on inheritance of sunflower characteristics, (Proc. Conf. Pisa), Vol. 2, 905-945 (1992).
- Vranceanu, A.V. *et al.* Genetic study of short petiole trait and its use in sunflower breeding (Proc. Symp. Toowoomba, Australia), 429-434 (1988).
- Jambhulkar, S.J. Growth morphology and inheritance of fasciation mutation in sunflower. *J. Genet & Breed* **56**, 327-330 (2002).
- Fambriani, M. *et al.* Stem fasciated, a recessive mutation in sunflower (*Helianthus annuus*), alters plant morphology and auxin level. *Ann. of Bot.* **98**, 715-730 (2006).
- Fambriani, M. *et al.* Missing flowers gene controls axillary meristem initiation in sunflower. *Genesis* **36**, 25-33 (2003).
- Berti *et al.* Mutations of corolla symmetry affect carpel and stamen development in *Helianthus annuus*. *Can. J. Bot.* **83**(8), 1065-1072 (2005).
- Fambriani *et al.* The unstable tubular ray flower allele of sunflower: inheritance of the revision to wild type. *Plant Breeding* **126**, 548-550 (2007).
- Fick, G.N. Genetics of floral color and morphology in sunflower. *J. Heredity* **67**, 227-230 (1976).
- Heiser, C.B. Taxonomy of *Helianthus* and origin of domesticated sunflower, Sunflower Science and Technology (Carter, J. F. Ed.) *Agron. Monograph* **19**, 31-53 (1978).
- Hu, J. *et al.* Registration of a tricotyledon sunflower genetic stock, *Crop Sci.* **46**, 2734-2735 (2007).
- Schneider, A.A. Production of semidwarf and dwarf Sunflower in the northern great plains of United States. *Field Crops Research* **30**, 391-401 (1992).
- Ivanov, I.A. *et al.* Sunflower breeding for high palmitic acid content in the oil, In: 12th Intern. Sunflower Conf. International Sunflower Association, Novi Sad. 463-465 (1988).
- Vick, B.A., Miller, J.F. Utilization of mutagens for fatty acid alteration in sunflower. In: Proc. 18th Sunflower Research Workshop. National Sunflower Association, Fargo, 11-17 (1996).
- Miller, J.F., Vick, B.A. Inheritance of reduced stearic and palmitic acid content in sunflower seed oil. *Crop Sci.* **39**, 346-367 (1999).
- Osrio, J.J. *et al.* Mutant sunflowers with high concentration of saturated fatty acids in the oil. *Crop Sci.* **35**, 739-742 (1995).
- Perez-Vich *et al.* Inheritance of high palmitic acid content in the seed oil of sunflower mutant CAS-5. *Theor. Appl. Genet.* **98**, 496-501 (1999).
- Fernandez-Martinez *et al.* Sunflower mutant containing high levels of palmitic acid in high oleic background. *Euphytica* **97**, 113-116 (1997).
- Martinez-Force *et al.* Enzymatic characterization of high palmitic acid sunflower mutants. *Planta* **207**, 533-538 (1999).
- Fernandez-Moya, V. *et al.* Temperature effect on a high stearic acid sunflower mutant. *Phytochemistry* **59**, 33-37 (2002).
- Soldatov, K.I. Chemical mutagenesis in sunflower breeding (Proc. Conf. Krasnodar, Russia) Vol 1., 352-357 (1976).

Genetic Improvement of Soybean Variety VLS-2 through Induced Mutations

J G Manjaya

Abstract

The narrow genetic base of cultivated varieties in soybean is of global concern. Mutations, spontaneous or induced, are an important source of genetic variability. Seeds of soybean cultivar VLS -2 were irradiated with 250Gy Gamma-rays. A large number of mutants with altered morphological characters like plant height, flower color, sterility, leaf shape, number of pods per plant, seed color, early or late maturity were identified and characterized. Significantly higher oil content was observed in the mutant M-387 (22.7%) and dwarf mutant M-126 (20.7%) as compared to the parent VLS-2 (19.7%). A modified rapid and reliable micro titration plate technique was developed and used for screening trypsin inhibitor (TI) content in the seeds of 7480 M_2 plants. The TI content in the M_3 generation ranged from 13.5 TIU/mg seed meal to 22.9 TIU/mg seed meal. Significantly lower level of TI was observed in the mutants M-104 (13.5 TIU/mg seed meal), M-213 (14.0 TIU/mg seed meal) and M-291 (15.7 TIU/mg seed meal) as compared to the parent VLS-2 (22.4 TIU/mg seed meal). In the M_3 generation, 24 mutant lines were evaluated for various quantitative characters. Analysis of variance showed highly significant variations among mutant lines for yield per plant. Mutant M-17 had the yield per plant of 13.1gm, significantly higher than the parent VLS-2 (8.3 gm). This mutant also exhibited more branches, more pods and higher harvest index. Genetic diversity study indicated that mutant M-17 had maximum dissimilarity value of 24% from the parent. These identified mutants can be utilised in the breeding programme for developing elite varieties of soybean.

Introduction

Soybean [*Glycine max* (L.) Merrill] is an economically important leguminous crop for oil, feed, and soy food products and since 2005 it has occupied first position among the oilseed crops grown in India; it shares nearly 37% of the total oilseeds produced and is cultivated over an estimated area of 8.87 million hectares with a production of around 9.46 million tons. Considering the economic importance of the soybean, crop genetic research on soybean has increased and with the help of conventional plant breeding procedures, dramatic improvements have been accomplished in Indian soybean cultivars. So far more than 93 soybean varieties have been released in India for commercial cultivation. However, the productivity remains only 1t/ha in India as compared to world average of 2.2t/ha. In India, along with various other factors, narrow genetic base of the released soybean varieties is responsible for low average yields [1].

Soybean is found to be associated with a number of anti-nutritional factors that exert a negative impact on the nutritional quality of the protein [2]. Protease inhibitor is one of the important anti-nutritional factors that exert a negative effect by causing pancreatic hypertrophy, hyperplasia which ultimately results in the inhibition of growth. The

presence of protease inhibitors is a limitation for the use of soybeans in human and animal feeding. Soybean needs to undergo heat treatment in order to reduce protease inhibitors; however, thermal treatment does not eliminate the inhibitor completely and also reduces its economic viability as a food supplement [3]. Hence, development of cultivars with low trypsin inhibitors (TI) will help to improve nutritional quality of soybean for export and domestic use.

Improvement in yield is normally attained through exploitation of the genetically diverse genotypes in breeding programmes. Mutations, spontaneous or induced, are an important source for inducing genetic variability. Improvement in either a single or a few economic traits and quality characters can be achieved with the help of induced mutations within a short time span. In India, six soybean varieties (Birsa soy 1, VLS-1, NRC-2, NRC-12, MACS-450 and TAMS 98-21) have been developed using induced mutations. Therefore, attempts were made to induce genetic variability for morphological characters, yield attributes, and oil and trypsin inhibitor content in the soybean cultivar VLS-2.

Materials and Methods

Plant material and mutation studies

One thousand seeds of the soybean variety VLS-2 were exposed to 250Gy Gamma-rays in a gamma cell GC 220 with ^{60}Co source installed at BARC. The treated seeds along with the parental control were sown in the experimental field at Trombay to raise the M_1 generation. The data on germination was recorded at three to 12 days after sowing. In all, 748 M_1 plants were harvested individually and the seeds obtained were used to raise the M_2 population in plant to row progenies. In M_2 generation, 7,480 plants were carefully screened for morphological mutations. Plants appearing different from the control for one or more morphological traits were harvested separately. The frequency of the mutants was calculated on the basis of number of mutants identified versus total plant population. In the M_3 generation, 24 mutants for different traits were evaluated for various quantitative characters in comparison to the parental cultivar VLS-2.

Determination of oil and protein content

Oil content of seed samples was determined by solvent extraction using Soxhlet apparatus [Soxtec system – HT (1043)]. The nitrogen content of the seed was determined by the micro-Kjeldahl method [4] and the amount of total protein was calculated from percent nitrogen content using a conversion factor of 6.25.

Analysis of trypsin inhibitor content

One hundred milligrams of ground seed meal/ powder was mixed with 1 ml of 2.5mM HCl and shaken for 30 minutes. The suspension was centrifuged at 25,000g for 10 minutes at 4°C. The supernatant was collected and used for analyzing the TI as described by Page, *et al.* [5]. The TI activity assay was carried out in micro titer plates in duplicate. The first two wells had 10 μ l of trypsin, 80 μ l Tris-HCl buffer pH 8, 5 μ l seed extract,

Nuclear Agriculture and Biotechnology Division, Bhabha Atomic Research Centre, Trombay, Mumbai 400 085, India

E-mail: manjaya@barc.gov.in

25µl of 30% acetic acid (to inhibit the trypsin) and 125µl of BAPNA. The last two wells of the row had 10µl trypsin, 85µl Tris-HCl buffer pH 8, 5µl (Tris-HCl buffer, 2.5mM HCl in the ratio of 1:1) and 125µl of 1mM BAPNA. The first two wells of the row were considered to be blank and the last two wells were considered as control (100% trypsin). For measuring the TI activity of the sample, two adjacent wells of the micro titer plate were used. The wells had 10µl trypsin, 85µl Tris-HCl buffer, 5µl seed extract and 125µl of 1mM BAPNA. After 30 minutes, the reaction was stopped by adding 25µl of 30% (v/v) acetic acid. The absorbance of each well was measured at 405nm in an ELISA reader. One TIU is defined as an increase of 0.01 absorbance unit at 405nm under the above described conditions. One TIU corresponds to one unit of trypsin inhibited.

Statistical methods

Significance of various observations was tested using standard statistical methods. Analyses of variance were calculated as described by Panse and Sukhatme [6]. Statistical analysis of the morphological characters of mutants was conducted using the programme Numerical Taxonomy Analysis System, version 2.00 [7].

Table 1. Frequency and spectrum of mutants in M₂ generation in the cultivar VLS-2

Character of the mutant	No. of plants selected in M ₂	Frequency%
Chlorophyll		
Albina	7	0.09
Xantha	35	0.47
Chlorina	69	0.92
Leaf size and shape		
Round	7	0.09
Narrow	7	0.09
Small	38	0.02
Sterile	2	0.05
Plant characters		
Dwarf	80	1.07
Good bearing	32	0.43
High oil	26	0.34
High Protein	1	0.01
Low Trypsin inhibitor	3	0.04

Results and Discussion

Studies in M₁ and M₂ generations

Studies on effectiveness and efficiency based on undesired effects like plant damage, sterility or lethality of the physical and chemical mutagens have been carried out in soybean by several workers. Various parameters like germination percentage, reduction in plant height and plant survival in M₁ generation have been extensively used in soybean to measure the mutagenic effect [8]. In our studies, the germination rate observed in the M₁ generation was 74.8%. In the M₂ generation, chlorophyll and viable mutants affecting morphological and physiological characters were identified and selected. The frequency and the spectrum of the mutants in the M₂ generation are given in **Table 1**. Chlorophyll mutations occur with high frequency following mutagenic treatments of seeds. They are regarded as the test mutations assuming that their frequency is proportional to the rate of viable mutations. Various chlorophyll mutations like albino, xantha, chlorina, virescent, maculata and striata have been observed in soybean [9]. The various chlorophyll mutations observed in the present investigation were albino, xantha, virescent and chlorina. The morphological mutants included those affecting plant height, steril-

ity, leaf shape and number of pods per plant. All 7,480 M₂ plants of the cultivar VLS-2 were screened for oil content using the NMR technique. In the parent, oil content was 19.9% while in the selections it ranged from 13.9% to 24.61%. Twenty-six selections with higher oil content ranging between 23% to 24%, identified and mutation frequency was 0.35% (**Table 1**). Trypsin inhibitor activity was estimated in the seeds of 7,480 M₂ plants of the cultivar VLS-2 by microtitration plate technique. These studies have indicated considerable variation regarding the TI level and it ranged from 28.5 TIU/mg seed meal to 13.7 TIU/mg seed meal. All the selections showing low TI as compared to parent VLS-2 (21.8 TIU/mg seed meal) were identified (Constantin, *et al.*) [10], observed decrease in survival, plant height and seed yield with increase in dose rate of mutagen and found 200 to 300Gy of gamma radiation to be useful in inducing genetic variability in soybean. In another study 100 to 300Gy dose of Gamma-rays was found very effective for inducing genetic variability [11]. In the present study also 250Gy Gamma-rays dose was found effective for inducing genetic variability in the cultivar VLS-2.

Evaluation of mutants of VLS 2

Twenty-four mutants in the M₂ generation were evaluated for various quantitative characters in comparison to the parental cultivar VLS-2. Mean values for important morphological characters are shown in **Table 2**. The mean plant height of the parent cultivar VLS-2 was 22.5cm. The plant height in the mutants ranged from 12.0cm to 21.5cm (**Fig. 1**) (**Table 2**). Extreme dwarf mutant M-494 (**Fig. 2**) showed plant height of 12.0cm. Multi-branch mutant M-17 showed significantly higher number of pods and high harvest index as compared to the parent VLS-2. Analysis of variance showed highly significant variation among the mutants for yield per plant. Yield per plant ranged from 2.8gm to 13.1gm as compared to the parent VLS-2 (8.3gm). Only one mutant M-17 showed high yield per plant 13.1gm (**Table 2**). Induced mutations for quantitative traits [12], leaf and floral modifications [9, 13 and 14] have been reported.

High oil content was observed in the mutant M-387 (22.7%) and dwarf mutant M-126 (20.7%) as compared to the parent VLS-2 (19.7%) (**Table 1**). Mutants with higher oil content have been reported by other workers as well [15]. Protein content in the mutants ranged from 36.7% to 41.7%. Dwarf mutant M-60 demonstrated highest seed protein (41.7%) as compared to the parent VLS-2 (39.7%).

A simple, reliable method of screening a large number of plants for identifying biochemical mutants is a pre-requisite for an efficient breeding programme. In the present study, a rapid and reliable microtiter plate technique was developed and used for assaying TI activity. Three mutants namely M-213 (13.7 TIU/mg seed meal), M-104 (15.4 TIU/mg seed meal) and M-291 (15.9 TIU/mg seed meal) showed lower levels of TI content as compared to parent VLS-2 (21.8 TIU/mg seed meal) (**Table 2**). One of the mutants M-225 (28.5 TIU/mg seed meal) showed higher TI content as compared to the parent. Low TI mutants identified using this technique can be used in the cross-breeding programme for developing low TI lines.

Genetic diversity studies of soybean mutants

Induced mutants affecting quantitative characters have been studied in soybean [12]. The coefficient of variation was found to be higher in mutants of soybean induced by Gamma-rays [16]. In the present study, six major clusters were observed based on dissimilarity values between mutants of VLS-2 (**Fig. 3**). A maximum of eight mutants was grouped in Cluster III followed by seven mutants in Cluster I. Cluster II, Cluster IV and Cluster V had three mutants each. Only one mutant M-17 was grouped in cluster VI and had maximum dissimilarity value of 24% from the parent. Based on the present study the mutant M-17 was found distinct and diverse and can be utilized in the breeding programme for developing better varieties of soybean.

Table 2. Morphological and biochemical characters of VLS-2 mutants in M₅ generation

M-16	31	95	16.1	20.4	14.7	17.9	40.0	16.8	38.5	6.9
M-17	32	95	17.9	36.6	16.0	19.0	39.7	20.3	48.2	13.1
M-22	31	95	12.5	21.1	12.0	18.8	39.1	20.0	31.6	4.1
M-26	31	96	17.0	27.8	15.4	18.5	40.2	19.8	34.9	9.0
M-40	31	95	16.5	19.4	16.5	17.7	40.5	17.6	33.5	4.7
M-51	31	96	19.2	22.9	15.0	18.5	40.7	17.9	38.9	6.2
M-60	31	95	13.0	8.5	14.8	16.9	41.7	18.3	31.6	3.3
M-104	31	95	17.4	24.8	15.6	19.4	38.9	13.5	42.6	8.4
M-126	31	96	15.7	17.4	15.7	20.7	37.7	16.3	31.6	4.6
M-170	31	95	18.8	14.7	15.4	18.4	39.9	19.4	33.5	5.0
M-180	32	95	14.0	28.3	15.8	18.0	40.0	22.3	41.6	7.4
M-213	31	95	18.3	17.1	15.2	17.7	40.0	14.0	35.9	4.6
M-225	32	96	14.8	20.1	15.9	18.4	38.6	20.9	41.5	7.4
M-226	31	97	13.3	7.9	14.3	19.2	37.7	18.4	31.5	5.5
M-229	31	95	15.0	15.0	16.4	19.4	36.7	21.7	29.7	3.6
M-231	32	96	15.8	14.8	15.5	17.9	40.5	20.6	21.3	3.6
M-235	31	95	17.0	18.3	16.4	17.7	40.4	22.9	42.3	4.8
M-285	31	96	17.0	9.4	14.2	18.9	39.7	21.4	22.8	2.8
M-291	31	96	17.3	15.4	15.4	18.9	38.9	15.7	35.0	3.9
M-387	31	96	17.5	26.0	16.1	22.7	37.1	18.2	47.1	7.2
M-450	31	96	21.5	19.0	15.2	18.7	40.0	17.3	36.0	6.5
M-468	31	96	12.5	15.2	15.6	19.3	36.9	20.4	46.3	8.7
M-494	31	96	12.0	25.3	14.2	18.5	39.6	20.0	44.4	7.2
M-624	32	96	21.5	27.9	16.5	18.3	37.3	21.8	41.0	7.9
VLS-2	31	95	22.5	24.9	15.6	19.7	39.7	22.4	39.8	8.3
SE			0.4	1.3	0.3	0.3	0.5	1.5	1.6	0.8
CD 5%			1.3	3.9	1.0	0.8	1.5	1.6	4.5	2.4
CD 1%			1.8	5.3	1.4	1.1	2.0	2.1	6.1	3.2
CV%			3.8	9.5	3.3	2.14	1.85	4.05	5.9	18.5



Figure 1 Comparison of dwarf mutants



Figure 2 Extreme dwarf mutant

In the breeding programme, hybridization provides unlimited possibilities of generating new combinations of characters, which can be selected in the segregating population. In contrast, with induced mutations it is possible to improve a single trait without causing extensive disruption in the genome. The use of mutation techniques for crop improvement over the past few decades has shown that it is an effective plant breeding method to improve yield, quality and resistance to biotic

and abiotic stresses. Thus induced mutations can be widely accepted as a supplementary approach in the crop improvement programme, thus speeding up the breeding programme considerably. The results also indicated that a dose of 250Gy Gamma-rays is useful to induce broad genetic variability in soybean. The other mutants identified may be a useful genetic stock for applied and basic research.

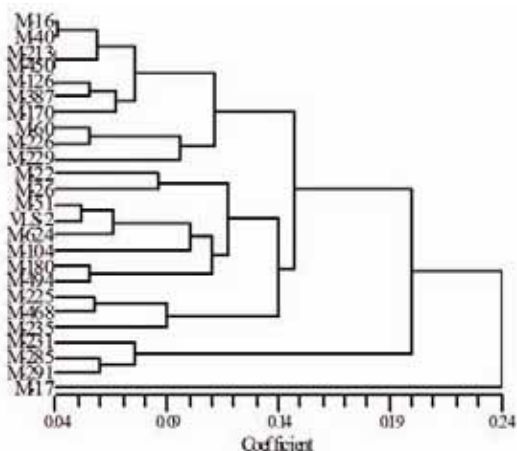

Figure 3 UPGMA dendrogram obtained from dissimilarity index values.

ACKNOWLEDGEMENTS

The author gratefully acknowledges the help and technical guidance rendered by Dr T. Gopalakrishna, NABTD, BARC.

BIBLIOGRAPHY

- Satyavathi, C.T. *et al.* Ancestral Analysis Of Soybean Varieties: An Overview, *Indian J. Genet.* **63**, 87 (2003).
- Liener, I. E. Implications Of Antinutritional Components In Soybean Foods, *Crit. Rev. Food Sci. Nutr.* **34**, 31 (1994).
- McNiven, M. A. Biochemical Characterization Of A Low Trypsin Inhibitor Soybean. *J. Food Sci.* **57**, 1375 (1992).
- A.O.A.C., Official Methods Of Analysis. Association Of Official Agricultural Chemistry, Washington, D.C., (1984).
- Page, D. *et al.* Trypsin Inhibitor Activity Measurement: Simplifications Of The Standard Procedure Used For Pea Seed. *Crop Sci.* **40**, 1482 (2000).
- Panse, V.G., Sukhatme P.V. Statistical Methods For Agricultural Workers. I.C.A.R., New Delhi, (1978).
- Rohlf, F. J., Ntsys. Pc Numerical Taxonomy And Multivariate Analysis System, Version 2.02. Applied Biostatistics, New York (1990).
- Mehetre, S.S. *et al.* Induced Genetic Variability And Character Association In Soybean. *Crop Res. (Hisar)* **8**, 348 (1994).
- Wakode, M.M. *et al.* Radiation Induced Mutagenesis In Soybean (*Glycine Max* L. Merrill). In: Dae – Brns Symposium On The Use Of Nuclear And Molecular Techniques In Crop Improvement. Dec. 6 – 8, 2000. Mumbai, p.113, (2000).
- Constantin, M.J. Mutation Induction In Soybean. *Mut Breed Newslett.* **9** (1974).
- Manjaya, J.G., Nandanwar, R.S. Genetic Improvement Of Soybean Variety Js 80-21 Through Induced Mutations. *Plant Mutation Reports* **1**, 36 (2007).
- Kundi, R.S. *et al.* Radiation Induced Variability For Quantitative Traits In Soybean (*Glycine Max* (L.) Merrill). *Crop Improv.* **24**, 231 (1997).
- Singh, B.B., Jha A.N. Abnormal Differentiation Of Floral Parts In A Mutant Strain Of Soybean. *J. Hered.* **69**, 143 (1978).
- Smutkupt, S. Observations Of Unstable Genes Of Flower And Seed Coat Colors In Soybean Derived From A 'Wakashima' Mutant. *Soybean Genet. Newslett.* **23**, 120 (1996).
- Bhatnagar, P.S. *et al.* Disrupting The Negative Association Between Oil And Protein Content In Soybean Seeds Through Mutagenesis. *Mut Breed Newslett.* **39**, 7 (1992).
- Rajput, M.A. *et al.* Variability For Some Quantitative Traits In Soybean. *Soybean Genetic Newslett.* **14**, 113 (1987).

Concurrent Session 2

DNA Damage, Repair and Genome Stability

Characterization of Two H2AX Homologues in *Arabidopsis thaliana* and their Response to Ionizing Radiation

N D Huefner^{1,*}, J D. Friesner² & A B Britt¹

Abstract

Phosphorylation of histone variant H2AX at the site of DNA double-strand breaks (DSB) is one of the earliest responses detected in cells exposed to Ionizing Radiation (IR). Phosphorylated H2AX (γ -H2AX) is important for recruiting and retaining repair proteins at the site of DSBs and contributes to the maintenance of cell-cycle arrest until repair is completed. In this study, insertional mutants of two *Arabidopsis thaliana* H2AX homologues were identified and characterized to determine if both genes are functionally active and whether their roles are redundant or divergent. We report an approximate ten-fold reduction in γ -H2AX in our double mutant line and demonstrate that the homologues function redundantly in the formation of IR induced γ -H2AX foci. A tendency towards increased inhibition of root growth was observed in irradiated double mutant plants relative to both wild-type and single mutant lines. No evidence indicating a functional divergence between the two homologues was detected.

Introduction

Protection against genomic instability is of major importance to all organisms. Failure to rapidly identify or appropriately respond to DNA damage can lead to deletions, chromosomal rearrangement, and loss of heterozygosity; such changes are frequently deleterious and potentially lethal. DNA double-strand breaks (DSBs), both of intrinsic and extrinsic origin, constitute one significant source of genomic instability. Metabolic byproducts [1, 2], ionizing radiation (IR) [3, 4], radiomimetic compounds [4-6], and meiosis [7] are all known to generate DSBs. Given the fundamental importance of a timely and reliable response to DSBs, it is not surprising that a high degree of homology exists between DSB recognition and repair pathways in yeasts, plants, and animals [8, 9].

One of the earliest observed responses to induction of DSBs is phosphorylation of the histone variant H2AX by the PIK-related protein kinase (PIKK) family member ataxia telangiectasia mutated (ATM) and to a lesser extent by ataxia telangiectasia mutated and rad3-related (ATR) [10-12]. This histone variant, characterized by a terminal SQE motif, is phosphorylated within minutes of induction of a DSB [13]. Phosphorylation of H2AX at the site of a DSB is thought to be important in retaining and concentrating repair proteins at the site of the break [14-16]. Evidence indicates that phosphorylated H2AX, termed γ -H2AX [17], also plays a role in recruiting chromatin modifiers to the lesion to facilitate repair [18]. Following repair, dephosphorylation of γ -H2AX is important for the cell to resume cycling [19, 20].

H2AX is highly conserved among eukaryotes [21]. Two putative H2AX protein homologues were identified in the model plant *Arabidopsis thaliana* [10]. These homologues, termed *H2AXa* (GenBank locus At1g08880) and *H2AXb* (GenBank locus At1g54690) are predicted to

differ at only two of 142 amino acids. Here we demonstrate that *atH2AXa* and *atH2AXb* function redundantly in the formation of IR induced γ -H2AX foci; no divergent roles for the two homologues were observed.

Materials and Methods

Isolation of Mutants

Arabidopsis thaliana T-DNA insertion mutants of *atH2AXa* (At1g54690) and *atH2AXb* (At1g54690) were obtained from the SAIL collection ('SALK_007006.29.20.x', and 'SALK_012255.55.25.x' respectively) through the ABRC. The T-DNA-specific primer used in the isolation of both mutants was 'LBa1' (5'-TGGTTCACGTAGTGGGCCATCG-3'). The gene-specific primer used in the detection of *atH2AXa* was 'AL1' (5'-GCTCCATGAGTTGCATGTATCTGC-3'). The gene-specific primer used in the detection of *atH2AXb* was 'BL2' (5'-CTCTTCATCGTTCCTCACTGCAAG-3'). The T-DNA insertion site of *atH2AXa* was sequenced using primers 'LBa1' and 'AL1' for one left border and 'LBa1' and 'AU1' (5'-TCGATCAACCCTGGCCATCTT-3') for the second left border. Primers 'LBa1' and 'BL2' were used to sequence the left border T-DNA integration site in *atH2AXb*. Gene-specific primers 'AL2' (5'-ACGTGCTTCTTGTATCCCTTGC-3') and 'AU2' (5'-CCTAAAGCCCCTCATCTTC-3') were used to detect the wild-type allele of *atH2AXa*. Gene-specific primers 'BL1' (5'-CTCTTGAGAAGCAGATCCGATATCGC-3') and 'BU1' (5'-CCGCGTGACTCACAACCAAT-3') were used to detect the wild-type allele of *atH2AXb*.

Plant Material and Growth Conditions

Plants used in this study were of a *Col* background. Plants used for protein extraction were grown on Premier Pro soil mix (Premier Horticulture, Quebec, Canada). Seeds to be used for root tip excisions and for root growth measurements were surface sterilized for 10 minutes in a solution of 20% bleach and 0.2% Tween, and then rinsed 10 times in ddH₂O. Sterilized seeds were sown on nutritive MS-agar plates and stored at 4°C for three days before being transferred to normal growing conditions. Plates were placed in a vertical orientation so that roots would grow along the surface of the agar. Plants were grown at 20°C and 60% humidity in ConvironcmP4040 growth chambers. A 16 h day/8 h night cycle was simulated using light from cool-white lamps (100-150 $\mu\text{mol m}^{-2} \text{s}^{-1}$) filtered through Mylar.

Gamma Irradiations

A Cs137 source (Institute of Toxicology and Environmental Health, University of California, Davis) was used to irradiate seeds at a dose rate of 6.9Gy sec⁻¹. Plants used for protein extraction were irradiated with 100 or 200Gy IR or mock-treated 14 days after planting (DAP). Above ground tissue was harvested into liquid nitrogen 15 minutes after treatment and stored at -80°C until the time of protein extraction. Seedlings used in root tip excisions were irradiated with five or 2.5Gy IR or mock-treated 5 DAP; samples were fixed in paraformaldehyde five minutes

¹ Section of Plant Biology, University of California-Davis, Davis, CA 95616, USA

² Section of Molecular and Cellular Biology, University of California -Davis

* Corresponding author. E-mail: ndhuefner@ucdavis.edu

after treatment and the root tips excised as described below. Seedlings used in root growth assays were irradiated with indicated doses 5 DAP.

Protein Extractions and Immunoblots

Histones were harvested as described previously [22]. Sodium fluoride (Sigma, St. Louis, MO) and sodium ortho-vanadate (Sigma) were used at final concentrations of 30 mM and 100 μ M respectively to inhibit dephosphorylation of proteins. Extracts were quantified using the Bradford assay and prepped for immunoblotting as previously reported [10]. Protein samples were separated on a 12.5% polyacrylamide gel and then transferred to nitrocellulose membranes over a period of four hours at 4°C in 20% methanol transfer buffer under a constant current of 400 mA. Blots were stained for five minutes in Ponceau S (P-3504, Sigma) solution to qualitatively evaluate protein loading and transfer. Blots were destained and transferred to a solution of 2% nonfat dry milk in 1x Tris-buffered saline (TBS)-T (0.05% final concentration Tween-20) where they incubated on an orbital shaker for one to three hours at room temperature. Blots were then incubated in rabbit antiplant γ -H2AX primary antibody [10] diluted in 2% nonfat milk in 1x TBS-T on a rocking platform for 2h at room temperature. Blots were rinsed twice in ddH₂O and once in 1x TBS-T (five minutes each time) on an orbital shaker, before transfer to a solution of anti-rabbit immunoglobulin horseradish peroxidase-linked secondary antibody (Amersham Biosciences NA934V, Piscataway, NJ) diluted 1:10,000 in 2% nonfat milk in 1x TBS-T. Blots were incubated in secondary antibody on an orbital shaker at room temperature for 1-1.5h, at which point they were rinsed with ddH₂O and 1x TBS-T as above. Blots were then treated with enhanced chemiluminescence reagents (ECL Plus) as described (RPN 2131, Amersham Biosciences) and exposed to X-ray film (CL-XPosure film, Pierce, Rockland, IL).

Quantification of Relative γ -H2AX Content

To estimate γ -H2AX content in our mutant lines relative to wild-type, fresh protein extractions were made from plants irradiated with a dose of 200Gy as described above. 15.0 ng of extracted protein from *ath2axa*, *ath2axb*, and *ath2axa;ath2axb* were loaded on a polyacrylamide gel. A dilution series of WT protein extract was also loaded on the gel (2x, 1x, 0.25x, and 0.0625x where 1x=15ng). Separation, transfer, and immunoblotting of γ -H2AX was carried out as described above. To increase the sensitivity of the x-ray film and to increase the linear range of detection, film was pre-exposed using an automatic flash (Sunpak Softlite 1600A, ToCAD, Rockaway, NJ) masked with porous paper. An optimal exposure distance of 50cm was empirically determined such that a pre-exposure flash increased the 540 nm absorbance of pre-exposed film by 0.15 with respect to film that had not been pre-exposed [23, 24]. Pre-exposed film was immediately used to detect chemiluminescent signal from the immunoblots. Developed images were digitally scanned (Epson Perfection 2400 Photo, Epson, Long Beach, CA), and analyzed using 'ImageQuant™ v5.2' (GE Healthcare, Piscataway, NJ). Total signal for each band was calculated as the integrated intensity of all pixels within a user defined box that encompassed that band. A local average correction for each band was used to exclude background signal. The adjusted signal for the wild-type dilution series was used to generate a standard curve of signal intensity vs. relative γ -H2AX content in 15 ng of protein extract. This curve was used to estimate the γ -H2AX content of our mutant lines relative to wild-type.

Root Tip Excision, Slide Preparation, and Immunostaining

Root tips were excised and mounted as described [25] with the modifications reported [10]. Slides were stored at -80°C until they were ready to be stained and scored. Root tip nuclei were stained to visualize γ -H2AX, tubulin, and chromosomal DNA as described [10]. After an overnight incubation at 4°C, nuclei were visualized, scored, and images captured [10].

Root Growth Assay

Seeds used in root growth assays were prepared and irradiated or mock-irradiated as described above. An image of each plate was captured immediately after irradiation, 0 days after treatment (DAT), using a CoolSNAP CCD camera (Photometrics, Tucson, AZ) affixed to a Zeiss Stemi SV 11 stereomicroscope (Zeiss, Thornwood, NY); plates were then returned to the growth chamber. A second image of each plate was captured 7 DAT. Root lengths were determined by tracing the primary root using the image processing and analysis software 'ImageJ' [26]. To reduce error introduced by seeds that did not germinate, seeds that germinated late, and seedlings whose roots did not achieve or maintain good contact with the vertical agar surface, only those plants whose primary root length was in at least the plate's 66th percentile 0 DAT were included in the data set. Root length 0 DAT was subtracted from root length 7 DAT to obtain post-treatment root growth (PTRG). PTRG of irradiated plants was normalized to PTRG of mock-treated lines.

Results

Isolation of *ath2AXa* and *ath2AXb* insertion mutants

The publicly available seed stocks of the Arabidopsis Biological Resource Center (ABRC) were screened to identify possible insertional mutants in *ath2AXa* and *ath2AXb*. Annotated sequence information from the Salk Institute Genomic Analysis Laboratory (SAIL) identified two potentially valuable lines: ABRC line 'SALK_007006.29.20.x', whose transferred DNA (T-DNA) mapped somewhere near the first exon of *ath2AXa*, and ABRC line 'SALK_012255.55.25.x', whose T-DNA mapped to the middle of *ath2AXb*. Polymerase chain reaction (PCR) primers were designed according to the DNA sequences found in the SAIL database and used to verify the presence of the T-DNA in each line. The insertion site of each line was characterized by sequencing off of the T-DNA border sequence. Sequencing of the insertion site of 'SALK_007006.29.20.x' (*ath2axa*) indicated that the T-DNA is located 68 bp upstream of the start codon of *ath2AXa*. The insertion is accompanied by a deletion of 8 bp and, based on PCR and sequencing data, has two left borders pointing away from the insertion site into the genomic DNA (Fig. 1a). Characterization of the insertion site of 'SALK_012255.55.25.x' (*ath2axb*) proved to be more difficult as we were only able to obtain PCR and sequencing data from one border of the T-DNA insert. Sequencing off the left border indicated that the T-DNA is located in *ath2AXb*'s only intron, 84 bp upstream of the second exon (Fig. 1b). While we were unable to obtain PCR products or sequencing information from the other border using both left and right border sequence information, genomic primers spanning *ath2AXb*'s coding sequence gave no product in lines homozygous for the T-DNA insert; those same primer combinations give clear bands in heterozygous *ath2AXb* and wild-type lines, suggesting that the T-DNA insert truly does disrupt the wild-type copy of *ath2AXb* rather than simply duplicating a portion of the gene and reinserting elsewhere in the genome, leaving a wild-type copy of the gene intact.



Figure 1 Gene structure and T-DNA insertion site of mutant lines *ath2axa* (a) and *ath2axb* (b). Shaded line, UTR; black line, intron; black box, exon; gap, 8 bp deletion; triangle, T-DNA; LB, T-DNA left border; regular text, genomic DNA sequence; underlined text, T-DNA border sequence; parenthetical text, DNA sequence that matches neither T-DNA border sequence nor genomic DNA exactly; ellipsis, continuation of adjacent DNA sequence; question mark, unresolved T-DNA border and insertion site.

After confirming the locations of the T-DNAs, lines *ath2axa* and *ath2axb* were crossed and their F₂ progeny screened to identify homozygous lines. Using a T-DNA left border specific primer and flanking gene specific primers we were able to isolate homozygous double mutant *ath2axa;ath2axb* lines as well as recover homozygous single mutant lines for both *ath2axa* and *ath2axb*. Wild-type segregants were also identified and maintained for use as controls in subsequent experiments. The mutant lines isolated were both viable and fertile. No morphological difference was apparent in either single mutant or double mutant plants. Genetic crosses using *ath2axa*, *ath2axb*, or *ath2axa;ath2axb* were successful in all cases, regardless of whether the mutant line functioned as the maternal source (ovule), the paternal source (pollen), or both (self-cross).

Production of γ -H2AX is repressed in H2AX mutants.

To test if *ath2axa* and *ath2axb* are still capable of producing functional H2AX protein, histones from homozygous lines were extracted before and after exposure to IR and probed with polyclonal *Arabidopsis* γ -H2AX antibodies [10]. In extracts from wild-type plants taken 15 minutes after exposure to 200Gy gamma radiation, a clear band of ~16 kDa is observed, reflecting the presence of IR induced γ -H2AX protein; comparable bands are detected in extracts from IR treated single mutant *ath2axa* and *ath2axb* plants. In extracts from IR treated double mutant *ath2axa;ath2axb* plants, the ~16kDa band is faint, though discernable, suggesting that at least one of the mutant lines is not a complete loss of function mutation (Fig. 2a). Control experiments, in which extract from IR treated double mutant *ath2axa;ath2axb* plants was run separately from other positive lanes, indicate that faint γ -H2AX signal detected is not the result of spillover from adjacent lanes. By comparing the signal intensity of the γ -H2AX band observed in the single and double mutant H2AX lines to that of a wild-type dilution series (Fig. 2b), we estimate an approximate ten-fold reduction in γ -H2AX content for *ath2axa;ath2axb* plants relative to wild-type plants (Fig. 2c).

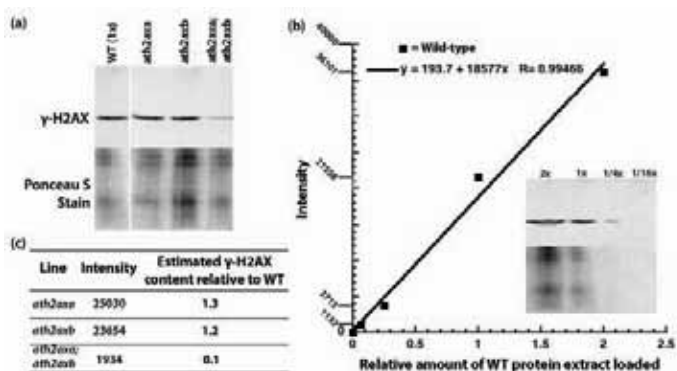

Figure 2 Quantification of γ -H2AX in wild-type and mutant lines. Plants were irradiated with 200Gy gamma radiation and harvested 15 minutes after removal from source. Ponceau S staining was carried out prior to immunoblotting as a qualitative control for protein loading and uniformity of transfer. (a) Assessment of γ -H2AX induction in response to IR in wild-type and mutant lines by immunoblot. Image is representative of blots from four experiments. (b) Linear regression of immunoblot γ -H2AX band intensity, corrected for local average background signal, as a function of relative amount of wild-type (WT) protein extract loaded. The amount of sample loaded ranged from 2x to 1/16x (inset), where 1x is equivalent to 15 ng of protein extract. (c) Estimate of γ -H2AX content in mutant lines relative to wild-type as determined from (b).

Neither single mutant exhibited decreased levels of γ -H2AX content relative to wild-type. A faint ~16 kDa band is also observed in extracts from untreated wild-type, untreated *ath2axa*, and untreated *ath2axb* plants; this band is not detected in untreated *ath2axa;ath2axb* plants

(data not shown). Presence of this band in extracts from untreated wild-type plants has been previously reported and may reflect some low, steady state level of phosphorylation in cells, or may be due to low level detection of unphosphorylated H2AX by the polyclonal antibodies [10].

H2AXa and H2AXb act redundantly in the formation of IR induced γ -H2AX

While it is clear from our immunoblot experiments that both H2AXa and H2AXb are phosphorylated in response to IR, it was unclear whether the two proteins function redundantly in the formation of the γ -H2AX foci characteristic of DSB response. To address this question, γ -H2AX foci were quantified in *ath2axa*, *ath2axb*, and *ath2axa;ath2axb* root tips exposed to IR. Only a slight difference in the number of foci produced per Gy gigabasepair (Gy*Gbp) was observed in either single mutant (Fig. 3). This suggests that H2AXa and H2AXb function redundantly in the establishment of IR induced foci. Consistent with this hypothesis is the fact that we were unable to detect production of γ -H2AX foci in our *ath2axa;ath2axb* double mutant plants. Of the 74 mitotic root tip cells scored, no γ -H2AX foci were observed, suggesting that a wild-type copy of either of these two homologues is essential for the formation of γ -H2AX foci. While our immunoblot results indicate the presence of some γ -H2AX in our IR treated *ath2axa;ath2axb* double mutant line, any contribution it may make to the formation of foci is below our level of detection.

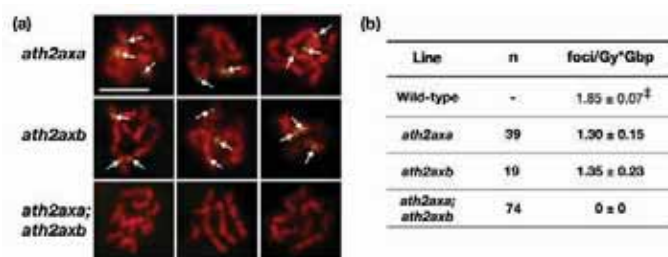

Figure 3 γ -H2AX foci formation in *ath2AX* mutant lines. (a) Immunofluorescence of mutant root tip nuclei irradiated with 5Gy gamma radiation. γ -H2AX foci (green) are overlaid onto chromosomes (red) stained with DAPI. Arrows highlight positions of γ -H2AX foci. Scale bar, 5 μ m. (b) Number of γ -H2AX foci generated per Gy per gigabasepair (Gbp) \pm standard error. Root tip nuclei were irradiated with either 5Gy or 2.5Gy gamma radiation. n, number of root tip nuclei scored. [‡], rate of foci induction in wild-type root tip nuclei exposed to 5Gy or 2.5Gy gamma was calculated from previous experimental data (Friesner, 2005).

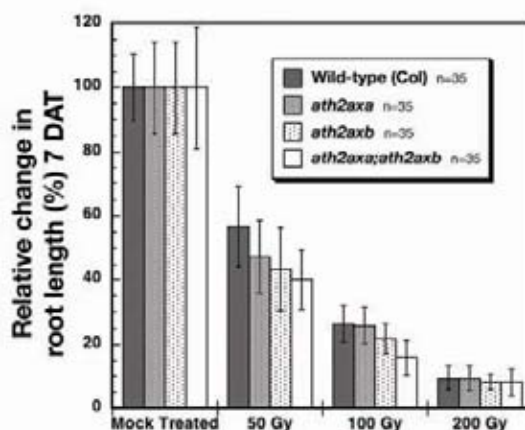

Figure 4 Root growth of IR treated lines in the first seven days after gamma treatment (7 DAT). Values expressed as percent change in root length relative to percent change in root length of mock treated plants. Error bars, standard error; n, number of plants scored.

A subtle change in root growth following exposure to gamma radiation is observed in H2AX mutants.

We sought to further investigate the importance of H2AXa and H2AXb in response to gamma radiation by assaying root growth in each of our mutant lines. Monitoring root growth, a product of both cell division and cell expansion, is a simple means of quantifying the impact of DNA damaging agents on a plant. In the days immediately following exposure to gamma radiation, the wild-type line, both single mutant H2AX lines, and the double mutant line all displayed decreases in overall root growth correlated to the dose of IR they received (Fig. 4).

Our single mutant lines *ath2axa* and *ath2axb* both displayed a slightly greater inhibition of root growth than wild-type, though the difference was not statistically significant. In our IR treated double mutant seedlings, an even greater inhibition of root growth was observed, though the difference relative to wild-type was still not statistically significant. This trend is observed across a range of IR doses, though it is most obvious at a dose of 100Gy. While the effect of gamma radiation on root growth is not significantly different between wild-type and mutant lines, the overall trend suggests that the two *Arabidopsis* H2AX homologues play redundant roles in the plant's response to DSBs.

Discussion

H2AXa and H2AXb may act redundantly in the response of *Arabidopsis thaliana* to ionizing radiation.

In this article we report the identification and isolation of a pair of T-DNA insertional mutants affecting the expression of two H2AX homologues, *atH2AXa* and *atH2AXb*, encoded by the model plant *Arabidopsis thaliana*. Although we were unable to obtain a line in which H2AX production is completely abolished, we demonstrate a roughly ten-fold reduction in the amount of γ -H2AX produced in response to gamma radiation in our double mutant line. Given that untreated *atH2AXa*, *atH2AXb*, and *atH2AXa;atH2AXb* plants exhibit no obvious changes in either their overall morphology or their growth habits, it is clear that wild-type levels of H2AX are not essential for viability in *A.thaliana*. While it is possible that a full loss of function line would be inviable, our results are consistent with the observation that H2AX-deficient mouse embryonic stem cells are also viable [27]. Unlike H2AX-deficient mice, however, which display a significant reduction in fertility [28], no defect in fertility was observed in *atH2AXa;atH2AXb* plants; this may indicate that very low levels of H2AX are sufficient to carry out meiotic processes during gametogenesis. Alternatively, H2AX may be wholly unnecessary in *A. thaliana* for normal meiotic recombination and fertility.

While H2AX may not be essential for cell viability, it does play an important role in resistance to DSB inducing agents [13, 27]. The role of γ -H2AX in IR resistance in plants has not yet been determined. We demonstrate that *atH2AXa* and *atH2AXb* function redundantly in IR induced γ -H2AX foci formation, an early and rapid step in a cell's response to DSBs. We report a slight decrease in root growth following exposure to IR in our double mutant line relative to wild-type, suggesting *atH2AXa* and *atH2AXb* may play a role in mitigating the effects of damage caused by IR. Whether the minor decrease in root growth we observe is due to the persistence of unresolved damage, reflects a defect in the ability of cells to resume normal cycling, or is a result of some other defect is unknown. It is clear from our results that *atH2AXa* and *atH2AXb* act redundantly in the overall production of γ -H2AX in irradiated seedlings and in focus formation in irradiated root tips of *A.thaliana*; however, this does not preclude the possibility that divergent functions may also exist that distinguish the two homologues. The precise role H2AX plays in DNA damage response and cell cycling, and more specifically, the roles *atH2AXa* and *atH2AXb* play in *A.thaliana*, remain open and warrant further investigation.

ACKNOWLEDGEMENTS

We thank Dr. Bo Liu and Dr. Ken Kaplan for their kind assistance and the Salk Institute for the sequence-indexed T-DNA insertion mutants. This work was funded by an NIH training grant (# T32 GM070377), an Elsie Stocking Memorial Fellowship, and from the National Research Initiative of the USDA Cooperative State Research, Education and Extension Service (#04-35301-14740).

BIBLIOGRAPHY

- Ragu, S. *et al.* Oxygen metabolism and reactive oxygen species cause chromosomal rearrangements and cell death. *Proc. Natl. Acad. Sci. Usa* **104**(23), 9747-9752 (2007).
- Barnes, D.E. DNA damage: Air-Breaks? *Curr. Biol.* **12**(7), R262-264 (2002).
- Sutherland, B.M., Bennett, P.V., Sidorkina, O., Laval, J. Clustered DNA damages induced in isolated DNA and in human cells by low doses of ionizing radiation. *Proc. Natl. Acad. Sci. Usa* **97**(1), 103-108 (2000).
- Regulus, P., *et al.* Oxidation of the sugar moiety of DNA by ionizing radiation or bleomycin could induce the formation of a cluster DNA lesion. *Proc. Natl. Acad. Sci. Usa* **104**(35), 14032-14037 (2007).
- Degrassi, F., Fiore, M., Palitti, F. Chromosomal aberrations and genomic instability induced by topoisomerase-targeted antitumour drugs. *Curr. Med. Chem. Anti Canc. Agents* **4**(4), 317-325 (2004).
- Povirk, L.F. DNA damage and mutagenesis by radiomimetic DNA-cleaving agents: bleomycin, neocarzinostatin and other enediynes. *Mutat. Res.* **355**(1-2), 71-89 (1996).
- Keeney, S., Neale, M.J. Initiation of meiotic recombination by formation of DNA double-strand breaks: mechanism and regulation. *Biochem. Soc. Trans.* **34**(Pt 4), 523-525 (2006).
- Melo, J., Toczyski, D. A. A unified view of the DNA-damage checkpoint. *Curr. Opin. Cell Biol.* **14**(2), 237-245 (2002).
- Bleuyard, J.Y., Gallego, M.E., White, C.I. Recent advances in understanding of the DNA double-strand break repair machinery of plants. *DNA Repair (Amst.)* **5**(1), 1-12 (2006).
- Friesner, J.D., Liu, B., Culligan, K., Britt, A.B. Ionizing radiation-dependent gamma-H2AX focus formation requires ataxia telangiectasia mutated and ataxia telangiectasia mutated and Rad3-related. *Mol. Biol. Cell.* **16**(5), 2566-2576 (2005).
- Burma, S., Chen, B.P., Murphy, M., Kurimasa, A., Chen, D.J. ATM phosphorylates histone H2AX in response to DNA double-strand breaks. *J. Biol. Chem.* **276**(45), 42462-42467 (2001).
- Ward, I.M., Chen, J. Histone H2AX is phosphorylated in an ATR-dependent manner in response to replicational stress. *J. Biol. Chem.* **276**(51), 47759-47762 (2001).
- Downs, J.A., Lowndes, N.F., Jackson, S.P. A role for *Saccharomyces cerevisiae* histone H2A in DNA repair. *Nature* **408**(6815), 1001-1004 (2000).
- Celeste, A. *et al.* Histone H2AX phosphorylation is dispensable for the initial recognition of DNA breaks. *Nat. Cell. Biol.* **5**(7), 675-679 (2003).
- Chen, X. Arciero, C.A., Wang, C., Broccoli, D., Godwin, A.K. BRCC36 is essential for ionizing radiation-induced BRCA1 phosphorylation and nuclear foci formation. *Cancer Res.* **66**(10), 5039-5046 (2006).
- Paull, T.T. *et al.* A critical role for histone H2AX in recruitment of repair factors to nuclear foci after DNA damage. *Curr. Biol.* **10**(15), 886-895 (2000).
- Rogakou, E.P., Pilch, D.R., Orr, A.H., Ivanova, V.S., Bonner, W.M. DNA double-stranded breaks induce histone H2AX phosphorylation on serine 139. *J. Biol. Chem.* **273**(10), 5858-5868 (1998).
- Fillingham, J., Keogh, M.C., Krogan, N.J. GammaH2AX and its role in DNA double-strand break repair. *Biochem. Cell Biol.* **84**(4), 568-577 (2006).
- Downey, M., Durocher, D. GammaH2AX as a checkpoint maintenance signal. *Cell Cycle* **5**(13), 1376-1381 (2006).
- Nakada, S., Chen, G.I., Gingras, A.C., Durocher, D. PP4 is a gammaH2AX phosphatase required for recovery from the DNA damage checkpoint. *Embo Rep.* (2008).
- Redon, C. *et al.* Histone H2A variants H2AX and H2AZ. *Curr. Opin. Genet. Dev.* **12**(2), 162-169 (2002).
- Jackson, J.P. *et al.* Dimethylation of histone H3 lysine 9 is a critical mark for DNA methylation and gene silencing in *Arabidopsis thaliana*. *Chromosoma* **112**(6), 308-315 (2004).
- Laskey, R.A., Mills, A.D. Quantitative film detection of 3H and 14C in polyacrylamide gels by fluorography. *Eur. J. Biochem.* **56**(2), 335-341 (1975).

24. Voytas, D., Ke, N. Detection and quantitation of radiolabeled proteins in gels and blots. *Curr. Protoc. Cell. Biol.* **Chapter 6**, Unit 6.3 (2001).
25. Liu, B., Marc, J., Joshi, H.C., Palevitz, B.A. A gamma-tubulin-related protein associated with the microtubule arrays of higher plants in a cell cycle-dependent manner. *J. Cell. Sci.* **104** (Pt 4), 1217-1228 (1993).
26. Abramoff, M.D., Magelhaes, P.J., Ram, S.J. Image Procession with ImageJ. *Biophotonics Int.* **11**(7), 36-42 (2004).
27. Bassing, C.H. *et al.* Increased ionizing radiation sensitivity and genomic instability in the absence of histone H2AX. *Proc. Natl. Acad. Sci. Usa* **99**(12), 8173-8178 (2002).
28. Celeste, A. *et al.* Genomic instability in mice lacking histone H2AX. *Science* **296**(5569), 922-927 (2002).

Role of Human Disease Genes for the Maintenance of Genome Stability in Plants

H Puchta*, D Kobbe, K Wanieck, A Knoll, S Suer, M Focke & F Hartung

Abstract

In the plant genome a row of homologs of human genes can be found that, if mutated, are correlated with a high incidence of cancer in humans. Here we describe our recent results on homologs of the breast cancer genes BRCA1/BARD1 and RecQ helicase homologs in the model plant *Arabidopsis thaliana*. HsBRCA1 and HsBARD1 are tumor suppressor proteins that are involved in many cellular processes, such as DNA repair. Loss of one or the other protein results in early embryonic lethality and chromosomal instability. The Arabidopsis genome harbors one BRCA1 homolog, and we were able to identify a BARD1 homolog as well. AtBRCA1 and AtBARD1 are able to interact with each other as indicated by *in vitro* and *in planta* experiments. Our analyses of T-DNA insertion mutants for both genes, revealed that in plants, in contrast to animals, these genes are dispensable for development or meiosis. Nevertheless, we could show that AtBARD1 plays a prominent role in the regulation of homologous DNA repair in somatic cells. RecQ helicases are known as mediators of genome stability. The loss of RecQ function is often accompanied by hyperrecombination due to a lack of crossover suppression. *Arabidopsis thaliana* possesses seven different RecQ genes. We could show that two of them (*AtRECQ4A* and *AtRECQ4B*) arose as a result of a recent duplication and are still 70% identical on protein level. Disruption of these genes, surprisingly, leads to antagonistic phenotypes: the *AtRECQ4A* mutant shows sensitivity to DNA damaging agents, enhanced homologous recombination and lethality in an *Atmus81* background. Moreover, mutation of *AtRECQ4A* partially suppresses the lethal phenotype of an *AtTOP3a* mutant. In contrast, the *AtRECQ4B* mutant shows a reduced level of HR and none of the other phenotypes described above. Finally, we have started to characterize the different RecQ proteins of Arabidopsis by biochemical means and present here the results on AtRECQ2.

Breast Cancer Genes: BRCA1, BRCA2 and BARD1

Genome stability is a crucial aspect of any living organism. It is essential to cope with DNA damages and to repair them properly. Many human diseases, especially cancer, are linked to different kinds of defects in DNA repair mechanisms which might lead to chromosome abnormalities or uncontrolled proliferation. Defects in DNA repair or recombination genes often predispose humans to cancer development, as it is seen for instance in patients of Bloom and Werner syndrome or breast cancer. Those diseases are linked to mutations in genes whose encoded proteins function as DNA repair proteins. Usually, cancer is not due to a single mutation, but a certain mutation might lead to a higher susceptibility for developing cancer. As breast cancer is the most prevalent cancer worldwide many studies have been made to identify and to understand the role of certain breast cancer factors. In 1994, the first gene which seemed to be genetically linked to the development of hereditary breast cancer was identified [1]. This gene was called *Breast Cancer Susceptibility Gene 1*

(BRCA1). Besides BRCA1, another breast cancer gene was identified the following year and named BRCA2 [2]. Later on, it could be shown that both proteins are important factors for homologous recombination (HR) during DNA repair.

As proteins are often part of different complexes and their function depends on certain interactions, there are several known proteins, which are important for the function of BRCA1. The most prominent interaction partner of BRCA1 is the *Breast Cancer Associated Ring Domain Protein* BARD1. The name implies its interaction with BRCA1 via their RING domains. **Figure 1A** shows the general structure of the human breast cancer proteins. Homologs of these genes were identified in several other organisms as well, and interestingly also in the model plant *A. thaliana* [3-5].

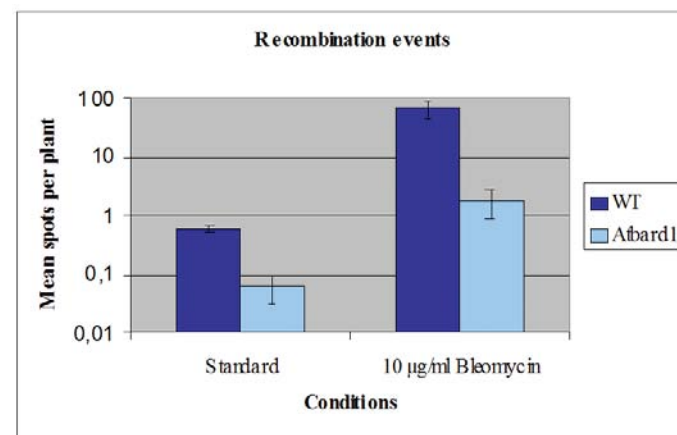
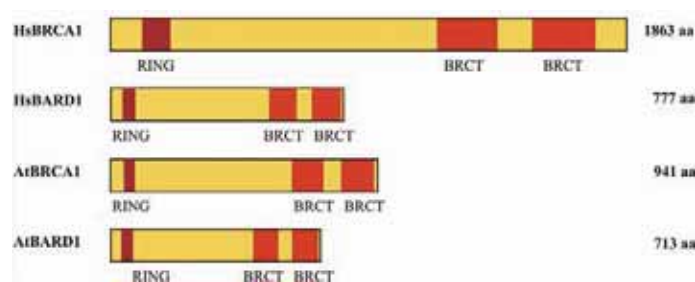

Figure 1 Structure of human and plant breast cancer proteins and the AtBARD1 function during HR. **(A)** The characteristic features of breast cancer proteins are the N-terminal RING and the C-terminal BRCT domains. Both domains are important for protein-protein interactions and the proper functions of the proteins. RING = Really Interesting New Gene; BRCT = BRCA1 C-terminal; Hs = Homo sapiens; At = Arabidopsis thaliana. **(B)** The *Atbard1* mutant plants show a reduction of HR under standard conditions in comparison to the wild type (WT). After induction of double stranded breaks with Bleomycin, the wild type shows a clear induction of HR. The HR in *Atbard1* mutant plants after induction with Bleomycin is less induced, indicating a role for *AtBARD1* in HR. The diagram shows the mean number of blue spots per plant (bars show the SD) from three different experiments with a logarithmic scale for a better presentation.

University of Karlsruhe, Department of Botany II, Karlsruhe, Germany

* Corresponding author. E-mail: holger.puchta@bio.uka.de

Structure of plant homologs

As mentioned above, in *A. thaliana* and other plants, gene homologs of BRCA1, BRCA2 and BARD1 were identified. *AtBRCA1* and *AtBARD1* are single copy genes, whereas *AtBRCA2* is a duplicated gene. The homology between the breast cancer genes and their plant orthologs is mainly conserved in the region of their functional domains. Both BRCA1 and BARD1 possess an N-terminal RING and two C-terminal BRCT-domains. The RING domain of *AtBRCA1* has 34% identity and 61% similarity to the human ortholog, whereas the homology of the BRCT region has 28% identity and 61% similarity [4]. The alignment of *AtBARD1* with HsBARD1 shows 22% identity and 38% similarity [5]. The RING domain is a protein interaction domain, which is necessary for the E3-Ubiquitin Ligase function of BRCA1 and BARD1 alone as well as for the respective heterodimer. The function of the BRCT domains is based on interactions with phosphopeptides and might therefore be important for regulatory processes. Both BRCA1/BARD1 and BRCA2 play essential roles during mitotic and/or meiotic DNA repair and recombination events. Their essential role in mammals is shown in early embryonic lethality of homozygous BRCA1, BARD1 and BRCA2 mutant mice [6-8]. Interestingly, in *A. thaliana* homozygous single mutant plants of the breast cancer genes are, in contrast to their mammalian counterparts, not lethal. This offers a unique system for studying putative, conserved functions of these breast cancer genes in a higher eukaryotic organism.

Functional Analysis in Plants

BRCA1 and BARD1 are important factors of homologous recombination in somatic cells. Studies in different organisms led to the conclusion that this function seems to be conserved. Via a recombination assay system for *A. thaliana*, it was shown that the *Atbard1* single mutants display a defect in homologous recombination and that they are sensitive to MMC, which leads to DNA cross links [5]. **Figure 1B** shows the clear reduction of HR in *Atbard1* mutant plants under standard as well as under genotoxic conditions indicating a role for *AtBARD1* in HR. *AtBRCA2* is also important for HR and plays an essential role during meiosis [3]. As the genome of *A. thaliana* harbors two almost identical homologs, those proteins might have a redundant function.

Research on the function of breast cancer genes in plants might give insight into conserved functions of those genes, as well as reveal plant specific functions. Our present studies concentrate on other proteins that interact with breast cancer proteins. One such family is the RecQ family, whose proteins are also linked to several human diseases.

RecQ helicases as genomic caretakers

Out of the five human homologs of *E. coli* RecQ, mutations in three of them have been shown to result in severe autosomal recessive hereditary diseases. Bloom Syndrome (BS), Werner Syndrome (WS) and Rothmund-Thomson Syndrome (RTS) result from biallelic loss-of-function mutations in the genes BLM, WRN or HsRECQ4, respectively. Patients diagnosed with the disorders RAPADILINO Syndrome and Baller-Gerold Syndrome (BGS) have recently been shown to carry mutations in the HsRECQ4 gene as well.

All of these syndromes result in a set of common characteristics, for example genomic instability and a predisposition to cancer malignancies [9]. However, there are also syndrome-specific features and unique cellular and genetic defects that suggest non-redundant cellular functions for these RecQ helicases. BS patients present with a proportional growth deficiency, skin abnormalities, such as sun sensitivity, hypo- and hyperpigmentation, fertility defects and changes in fat and sugar metabolism [10]. Notably, there is an increased predisposition to all types of cancer with high incidence. In BS fibroblasts, the hallmark characteristic is the elevated rate of sister chromatid exchanges due to increased homologous recombination.

Shortly after the connection of BLM with BS, it was shown that mutations in the WRN gene are causative for the recessive disorder Werner Syndrome [11,12]. WS is a progeroid disease resulting in premature aging that develops during the second decade of life and is associated with age-related disorders like greying and loss of hair, skin atrophy, atherosclerosis, osteoporosis, bilateral cataracts and type II diabetes mellitus. WS is also associated with a high incidence of cancer, but contrary to BS patients, individuals with WS show a predisposition primarily to sarcomas. On the cellular level, WS manifests in genomic instability due to chromosome breaks, reciprocal chromosomal translocations and genomic deletions.

The third and only other human RecQ helicase that has been associated with a disease is HsRECQ4, mutated in about 60% of all persons diagnosed with Rothmund-Thomson Syndrome [13]. RTS manifests in skeletal abnormalities, poikiloderma (skin atrophy and dyspigmentation), cataracts, hypogonadism, early greying and loss of hair. The cancer predisposition typical for RecQ-related disorders is seen in RTS as well, but it is restricted mainly to osteosarcomas.

RecQ helicases in plants

In total, there are seven different RecQ like genes present in the model plant *A. thaliana* (**Fig. 2**). As mentioned before, mutations in the human gene coding for the BLM protein lead to a severe genetic disorder called Bloom syndrome [12]. On the sequence level, two of them, *AtRECQ4A* and *AtRECQ4B*, can be considered putative HsBLM homologs. Regarding the conserved domains within the seven helicase motifs, both proteins share a sequence identity of approximately 53% with the HsBLM protein, and incidentally about 46% with the yeast RecQ homolog SGS1.



Figure 2 Human and Arabidopsis RecQ homologs. The typical structure of RecQ helicases is found in virtually all members of this family. The RecQ helicase domain, the RecQ-Ct- and the HRDC domain (Helicase and RNase D C-terminal) are most common, whereas the exonuclease domain is only found in the WRN protein, and the EF-hand motif only in *AtRECQ4A*. In plants and insects, the exonuclease domain of the HsWRN protein is coded by a small gene, which seems to be fused in HsWRN.

AtRECQ4A and *AtRECQ4B* exhibit an identity of about 70% regarding their DNA and protein sequences, and have therefore arisen from a recent duplication event [14]. Amazingly, in contrast to their high sequence similarity, mutations in *AtRECQ4A* and *4B* lead to oppositional phenotypes respectively. Whereas *Atrecq4A* reflects the “RecQ typical” phenotype showing sensitivity towards genotoxic agents, such as MMS or cisplatin, *Atrecq4B* plants are not more affected than the wild type control plants [15,16]. Furthermore, we could show hyperrecombination for *Atrecq4A*, as it has been shown for other RecQ mutants, such as human *blm* or yeast *sgs1* [15-18]. In contrast to the expected results obtained for *Atrecq4A* as typical RecQ mutant, in *Atrecq4B* plants somatic HR is strongly reduced compared to the wild type [15]. This hyporecombination phenotype has not been described for any eukaryotic RecQ mutant so far, and points to a positive involvement of the *AtRECQ4B* protein in the recombination process.

Another property that seems to be conserved in *AtRECQ4A* is the interaction with a type IA topoisomerase. This interaction has directly been shown for yeast SGS1 with TOP3, as well as for the human BLM

protein with HsTOP3 α [19]. Due to the severity of the phenotypes, it is problematic to study eukaryotic TOP3 α functions with the help of the respective mutants. Nevertheless, we could show very recently for *Atrecq4A* that this mutation is able to rescue the lethal phenotype of *top3a* mutants in *Arabidopsis*, resulting in sterile but viable plants [15].

Finally, double mutants of *Atmus81* and *Atrecq4A* develop poorly and die within about two weeks. This is in line with the lethality found in double mutants of the structure-specific endonuclease MUS81 and the respective RecQ homologs of budding and fission yeast, SGS1 and RQH1, which are synthetically lethal. This result points to a high level of conservation of the somatic RECQ and MUS81 functions, such as the involvement of both proteins in two parallel pathways working on stalled replication forks [16].

In both cases, the results obtained for the RecQ double mutants with *mus81* or *top3a*, respectively, are restricted to the *recq4A* mutation of *A. thaliana*, whereas for *Atrecq4B* no effect on the *Attop3a* and *Atmus81* phenotypes could be observed [15,16]. Therefore it can be concluded that in *Arabidopsis* RECQ4A, and not RECQ4B, is in most aspects the functional homolog of BLM and SGS1. Nevertheless, the recombination promoting function of RECQ4B might also have originated from a common BLM-like ancestor protein.

Biochemical characterization of AtRECQ2

Whereas the T-DNA insertion mutants enable us to analyze the effect of missing or truncated proteins, biochemical analysis reveals what reactions the proteins are possibly able to catalyze. The two approaches are complementary, with the biochemical analysis a reaction is being tested for feasibility, for example, if a participation in a specific pathway is proposed. However, biochemical analysis does not state whether a specific reaction is really taking place *in vivo*, since it may be influenced, for instance, by post-translational modifications of the protein or by protein interaction partners. On the other hand, with the help of specific information on the types of substrates the enzyme might process, a more focused *in vivo* analysis can be performed.

The method used is briefly introduced here: DNA sequences are designed with complementary and non-complementary stretches in such a way that a specific DNA-structure will form. The DNA structure is built by heating one labeled oligonucleotide (^{32}P) together with the other constituents and cooling them down slowly with subsequent purification. It is incubated with the enzyme under defined conditions. Then, the reaction products are analyzed via native polyacrylamide gel electrophoresis (PAGE), in which the original structure is separated from the product(s). The structures containing a ^{32}P label can be analyzed and quantified allowing the calculation of the percentage of unwinding.

Here, some data of our biochemical characterization of *A. thaliana* RECQ2 is presented [20]. AtRECQ2, together with AtRECQ4A and AtRECQ4B, possess the complete set of (uninterrupted) domains, characteristic for RecQ-helicases, as do HsWRN and HsBLM (Fig. 2). Additionally, AtRECQ2 interacts with AtWRNexo [21]. AtWRNexo is homologous to the exonuclease domain of HsWRN (Fig. 2) and biochemical analysis of AtWRNexo has revealed conserved properties [22]. We analyzed the biochemical functions of AtRECQ2 in order to classify it either as orthologous to the HsWRN-helicase or as a potentially plant-specific protein with its own set of functions.

We expressed AtRECQ2 in *E. coli* and successfully purified it with the help of an N-terminal calmodulin binding peptide tag and a C-terminal hexahistidine tag. In order to be able to judge the purity of our AtRECQ2 preparation, we also cloned, expressed and purified AtRECQ2-K117M in an identical fashion. For AtRECQ2-K117M, the substitution of lysine by methionine in the Walker A motif leads to an abolishment of ATPase and therefore helicase activity. Thus, an activity observed in assays with AtRECQ2 that is missing with AtRECQ2-K117M is due to our enzyme of interest.

We were able to show that AtRECQ2 is a (d)NTP dependent 3' to 5' DNA helicase (Fig. 3A and B). This can not be taken for granted as for example, no helicase activity was shown for HsRECQ4 [23]. The ability of AtRECQ2 to use all nucleotide cofactors to catalyze unwinding is not common for RecQ helicases. These properties are only similar to those of HsWRN helicase, for which ATP and dATP are best as well, followed by dCTP and CTP. Strand unwinding by HsWRN can also be measured with GTP, dGTP, UTP and dTTP but it is not efficient [24]. All other RecQ-homologs analyzed for the usage of different (d)NTPs are more restricted.

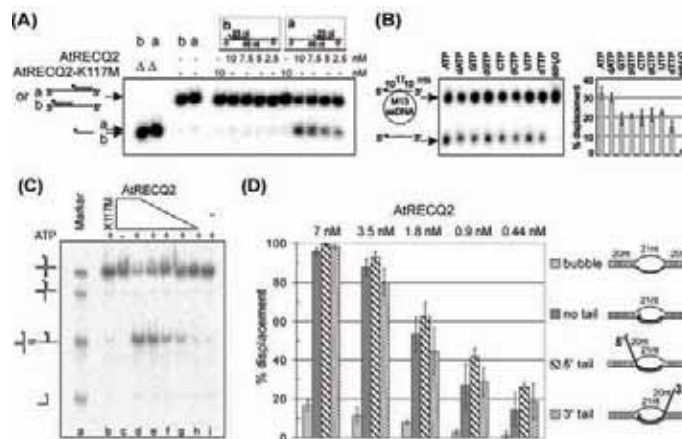

Figure 3 Biochemical analysis of AtRECQ2 [20]. **(A)** AtRECQ2 is a 3'-5' DNA helicase. The substrates are schematically drawn in the dotted boxes; * marks the ^{32}P -label. The arrows indicate the positions of migration of the substrates (top) or the 23 nt - unwinding products of substrate a (unwound by 3' 5' helicases) and b (unwound by 5' 3' helicases), respectively (bottom). The reactions with AtRECQ2-K117M show no unwinding, thus the AtRECQ2 preparation is devoid of helicase contamination. μ heat-denatured substrate. **(B)** AtRECQ2 can use different nucleotide-triphosphates for unwinding. Helicase data are presented as autoradiogram and as mean with SD. For the respective reactions ATP was substituted by dATP, GTP, dGTP, CTP, dCTP, UTP, dTTP and water. **(C)** AtRECQ2 can branch migrate Holliday Junctions. Autoradiography of the reaction products. In reaction c ATP was omitted. It is clearly visible that the main product of AtRECQ2 is splayed arm, indicative for branch migration. **(D)** Quantification of helicase data (mean and SD) of reactions with a bubble and different D-Loop-structures, schematically drawn on the right. The invading strands of the D-Loop structures were unwound. No significant preference for a special D-Loop structure can be observed with different AtRECQ2 concentrations used.

The reaction of AtRECQ2 was also analyzed on DNA substrates that mimic recombination intermediates: a partially mobile Holliday Junction and different D-Loops (Fig. 3C and 3D). The analysis of the reaction of AtRECQ2 on Holliday Junctions reveals splayed arm products, characteristic for branch migration. As it was shown before by others, splayed arm is the main product of many RecQ-helicases - also for HsWRN [25]. D-Loops are formed in an early step of homologous recombination, when an ssDNA invades the homologous dsDNA and pairs with the complementary strand of the duplex. AtRECQ2 can displace invading strands of D-Loops, regardless if there is a protruding ssDNA or not, and irrespectively of the protruding ssDNA's directionality. The analyzed bubble was partly unwound. Melting of productive D-Loops in which the 3' end of ssDNA is invading can be considered as anti-recombinogenic. Also, unwinding of the unproductive D-Loops with 5' invasions and 3' protruding tails by RecQ-helicases may be important. The data of other RecQ helicases on their action on D-Loops are published. Whereas some RecQ proteins show a preference for 3' tailed D-Loops, the properties of HsWRN [26] are similar to those of AtRECQ2: the invading strands of all three D-Loop substrates are similarly well displaced.

To sum up, the biochemical properties of AtRECQ2 are closest to those of HsWRN. Therefore, the hypothesis that those two are functionally homologous is reinforced and it will be highly interesting to see

whether the future analysis of the respective T-DNA insertion mutants will sustain this conclusion.

In general, we can summarize that a reasonable number of genes involved in genome stability and cancer predisposition in animals are well-conserved in plants. The function of these genes is often similar on a general level, such as the preservation of genome stability, as well as regarding their biochemical properties. Nevertheless, besides helping to understand basic mechanisms of genome stability in eukaryotes, our research also has a strong biotechnological potential. A better understanding of homologous recombination in plants might help us to set up new approaches in green gene technology, such as gene targeting or improved breeding.

ACKNOWLEDGEMENTS

We want to thank S. Blanck, K. Demand, W. Reidt, R. Wurz-Wildersinn, S. Hettinger, C. Moock, S. Buss and S. Zeiler for their contribution to this article. We want to apologize that, due to space limitation, we were not able to cite all the relevant literature. This work was supported by DFG grants HA5055/1-1 and PU137/10-1.

BIBLIOGRAPHY

- Miki, Y. *et al.* A strong candidate for the breast and ovarian cancer susceptibility gene BRCA1. *Science* **266**, 66–71 (1994).
- Wooster, R. *et al.* Identification of the breast cancer susceptibility gene BRCA2. *Nature* **378**, 789–92 (1995).
- Siaud, N. *et al.* *Brca2* is involved in meiosis in *Arabidopsis thaliana* as suggested by its interaction with *Dmc1*. *Embo J.* **23**, 1392–1401 (2004).
- Lafarge, S., And Montane, M.H. Characterization of *Arabidopsis thaliana* ortholog of the human breast cancer susceptibility gene 1: *AtBRCA1*, strongly induced by gamma rays. *Nucleic Acids Res* **31**, 1148–55 (2003).
- Reidt, W., Wurz, R., Wanieck, K., Chu, H.H., Puchta, H. A homologue of the breast cancer-associated gene BARD1 is involved in DNA repair in plants. *Embo J.* **25**, 4326–37 (2006).
- Sharan, S.K. *et al.* Embryonic lethality and radiation hypersensitivity mediated by Rad51 in mice lacking *Brca2*. *Nature* **386**, 804–810 (1997).
- Gowen, L.C. *et al.* *Brca1* deficiency results in early embryonic lethality characterized by neuroepithelial abnormalities. *Nature Genetics* **12**, 191–94 (1996).
- Mccarthy, E.E., Celebi, J.T., Baer, R., Ludwig, T. Loss of Bard1, the heterodimeric partner of the *Brca1* tumor suppressor, results in early embryonic lethality and chromosomal instability. *Mol Cell Biol* **23**, 5056–63 (2003).
- Ouyang, K.J., Woo, L.L., Ellis, N.A. Homologous recombination and maintenance of genome integrity: Cancer and aging through the prism of human *RecQ* helicases. *Mech Ageing Dev* Mar 15 [Epub Ahead Of Print] (2008).
- German, J., Sanz, M.M., Ciocci, S., Ye, T.Z., Ellis, N.A. Syndrome-causing mutations of the BLM gene in persons in the Bloom's Syndrome Registry. *Hum. Mutat.* **28**, 743–53 (2007).
- Yu, C.E. *et al.* Positional cloning of the Werner's syndrome gene. *Science* **272**, 258–62 (1996).
- Ellis, N.A. *et al.* The Bloom's syndrome gene product is homologous to *RecQ* helicases. *Cell* **83**, 655–66 (1995).
- Kitao, S. *et al.* Mutations in RECQL4 cause a subset of cases of Rothmund-Thomson syndrome. *Nat Genet.* **22**, 82–84 (1999).
- Hartung, F., Puchta, H. The *RecQ* gene family in plants. *Journal Of Plant Physiology* **163**, 287–296 (2006).
- Hartung, F., Suer, S., Puchta, H. Two closely related *RecQ*-helicases have antagonistic roles in homologous recombination and DNA repair in *Arabidopsis thaliana*. *Proc Natl Acad Sci Usa* **104**, 18836–841 (2007).
- Hartung, F., Suer, S., Puchta, H. The Role of *AtMUS81* in DNA Repair and its Genetic Interaction with the Helicase *AtRecQ4A*. *Nucleic Acids Res.* **34**, 4438–48 (2006).
- Watt, P.M., Louis, E.J., Borts, R.H., Hickson, I.D. Sgs1: a eukaryotic homolog of *E. coli RecQ* that interacts with topoisomerase II *in vivo* and is required for faithful chromosome segregation. *Cell* **81**, 253–60 (1995).
- Langlois, R.G., Bigbee, W.L., Jensen, R.H., German, J. Evidence for increased *in vivo* mutation and somatic recombination in Bloom's syndrome. *Proc Natl Acad Sci Usa* **86**, 670–4 (1989).
- Mankouri, H.W. And Hickson, I.D. The *RecQ* helicase-topoisomerase III-Rmi1 complex: a DNA structure-specific 'dissolvosome'? *Trends Biochem Sci.* **32**, 538–46 (2007).
- Kobbe, D., Blanck, S., Demand, K., Focke, M., Puchta, H. *AtRECQ2*, a *RecQ*-helicase homologue from *Arabidopsis thaliana*, is able to disrupt different recombinogenic DNA-structures *in vitro*. *Plant J.* **55**, 397–405 (2008).
- Hartung, F., Plchova, H., Puchta, H. Molecular characterisation of *RecQ* homologues in *Arabidopsis thaliana*. *Nucleic Acids Res.* **28**, 4275–82 (2000).
- Plchova, H., Hartung, F., Puchta, H. Biochemical characterization of an exonuclease from *Arabidopsis thaliana* reveals similarities to the DNA exonuclease of the human Werner syndrome protein. *J. Biol. Chem.* **45**, 44128–138 (2003).
- Macris, M.A., Krejci, L., Bussen, W., Shimamoto, A., Sung, P. Biochemical characterization of the RECQ4 protein, mutated in Rothmund-Thomson syndrome. *DNA Repair (Amst.)* **5**, 172–80 (2006).
- Shen, J.C., Gray, M.D., Oshima, J., Loeb, L.A. Characterization of Werner syndrome protein DNA helicase activity: directionality, substrate dependence and stimulation by replication protein A. *Nucleic Acids Res.* **26**, 2879–85 (1998).
- Mohaghegh, P. *et al.* The Bloom's and Werner's syndrome proteins are DNA structure-specific helicases. *Nucleic Acids Res.* **34**, 2269–79 (2001).
- Orren, D.K., Theodore, S., Machwe, A. The Werner syndrome helicase/exonuclease (WRN) disrupts and degrades D-loops *in vitro*. *Biochemistry* **41**, 13483–8 (2002).

Genomic and Gene-specific Induction and Repair of DNA Damage in Barley

V Manova*, M Georgieva, B Borisov, B Stoilova, K Gecheff & L Stoilov

Abstract

Repair of DNA damage induced by various mutagenic agents within the barley genomic and ribosomal DNA was the subject of investigation. Reconstructed karyotypes T-1586 and T-35, with normal and increased expression of ribosomal genes respectively, were utilized to evaluate the relationship between the transcriptional activity and the rate of DNA damage induction and their repair. A tendency towards restoration of rDNA integrity after γ -irradiation was observed, indicative for the efficient recovery of double-strand breaks in barley ribosomal DNA. Ability of barley ribosomal genes to cope with damage produced *in vivo* by the radiomimetic agent bleomycin was further analyzed. Preferential sensitivity of barley linker DNA towards bleomycin treatment *in vivo* was established. Fragments containing intergenic spacers of barley rRNA genes displayed higher sensitivity to bleomycin than the coding sequences. No heterogeneity in the repair of DSB between transcribed and non-transcribed regions of ribosomal genes was detected. Data indicated that DSB repair in barley ribosomal genes, although relatively more efficient than in genomic DNA, did not correlate with NOR activity. Repair kinetics of UV-C induced cyclobutane pyrimidine dimers in barley genomic and ribosomal DNA was also studied. Less cyclobutane pyrimidine dimers (CPD) in rDNA in comparison to total genomic DNA was detected. Results showed that UV-C induced CPD in barley ribosomal genes are as efficiently repaired as in the rest of the genome predominantly by light repair mechanisms.

Introduction

Maintenance of DNA integrity by the cellular repair mechanisms is an essential function of living organisms, preserving the genuine status of their genetic information. DNA repair mechanisms are also not fully correct, which increases the genetic diversity and variability of the populations. The biological consequences of non-repaired or miss-repaired DNA damage depend on the type and frequency of the lesions as well as on the functional characteristics and location of the target DNA. Therefore, the investigations on the selective induction and differential efficiency of repair processes in individual genes and defined DNA sequences are of substantial theoretical and practical importance.

Many studies have shown that the heterogeneity of DNA damage induction and repair, dependent on chromatin organization, transcriptional activity and nature of individual DNA sequences, is a widely spread phenomenon in higher eukaryotes. A crucial breakthrough in the topic of differential repair was the finding that actively transcribed genes are more quickly repaired by nucleotide excision repair (NER) than non-expressed ones. It was further demonstrated that such preferential recovery of active genes was mainly due to the accelerated repair of lesions in the transcribed DNA strand [1, 2]. Moreover, intragenic repair heterogeneity, reflecting chromatin alterations along the genes was also established [3, 4]. After the initial observation for strand-specific repair

of cyclobutane pyrimidine dimers, the link between DNA repair and transcription for other types of DNA lesions has been extensively studied. Recovery from damage induced by UV, crosslinking and alkylating agents in mammalian ribosomal (rRNA) genes, however, was found to be less effective than in genes transcribed by RNA polymerase II or in the genome overall [5-7]. Efficient, but not preferential, repair was observed for bleomycin and IR-induced strand breaks in mammalian rRNA genes [8, 9] indicating that repair of rDNA might be rather lesion-dependent than tightly linked to transcription. Recently, however, a transcription-dependent repair of UV-induced CPD in yeast rRNA genes accomplished by NER and photoreactivation has been demonstrated [10]. Studies on the gene-specific induction and repair of DNA damage in plants, however, are limited and there is a lack of information about the existence of preferential DNA repair of active plant genes in relation to their transcriptional activity, chromatin structure and genomic location.

Description of the activities performed

Our main research activities were focused on the genomic and gene-specific induction and repair of DNA damage in barley. The induction and repair kinetics of double-strand breaks (DSB) in barley ribosomal DNA (rDNA) after treatment of root tips with ionizing radiation and bleomycin were investigated. The relationship between transcriptional activity of ribosomal genes and the efficiency of induction and repair of these lesions in whole barley repeats, as well as in the transcribed and non-coding rDNA sequences were also analyzed. Formation and repair of CPD in genomic (gDNA) and ribosomal DNA after UV-C irradiation of barley leaves were also a subject of investigation.

Ionizing radiation-reconstructed barley karyotypes T-1586 and T-35 characterized with normal and increased activity of Nucleolus Organizing Regions (NOR) were utilized to study the link between the repair potential of barley ribosomal genes and their expression. Line T-35 is derived from T-1586 and contains deletion of the NOR-bearing segment of chromosome 6H. As a result, a higher activity of the remaining rRNA gene cluster localized in NOR 5H was observed [11, 12]. Barley ribosomal genes are represented by long (9.8 kb) and short (8.8 kb) ribosomal repeats, localized in the NOR of chromosome 6H and 5H respectively (Fig. 1).

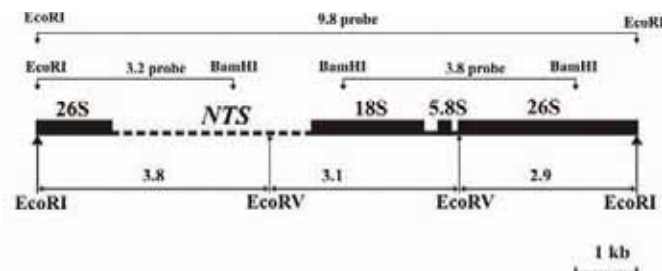

Figure 1 Partial restriction map of the longer 9.8 kb barley rDNA repeat (clone HV 014). Solid and dotted lines represent coding regions and non-transcribed intergenic spacer respectively.

Institute of Genetics "Acad. D. Kostoff", Bulgarian Academy of Sciences

* Corresponding author. E-mail: vmanova@bas.bg

Repair of ionizing-radiation induced DSB in barley ribosomal genes

Ionizing radiation was initially used for generation of DSB in barley ribosomal DNA. Kinetics of DSB induction obtained after treatment of germinating seeds from karyotypes T-1586 and T-35 with gamma-rays is outlined in Fig. 2. It was found that 100Gy gamma-rays produce DSB in rDNA, resulting in a detectable decrease of the corresponding hybridization signal. Although the yield of DSB in both rDNA repeats immediately after irradiation was relatively low, after a further three hours of germination a higher amount of DNA damage in the respective gene clusters was detected. After a 24-hour recovery of the root seedlings, the integrity of rDNA reached the control values. These data indicate the existence of efficient recovery mechanisms for DSB in barley rDNA. The observed lack of correlation between the expression of barley rRNA genes and their sensitivity against radiation-induced damage is in accordance with the proposed uniform distribution of the repair activities responsible for double-strand breaks in mammalian cells. The results favour a mechanism for induction of DSB in barley ribosomal genes, presumably uncoupled with their transcription [13].

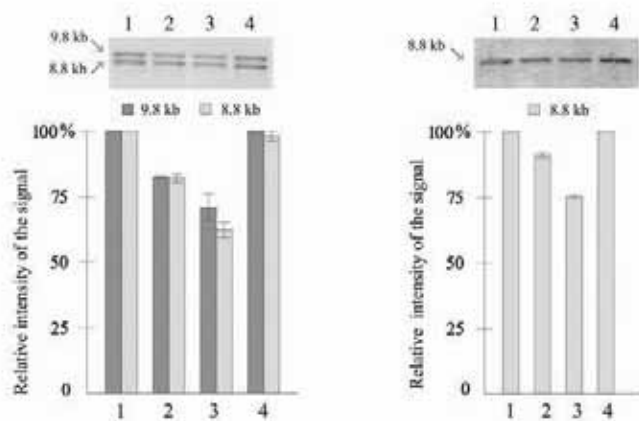

Figure 2 Hybridization profiles of rDNA repeats and histogram representation of the densitometric data (in arbitrary units) obtained after irradiation of germinating seeds from karyotype T-1586 and deletion line T-35. Intensity of the signal in the untreated control sample is taken as 100%. Lane 1, 2, 3 and 4 - control, 0, 3 and 24 hours recovery.

Repair of bleomycin-induced double-strand breaks in barley genomic DNA and ribosomal genes

Repair kinetics of damage induced by bleomycin (200µg/ml) in barley genomic DNA was assessed by conventional gel electrophoresis under neutral and alkaline conditions for DSB and SSB respectively (Fig. 3). A distinctive feature of DSB profiles was their nucleosomal-phased fragmentation due to the higher sensitivity of barley linker DNA towards bleomycin treatment *in vivo*.

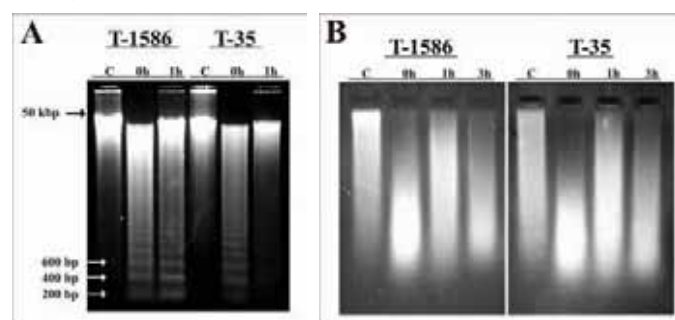

Figure 3 Neutral (A) and alkaline (B) ethidium bromide-stained gels visualizing the induction and repair of DSB (A) and SSB (B) in barley genomic DNA. C - untreated DNA; 0h, 1h and 3h - recovery periods after bleomycin treatment.

Comparison of the yields of initially induced DSB in ribosomal and genomic DNA revealed an increased sensitivity of gDNA, whereas rDNA was somewhat more resistant to DSB induction by bleomycin. Taking into account that in barley only a small proportion of about 4000 rRNA genes is actively transcribed, chromatin compactness appeared as one of the possible factors determining the observed differences. Data showed efficient repair of bleomycin-induced SSB and DSB in genomic DNA of both karyotypes after one hour of repair. Recovery kinetics of DSB in ribosomal DNA generally followed that found in genomic DNA (Fig. 4). Both lines displayed even higher capacity for repair of DSB in rDNA compared to bulk DNA. At first glance, repair of ribosomal genes in T-35 appears to be more effective than in T-1586, but this could actually reflect the overall repair capacity of this line. On the other hand, the existence of putative inactive rDNA repeats still residing in NOR 5H might obscure the visualization of fast repair in transcribed genes. As a whole, however, the results support the notion that the repair efficiency of bleomycin-induced DSB in barley ribosomal genes was not substantially affected by the overall activity of the respective barley NORs [14].

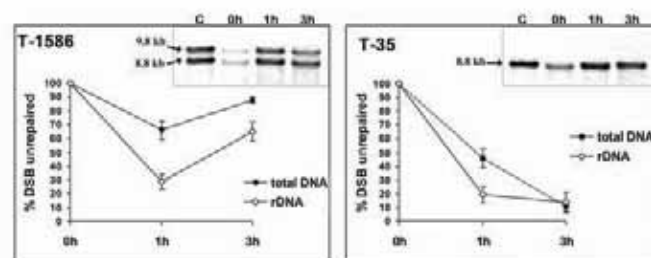

Figure 4 Comparative data representing the efficiency of DSB repair in rDNA and total genomic DNA from karyotypes T-1586 and T-35. Initial rate of DSB, measured at time point 0h was assumed as 100% damage. Accordingly, repair levels were expressed as percentage of DSB left unrepaired during the recovery periods (one hour and three hours).

Comet assay was applied to analyze the induction and repair kinetics of DSB and SSB produced by bleomycin in barley supercoiled DNA loop domains (Fig. 5). Data have shown an effective repair of DSB within the first 15 minutes after application of bleomycin to barley root tips. Percentage of the remaining damage after one hour of repair was about 50% from the initial one after treatment with a lower bleomycin dose. Surprisingly, an even more pronounced recovery was observed after application of the highest bleomycin concentration (Fig. 6).



Figure 5 Microphotographs of the representative comet images obtained after application of neutral (A) and alkaline (B) comet assay.

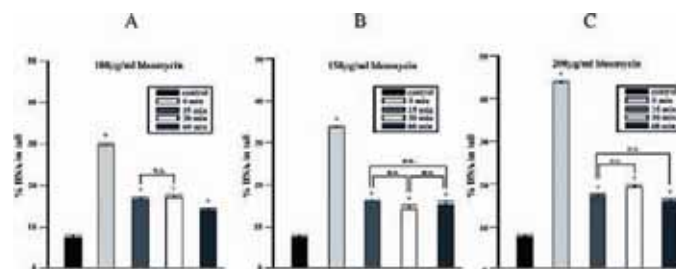

Figure 6 DSB repair based on % DNA in tail (±SE) in *Hordeum vulgare* root tips cells at various recovery periods after treatment with bleomycin. (A): 100 µg/ml; (B): 150 µg/ml; (C): 200 µg/ml. *GLM (P<0.001). n.s. No significant differences.

The frequency of initially induced SSB was not substantially influenced by the bleomycin concentrations applied. Observed repair efficiency was significantly higher at 50µg/ml shortly after treatment and remained steady afterward. After application of 100µg/ml, however, at least one hour of recovery was necessary for the cells to reach the levels of DNA damage detected 15 minutes after treatment with the lower bleomycin concentration (Fig. 7) [15].

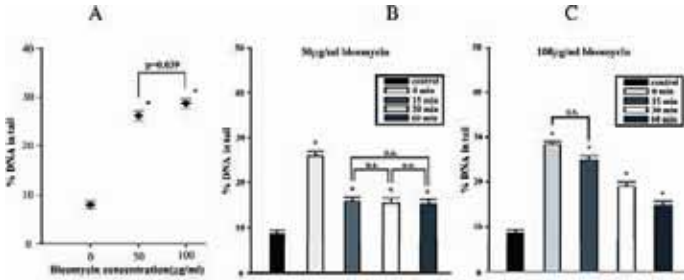

Figure 7 Initial induction (A) and recovery kinetics (B, C) of DNA breaks induced by bleomycin detected by alkaline comet assay. *GLM (P<0.001). n.s. No significant differences.

Induction and repair of DSB in defined domains of barley ribosomal genes

As the ribosomal repeat comprises sequences with different chromatin organization and transcriptional status, the induction and repair of bleomycin-induced DSB within the defined regions of ribosomal genes was analyzed. Data for the number of initially induced DNA damage showed preferential induction of DSB within the fragments comprising non-transcribed sequences (3.8 kb and 2.8 kb respectively), in comparison to that covering the structural part of the genes (fragments 3.1 kb and 2.9 kb) (Fig. 8).

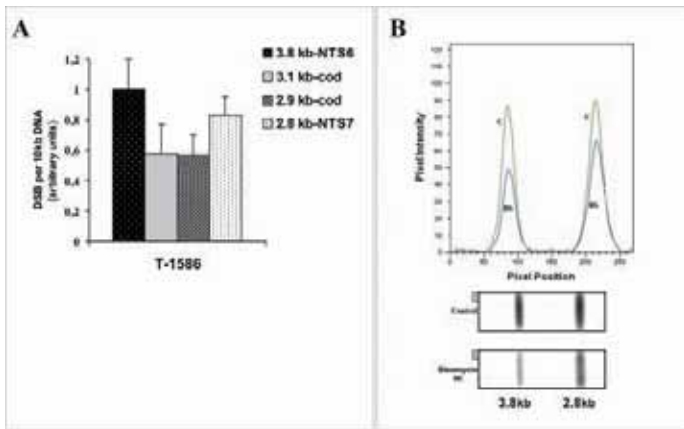

Figure 8 (A) Differential distribution of DSB within specific regions of barley ribosomal genes. Double-digested DNA from line T-1586 was hybridized consecutively with 3.2kb probe (detecting the non-transcribed spacers) and 3.8kb probe (for the coding regions only). (B) Densitometric and hybridization profiles of 3.8kb and 2.8kb non-transcribed spacers from both rDNA clusters in line T-1586, obtained with the 3.2kb probe: 1- control, 2- immediately after bleomycin treatment.

On the other hand, we did not find substantial differences between the repair kinetics of bleomycin-induced DSB within the transcribed and non-transcribed ribosomal sequences (Fig. 9). To our knowledge, data on the induction and repair of damage in specific regions of plant genes have not been previously reported. Increased sensitivity to DSB found in barley non-transcribed spacer might reflect a higher density of repeated elements with enhancer and promoter functions, which in concert with the relatively relaxed chromatin structure, might render this area more

vulnerable to damage induction. Lack of differential repair efficiency in transcribed and non-transcribed regions of barley ribosomal genes in both lines, implied that their distinct transcription-dependent chromatin organization did not influence the repair of bleomycin-induced DSB in these specific domains. Our data indicated that the repair of this damage in barley rRNA gene clusters, although more efficient than in total genomic DNA, did not correlate with the overall NOR activity [14].

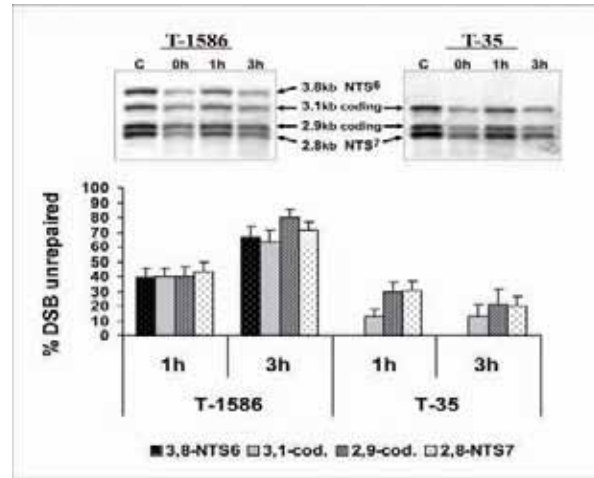

Figure 9 DSB repair efficiency within specific regions of barley ribosomal genes of karyotypes T-1586 and T-35. Repair was expressed as percentage of DSB left in the ribosomal fragments during the recovery periods (one and three hours). Representative Southern blots obtained after hybridization with 9.8kb probe of EcoRI/EcoRV-digested control and treated DNA, in order to differentiate the coding from spacer regions of rDNA repeats, are also inserted.

Induction and repair of CPD in barley genomic and ribosomal DNA

Barley seedlings were irradiated with various UV-C doses in the range 0.5-5 J/cm² and subsequently incubated for different repair intervals. CPD repair was investigated at the level of genomic and ribosomal DNA in the first leaf of six-day-old seedlings under light and dark conditions. Data showed obvious prevalence of light repair mechanisms in barley leaves even after high doses of UV-C irradiation. Less amount of CPD in rDNA in comparison to total genomic DNA immediately after irradiation was detected. Kinetics of CPD repair was found to be similar in the genomic and ribosomal DNA (unpublished data). These results indicate that UV-C induced CPD in barley ribosomal genes are as efficiently repaired as in the rest of the genome (Fig. 10).

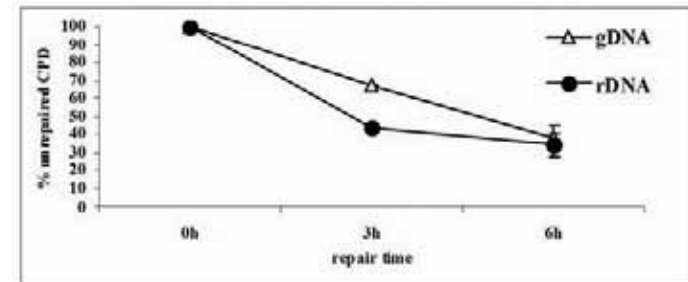

Figure 10 Efficiency of light CPD repair in barley genomic and ribosomal DNA.

Conclusions

Altogether, the data suggested the operation of efficient repair mechanisms maintaining the integrity of barley total genomic DNA and

ribosomal genes after treatment with different types of mutagenic agents such as ionizing radiation, bleomycin and UV-C light. The results also showed that, particularly for IR and bleomycin induced DSB, there was no noticeable relationship between the transcriptional activity of rRNA genes and their repair potential.

ACKNOWLEDGEMENTS

This work was supported by the IAEA Research contract № Bul 12608/RO/RBF and grants from Bulgarian National Science Fund - Genomics Programme, Contract No G-1-01 and Grant No K-804.

BIBLIOGRAPHY

- Mellon, I., Spivak, G., Hanawalt, P.C. Selective removal of transcription blocking DNA damage from the transcribed strand of the mammalian DHFR gene. *Cell* **51**, 241-249 (1987).
- Friedberg, E.C. Relationship between DNA repair and transcription. *Annu. Rev. Biochemistry* **65**, 15-42 (1996).
- Hu, W., Feng, Z., Chasin, L.A., Tang, M.-S. Transcription-coupled and transcription-independent repair of cyclobutane pyrimidine dimers in the dihydrofolate reductase gene. *J. Biol. Chem.* **277**, 38305-38310 (2002).
- Meier, A., Thoma, F. RNA polymerase I transcription factors in active yeast rRNA gene promoters enhance UV damage formation and inhibit repair. *Mol. Cell. Biol.* **25**, 1586 - 1595 (2005).
- Stevnsner, T., May, A., Petersen, L.N., Larminat, F., Pirsell, M., Bohr, V.A. Repair of ribosomal RNA genes in hamster cells after UV irradiation, or treatment with cisplatin or alkylating agents. *Carcinogenesis* **14**, 1591-1596 (1993).
- Christians F.C., Hanawalt, P.C. Lack of transcription-coupled repair in mammalian ribosomal RNA genes. *Biochemistry* **32**, 10512-10518 (1993).
- Fritz L.K., Smerdon, M.J. Repair of UV damage in actively transcribed ribosomal genes. *Biochemistry* **34**, 13117-13124 (1995).
- Fritz, L.K., Suquet, C., Smerdon, M.J. Strand breaks are repaired efficiently in human ribosomal genes. *J.Biol. Chem.* **271**, 12972-12976 (1996).
- Ljungman, M. Repair of radiation-induced DNA strand breaks does not occur preferentially in transcriptionally active DNA. *Radiat. Res.* **152**, 444-449 (1999).
- Meier, A., Livingstone-Zatchej, M., Thoma, F. Repair of active and silenced rDNA in yeast: the contributions of photolyase and transcription-coupled nucleotide excision repair. *J. Biol. Chem.* **277**, 11845-11852 (2002).
- Gecheff, K. Cytogenetic study on a barley translocation line and some conclusions concerning chromosome karyogram designation. *Genet. Pl. Breed.* **11**, 17-22 (1978).
- Gecheff, K.I., Chvarleva, T., Georgiev, S., Wilkes, T., Karp, A. Cytological and molecular evidence of deletion of ribosomal RNA genes in chromosome 6 of barley (*Hordeum vulgare* L). *Genome* **37**, 419-425 (1994).
- Manova, V.I., Stoilov, L. Induction and recovery of double-strand breaks in barley ribosomal DNA. *DNA Repair (Amst.)* **2**, 983-990 (2003).
- Manova, V., Gecheff, K., Stoilov, L. Efficient repair of bleomycin-induced double-strand breaks in barley ribosomal genes. *Mutat. Res.* **601**, 179-190 (2006).
- Georgieva, M., Stoilov, L. Assessment of DNA double-strand breaks produced by bleomycin in barley genome by the comet assay. *Env. Mol. Mutagen.* **49**, 381-387 (2008).

An Approach to Screen and Identify Novel Meiotic Mutants in an EMS Mutant Population

J A da Costa-Nunes* & W Viegas

Abstract

A novel *Arabidopsis* EMS mutant population was produced aiming at identifying until now unknown meiotic mutants. The M_2 EMS mutant families were first screened for their reduced fertility. These plants with a reduced fertility were subjected to a second screening at the cytological level. Plants with abnormal meiosis, namely abnormal chromosome segregation and chromosome fragmentation were selected for further characterization and SNP mutation mapping. So far, 232 sterile and semi-sterile M_2 candidates have been identified in the fertility screen, of which 110 sterile mutants were further analyzed at the cellular level; 15 of these have been analysed at the cytological level. Mapping has been carried out.

Abbreviations

EMS - ethylmethanesulfonate; SNP - Single Nucleotide Polymorphism; M_1 - plants obtained from seeds exposed to EMS; M_2 and M_3 - plants obtained from seeds produced by self-fertilization of M_1 and M_2 plants, respectively; F1 - plants obtained from cross of two different landraces; F_2 - plants obtained from self-fertilization of F_1 plants.

Introduction

During meiosis two major events occur, DNA recombination and two sequential chromosomal segregations. Meiotic DNA recombination takes place between homologous chromosomes and it requires the formation of DNA double strand breaks, strand exchange for repair, and resection and resolution of the entangled recombined DNA strands originated from the two-paired homologous chromosomes. These homologous chromosomes segregate after recombination has occurred, and only during the second division do the sister chromatids segregate [1]. Consequently, in *Arabidopsis* male meiocytes, during the first meiotic division the 10 chromosomes are segregated to the two opposite ends of the cell as five-chromosome units; during the second meiotic division the two groups of homologues divide again, segregating five sister chromatids to each end [2]. The final products of the male meiotic division are four evenly sized haploid cells that remain attached until just after meiosis as a tetrad; the tetrad eventually breaks down and the haploid cells become individualized microspores. In *qrt1/qrt1* mutants however, the four haploid products of meiosis remain in a tetrad even during microsporogenesis and all of the mature pollen stage [3]; this is advantageous for a screen of abnormal male meiotic products (in a tetrad) and hence this mutant was used to produce the EMS mutant population mentioned in this paper.

In *Arabidopsis*, errors in DNA repair and recombination, and/or chromosome cohesion and segregation during meiosis, can lead to

chromosome fragmentation and to the formation of stretched DNA treads during chromosome segregation [4, 5]. Consequently, plants that are homozygous for mutations responsible for these phenotypes, form abnormal meiotic products due to the uneven segregation of the DNA, giving origin to tetrads with unevenly sized microspores, or to the formation of polyads [4]. This leads to impaired fertility.

Despite the current availability of many tagged (T-DNA and transposon) [6, 7, 8] *Arabidopsis* mutants, there are still a number of genes in *Arabidopsis* that are not annotated in the public databases as being disrupted by T-DNA or transposable elements (www.arabidopsis.org). Moreover, there are plenty of *Arabidopsis* genes that are annotated as having an unknown function (www.arabidopsis.org). Hence, it is possible that some of these genes with no assigned function and/or those for which there are no knock-out mutants available, can have a function in meiosis. Thus, a forward genetics approach is still a valid and unbiased method to identify novel meiotic genes. Consequently, a novel EMS *Arabidopsis* mutant population in a *qrt/qrt* background was produced and screened for meiotic mutants.

Approaches to map EMS mutations have been based on the recombination frequency in the vicinity of the mutation, profiting from the polymorphism between ecotypes (landraces). Gross mapping can map the SNP mutation to a chromosome arm, using a small number of individual plants from a M_2 segregating population [9], while fine mapping usually requires a large amount of M_2 individual plants and big workload. Fortunately, the advent of genomic microarray hybridization for mapping has decreased both the amount of workload as well as the number of M_2 individual plants required for mapping SNP mutations [10].

Materials and Methods

Plant material and EMS mutagenesis

qrt1-1/qrt1-1 mutant seeds (Landsberg *erecta* landrace) (obtained from the *Arabidopsis* stock center) were mutagenized with EMS (Sigma - M0880). The seeds were first submerged in water over night at 4°C. The water was removed and replaced with 0.1% and 0.2% EMS in a 0.1M Na_2HPO_4 (pH 5) solution. The seeds remained in this solution, with agitation at room temperature for 18 hours (0.1% EMS) or eight hours (0.2% EMS). The seeds were washed twice (15 minutes each wash) on a 100mM sodium thiosulphate solution. Several washes with distilled water followed. Finally, the seeds were kept in sterile 0.1% agarose solution for three to four days at 4°C, before being sown in soil; protocol was based on reference [11].

EMS mutant fertility screen

The M_1 plants were grown in soil in a greenhouse, the seeds of each stem being harvested separately (two to three different stems per plant). Seeds from each M_1 stem were grown and the fertility screen was carried out in the M_2 families that segregated sterile or semi-sterile EMS mutant plants. Sterile plants that exhibited gross morphological flower defects or were non-pollinated due to short stamen were not taken into account in the

CBA - Instituto Superior de Agronomia, Universidade Técnica de Lisboa, Tapada da Ajuda, P-1349-017 Lisboa, Portugal

* Corresponding author. Current address: Disease and Stress Biology Lab - Instituto de Tecnologia Química e Biológica, Universidade Nova de Lisboa, Av. República, Apartado 127, 2781-901 Oeiras, Portugal, Phone: +351 21 4469653, Fax: +351 21 4411277, E-mail: jcnunes@itqb.unl.pt

fertility screen. Seeds from individual plants were harvested from the selected M_2 families. All plants were grown in soil.

Cytology screen

The cytology screen was carried out by observing megaspores and microspores using Nomarski optics microscopy [12]. Pictures of microspores and megaspores were taken with a Leica DM LBC microscope and an Evolution MP (media cybernetics) camera. Meicytes were prepared as described in [13] and the pictures were captured with a U.V. fluorescence microscope U.V. fluorescence Zeiss Axioskop2 microscope and an Axiocam (Zeiss) camera. The images were processed with the Adobe Photoshop 5.0 programme.

Mapping

Fertile M_3 plants (from M_3 families segregating sterile plants) were crossed to Col-0 landrace (obtained from the *Arabidopsis* stock center). The F_1 plants from these crosses were grown, being the F_2 sterile plants used for mapping. All plants were grown in soil. DNA extraction was carried out as described in [14]. Gross mapping was carried out using primers described in [9]. Ongoing mapping using Affymetrix Arabidopsis microarrays was based on [10].

Results

EMS population reveals a Mendelian segregation

For the M_2 *qrt1-1/qrt1-1* EMS mutagenized families so far screened for their fertility, the segregation ratio observed is in agreement with a Mendelian segregation of a single recessive mutant *locus*. Hence, the mutations in these mutants can be attributed to the creation of a single EMS induced SNP per M_2 family, as far as fertility is concerned.

Table 1. Results of the screen carried out to identify M_2 impaired fertility mutants affecting meiosis

Number of M_2 families screened for impaired fertility	% of fertility impaired M_2 families	Number of M_2 families submitted to the cytology screen	% of M_2 families segregating meiotic mutant candidates
2500	9.28% (232 / 2500) ^a	110	22.73% (25 / 110) ^b

^a - (n° of M_2 families segregating fertility impaired plants / total n° of M_2 families screened)

^b - (n° of M_2 families segregating meiotic mutant candidates / total n° of M_2 families screened in the cytology screen)

Only some (110) out of the 232 M_2 families selected in the impaired fertility screen were subjected to the cytological screen.



Figure 1 Cytological screen for abnormal haploid spores using Nomarski optics microscopy: Abnormal "tetrads" with unevenly sized microspores (a, b, c, and d) due to an abnormal meiotic division (**A and B**). Normal tetrads (**C**) with four (a, b, c, d) evenly sized microspores in the *qrt1-1/qrt1-1* mutant genetic background.

Infertility and meiotic screen

While only a fraction of the produced EMS population has so far been screened, 232 candidate M_2 families (out of approximately 2,500) yielded mutants with a sterile or semi-sterile phenotype (**Table 1**). This high number indicates that not all of these mutants are meiotic mutants. Indeed, the cytological screen showed that many are not meiotic mutants since mitotic nuclear divisions in the microspores and megaspores occurred, at least up to a point, as in fertile plants. Mitotic divisions in micro and megaspores occur in the haploid products (spores) of meiosis

[15]. Of 110 screened M_2 mutants with impaired fertility, only 25 were selected as being putative meiotic mutant candidates (**Table 1**). The observation of microspore polyads and unevenly sized microspores was a crucial criterion in selecting these 25 candidates (**Fig. 1**). Meiotic chromosome spreading [13] was carried out in 15 of the 25 candidates. Most of the meiotic phenotypes exhibited strong phenotypes of abnormal anaphase I (first meiotic chromosome segregation), where stretched DNA and chromosome fragments were observed. Some examples of the phenotypes observed are shown in **Fig. 2**.

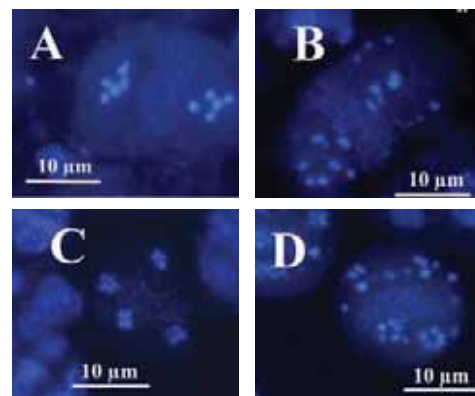

Figure 2 Meiotic stages (DAPI stained) observed in the screened EMS mutants: Normal metaphase II with five chromosomes at each end of the meiotic cell (**A**). Abnormal metaphase II with unequal number of chromosomes at each end, as well as the presence of small chromosome fragments (**B**). Normal end product of meiosis (telophase II) with five chromosomes in each of the four meiotic products (**C**). Abnormal end of meiosis with fragmented chromosomes and chromosome bridges (stretched DNA) (**D**).

Mapping of the SNP mutant

One of the mutants identified in the screen is now being mapped. Gross mapping [9] revealed that the SNP EMS mutation is located on chromosome III, between the molecular markers nga162 and ciw11.

Microarray hybridization on Affymetrix GeneChip® *Arabidopsis* Tiling 1.0R array is being carried out as in [10]. Wild type Col-0 genomic DNA and pooled genomic DNA of 109 individual sterile EMS mutant plants are being used in these hybridizations.

Discussion

This forward genetics approach using a EMS mutant population will allow an unbiased screen (not based on homologies to known genes) which could lead to the discovery of yet unknown and/or plant-specific meiotic genes. Furthermore, by combining three different screens, this approach has the advantage of eliminating most of the non-meiotic sterile mutant candidates at the second screen (by observing the microspores and megaspores of non-fertile plants, see **Fig. 1**). Consequently, a large number of the sterile plants screened after the 2nd screen were indeed shown to be sterile due to abnormal meiotic division, mainly during the first meiotic division. Most of the observed mutations manifested themselves during the first meiotic division, probably due to a defective recombination apparatus, or due to an inefficient release of chromosome cohesion (see **Fig. 2**).

Despite this three-steps screen being a very efficient way of selecting meiotic mutants, it is still labor-intensive and time-consuming. Yet, the combined gross mapping and the Affymetrix GeneChip® *Arabidopsis* Tiling 1.0R array hybridization based mapping (ongoing) are expected to reduce significantly the time and labor invested in mapping.

This three-steps screen combined with a more efficient mapping approach, and complemented with allele tests, should lead to the identification of novel meiotic *Arabidopsis* genes.

ACKNOWLEDGEMENTS

J.A. da C.-N. designed the experiments, carried out the work, and wrote the paper. He was supported by F.C.T. (Fundação para a Ciência e Tecnologia), fellowships (SFRH/BPD/30365/2006) and (SFRH/BPD/7137/2001), and is thankful to W.V. who provided the facilities to carry out the work. The W.V. lab is funded by the F.C.T., Portugal. J.A. da C.-N. also thanks I.G.C. (Instituto Gulbenkian de Ciência, Portugal) for granting access to microscopes.

BIBLIOGRAPHY

- Hamant, O., Ma, H., Cande, W.Z. Genetics of meiotic prophase I in plants. *Annual Review In Plant Biology* **57**, 267-302 (2006).
- Ross, K.J., Frasz, P., Jones, G.H. A light microscopic atlas of meiosis in *Arabidopsis thaliana*. *Chromosome Research* **4**, 507-516 (1996).
- Preuss, D., Rhee, S.Y., Davis, R.W. Tetrad analysis possible in *Arabidopsis* with mutation of the QUARTET (QRT) genes. *Science* **264**, 1458-1460 (1994).
- Bhatt, A.M., Lister, C., Page, T., Frasz, P., Finndlay, K., Jones, G.H., Dickinson, H.G., Dean, C. The *DIF1* gene of *Arabidopsis* is required for meiotic chromosome segregation and belongs to the *REC8/RAD21* cohesin gene family. *The Plant Journal* **19**, 463-472 (1999).
- Bleuyard, J.-Y., Gallego, M.G., Savigny, F., White, C.I. Differing requirements for the *Arabidopsis* Rad51 paralogs in meiosis and DNA repair. *The Plant Journal* **41**, 533-545 (2005).
- Sessions, A., Burke, E., Presting, G., Aux, G., Mcelver, J., Patton, D., Dietrich, B., Ho, P., Bacwaden, J., Ko, C., Clarke, J.D., Coton, D., Bullis, D., Snell, J., Miguel, T., Hutchison, D., Kimmerly, B., Mitzel, T., Katagiri, F., Glazebrook, J., Law, M., Goff, S.A. A high-throughput *Arabidopsis* reverse genetics system. *Plant Cell* **14**, 2985-94 (2002).
- Alonso, J.M., Stepanova, A.N., Leisse, T.J., Kim, C.J., Chen, H., Shinn, P., Stevenson, D.K., Zimmerman, J., Barajas, P., Cheuk, R., Gadrinab, C., Heller, C., Jeske, A., Koesema, E., Meyers, C.C., Parker, H., Prednis, L., Ansari, Y., Choy, N., Deen, H., Geralt, M., Hazari, N., Hom, E., Karnes, M., Mulholland, C., Ndubaku, R., Schmidt, I., Guzman, P., Aguilar-Henonin, L., Schmid, M., Weigel, D., Carter, D.E., Marchand, T., Risseuw, E., Brogden, D., Zeko, A., Crosby, W.L., Berry, C.C., Ecker, J.R. Genome-Wide Insertional Mutagenesis of *Arabidopsis thaliana*. *Science* **301**, 653-657 (2003).
- Rosso, M.G., Li, Y., Strizhov, N., Reiss, B., Dekker, K., Weisshaar, B. An *Arabidopsis thaliana* T-DNA mutagenized population (GABI-Kat) for flanking sequence tag-based reverse genetics. *Plant Molecular Biology* **53**, 247-259 (2003).
- Lukowitz, W., Gillmor, C.S., Scheible, W.-R. Positional cloning in *Arabidopsis*. Why it feels good to have a genome initiative working for you. *Plant Physiology* **123**, 795-805(2000).
- Hazen, S.P., Borevitz, J.O., Harmon, F.G., Pruned-Paz, J.L., Schultz, T.F., Yanovsky, M.J., Liljegren, S.J., Ecker, J.R., Kay, S.A. Rapid array mapping of circadian clock and developmental mutations in *Arabidopsis*. *Plant Physiology* **138**, 990-997 (2005).
- Jander, G., Baerson, S.R., Hudak, J.A., Gonzalez, K.A., Gruys, K.J., Last, R.L. Ethylmethanesulfonate saturation mutagenesis in *Arabidopsis* to determine frequency of herbicide resistance. *Plant Physiology* **131**, 139-146 (2003).
- Yadegari, R., De Paiva, G.R., Laux, T., Koltunow, A.M., Apuya, N., Zimmerman, J.L., Fischer, R.L., Harada, J.J., Goldberg, R.B. Cell differentiation and morphogenesis are uncoupled in *Arabidopsis* raspberry embryos. *The Plant Cell* **6**, 1713-1729 (1994).
- Armstrong, S.J., Franklin, F.C.H., Jones, G.H. Nucleolus-associated Telomere clustering and pairing precede meiotic chromosome synapsis in *Arabidopsis thaliana*. *Journal Of Cell Science* **114**, 4207-4217 (2001).
- Edwards, K., Johnstone, C., Thompson, C. A simple and rapid method for the preparation of plant genomic DNA for PCR analysis. *Nucleic Acids Research* **19**, 1349 (1991).
- Da Costa-Nunes, J.A., Grossniklaus, U. Unveiling the gene-expression profile of pollen. *Genome Biology* **5**, 205.1-205.3 (2003).

CONCURRENT SESSION 4

Induced Mutations for Traits that Affect Abiotic Stress Tolerance and Adaptation to Climate Change

Systematic Phenotype Analysis of *Arabidopsis* *Ds*-tagged Mutants to Unravel Gene Functions in Abiotic Stress Response as well as Growth and Development

T Kuromori & K Shinozaki*

Abstract

By the availability of various mutant resources in *Arabidopsis*, it is now possible to investigate mutant lines for almost every gene. *Arabidopsis* is then, not only a model plant for plant research, but also a model species in which it is possible to carry out “saturation mutagenesis” for all genes, and to totally analyze each gene and mutant of one organism. One of the future goals of the “phenome” project is to collect information about the knockout-type mutant phenotypes for each *Arabidopsis* gene. We have generated thousands of *Dissociation* (*Ds*) transposon-tagged lines, which have a single insertion because of an advantage of the *Activator/Dissociation* (*Ac/Ds*) system, and deposited it to the RIKEN BioResource Center. In this resource, we selected 4,000 transposon-tagged lines with a transposon insertion in gene-coding regions, and systematically observed the visible phenotype of each line as a first step of phenome analysis. In total, about 200 clear visible phenotypes were classified into 43 categories of morphological phenotypes. Phenotypic images have been entered into a searchable database. Parallel to this, we have been selecting homozygous transposon-insertional plants, which would be useful resources to detect other phenotypes besides the visible ones. We are setting three categories of measurement to search various traits for total phenome analysis, such as physical, chemical or biological methods. Recently, we started to investigate biologically-measured phenotypes, which are stress-responsive or conditional phenotypes, using homozygous mutant resources. We are also collecting any mutant phenotype information from published reports in journal research activity to make a comprehensive phenotype database of *Arabidopsis* genes and mutants.

Introduction

Analysis of genetic mutations is an effective technique for investigating genetic function. Today, a wide variety of mutant organisms and cells created from gene silencing in model organisms is available for mass production, and great progress is being made in the use of tools for phenotype analysis [1–3]. RNAi gene silencing has been widely used in *Caenorhabditis elegans* and *Drosophila* [2,3]. In *Arabidopsis*, insertion mutations can be produced using transferred DNA (T-DNA) or transposons, making it possible to monitor the effects of changes in a single gene. Through self-pollination for maintaining progeny and through bulk storage of mutations in the form of seeds—not an option in animal models—it is now feasible to use insertion mutations to analyze every gene in the *Arabidopsis* genome. This makes *Arabidopsis* useful not only as a model organism for plant research, but also as the only multicellular organism in which it is currently possible to perform “saturation mutagenesis” to create knockout strains for each gene. Since the completion of sequencing of the *Arabidopsis* genome in 2000, an international team has been working to collect approximately 26,000 individual genes and to catalogue the functional genomics of the entire genome [4]. To

contribute to this international project, we have generated transposon-tagged lines as a resource for *Arabidopsis* mutations, and are pursuing systematic phenotype analysis (phenome analysis). Since saturation mutagenesis is feasible in *Arabidopsis*, our goal is to prepare a gene encyclopedia that will catalogue the phenotypes for a variety of gene knockout strains.

Determining the insertion site for transposon insertion mutations

We generated transposon-tagged lines as a gene knockout mutant resource for research in functional genomics of *Arabidopsis*. In T-DNA insertion mutants, multiple T-DNA insertions have been reported [5]. However, using a transposon *Ac/Ds* system, it is possible to generate mutants with a high proportion of single-copy transposon insertions. This has the advantage of simplifying the production and subsequent genetic analysis of a single gene knockout system [6]. Using the transposon *Ac/Ds* system developed by Dr. N.V. Fedoroff et al., we have generated a total of 18,000 independent transposon-tagged lines [7–9]. In addition, we have used sequence analysis in the vicinity of the transposon to determine the transposon insertion site within the genome for each tag line, and are publishing the insertion site information (<http://rarge.gsc.riken.go.jp/>) [7–10]. The mutant lines included here have been deposited with the RIKEN BioResource Center (RIKEN BRC) for worldwide distribution (<http://www.brc.riken.jp/lab/epd/>).

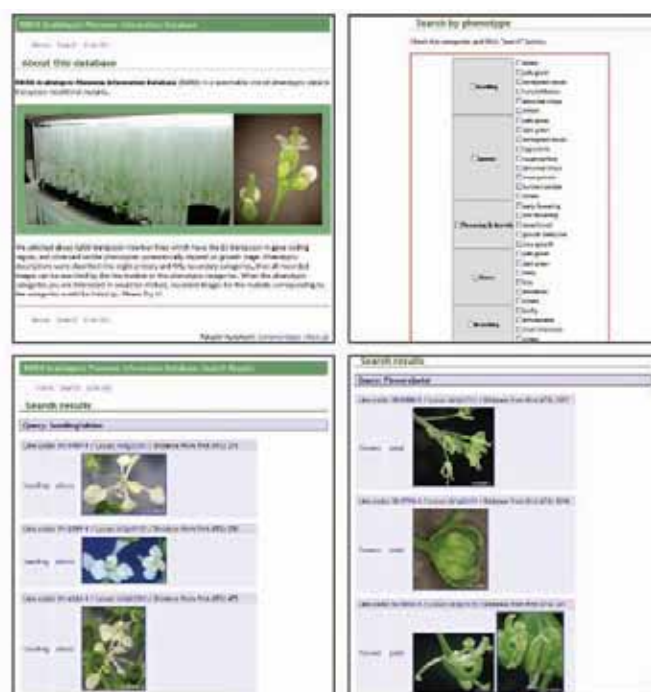

Figure 1 Top page of RAPID (RIKEN *Arabidopsis* Phenome Information Database) (upper left), search page of the database (upper right), and examples of search results (lower left and right).

Gene Discovery Research Group, RIKEN Plant Science Center, Yokohama, Japan

* Corresponding author. E-mail: sinozaki@rtc.riken.jp

Phenotype analysis (phenome analysis) and creation of database

Next, as one method for implementing full-genome analysis that makes use of such a mutant resource, we reviewed the tagged lines that have been generated to date. We have selected the lines for which the transposon was inserted in the gene-coding region, and are conducting systematic phenotypic analysis (phenome analysis) for each line in approximately 4,000 genetic mutations. Up to this point, we have focused primarily on the morphological characteristics of external appearance (visible phenotypes). Through the stages of growth, we look at seedlings, leaves, stems, flowers, fruits (siliques), seeds, overall growth, and branching. We have established a total of eight categories and 43 detailed subcategories for classifying the phenotype data that we have obtained. Those mutations that show relatively clear aboveground morphological abnormalities with confirmed reproducibility are entered in a published database of mutations that permits searching by phenotypic category (RAPID: RIKEN *Arabidopsis* Phenome Information Database) (<http://rarge.gsc.riken.jp/phenome/>) (Fig. 1) [11].

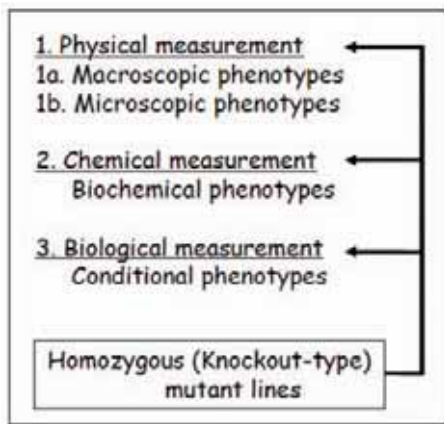

Figure 2 Application of mutant lines for various methods of phenotyping.

This database includes approximately 200 pages of image data, enabling users to search for a specific mutation by selecting the phenotypic category on the search screen. Search results are displayed as thumbnail images. One click enlarges the thumbnail to a full-size photograph, permitting the visual inspection of a mutation that would be quite difficult to describe in words. For each mutation that we observe, we indicate into which gene the transposon has been inserted, and look forward to progressively analyzing each mutant.

Phenotype parameters measured and the effective use of homozygous insertion mutants

The visible phenotypes currently entered in the database can be considered macroscopic phenotypes, representing a physically quantifiable portion of the data measured from phenome analysis. At the present stage, many mutant lines show no obvious morphological abnormalities in the visible phenotype, and no phenotype has been entered. For these lines, we are currently building up mutant lines with homozygous transposon insertion. We believe that these will be a novel resource for the gene knockout systems needed to investigate phenotypes that we have not monitored up to this point, including biochemical changes not externally visible as morphologic abnormalities (biochemical phenotypes), phenotypic response to stress (conditional phenotypes), and physical phenotypic qualities at the cellular level that cannot be determined without instruments (microscopic phenotypes) (Fig. 2). Recently, we started to investigate stress-responsive or conditional phenotypes from homozygous mutant resources. We are performing a high throughput stress examination using multi-titer plates to check germination and seedling growth under abiotic stress or abscisic acid treatment.

Homozygous mutant lines will also yield materials for gene knockout systems that not only can be applied one-by-one in phenotypic analysis, but also can be useful in generating double mutants and multiple mutants. In the future, we anticipate further progress in international cooperation in recording phenotypes in a format that increases the parameters for the variety of mutations in the entire *Arabidopsis* genome, and in methods

AGI code	Gene symbol	Homology	References	Phenotypes
At1g01290	CNX3	molybdopterin synthase	PNAS, 102, 3129-3134, 2005	retinol resistant
At1g02065	SPL8	plant-specific proteins that share a h	Plant Cell, 15, 1009-1019, 2003	strong reduction in fertility
At1g02450	NIMIN1	NPR1/NIM1-interacting protein	Plant Cell, 17, 1279-1291, 2005	hyperactivation of PR-1 gene expression after SA treatment b
At1g02910	LPA1	a chloroplast protein that contains tv	Plant Cell, 18, 955-969, 2006	high chlorophyll fluorescence phenotype
At1g03000	PEX5	encodes an apparent ATPase similar	PNAS, 101, 1785-1791, 2004	resistant to the inhibitory effects of IBA on root elongation an
At1g03160	FZL	a new plant-specific member of the	PNAS, 103, 6759-6764, 2006	structures. fzl knockout mutants have abnormalities in chloro
At1g03310	ISA2	multimeric isoamylase	Plant J., 41, 815-830, 2005	Starch content is reduced
At1g03475	LIN2	coproporphyrinogen III oxidase	Plant J., 27, 89-99, 2001	Lesion mimic mutant. The lin2 mutant develops lesions on it
At1g04020	BARD1	BARD1, breast cancer associated	EMBO J., 25, 4326-4337, 2006	when challenged with the DNA crosslinking agent
At1g04120	MRP5	ABC Transporter; Putative Ion	Plant Physiol., 134, 528-538, 2004	Decreased root growth; Increased lateral root formation
At1g04640	EMB1687	Mitochondrial Lipoyltransferase	Plant Physiol., 1351, 1206-1220, 2004	embryo lethality
At1g05470	CVP2	inositol polyphosphate 5' phosphatas	Plant Cell, 16, 1263-1275, 2004	an increase in free vein endings and a resulting open vein ne
At1g05630	At5PTase13	inositol polyphosphate 5-phosphatas	Plant Physiol., 139, 1677-1691, 2004	At5PTase13 Deficiency Results in Abnormal Cotyledon Vein C
At1g06300	ACX3	acyl-CoA oxidase	Plant J., 41, 859-874, 2005	decreased sensitivity to the inhibitory effect of IBA on root eli
At1g06520	AGPAT1	Membrane-bound glycerol-3-phosphi	Plant Cell, 15, 1872-1887, 2003	atgpat1 Mutants Have Severely Reduced Male Fertility
At1g06950	Tic110	A multisubunit translocan of the inn	Plant J., 41, 412-428, 2005	embryo lethality
At1g07890	APX1	cytosolic ascorbate peroxidase	Plant J., 34, 187-203, 2003	Knockout-Apx1 plants were characterized by suppressed grow
At1g08090	NRT2.1	putative high-affinity nitrate transpor	PNAS, 102, 13693-13698, 2005	Impaired in nitrate uptake; When the three nrt2.1 mutants v
At1g08260	TIL1	Catalytic Subunit of DNA Pol-epsilon	Plant Cell, 17, 3362-3377, 2005	Embryo defective, globular
At1g08430	ALMT1	a homolog of the wheat Al-activated	PNAS, 103, 9738-9743, 2006	when Al3+ was introduced into medium, the MT was much r
At1g08510	FATB	Acyl-Acyl CP Thioesterase	Plant Cell, 15, 1020-1033, 2003	Essential for Normal Seedling Growth
At1g08810	MYB60	MYB	Curr Biol., 14, 1739-1746, 2004	A null mutation in AtMYB60 results in the constitutive reduct
At1g08840	EMB2411	Helicase/Nuclease (Dna2)	Plant Physiol., 1351, 1206-1220, 2004	embryo lethality
At1g10270	GRP23	a pentatricopeptide repeat (PPR) prc	Plant Cell, 18, 815-830, 2006	the arrest of early embryo development
At1g10470	ARR4	Type-A Arabidopsis response regulat	Plant Cell, 16, 658-671, 2004	arr4 (reduced levels of the transcripts) and arr5 displayed sui
At1g10510	EMB2004	LRR Protein: Similar to Human CARI	Plant Physiol., 1351, 1206-1220, 2004	embryo lethality
At1g10860	SAR3	similarity to human NUP96	Plant Cell, 18, 1590-1603, 2006	(Suppressors of the arr1 Mutant) The primary root is shorter t
At1g10930	RecQ14A	RecQ (ATP-dependent 3' to 5' DNA I	Plant J., 43, 789-798, 2005	hypersensitive to UV light and MMS, and more resistant to m
At1g11680	CYP51A2	obtusifoliiol 14-alpha demethylase	Plant Physiol., 138, 2033-2047, 2004	stunted hypocotyls, short roots, reduced cell elongation, and
At1g11720	AtSS3	starch synthase (SS) III	Plant Physiol., 138, 663-674, 2005	No obvious differences between mutant and wild type were c

Figure 3 Gene list describing the mutant phenotypes in Arabidopsis (part of the list).

for integrating that data and entering it in databases. We also look forward to providing thorough phenotypic data that will not only be useful in plant-related functional genomics, but that will also elucidate new gene-to-gene relationships and networks.

Extracting mutant phenotype information for an *Arabidopsis* gene encyclopedia

Our objective is to build a gene encyclopedia for the *Arabidopsis* genome/phenome by recording the phenotype for each gene mutants. In the previous section, we categorized the measurement parameters for obtaining phenotypic data using mutant resources. Additionally, mutant phenotypes have already been published in the literature for many of these genes. Including this published data, the groundwork has now been laid for generating a comprehensive mutant phenotype database. For reference, a mutant phenotype list has been published by Dr. D.W. Meinke [12]. We have combined this list with recent information from the literature, and are extracting phenotypic information to record for single genetic variations (Fig. 3). To date, mutant phenotypes have already been collected for approximately 1,700 *Arabidopsis* genes. In the future we plan to continue collecting phenotype information, both by the use of mutant resources for phenotype analysis and also by continuing to extract relevant data from the literature.

BIBLIOGRAPHY

1. Giaever, G. *et al.* Functional profiling of the *Saccharomyces cerevisiae* genome. *Nature* **418**, 387–391 (2002).
2. Kamath, R.S. *et al.* Systematic functional analysis of the *Caenorhabditis elegans* genome using RNAi. *Nature* **421**, 231–237 (2003).
3. Boutros, M. *et al.* Genome-wide RNAi analysis of growth and viability in *Drosophila* cells. *Science* **303**, 832–835 (2004).
4. The Multinational Arabidopsis Steering Committee (MASC). The Multinational Coordinated *Arabidopsis thaliana* Functional Genomics Project. Annual Report 2007.
5. Alonso, J.M. *et al.* Genome-wide insertional mutagenesis of *Arabidopsis thaliana*. *Science* **301**, 653–657 (2003).
6. Fedoroff, N.V., Smith, D.L. A versatile system for detecting transposition in *Arabidopsis*. *Plant J.* **3**, 273–289 (1993).
7. Ito T. *et al.* A new resource of locally transposed Dissociation elements for screening gene-knockout lines *in silico* on the *Arabidopsis* genome. *Plant Physiol.* **129**, 1695–1699 (2002).
8. Kuromori, T. *et al.* A collection of 11 800 single-copy *Ds* transposon insertion lines in *Arabidopsis*. *Plant J.* **37**, 897–905 (2004).
9. Ito, T. *et al.* A resource of 5814 *Dissociation* transposon-tagged and sequence-indexed lines of *Arabidopsis* transposed from start loci on chromosome 5. *Plant Cell Physiol.* **46**, 1149–1153 (2005).
10. Sakurai, T. *et al.* RARGE: a large-scale database of RIKEN *Arabidopsis* resources ranging from transcriptome to phenome. *Nucleic Acids Res.* **33**, D647–650 (2005).
11. Kuromori, T. *et al.* A trial of phenome analysis using 4000 *Ds*-insertional mutants in gene-coding regions of *Arabidopsis*. *Plant J.* **47**, 640–651 (2006).
12. Meinke, D.W. *et al.* A sequence-based map of *Arabidopsis* genes with mutant phenotypes. *Plant Physiol.* **131**, 409–418 (2003).

Mutational Analysis to Dissect Oxidative and Abiotic Stress in *Arabidopsis thaliana*

T Gechev^{1,2,*}, M A Ferwerda², N Mehterov¹, M K Qureshi², I Denev¹, C Laloi³, V Toneva¹, V Radeva¹, I Minkov & J Hille²

Abstract

A forward genetics approach was used to identify mutants more tolerant to oxidative stress. Chemically and T-DNA-mutagenized collections of *Arabidopsis thaliana* mutant lines were screened for survivors under conditions that trigger oxidative stress-induced programmed cell death (PCD). The fungal AAL-toxin triggers PCD through perturbations of sphingolipid metabolism in AAL-toxin-sensitive plants. While *Arabidopsis* is relatively insensitive to the toxin, the *loh2* mutant is sensitive to AAL-toxin due to knockout of a gene involved in sphingolipid metabolism. EMS mutagenesis of *loh2* resulted in second-site mutants that are more tolerant than *loh2* to the toxin. Nine of these mutants, named *atr* (AAL-toxin-resistant), were characterized towards their response to oxidative stress-induced cell death. Either application of the catalase inhibitor aminotriazole, leading to H₂O₂ accumulation was used, or paraquat, leading to superoxide radicals generation. Some mutants were more tolerant to aminotriazole, paraquat, or both herbicides. In another approach, T-DNA mutagenized wild type seeds were germinated on plant growth media supplemented with aminotriazole and one survivor was recovered. *Atr1*, *atr7* and *atr9*, with tolerance to both aminotriazole and paraquat, were studied in more details. They showed tolerance to paraquat at seedling stage as well as at rosette leaf stage. *Atr1* was subjected to microarray analyses at seedling stage under conditions that trigger cell death in *loh2* and no visible damage in *atr1*. While most of the genes showed similar expression pattern in both mutants, some genes were specifically regulated in *loh2* or *atr1*. These specifically regulated genes are potential targets for further functional studies. Downregulation of genes related to cell wall extension and cell growth in both mutants is consistent with the observed AT-induced growth inhibition in both mutants. It indicates that AT-induced oxidative stress influences two different processes: growth inhibition, observed in both mutants, and cell death, apparent only in *loh2*.

Introduction

Many unfavorable environmental factors, including drought, salinity, extreme temperatures and pollutants, result in rapid and sustained elevation of endogenous levels of reactive oxygen species (ROS), situation referred to as oxidative stress. In most cases, oxidative stress occurs as a result of both increased production and hampered detoxification of ROS. ROS, including hydrogen peroxide (H₂O₂), superoxide radicals (O₂⁻), and singlet oxygen (¹O₂), are not only toxic by-products of metabolism but also important modulators of a number of plant developmental processes, stress responses and programmed cell death (PCD) [1,2]. Examples of ROS-modulated developmental processes include embryo development, root hair growth, nucellar degeneration, maturation

of tracheal elements and epidermal trichomes, formation of lace leaf shape, and leaf senescence [1]. Many of these processes are also associated with ROS-dependent PCD. ROS-induced PCD is also an important component of the hypersensitive response, a defence reaction in which plant cells in and around the site of pathogen infection die in order to physically restrict the spread of the pathogen [3]. While in the above examples cell death is beneficial and/or essential for plant development and survival, some necrotrophic pathogens can secrete toxins that cause cell death in healthy tissues so that the pathogens can feed on the dead tissues [4].

Biological effects of ROS signalling depend on several factors, including chemical identity of ROS, sites of ROS production, amounts and duration of the elevated ROS levels, and interaction with other signalling molecules like plant hormones, nitric oxide, and lipid messengers [1]. Signalling properties have been reported for hydrogen peroxide, superoxide radicals, singlet oxygen, and even for the most destructive and short-lived hydroxyl radicals [1]. In general, low doses of ROS may induce protective mechanisms resulting in stress acclimation, while higher doses of ROS can initiate PCD.

ROS are metabolized by the antioxidant system of the cell, comprised of antioxidant molecules and enzymes [5]. Catalase is the main H₂O₂-detoxifying enzyme, serving as a cellular sink for hydrogen peroxide, while superoxide dismutase is the only plant enzyme metabolizing superoxide radicals [1]. Important antioxidant enzymes are also ascorbate peroxidases, glutathione reductases, glutathione-S-transferases and glutathione peroxidases, monodehydroascorbate and dehydroascorbate reductases, peroxiredoxins, and others [1,5]. Reduction of catalase activity by gene silencing or by catalase inhibitor aminotriazole (AT) leads to increased endogenous H₂O₂ levels, oxidative stress and eventual cell death [6,7]. H₂O₂-dependent cell death is a programmed process, associated with specific alterations in gene expression, and can be compromised by increased CO₂ concentration in the air [6,8,9].

The fungal AAL-toxin triggers cell death through perturbations of sphingolipid metabolism in AAL-toxin-sensitive tomato [10]. The toxin inhibits ceramide synthase, a key enzyme in sphingolipid synthesis, which leads to accumulation of precursors and depletion of complex sphingolipids. Tomato plants sensitive to the AAL-toxin have a mutation in the *Asc* gene that is most likely a component of the ceramide synthase [11]. The *Arabidopsis thaliana loh2* mutant is more sensitive to the AAL-toxin than the wild type due to the knockout of a gene homologous to the tomato *Asc* gene [4]. Microarray analyses of AAL-toxin-induced cell death in *loh2* revealed induction of hydrogen peroxide-responsive genes and genes that are involved in the oxidative burst at early time points preceding visible cell death symptoms [4]. This indication of oxidative burst in AAL-toxin-treated plants was in agreement with previous studies demonstrating accumulation of reactive oxygen species in *Arabidopsis* plants treated with fumonisin B1 (FB1), an AAL-toxin analogue [12]. Moreover, a recently identified FB1-resistant mutant compromised in serine palmitoyl transferase, a key enzyme of *de novo* sphingolipid synthesis, failed to generate ROS and to initiate cell death upon FB1 treat-

¹ Plovdiv University, Department of Plant Physiology and Plant Molecular Biology, 24 Tsar Assen str., Plovdiv 4000, Bulgaria

² University of Groningen, Department Molecular Biology of Plants, Researchschool GBB, Kercklaan 30, Haren 9751 NN, The Netherlands

³ Institute of Plant Sciences, ETH Zurich, Universitätsstrasse 2, CH-8092 Zurich, Switzerland

* Corresponding author. E-mail: tsangech@pu.acad.bg

ment [13]. This paper describes a genetic approach carried out to isolate mutants more tolerant to oxidative stress and their characterization in respect to several types of reactive oxygen species-induced cell death.

Materials and Methods

Plant material, growth conditions and isolation of mutants

Forty thousand seeds from *Arabidopsis thaliana loh2* mutant, described earlier [4], were mutagenized with 0.1 - 0.3% ethane methyl sulfonate for eight hours. After extensive washing, the mutagenized seeds were planted on soil in pools and grown under standard greenhouse conditions (14 h light/10h dark period, photosynthetic photon flux density 400 $\mu\text{mol. m}^{-2} \cdot \text{s}^{-1}$, 22°C and relative humidity 70%). Screening for resistance to AAL-toxin was done by plating the self-pollinated progeny seeds from M_1 plants on growth media containing 40 nM of AAL-toxin and grown in a climate room under the following conditions: 60 $\mu\text{mol. m}^{-2} \cdot \text{s}^{-1}$, 22°C. AAL-toxin-resistant survivors were transferred to the greenhouse and seeds collected for further analysis. Screening for tolerance to AT was done by placing 8600 M_3 T-DNA activation tagged mutant lines obtained from the Ohio Arabidopsis Stock Center (CS21995) on 9 μM AT and one survivor isolated 10 days after germination.

DNA isolation and TAIL PCR, microarrays and bioinformatics analysis

DNA was isolated with *DNasy* plant mini kit (Qiagen) according to the instructions of the manufacturer. TAIL-PCR was performed following the original protocol of [14,15] by using of 3 specific nested primers (SP1, SP2 and SP3: SP1 = TCCTGCTGAGCCTCGACATGTTGTC, S P 2 = T C G A C G T G T C T A C A T T C A C G T C C A , SP3=CCGTCGTATTATAGGCGAAAGC) and three arbitrary degenerated primers (AD1, AD2 and AD3: AD1=NTCGASTWTSWGTT, AD2= NGTCGASWGANAWGAA, AD3=WGTGNAGWANCANAGA). Microarrays and bioinformatics analysis has been previously described [16].

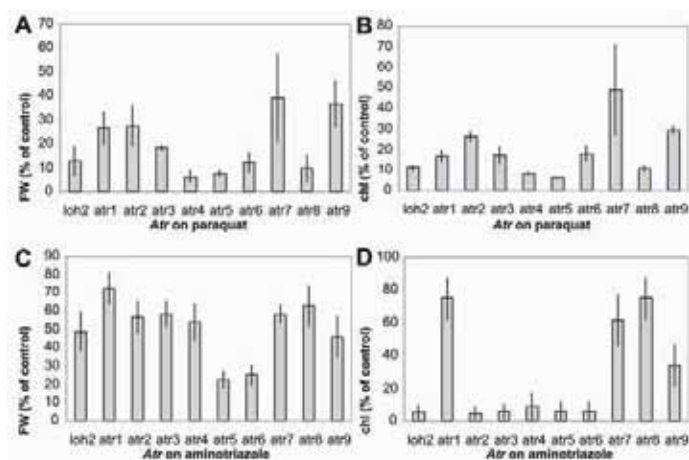

Figure 1 *Atr* mutants and their tolerance to reactive oxygen species-induced cell death. Seeds of nine *atr* mutants initially identified as more tolerant to AAL-toxin were plated on Murashige and Skoog (MS) media supplemented either with 0.5 μM paraquat (A, B) or with 7 μM aminotriazole (C, D) in order to assess their tolerance to cell death induced by superoxide radicals or hydrogen peroxide, respectively. Data represents the loss of fresh weight (FW) or chlorophyll (chl) of *atr* mutants grown on media supplemented with paraquat or aminotriazole and compared with *atr* mutants grown without paraquat and aminotriazole (controls). Samples for the measurements were collected one week after germination. Data are means of three measurements \pm SD.

Evaluation of tolerance to oxidative stress and cell death assessment

Assessment for tolerance to ROS-induced programmed cell death was done by plating seeds from *loh2* and *atr* mutants on media containing

either 7 μM AT or 0.5 μM paraquat and measuring the relative loss of fresh weight, chlorophyll, and visible cell death one week after germination. Chlorophyll content was measured photometrically as previously described [17]. In addition, plants were grown for four weeks to rosette leaf stage and sprayed with 15 μM paraquat. Visible damage, chlorophyll content and trypan blue staining for detection of dead cells was employed to evaluate the tolerance to paraquat-induced oxidative stress.

Results and Discussion

Isolation of mutants with enhanced tolerance to oxidative stress

Two approaches have been used to isolate mutants with enhanced tolerance to ROS-induced cell death. In the first approach, fungal AAL-toxin was used as an inducer of PCD and screening agent. Previous studies demonstrated that AAL-toxin leads to accumulation of H_2O_2 , followed by transcriptional reprogramming and programmed cell death [4]. Moreover, comparative transcriptional analysis revealed a very similar expression pattern between AAL-toxin-treated plants and plants compromised in catalase activity [18]. The *loh2* mutant of *Arabidopsis* is sensitive to AAL-toxin due to knockout of a gene involved in sphingolipid metabolism [4]. Forty thousand seeds from *loh2* were chemically mutagenized with ethane methyl sulfonate, germinated on soil, self-pollinated and the resulting progeny plated on AAL-toxin-containing media in order to isolate mutants that are more tolerant to AAL-toxin than the original *loh2* background. While the wild type *Arabidopsis* is resistant to 200 nM AAL-toxin, the *loh2* mutant develops cell death symptoms at 20 nM AAL-toxin already and 40 nM of the toxin leads to lethality. Thirty independent survivors were isolated using a concentration of 40 nM AAL-toxin as a screening threshold. Nine of these mutants, named *atr* (AAL-toxin resistant), were selected for further analysis (Fig. 1). Genetic studies by crossing *atr* with the wild type and studying the progeny indicated that *atr* mutants were recessive (data not shown).

In the second approach, catalase inhibitor AT was used as an inducer of oxidative stress and screening agent. Previous results showed that AT added in plant growth media at concentrations of 7 μM to 9 μM , depending on the plant background, can inhibit catalase and lead to oxidative stress-dependent cell death in wild type plants [7]. A T-DNA activation-tagged mutant collection with 8,600 lines obtained from the Ohio Arabidopsis Stock Center (CS21995) was screened on media with AT. One mutant surviving the lethal AT concentrations was isolated. TAIL-PCR analysis has identified flanking DNA sequences around the T-DNA insert and revealed the position of the T-DNA on chromosome 2, between gene loci At2g27270.1 and At2g27280.1. Molecular analysis indicated presence of a single T-DNA insert.

Characterization of *atr* mutants for tolerance to ROS-inducing herbicides and expression analysis during AT-induced oxidative stress

Earlier studies indicated that the AAL-toxin causes induction of ROS-associated genes and H_2O_2 accumulation that precedes the cell death [4]. To investigate the link between AAL-toxin and oxidative stress, the nine *atr* mutants were also tested for tolerance to PCD induced by ROS-generating herbicides (Fig. 1). While AT leads to H_2O_2 accumulation, paraquat causes superoxide-dependent cell death [19]. Application of either AT or paraquat in plant growth media caused reduction in growth as measured by fresh weight loss (Fig. 1), reduction in total chlorophyll content (Fig. 1) and eventually death of *loh2* (Fig. 2). Some of the *atr* mutants were more tolerant to both paraquat and AT than *loh2*, as estimated by the lack of cell death, smaller decrease in fresh weight and more chlorophyll. Other mutants, however, were more tolerant either to AT or to paraquat, indicating the complexity of the cell death process. It could be that mutants more tolerant to both cell death stimuli are downstream of the convergence point of superoxide and hydrogen

peroxide-triggered signaling cascades. Three of the mutants with tolerance to both AT and paraquat, *atr1*, *atr7* and *atr9* were selected for further analysis. Interestingly, all three mutants grow slowly than *loh2* on normal media, which can be a 'trade-off' for their enhanced stress tolerance. In presence of AT or paraquat they show no visible damage while wild type plants die rapidly (Fig. 2). The tolerance of *atr1*, *atr7* and *atr9* towards paraquat was evident also at rosette leaf stage. Spraying with paraquat resulted in much less damage on the leaves of the mutants compared with the *loh2* control (Fig. 3). Preliminary results indicate that two of the oxidative stress-tolerant mutants are also more tolerant to chilling stress. Evaluation of other abiotic stress factors, currently going on, could further establish the link between oxidative and abiotic stress.

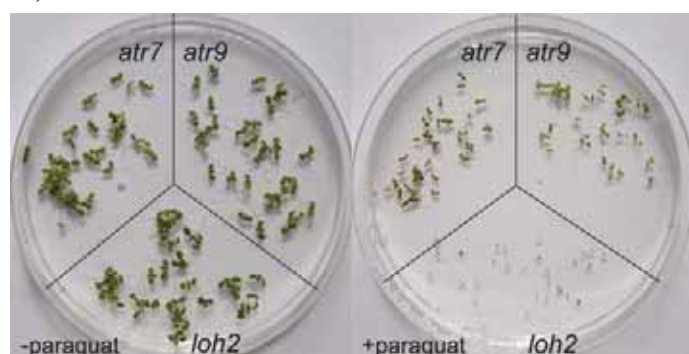

Figure 2 Oxidative stress-tolerant mutants *atr7* and *atr9* show enhanced tolerance to paraquat at seedlings growth stage. Oxidative stress-tolerant mutants *atr7* and *atr9*, and their parental line *loh2* were germinated without or with presence of 0.7 μ M paraquat. Pictures were taken 5 days after germination.



Figure 3 *Atr1*, *atr7* and *atr9* show enhanced tolerance to superoxide radical-generating herbicide paraquat at rosette leaf stage. Four-week-old *atr1*, *atr7* and *atr9* and their respective control *loh2* were sprayed with 15 μ M paraquat and pictures taken three days after treatment.

Microarray analysis of *atr1* and *loh2* on media with AT under conditions that trigger cell death in *loh2* and no visible damage in *atr1* at seedlings growth stage revealed that the majority of the genes are similarly induced or repressed in both mutants with only small sets of genes specifically regulated in *atr1* or *loh2* [16]. Most of the genes strongly

Table 1. AT-induced gene expression in *loh2* and *atr1*

Description	Gene Locus	<i>loh2</i>	<i>atr1</i>
high-affinity nitrate transporter NRT2	AT1G08090.1	8.21	83.81
putative isocitrate lyase	AT3G21720.1	9.81	2.64
similar to F-box protein family	AT2G16365.1	9.81	2.00
heat shock protein 17	AT3G46230.1	12.83	1.46
heat shock protein 17.6A	AT5G12030.1	8.65	0.89
extensin-like protein	AT5G46890.1	-27.96	-23.90
putative proline-rich protein	AT2G33790.1	-27.52	-30.62
extA (emb CAA47807.1)	AT5G46900.1	-21.92	-21.00
unknown protein	AT1G19900.1	-13.90	-9.89
cytochrome p450, putative	AT2G25160.1	-10.15	-4.22
glutathione transferase, putative	AT1G49860.1	3.51	4.01
glutathione transferase, putative	AT1G53680.1	-6.28	-6.39
glutathione transferase, putative	AT3G62760.1	-2.66	-2.41
glutathione transferase, putative	AT1G17190.1	-2.05	-2.51
thioredoxin, putative	AT1G45145.1	-2.98	-1.97
putative glutaredoxin	AT2G30540.1	2.12	2.10
glutaredoxin	AT4G15690.1	-0.96	-3.82
glutaredoxin homolog	AT4G15700.1	-1.06	-3.28
glutaredoxin	AT4G15670.1	-1.07	-3.17
glutaredoxin	AT4G15680.1	-0.96	-2.95
glutaredoxin	AT4G15660.1	-1.09	-2.66
type 2 peroxiredoxin, putative	AT1G65970.1	-2.91	-2.88
peroxiredoxin, putative	AT1G60740.1	-2.75	-2.33
copper/zinc superoxide dismutase (CSD2)	AT2G28190.1	-1.22	-2.17
monodehydroascorbate reductase, putative	AT3G09940.1	-4.88	-3.50
dehydroascorbate reductase, putative	AT5G36270.1	-2.94	-2.50
peroxidase, putative	AT1G24110.1	2.44	2.24
peroxidase family	AT4G16270.1	2.13	2.27
peroxidase, putative	AT1G05240.1	-11.85	-8.06
peroxidase, putative	AT4G26010.1	-11.12	-15.46
peroxidase, putative	AT1G34510.1	-9.94	-7.99
peroxidase, putative	AT5G67400.1	-9.11	-9.28
peroxidase, putative	AT2G39040.1	-8.26	-7.03
cationic peroxidase, putative	AT1G30870.1	-6.44	-6.64
peroxidase, putative	AT3G01190.1	-5.34	-3.20
peroxidase, putative	AT2G18980.1	-4.55	-3.98
peroxidase, putative	AT5G17820.1	-4.42	-3.23
peroxidase, putative	AT4G30170.1	-3.89	-3.48
peroxidase, putative	AT3G49960.1	-3.49	-4.25
peroxidase, putative	AT5G22410.1	-3.47	-5.35
peroxidase, putative	AT5G64100.1	-3.30	-2.64
peroxidase, putative	AT5G15180.1	-2.96	-3.48
peroxidase, putative	AT1G34330.1	-2.96	-2.25
peroxidase, putative	AT5G42180.1	-2.91	-2.29
anionic peroxidase, putative	AT1G14540.1	-2.49	-2.79
cationic peroxidase family	AT5G24070.1	-2.17	-2.14
peroxidase, putative	AT1G49570.1	-4.73	-1.73
peroxidase, putative	AT5G19890.1	-2.98	-1.74
peroxidase, putative	AT1G05260.1	-2.33	-1.39
anionic peroxidase, putative	AT1G14550.1	-1.23	-3.78

Arabidopsis thaliana loh2 and *atr1* mutants were grown on media without or with 7 μ M AT, and samples for microarray experiments collected two days before cell death symptoms in *loh2*. The first 10 genes listed are the most induced or repressed genes; the other genes in the list encode for antioxidant enzymes and are regulated at least two-fold. Data are means of two biological replicates. Positive values indicate upregulated genes while negative values indicate downregulated genes.

downregulated in both mutants were related to cell wall extension and cell growth, in line with the similar AT-induced growth inhibition in both mutants. This indicates that two different pathways, one for modulating growth inhibition and second triggering cell death, are associated with AT-induced oxidative stress.

In this paper, we focused on the expression pattern of the antioxidant enzymes. Genes with regulation more than two-fold on average from the two biological repetitions are presented in Table 1. Majority of the antioxidant enzymes were repressed in both *loh2* and *atr1*. For example, 24 genes encoding for guaiacol peroxidases were regulated; 18 of them were repressed in both mutants, three were repressed only in *loh2*, one repressed only in *atr1*, and two induced in both mutants. One monodehydroascorbate reductase, one dehydroascorbate reductase, and two peroxiredoxins were regulated – all of them repressed in both mutants. 3 from four regulated glutathione transferases were repressed and one induced in both mutants. An exception from this general trend were glutaredoxins, as five out of six regulated genes were repressed only in *atr1*. The downregulation of majority of the antioxidant enzymes, although with unclear biological functions, may be related to the oxidative stress-induced repression of growth in both mutants.

Conclusion

Two approaches for isolation of mutants with enhanced tolerance to oxidative stress have been demonstrated. The approaches, based on the fungal AAL-toxin and on the catalase inhibitor AT, are suitable for screening chemical as well as T-DNA mutant lines. Some of the isolated mutants show enhanced tolerance to a number of factors causing oxidative stress-induced cell death, while other mutants show enhanced tolerance to limited or only one cell death trigger, indicating the complexity of the responses. AT causes two different effects: growth inhibition, evident in both the sensitive parental *loh2* line and the cell death-tolerant *atr* mutants, and cell death, evident only in the parental line. This notion is further supported by microarray analysis of *loh2* and *atr1*, revealing AT-dependent downregulation of growth associated genes in both *loh2* and *atr1*. The transcriptome analysis revealed also genes specifically regulated only in *loh2* or *atr1*. These genes are potential targets for further functional studies aimed at elucidating their role in the oxidative stress tolerance and cell death.

ACKNOWLEDGEMENTS

This work was supported in part by grants from the IAEA (Contract 13220), the Swiss NSF (SCOPES programme, Project IB73A0-110774), and the NSF of Bulgaria (Projects G5/UB3).

BIBLIOGRAPHY

- Gechev, T.S., Van Breusegem, F., Stone, J.M., Denev, I., Laloi, C. Reactive oxygen species as signals that modulate plant stress responses and programmed cell death. *BioEssays* **28**, 1091-1101 (2006).
- Gechev, T.S., Hille, J. Hydrogen peroxide as a signal controlling plant programmed cell death. *J. Cell Biol.* **168**, 17-20 (2005).
- Dangl, J.L., Jones, J.D.G. Plant pathogens and integrated defence responses to infection. *Nature* **411**, 826-833 (2001).
- Gechev, T.S., Gadjev, I.Z., Hille, J. An extensive microarray analysis of AAL-toxin-induced cell death in *Arabidopsis thaliana* brings new insights into the complexity of programmed cell death in plants. *Cell. Mol. Life Sci.* **61**, 1185-1197 (2004).
- Mittler, R., Vanderauwera, S., Gollery, M., Van Breusegem, F. Reactive oxygen gene network of plants. *Trends Plant Sci.* **9**, 490-498 (2004).
- Vanderauwera, S., Zimmermann, P., Rombauts, S., Vandenabeele, S., Langebartels, C., Gruijssem, W., Inzé, D., Van Breusegem, F. Genome-wide analysis of hydrogen peroxide-regulated gene expression in *Arabidopsis* reveals a high light-induced transcriptional cluster involved in anthocyanin biosynthesis. *Plant Phys.* **139**, 806-821 (2005).
- Gechev, T.S., Minkov, I.N., Hille, J. Hydrogen peroxide-induced cell death in *Arabidopsis*: Transcriptional and mutant analysis reveals a role of an oxoglutarate-dependent dioxygenase gene in the cell death process. *IUBMB Life* **57**, 181-188 (2005).
- Vandenabeele, S., Vanderauwera, S., Vuylsteke, M., Rombauts, S., Langebartels, C., Seidlitz, H.K., Zabeau, M., Van Montagu, M., Inzé, D., Van Breusegem, F. Catalase deficiency drastically affects gene expression induced by high light in *Arabidopsis thaliana*. *Plant J.* **39**, (2004) 45-58.
- Vandenabeele, S., Van Der Kelen, K., Dat, J., Gadjev, I., Boonefaes, T., Morsa, S., Rottiers, P., Slooten, L., Van Montagu, M., Zabeau, M., Inzé, D., Van Breusegem, F. A comprehensive analysis of hydrogen peroxide-induced gene expression in tobacco. *Proc. Natl. Acad. Sci. USA* **100**, 16113-16118 (2003).
- Spassieva, S.D., Markham, J.E., Hille, J. The plant disease resistance gene Asc-1 prevents disruption of sphingolipid metabolism during AAL-toxin-induced programmed cell death. *Plant J.* **32**, 561-572 (2002).
- Brandwagt, B.F., Mesbah, L.A., Takken, F.L.W., Laurent, P.L., Kneppers, T.J.A., Hille, J., Nijkamp, H.J.J. A longevity assurance gene homolog of tomato mediates resistance to *Alternaria alternata* f. sp. *lycopersici* toxins and fumonisin B1. *Proc. Natl. Acad. Sci. USA* **97**, 4961-4966 (2000).
- Asai, T., Stone, J.M., Heard, J.E., Kovtun, Y., Yorgey, P., Sheen, J., Ausubel, F.M. Fumonisin B1-induced cell death in *Arabidopsis* protoplasts requires jasmonate-, ethylene-, and salicylate-dependent signaling pathways. *Plant Cell* **12**, 1823-1835 (2000).
- Shi, L.H., Bielawski, J., Mu, J.Y., Dong, H.L., Teng, C., Zhang, J., Yang, X.H., Tomishige, N., Hanada, K., Hannun, Y.A., Zuo, J.R. Involvement of sphingoid bases in mediating reactive oxygen intermediate production and programmed cell death in *Arabidopsis*. *Cell Res.* **17**, 1030-1040 (2007).
- Liu, Y.G., Mitsukawa, N., Oosumi, T., Whittier, R.F. Efficient isolation and mapping of *Arabidopsis thaliana* T-DNA insert junctions by thermal asymmetric interlaced PCR. *Plant J.* **8**, 457-463 (1995).
- Liu, Y.G., Whittier, R.F. Thermal asymmetric interlaced PCR - automatable amplification and sequencing of insert end fragments from P1 and Yac clones for chromosome walking. *Genomics* **25**, 674-681 (1995).
- Gechev, T., Ferwerda, M., Mehterov, N., Laloi, C., Qureshi, K., Hille, J. *Arabidopsis* AAL-toxin-resistant mutant *atr1* shows enhanced tolerance to programmed cell death induced by reactive oxygen species. *Biochem. Biophys. Res. Com.* **375**, 539-544 (2008).
- Gechev, T., Willekens, H., Van Montagu, M., Inzé, D., Van Camp, W., Toneva, V., Minkov, I. Different responses of tobacco antioxidant enzymes to light and chilling stress. *J. Plant Phys.* **160**, 509-515 (2003).
- Gadjev, I., Vanderauwera, S., Gechev, T., Laloi, C., Minkov, I., Shulaev, V., Apel, K., Inzé, D., Mittler, R., Van Breusegem, F. Transcriptomic footprints disclose specificity of reactive oxygen species signaling in *Arabidopsis*. *Plant Phys.* **141**, 434-445 (2006).
- Vranova, E., Atichartpongkul, S., Villarreal, R., Van Montagu, M., Inzé, D., Van Camp, W. Comprehensive analysis of gene expression in *Nicotiana tabacum* leaves acclimated to oxidative stress. *Proc. Natl. Acad. Sci. USA* **99**, 10870-10875 (2002).

Development of Salinity-tolerant Rice Varieties Using Biotechnological and Nuclear Techniques

M C González^{1*}, N Pérez¹, E Cristo¹, M Rodríguez² & O Borrás²

Abstract

A breeding programme using biotechnological and nuclear techniques was developed in order to obtain salinity-tolerant rice varieties, using Amistad-82 and Jucarito-104 rice varieties as donors. This study included the increasing genetic variability by means of somaclonal variation and in vitro mutagenesis with proton radiations, the establishment of culture medium for callus formation and plant regeneration, as well as the establishment of feasible salt tenors for in vitro selection and the identification of morphological markers for the early selection of salinity-tolerant lines. The selection was carried out under field conditions for four years. A methodology was established to obtain salinity-tolerant rice varieties using biotechnological and nuclear techniques and it was possible to release two salinity tolerant rice varieties that are being used in rice production.

Keywords:

Rice - Salinity - Somaclonal Variation - Mutation Induction - Protons

Introduction

Soil salinity is one of the most dangerous problems in the world. In Cuba, the inadequate rainfall distribution together with long periods of drought, some salt-polluted aquifers, as well as man's misuse and mismanagement of land have multiplied saline areas up to 14% and the same amount is prone to become saline [1].

Rice (*Oryza sativa* L.) is one of the most important crops in the world. Rice is planted on about one tenth of the earth's arable land and it is the unique largest source of food energy to half of humanity [2, 3]. In Cuba, it is an essential cereal but its yielding is very low, taking into account that varieties are affected by several biotic and abiotic stresses, such as soil salinity and drought.

About 14% of the agricultural areas are affected by salinity in our country. Therefore, it is necessary to obtain salinity-tolerant rice varieties in order to increase production of this cereal in Cuba.

Commercial rice varieties are characterized by a high degree of genetic homogeneity [4]; however, a diverse genetic basis of breeding material would be advantageous when using genotypes resulting from induced mutations.

Biotechnological and nuclear techniques can be used along with traditional breeding methods in some breeding programmes. Rice mutation breeding could be considered especially successful to obtain new cultivars with good agronomic characteristics, as well as biotic stress resistance and/or abiotic stress tolerance, also to broaden crop genetic base [5].

A breeding programme using biotechnological and nuclear techniques was developed, in order to obtain salinity-tolerant rice varieties.

Materials and Methods

Culture medium

To get the best culture medium for callus formation and plant regeneration, mature seeds of Amistad-82 (A-82) and Jucarito-104 (J-104) rice varieties were grown on a Murashige and Skoog medium [6], supplemented with different concentrations of 2,4-D and BAP, 30g refine sugar and vitamins. Callus formation was evaluated. After 30 days, calluses were transferred to a fresh medium with kinetin and IAA for plant regeneration.

Saline concentration in the culture medium

Mature seeds of A-82 and J-104 varieties were cultured in the best medium supplemented with different commercial salt concentrations, in order to establish the optimal concentration for callus formation and plant regeneration under saline conditions.

Increased genetic variability

Mature seeds of Jucarito-104 (J-104) rice variety (11.5% moisture content) irradiated with 20Gy protons at the Phasotron facilities (DUBNA) as well as those of Amistad-82 were grown in vitro on a Murashige & Skoog medium supplemented with 2 mg.L⁻¹ 2,4-D, 2 mg.L⁻¹ BAP and 4g.L⁻¹ salt, in order to increase genetic variability. After 30 days, calluses were transferred to regenerated plant medium.

Such regenerated plants were planted under greenhouse conditions, and plant cycle, height, panicle number/plant, full grains/panicle as well as yield/plant were evaluated. A Multivariate Analysis was used to assess variability.

Selection

Seeds of each regenerated plant were sown in boxes containing inert substratum with saline water at an electrical conductivity of 8d.Sm⁻¹. After 15 days, root length and plant height of surviving plants were evaluated for an early selection. Plants selected were multiplied and sown in saline soil (4,000 to 16,000 ppm). Selection on saline soil was developed during four generations.

Plant cycle, number of tiller per plant, grain number per panicle, grain weight and yield were evaluated in the plants selected every selection cycle.

Results

Culture medium selected

The culture medium enabled to obtain a higher percentage of callus formation as well as more callus with buds and bud number per callus. In both varieties, the best combination was that containing 2 mg.L⁻¹ 2,4D and 2 mg.L BAP¹ (Table 1).

It should be pointed out that by combining 2,4D and BAP, bud regeneration started when transferred to lighting conditions using the same means employed for callus formation.

¹ National Institute of Agricultural Sciences (INCA), Cuba

² Center for Genetic Engineering and Biotechnology (CIGB), Cuba

* Corresponding author. E-mail: mcaridad@inca.edu.cu

When evaluating the effect of different salt concentrations in the callus formation and plant regeneration medium, a considerable decrement was observed with an increase of salt concentration in the culture medium as well as higher concentrations than 7 g.L⁻¹ affect the process of plant regeneration considerably in both varieties; thus the concentration of 4 g.L⁻¹ was selected (Table 2).

It can be observed that the variety J.104 is more susceptible to salinity than A-82, since plant regeneration is considerably affected with an increase of saline concentration in the culture medium. Considering the results, it was determined that a culture medium with 2 mg.L⁻¹ 2,4D, 2 mg.L⁻¹ BAP and 4 g.L⁻¹ salt should be used.

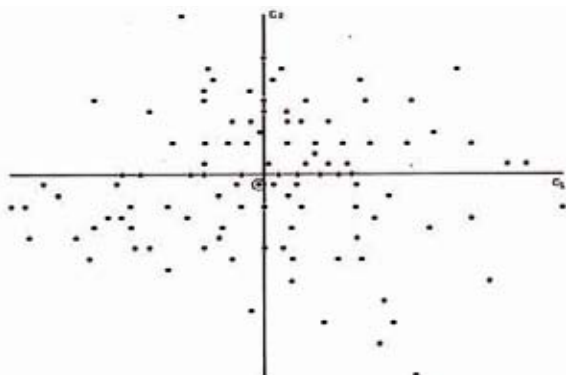

Figure 1 Space distribution of plants selected in vitro starting from Main Components Analysis using the characters: height, panicle number/plant, full grains/panicle and yield.

Table 1. Callus formation and plant regeneration of A-82 and J-104 rice varieties cultivated on a MS medium supplemented with different combinations of 2,4-D and BAP

Saline concentrations (g.L ⁻¹)		Callus formation (%)		Callus with shoots (%)		No. shoots/ callus	
2,4-D	BAP	A-82	J-104	A-82	J-104	A-82	J-104
1	-	100	100	1,0	2,0	1,0	1,0
2	-	100	100	2,0	-	1,0	-
3	-	100	100	1,0	-	1,0	-
1	1	99	100	28,1	12,0	4,5	3,2
1	2	100	98	22,0	10,3	9,0	2,8
1	3	100	100	41,0	20,5	13,4	6,2
2	1	100	99	2,5	2,0	1,0	1,0
2	2	100	100	58,3	49,2	16,6	12,3
2	3	100	100	21,5	6,5	8,5	3,4
3	1	99	100	1,5	-	1,0	-
3	2	100	100	2,5	1,0	3,2	1,0
3	3	100	100	14,8	1,0	2,5	1,0

Table 2. Callus formation and plant regeneration of A-82 and J-104 rice varieties cultivated on a MS medium supplemented with 2 mg.L⁻¹ 2,4-D and 2m.L⁻¹ BAP and different commercial salt concentrations.

Saline concentrations (g.L ⁻¹)	Callus formation (%)		Callus with shoots (%)		No. shoots/ callus	
	A-82	J-104	A-82	J-104	A-82	J-104
0	100	100	40,3	48,9	12,5	13,2
1	92	85	30,1	21,5	5,3	1,0
4	66	26	15,5	2,5	1,5	1,0
7	25	5	-	-	-	-
10	3	-	-	-	-	-
13	-	-	-	-	-	-
16	-	-	-	-	-	-

Table 3. Number of plants selected in each selection cycle

Conditions	Saline concentrations (ppm)	Selected genotypes
In vitro selection	4,000	125
Screening in saline solution (8 d.Sm ⁻¹)	7,500	68
Selection in field conditions	4,000-16,000	36
Selection in field condition	4,000-16,000	18
Selection in field condition	4,000-16,000	10
Yield trial	4,000-7,000	2

Table 4. Main differences of mutants and somaclones with its respective donors

Character	Donor	Somaclon	Donor	Mutant
	A-82	LP-7	J-104	GINES
Days to maturity	111/126	135/150	133/150	119/137
Weigh of 1,000 grains	28	30	31	33
Grain number per panicle	35-42	67-75	31-47	68-73
Disease resistance	Susceptible Steneotarsonemus Spinki	Resistant Steneotarsonemus Spinki	Susceptible Pyricularia grisea	Middle resistant Pyricularia grisea
Yield in saline conditions (5-7 dSm/m)	1,8 t/ha	3,4 t/ha	1,4 t/ha	3,3 t/ha

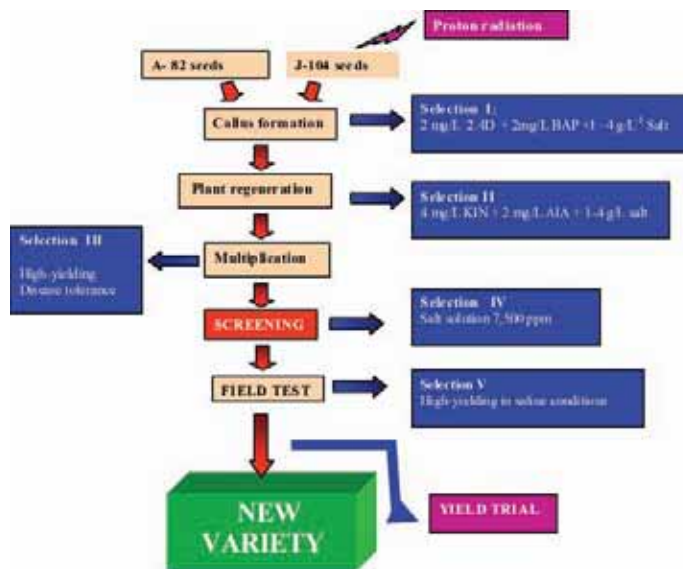

Figure 2 Methodology established for salinity breeding programme in rice using biotechnological and nuclear techniques.

Selection

The number of selected plants was diminished in each selection cycle (Table 3). Starting from the methodology employed, it could be recommended to register two new rice varieties for rice production, since they are salinity-tolerant, show good agronomic characteristics and also more tolerance to some diseases affecting the national rice production (Table 4).

Further research will give us insight to the feasibility of somaclonal variation and mutation induction with protons in rice genetic improvement, as well as to establish a methodology for obtaining salinity tolerant rice varieties using biotechnological and nuclear techniques (Fig. 2).

ACKNOWLEDGEMENTS

These results have been supported by the Project Cub/05/16 “Mutation breeding for tropical crop improvement” and the CRP 12989 “Identification and Pyramiding of Genes Associated with Salinity Tolerance in Rice Somaclones and Mutants,” as well as Eloy Padron and the Staff of the Phasotron facilities in DUBNA.

BIBLIOGRAPHY

1. National Programme to combat desertification and drought in the Republic of Cuba, (2003).
2. Eckardt, N.A. Sequencing the Rice Genome. *Plant Cell* **12**, 2011-2017 (2000).
3. Kurata, N., Yamazaki, Y. Oryzabase. An integrated biological and genome information database for rice. *Plant Physiology* **140**, 12-17 (2006).
4. Fuentes, J.L., Escobar, F., Alvarez, A., Gallego, G., Duque, M.C., Ferrer, M., Deus, J.E., Tohme, J.M. Analysis of genetic diversity in Cuban rice varieties using isozyme, RAP and AFLP markers. *Euphytica* **109**, 107-115 (1999).
5. Alvarez, A., Fuentes, J.L., Deus, J.E., Duque, M.C., Cornide, M.T. Genetic diversity analysis in rice mutants using isozyme and morphological markers. *Cultivos Tropicales* **21**, 39-44 (2000).
6. Murashige, T., Skoog, F.A. A revised medium for rapid growth and bioassays with tobacco tissue culture. *Physiol. Plant* **15**, 473-479 (1962).

Evaluation and Characterization of Mutant Cowpea Plants for Enhanced Abiotic Stress Tolerance

J A de Ronde*, M Spreeth, N Mayaba, W J van Rensburg & N Matole

Abstract

The objective of the project is to use the radiation-induced mutations in cowpea to improve cowpea varieties grown by resource-poor farmers in South Africa. The first aim of the project was to select mutant cowpea plants with improved levels of drought tolerance without alteration to the color of the testa or the growth form. It was demonstrated that it was possible to examine mutant lines at seedling stage in wooden boxes. Mature plants were screened in rain out shelters and physiological traits for drought stress were identified among the lines tested. Roots of mature plants were also assessed and variations observed could be correlated with drought tolerance. The data demonstrated that physiological methods can be used to screen mutants. The yield performance of some mutant lines proved to be outstanding under well-watered, as well as under drought stress conditions. The second aim was to further characterize the most promising mutant lines using molecular and physiological techniques. cDNA-Amplified Fragment Length Polymorphism showed differential gene expression at different time points of drought stress. The sequenced transcript derived fragments (TDF) showed high homology to expressed sequence tags of soybean, with a possible function in cell defense/resistance and most importantly, signal transduction. Reverse transcription PCR using a number of primers from published sequences, as well as from the TDF sequences, validated the differential gene expression obtained from the cDNA-AFLP display. The third aim was to evaluate selected mutants on station and at different communities. On station field trials were conducted at the ARC-VOPI's research farm under dry land as well as irrigation conditions for the last two seasons. The long term plan is to introgress the drought tolerance trait from the best mutant line into drought susceptible South African cultivars grown by resource-poor farmers.

Introduction

Vigna unguiculata (L.) Walp., commonly known as cowpea, is a grain legume that is grown mainly in Africa, Asia, and South America. Cowpea grain contains about 25% protein, making it extremely valuable where many people cannot afford animal protein foods [1]. Cowpea is a dual crop in Africa, where the nutritious tender leaves of the plant as well as the green pods are consumed [2]. As a drought-tolerant crop, cowpea is adapted to dry or arid environments where rainfall is low and erratic, soils less fertile and other crops habitually fail [3]. Another valuable characteristic is that cowpea fixes atmospheric nitrogen through its root nodules and can grow in poor soils with more than 85% sand, with less than 0.2% organic matter and low levels of phosphorus [4]. Several centers of domestication have been suggested for cowpea, such as Ethiopia, Central Africa, South Africa and West Africa, but the East and Southern Africa are considered as the primary region of diversity and West and Central Africa to be the secondary centers of diversity [5].

Drought is a major constraint to agricultural production in many developing countries. Direct and indirect economic losses in the agricultural sector due to drought are huge. Moreover, the recent climatic changes necessitate the need to develop crops more tolerant to drought and to reduce poverty in the developing world. Significant potential exists for the improvement of crop productivity by selecting plants that are better equipped to cope with drought stress. Cowpea is an extremely resilient crop that is well known for its ability to survive under conditions of water stress and it plays an important role in regions where drought is the factor most limiting to crop yield [6]. One way to combat drought is to develop crops of agricultural importance that are more tolerant to drought stress by combining plant physiology and biotechnological techniques. A better understanding of the physiology and genetics of cowpeas under drought could lead to the improvement of its drought tolerance and water use, in order to improve yield. A multidisciplinary approach was thus initiated over the past years at ARC-VOPI in collaboration with IAEA, to improve cowpea by inducing mutations for enhanced drought tolerance.

Materials and Methods

Various cowpea mutant lines were screened and compared with control lines received from International Institute of Tropical Agriculture (IITA) in Nigeria. These lines comprised of the control lines IT96D-602 (drought-tolerant) and TVu7778 (susceptible), as well as the parent line of the mutants, IT93K129-4. This line was selected for its color, growth form and yield. Various gamma irradiation dosages between 0 and 300Gy were applied (n=100 seed) to IT93K129-4 to obtain a high frequency of gene mutation and chromosomal alterations. A total of 17,000 cowpea seeds were consequently irradiated using the optimal irradiation dosage of 180Gy. Aberrations that were observed include leaf mutation and chlorophyll deficiencies.

The wooden box procedure of Singh [7] was used for the screening of mutant seedlings. The calorimetric method of Bates [8] was used to determine the proline concentrations of freeze dried leaves. Leaves were collected early in the morning to determine relative water content (RWC) [9]. The root systems of the plants were evaluated using the root architecture box technique developed by Singh [7].

The Restriction fragment length polymorphisms (RAPD) technique was performed according to the method of Fall [10] and the amplified fragment length polymorphism (AFLP) modification version of Vos [11] was used.

Results and Discussion

The first aim of the project was to improve the drought tolerance and yield of cowpea plants without alteration to the color of the testa or the growth form, to such an extent that it could be used in marginal areas where rainfall is either scarce or unreliable. M₁ seed of IT93K129-4 were planted in the field, after which 8 230 M₂ true to type plants, that had survived the irradiation process and yielded seed, were selected. M₂ seeds were planted in wooden boxes in a greenhouse for early drought selec-

Agricultural Research Council - Vegetable and Ornamental Plant Institute (ARC-VOPI), Private Bag X293, Pretoria 0001, South Africa

* Corresponding author. E-mail: kderonde@arc.agric.za

tion (891), as well as under a rain out shelter for late drought selection (1239). These lines were evaluated against IT96D-602 and TVu7778, and resulted in selection of 487 lines with higher levels of drought tolerance. Some of the mutant lines used a drought evasion method to survive, they produced seed before reaching the permanent wilting stage and although the plants did not recover after the stress period, viable seeds were produced, thus, ensuring the next generation. Other lines withstood the period of drought stress and were able to recover to such an extent that the plants were able to produce seed after being rewatered. Promising M_3 and M_4 lines were replanted in wooden boxes, in dry land trials in the field and under rain out shelters. Nine of the best performing lines were selected on the basis of yield in the field, 22 promising lines were identified in the rain out shelter trials and 36 in the wooden box trials [12].

The six best lines from all this screening methods were characterized by using physiological screening techniques conducted on drought-stressed greenhouse plants. The screening techniques included chlorophyll fluorescence, free proline, RWC and yield. After 12 days without water the plants started to react visibly to the drought stress condition. Some plants started to lose chlorophyll in their lower leaves, while others inclined their leaves away from the sun. The RWC of the stressed plants at this stage was between 80% and 90%. As the stress condition intensified the RWC dropped further and after 24 days without water the RWC of line Cp-m346 was as low as 65%, compared to the 75% of Cp-MA1 and IT96D-602. The more drought tolerant cowpea lines, Cp-m217 and IT96D-602, only started to produce proline in the latter part of the stress period, and at 24 days without water exhibited lower concentrations than the other lines tested [12].

The yield performance (number of seed) of the mutant lines Cp-m447, CpMA2 and Cp-m217 proved to be outstanding under well-watered conditions, as well as lines Cp-m447, Cp-m217 and Cp-m346 under drought-stress conditions. The plants were also evaluated according to the mean seed weight. Line IT93K129-4 produced the heaviest seed under well-watered conditions, followed by Cp-MA2, Cp-m447 and Cp-m164, and under drought conditions lines IT93K129-4, Cp-m447 and Cp-m164 produced the heaviest seed. The ideal plant for subsistence farmers will be the one that produces a moderate to good yield under all conditions like lines Cp-m447 and Cp-m217. The data demonstrated that Cp-m217 performed very well in terms of RWC, free proline concentration and yield [12].

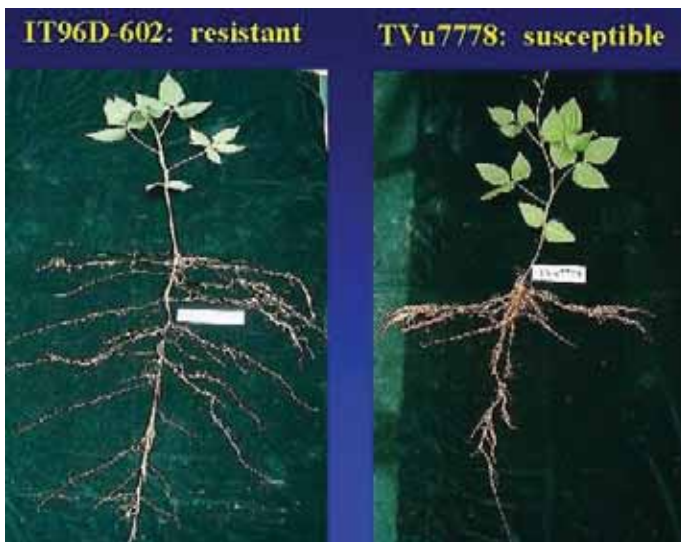

Figure 1 Root distribution patterns of the cowpea drought tolerant control line IT96D-602 and the more susceptible line TVu7778.

Roots of mature plants were also assessed using a pin-board root-box as a method for identifying the role of root characteristics in drought tolerance [7]. The variation observed between the drought-tolerant control (IT96D-602) and drought-sensitive control (TVu7778) indicates differences in the distribution of the roots, but not in total root length. The tendency of the drought-tolerant cultivar was to increase the amount of roots in the lower levels of the box, while the distribution of the roots of the sensitive cultivar was more at the top of the soil (Fig. 1, [12]). The distribution of the roots in the mutant plants was similar to that of the drought-tolerant cultivar, enabling them to access soil in the deep soil layers. This tendency was also observed by Matsui [13].

The first part of the project enabled the identification of a number of drought tolerant mutant lines based on data recorded for agronomic, morphological and physiological traits. The genomic knowledge for cowpea, with a chromosome number of 22 ($2n=2x$) and a genome size of ± 600 Mb, is very limited [14], thus the second aim of the project was to further characterize the most promising mutant lines using molecular techniques.

The first molecular analysis that was performed involved random RAPD studies. The RAPD technique utilizes low-stringency polymerase chain reaction (PCR) amplification with single primers of arbitrary sequence to generate strain-specific arrays of anonymous DNA fragments [15]. Polymorphism was scored by looking at the banding patterns of the DNA fragments, as well as the number of bands per primers. Ten mutant cowpea lines were drought stressed for 21 days, together with the drought-tolerant line, IT96D-602, and parent line, IT93K129-4. RAPD analysis was conducted using various RAPD primers to screen the DNA samples from these lines. All of the primers amplified the DNA, but some (OPA08 and OPA10) did not show clear discrimination, and were therefore not used for subsequent experiments. The remaining 12 primers yielded either one or two polymorphic RAPD bands. Although the level of polymorphism observed was very low, this analysis gave some indication of the genetic variation between the mutant and the control lines tested. The mutant lines Cp-m447 and Cp-m217 displayed different banding pattern with most of the primer tested when compared to the other lines (Table 1).

Table 1. Summary of the OPA and OPH primers used for RAPD analysis.

Primers	Lines & Controls								
	1	2	3	4	5	6	7	8	9
OPA-01		√		•	√				•
OPA-04				√		√	•		
OPA-08					Not clear				
OPA-10					Not clear				
OPA-12		√			? •				
OPA-19		√					√		
OPA-20	•				√				•
OPH-05					√				
OPH-08					√				
OPH-09					√				
OPH-11					√				
OPH-12		√		√					
OPH-14		√		•					
OPH-15			√				√	√	

1-10: 1: IT96D602; 2: IT93K129-4; 3: Cp-m26; 4: Cp-m164; 5: CP-m217; 6: Cp-m364; 7: Cp-m447; 8: Cp-MA1; 9: Cp-MA2. The blue tick and red dot were used as an indication of polymorphism.

The two mutant lines, Cp-m217 and Cp-m447, were subsequently grown in a greenhouse together with the parent line IT93K129-4. Samples were taken from the drought stressed plants at different time points to identify changes in gene expression by cDNA-AFLP transcript profiling. The AFLP technique is based on the selective PCR amplification of restriction fragments from a total digest of genomic DNA [11]. The cDNA-AFLP based marker system was used to detect polymorphism in the lines at the transcript level in response to the onset of drought stress. Primers representing EcoRI-ACT and MseI-CCT, gave reproducible profiles. A DNA fragment was found to be present in the mutant fingerprints but absent from the parental fingerprints. Band intensities, as well as presence and absence of the bands were scored. No polymorphic bands were observed between the lines at the 0 day time point which was evidence for the close homology of the genotypes. However, from the fourth to the 24th day of drought stress, there were clear differences in the transcript banding patterns between the mutant lines.

Nucleotide sequences of the transcript-derived fragments (TDF) were compared with nucleotide sequences of the expressed sequence tag (EST) databases by using the BLAST sequence alignment programme. Best database match and identity at the nucleotide level were obtained using the blastn and blastx programmes [16]. The first nine transcript-derived fragments of cowpea that were sequenced were found to have best matches with cDNA sequences cloned from soybean and common bean. Some of the identified transcripts exhibited similarity to published sequences, including a leucine rich protein, a NADH dehydrogenase subunit, a GTP binding protein and a transducin-like protein, indicating possible involvement in plant cell defense, energy and signal transduction.

Reverse transcription (RT)-PCR analysis was performed on six randomly selected TDF to verify the reliability of the cDNA-AFLP profile. A semi-quantitative PCR method was used to study the expression of some of the transcripts derived fragments. The 18S ribosomal RNA gene was used as an internal control. Primers (Cp-Mp56 & Cp-Mp60) were designed from the sequences of the TDF 56 and 60. As additional controls, primers from previously identified drought-induced Cowpea genes were also used to amplify the cDNA isolated for this experiment (Generation Challenge Programme: Cp-001, Cp-002, Cp-099). A similar expression pattern as with the cDNA-AFLP profile was observed, validating the cDNA-AFLP results.

The third aim was to evaluate the selected mutant lines on station and at different communities. Twelve mutant cowpea lines, together with drought tolerant line, IT96D-602, and parent line, IT93K129-4, were planted under dry land conditions at Kgora Resource Center near Mafikeng, North West Province. The majority of cowpea growers are women. They grow cowpea because it provides food for their families, and they can sell the grain in local market, or to traders, generating cash for household needs. Cowpea suffers heavily from insects, both in the field as well as when the grain is stored after harvest. The community members were thus trained in different production aspects such as soil preparation, fertilization and scouting for pests and diseases (Fig. 2). No significant differences were observed in yield between the different cowpea mutant lines. However, marked differences in growth habits were observed. Certain lines can only be used as a pulse crop, where the more spreading (indeterminate) growers can also be used as a leafy green vegetable. Being able to plant and evaluate the different lines themselves and not just being told that the one line is better than the other, was very important to the community members. They could not believe that the plants produced a good yield on soils without fertilizer.

The on station trials at ARC VOPI were planted in a randomized split plot design with two treatments, one irrigated and one dry land. Three replicates were included in every treatment and the lines were randomized within a treatment. On station field trials were conducted at the ARC-VOPI's research farm under dry land as well as irrigation

conditions for the last two seasons. The mean yields for the cowpea during the last season varied between 112g and 862.23g in the dry land treatment, with a grand mean of 312g. There were three replicates in the treatment and 16 degrees of freedom. The mean yield for the cowpea varied between 93.9g and 310.2g in the irrigation treatment, with a grand mean of 186.6g. There were three replicates in the treatment and 16 degrees of freedom.



Figure 2 Community members were trained in different production facets.

The long term plan is to introgress the drought tolerance trait from the best mutant line into drought susceptible South African cultivars grown by the communities. This will also enable the identification and development of markers that are associated with drought tolerance to be further used in Marker-Assisted Selection in the existing cowpea breeding programmes.

ACKNOWLEDGEMENTS

The authors would like to thank the International Atomic Energy Agency and the Agricultural Research Council for funding of this project, as well as all the researchers and assistants that assisted in the laboratory, greenhouse and field.

BIBLIOGRAPHY

- Hall, A.E. Emerging Technologies to Benefit Africa and South Asia. Talk to the National Research Council committee of The National Academies, <http://dels.nas.edu/banr/gates1/docs/mtg3docs/Hall.doc> (2007).
- Davis, D.W., Oelke, E.A., Oplinger, E.S., Doll, J.D., Hanson, C.V., Putnam, D.H. Cowpea. In: *Alternative Field Crops*, <http://www.hort.purdue.edu/newcrop/afcm/cowpea.html> (2000).
- IITA. Cowpea, http://www.iita.org/cms/details/cowpea_project_details.aspx (2007)
- Network For The Genetic Improvement Of Cowpea For Africa. NGICA, Cowpea, <http://www.entm.purdue.edu/NGICA/cowpea.html> (2008).
- Cowpea, www.cowpea.org (2008).
- Labuschagne, M.T., Verhoeven, R., Nkouanessi, M. Drought tolerance assessment of African cowpea accessions based on stomatal behaviour and cell membrane stability. *The Journal of Agricultural Science*, Published online by Cambridge University Press (2008).
- Singh, B.B., Mai-Kodomi, Y., Terao, T. A simple screening method for drought tolerance in cowpea. *Indian Journal Genetics* 59(2), 211-220 (1999).
- Bates, L.S., Waldren, R.P., Teare, I.D. Rapid determination of free proline for water-stress studies. *Plant Soil* 39, 205-207 (1973).

9. De Ronde, J.A., Laurie, R.N., Caetano, T., Greyling, M.M., Kerepesi, I. Comparative study between transgenic and non transgenic soybean lines proved transgenic lines to be more drought tolerant. *Euphytica* **138**(2), 123-132 (2004).
10. Fall, L., Diouf, D., Fall-Ndiaye, M.A., Badiane, F.A., Gueye, M. Genetic diversity in cowpea [*Vigna unguiculata* (L.) Walp.] varieties determined by ARA and RAPD techniques. *African Journal of Biotechnology* **2**, 48-50 (2003).
11. Vos, P., Hogers, R., Bleeker, M., Reijans, M., Van De Lee, T., Hornes, M., Frijters, A., Pot, J., Peleman, J., Kuiper, M., Zabeau, M. AFLP: A new technique for DNA fingerprinting. *Nucleic Acids Research* **23**, 4407-4414 (1995).
12. De Ronde, J.A., Spreeth, M.H. Development and evaluation of drought resistant mutant germplasm of *Vigna unguiculata*. *Water SA* **33**(3), 381-386 (2007).
13. Matsui, T., Singh, B.B. Root characteristics in cowpea related to drought tolerance at the seedling stage. *Experimental Agriculture* **39**(1), 29-38 (2003).
14. Das, S., Bhat, P.R., Sudhakar, C., Ehlers, J.D., Wanamaker, S., Roberts, P.A., Cui, X., Close, T.J. Detection and validation of single feature polymorphisms in cowpea (*Vigna unguiculata* L. Walp) using a soybean genome array. *BMC Genomics* **9**, 107 (2008).
15. Ouédraogo, J.T., Gowda, B.S., Jean, M., Close, T.J., Ehlers, J.D., Hall, A.E., Gillaspie, A.G., Roberts, P.A., Ismail, A.M., Bruening, G., Gepts, P., Timko, M.P., Belzile, F.J. An improved genetic linkage map for cowpea (*Vigna unguiculata* L.) combining AFLP, RFLP, RAPD, biochemical markers and biological resistance traits. *Genome* **45**, 175-188 (2002).
16. BLAST Programme, <http://blast.ncbi.nlm.nih.gov/Blast.cgi> (2008).

Radiation Induced *In Vitro* Mutagenesis, Selection for Salt Tolerance and Characterization in Sugarcane

P Suprasanna^{*}, V Y Patade, E R Vaidya¹ & V D Patil²

Abstract

Salinity is one of the major environmental stresses affecting plant productivity. Combined use of mutagenesis and tissue culture can greatly facilitate the selection and isolation of useful tolerant lines. In the present study, *in vitro* mutagenesis was employed in the selection of salt tolerant lines in popular sugarcane (*Saccharum officinarum* L.) cv. CoC-671. Embryogenic cultures were gamma irradiated (10-50Gy) and challenged with different levels of NaCl (42.8 - 256.7 mM). Salt-stressed calli exhibited lower relative growth rate, decreased cell viability and higher levels of free proline and glycine betaine. The membrane damage (electrolyte leakage) was threefold more under salt stress compared to control. The ion levels were drastically affected under salt stress as leached out Na⁺ and K⁺ was much more than that retained in tissue in both adapted and unadapted callus cultures. The tolerance could also be related to the maintenance of better water status and a high to low level of K⁺ to Na⁺ under salinity stress, indicating that sugarcane can be a Na⁺ excluder. Plant regeneration was observed in 10 and 20Gy irradiated calli up to 171.1 mM NaCl selection. A total of 147 plantlets were selected on different salt levels and the tolerant lines are being evaluated at field level. Molecular characterization using RAPD markers revealed genetic polymorphism among selected putative salt tolerant lines and control plants. In addition, plantlets regenerated from irradiated calli of sugarcane cv. CoC-671, Co 86032 and Co 94012 were field planted and agronomically desirable variants were identified for economic traits like cane yield and sucrose (Brix). The genetic stability of the variants is being evaluated at field level in M₃ generation. The proper evaluation of these variants for salinity tolerance may be useful for economic cultivation under the stress regime.

Introduction

Sugarcane (*Saccharum officinarum* L.) is an important agro-industrial sugar crop, contributing about 70% of the world sugar production. Being a typical glycophyte, it exhibits stunted growth or no growth under salinity, with its yield falling to 50% or even more of its true potential [1]. Somaclonal variation in combination with *in vitro* mutagenesis can be beneficial for the isolation of salinity and drought tolerant lines in a short duration employing *in vitro* selection. In sugarcane, studies have been conducted on isolating mutants resistant to red rot, water logging and delayed flowering [2,3] and salt tolerance [4]. In this study, results are presented on the Gamma-ray mutagenesis *in vitro*, followed by selection for salinity and drought tolerance and characterization of the putative salt and drought-tolerant regenerants of sugarcane cv. CoC-671.

Materials and Methods

Establishment of embryogenic cultures, *in vitro* mutagenesis and selection Embryogenic callus cultures of popular Indian sugarcane cultivars CoC-671, Co 86032 and Co 94012 were established [5] from young leaf explants on callus induction medium-CIM containing MS basal salts supplemented with 100 mg l⁻¹ malt extract, 100 mg l⁻¹ L-glutamine, 1000 mg l⁻¹ casein hydrolysate, 50 ml l⁻¹ coconut water, 2.0 mg l⁻¹ 2,4-D, 30 g l⁻¹ sucrose and 2.0 g l⁻¹ gelrite. The cultures were maintained through regular subcultures on fresh induction medium under a 16h photoperiod (30 μmol m⁻² s⁻¹ PFD) at 25±2°C and 70% RH.

Embryogenic calli were subjected to gamma radiation using ⁶⁰Co as a source in Gamma Cell 220 at dose rate of 9.6Gy/min. The irradiation doses were 10, 20, 30, 40 or 50Gy. Radiation treated calli were immediately cultured on CIM to eliminate the radiolysis hazards and subcultured for at least thrice, at monthly interval, on the same medium (CIM) before using for further studies. Survival percent of the calli was recorded in terms of White Proliferating Clumps (WPCs).

Gamma-irradiated sugarcane (cv. CoC-671) calli (200 mg) were cultured on CIM supplemented with different levels of salt-NaCl (42.8, 85.6, 128.3, 171.1, 213.9, 256.7, 299.5 or 342.2 mM). Callus growth was determined in terms of relative growth rate (RGR) after four weeks of culture on salt selection medium. The putatively tolerant calli were exposed for salt selection in subsequent cycles.

Salt stressed calli was used for the estimation of free proline, glycine betaine, membrane stability index in terms of electrolyte leakage, and Na⁺ and K⁺ as per the methods described earlier [5, 6].

Each treatment consisted of 15 calli (five per each 9.5cm dia. culture plate) and the values are given in the form of mean±standard error. Experiments consisting of treatments and control were replicated thrice and analysis of variance (ANOVA) was carried out using IRRISTAT programme.

Plantlets were regenerated after two to three weeks of transfer of salt selected calli on regeneration medium, i.e., CIM without 2,4-D. About 5cm long individual shoots were transferred on ½ MS medium with 2 mg l⁻¹ NAA for rooting. The regeneration efficiency was expressed in terms of number of plantlets regenerated in a particular treatment of gamma irradiation and salt stress. The rooted plantlets were hardened in the green house.

The radiation induced plant population (derived from *in vitro* mutagenesis) of sugarcane cv. CoC-671, Co 94012 and Co 86032 were field planted and at maturity stage, data was collected on various agronomic traits including number of millable canes, stool weight, number of internodes, cane weight, cane diameter, H.R. Brix of sugarcane variant and control plants. The variants that performed better over checks are being field evaluated in M₃ generation under Rod Row Trial.

RAPD analysis

Genomic DNA was isolated from leaf tissue (50mg) of the selected tolerant lines. The OD of different samples was taken at 260 nm and the

Nuclear Agriculture & Biotechnology Division, Bhabha Atomic Research Centre, Trombay, Mumbai 400 085

¹ Department of Agricultural Botany, Dr. P.D. Krishi Vidyapeeth, Akola 444104,

² A.D.G. Pulses & Oilseeds, Indian Council of Agricultural Research, New Delhi, India

* Corresponding author. E-mail: prasanna@barc.gov.in

samples were then diluted so as to get the final concentration at 50ng/ μ l. The different components of PCR, viz. genomic DNA (50, 100, 150 or 200 ng), MgCl₂ (1.5, 2.5 or 3.5 mM) and Taq DNA polymerase (0.5 or 0.6U) and different annealing temperatures (35, 36, 37, 38, 39 or 40°C) were optimized to get appropriate amplification product.

Based on the previous investigations on RAPD analysis carried out with sugarcane embryogenic cultures and somaclones in this laboratory, the 60 decamer oligonucleotide primers from Operon Technology Inc., USA were considered. Among the primers screened, the best-suited nine primers (OPA-02, OPA-03, OPH-3, OPH-4, OPH-5, OPH-7, OPH-9, OPH-12 and OPH-19) that showed distinct banding pattern were selected for the present RAPD study.

PCR Amplification reactions were performed in a MJ Research, USA (PTC100) thermalcycler. The reaction conditions were initial denaturation at 94°C for five minutes, 40 cycles each consisting of denaturation step of one minute at 94°C, primer annealing at 37°C for 1.5 minutes, primer extension at 72°C for two minutes, and final extension step at 72°C for 10 minutes. The amplified products were subjected to agarose gel electrophoresis using 1.5% agarose and the gels were analyzed on a gel documentation system.

RAPD bands were scored as present (1) or absent (0). The data was used for similarity-based analysis using the programme NTSYS-Pc (version 2.02) developed by Rohlf [7]. Jaccards coefficient (F) was calculated using the programme SIMQUAL. Similarity coefficients were used to construct UPGMA (Unweighted Pair Group Method with Average) dendrogram.

Results and Discussion

The 20Gy irradiated cultures exhibited almost 50% survival response. Salt selections with 85.6 mM and above showed significantly lower relative growth rate as compared to control calli (Fig. 1A, 1B). Cell viability decreased drastically in salt-stressed calli (0.91 ± 0.12) as compared to the control (53.16 ± 0.39). Salt-stressed calli also exhibited higher levels of free proline and glycine betaine. In general, membrane damage rate in terms of electrolyte leakage was found to be more (almost three-fold) under salt stress (88.57 ± 1.75) as against control condition (30.92 ± 1.5). The ion levels were drastically affected under salt stress, as leached out Na⁺ and K⁺ was much more than that retained in tissue of both adapted and unadapted callus cultures. The sodium leached in both adapted and unadapted callus increased progressively with increasing salt concentration. Potassium, leached and retained, in both adapted and unadapted callus did not exhibit much variation. This accumulation of salt ions could play an important role in osmotic adjustment in stressed sugarcane cells. The tolerance could also be related to the maintenance of an ample water status and a high to low level of K⁺ to Na⁺ under salinity stress. Such a mechanism implies that sugarcane can be considered as a Na⁺ excluder. In case of 10 and 20Gy irradiated calli, regeneration was observed up to 85.6 mM salt selection medium, whereas higher treatments (128.3 mM and beyond) exhibited browning initially. However, in the subsequent subcultures, regeneration was obtained in case of 10 and 20Gy irradiated calli on 128.3 and 171.1 mM salt selections. Higher gamma irradiation (40Gy) also showed regeneration but only with 85.6 mM salt selection. The unirradiated calli regenerated highest number of plantlets followed by 10 and 20Gy irradiated calli on salt selection. A total of 147 plantlets were selected on different salt levels.

Molecular characterization based on RAPD analysis revealed genetic polymorphism between the selected putative salt-tolerant lines from the control plants (Fig. 1C). RAPD analysis of the putatively tolerant regenerants resolved 72 scorable markers from nine out of 60 primers screened. On an average, each primer produced eight bands. The amplification products ranged from 0.1 kb to 2 kb. The primer OPH-05 produced maximum 10 bands, out of which three were polymorphic. The primer OPH-09 produced five polymorphic bands from a total of

nine bands. An interesting observation was recorded in case of RAPD profile obtained from primer OPH-07 (Fig. 1C). An intense non-parental band was obtained among the selected drought-tolerant lines. But the band intensity decreased with increasing selection pressure of PEG. The genetic similarity between the control and salt-tolerant lines ranged between 0.63 and 0.80.

A wide range of mutations for morphological, quality and yield contributing characters were obtained through *in vitro* mutagenesis using gamma irradiation (Fig. 2). For morphological traits, mutation spectrum was broader in Co 94012, while for quality and yield traits, Co 86032 showed a wide range of mutations. A total of 44 clones were identified for various desirable agronomic traits. Clones (AKTS 2, 7, 11 of CoC 671; AKTS 22, 26, 27 of Co 86032; AKTS 36,38,39, 44 of Co 94012) performed better over respective checks for average cane weight and H.R. Brix (% sucrose).

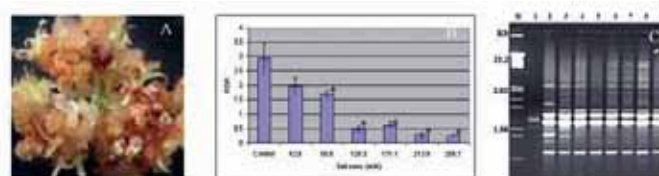

Figure 1 (A) 20Gy irradiated and 171.1 mM salt selected calli, (B) Relative growth rate of salt stressed calli. Asterisk indicates significant differences over control at $P\leq 0.05$, (C) RAPD profile obtained with primer OPH-7.



Figure 2 Field evaluation of Gamma-ray induced variants of sugarcane. (A) variants for canopy trait; (B) field view of irradiated plant population (M₂); (C) variant for no. of tillers and (D) variant for spineless sheath.

The crop improvement programme can be speeded up by combining the radiation mutagenesis with *in vitro* culture [8]. *In vitro* techniques allow for the rapid execution of propagation cycles of subculture aimed to separate mutated from non-mutated sectors [9]. Tissue culture induced variation may offer additional variation to that induced through mutagenesis and such a variation can be most effective if it is successfully associated with cellular level selection and handling of large populations for screening [10]. This approach has contributed to genetic improvement in several crop plants such as pineapple, banana and grape.

Detection of variants is of immense importance in order to utilize these lines in crop improvement. RAPD is widely used to study the variation at DNA level among the variants and technique has proved very sensitive for the characterization, salinity-tolerant plants in sugarcane. The salt-tolerant lines are being evaluated at the field level for their genetic stability. The proper evaluation of these radiation-induced variants tolerant to salinity may be useful for economic cultivation under stress conditions. The genetically stable variants for various economic traits may be released for commercial cultivation.

BIBLIOGRAPHY

1. Rozeff, N. Sugarcane and salinity - a review. *Sugarcane* 5, 8-19 (1995).
2. Majid, M.A., Shamsuzzaman, K.M., Howlader, M.A.R., Islam, M.M. Development of sugarcane mutants with resistance to red rot, water logging and delayed for non-flowering through induced mutations. *IAEA-Tecdoc*. 1227, 31-44 (2001).

3. Saif, U.R., Rashid, M., Asad, S., Zafar, Y., Washeed R.A. Use of radiation and *in vitro* techniques for development of salt tolerant mutants in sugarcane and potato. *IAEA-Tecdoc*. **1227**, 51-60 (2001).
4. Samad, M.A., Begum, S., Majid M.A. Somaclonal variation and irradiation in sugarcane calli for selection against red rot, waterlogged conditions and delayed or non-flowering characters. *IAEA-Tecdoc*. **1227**, 45-50 (2001).
5. Patade, V.Y., Suprasanna, P., Bapat, V.A. Gamma irradiation of embryogenic callus cultures and *in vitro* selection for salt tolerance in sugarcane (*Saccharum officinarum* L.). *Agri. Sciences (China)* **7**(9), 101-105 (2008).
6. Patade, V.Y., Suprasanna, P., Bapat, V.A. Effects of salt stress in relation to osmotic adjustment on sugarcane (*Saccharum officinarum* L.) callus cultures. *Plant growth Regulation* **55**(3), 169-173 (2008).
7. Rouhlf, F.J. NTSYS. Numerical Taxonomy And Multi Variate Analysis System version 2.02. Applied Biostatistics, New York (1990).
8. Maluszynski, M., Ahloowalia, B.S., Sigurbjoornsson, B. Application of *in vitro* mutation techniques for crop improvement. *Euphytica* **85**, 303-315 (1995).
9. Ahloowalia, B.S. *In vitro* techniques and mutagenesis for the improvement of vegetatively propagated plants. In: *Somaclonal Variation and Induced Mutations in Crop Improvement* (Jain S.M., Brar D.S. & Ahloowalia B.S. (eds)), Kluwer Acad. Pub., Dordrecht, 293-309 (1998).
10. Patade, V.Y., Suprasanna, P. Radiation induced *in vitro* mutagenesis for sugarcane improvement. Special Issue on Biotechnology, (Ed). Suprasanna P, *Sugar Tech.* **10**(1), 14-19 (2008).

Development of Salt-tolerant High-yielding Barley Lines via Crossing Between a Mutant Induced by EMS and a Local Cultivar

R A K Moustafa

Abstract

In the winter season of 2002/2003, a high-yielding barley mutant line and a local variety were hybridized to obtain the salt tolerance of the local variety and the high yield potential of the induced mutant in one genotype. The obtained hybrid grains were planted in the 2003/2004 growing season under normal field irrigation conditions to raise F_1 population, which was grown in the 2004/2005 season to advance F_2 generation under saline conditions at El-Fayoum experimental agriculture station belonging to the Nuclear Research Center. Phenotypic correlation coefficients between grain yield and its effective traits were estimated for F_2 plant population. Results revealed that the characters most strongly correlated with grain yield were found to be number of spikes and biological yield/plant. Therefore, these couple traits were used as a selection criterion to screen F_2 plant population in order to detect high yielding variants under salinity conditions. As a result, a considerable number of outstanding individual plants was selected from the large F_2 population and their grains were planted in 2005/2006 winter season to raise F_3 progeny rows. Superior plants from superior rows were selected and carried forward to the next winter season of 2006/2007 as F_4 single plant progenies along with the two parental genotypes and a suitable check. Obtained results indicated that mean values of yield and most of its components for the tested progeny lines were significantly ($P=0.1$) surpassed averages of the original parents and the check as well.

Keywords:

Barley – EMS – Crossing – Variation – Correlation – Selection – Salt tolerance

Introduction

Barley (*Hordeum vulgare*, L.) is one of the most important winter crops in Egypt and is used in many bakery preparations and energy-rich foods for human consumption. It is also grown for feeding animals and green forage. Additionally, barley grains can be used in the malting brewing industry. The national production of barley is generally low since it is mostly planted in the desert or on salt affected soils. The productivity of barley crop under these environments is very low and estimated at 1.26 t/ha versus 3.74 t/ha in the fertile lands of the Nile Valley [1]. However, about 420,000 h. of these fertile lands are damaged by excess soluble salts and exchangeable sodium accumulation [2]. Therefore, the present study aimed to create genetic variability and selection for salt-tolerant high-yielding barley lines derived from a manual crossing between a high-yielding mutant and a local cultivar tolerant to salinity, but lower in terms of yield potential.

Materials and Methods

A high-yielding mutant line namely Mutant 7 (Mut. 7) induced by a concentration of 0.15% EMS (4h treatment) was crossed with the local

variety Giza 123 (G.123) in the 2002/2003 winter season with a view to combine in one genotype salt tolerance of G.123 and the high yield potential of Mut.7. The obtained hybrid grains were planted in the subsequent growing season of 2003/2004 under normal field irrigation conditions to raise F_1 population, which was grown in 2004/2005 winter season to advance F_2 generation under saline conditions at El-Fayoum experimental station belonging to the Nuclear Research Center (NRC).

Simple phenotypic correlation coefficient between grain yield and related traits were estimated for F_2 population to detect the most important traits that are associated with grain yield to be utilized as a criterion to select high-yielding variants with improving tolerance to salinity stress. F_2 selected plants were grown in the winter season of 2005/2006 to raise F_3 individual progeny rows. Superior plants from the best rows were selected and carried forward to the next season of 2006/2007 as F_4 progeny lines. At the end of the growing season, all developed progeny lines were screened and those of high mean productivity were harvested individually and kept for further evaluation.

Field experiments were carried out using a randomized complete block design. Both F_3 and F_4 progeny rows were grown in two replicates owing to the limited seeds number of their single plant parents. The experimental plot comprised two rows, 3m long and 20cm apart; spacing of plants was 10cm apart. Consequently, 120 individual plant per each progeny were developed either in F_3 or F_4 generations.

Table 1. Mechanical properties of El-Fayoum experimental soil

Depth (cm)	Particles size distribution%			Texture class
	Sand	Silt	Clay	
0-15	20.0	73.6	5.4	Silty loam
15-30	31.2	65.6	3.2	Silty loam
30-45	22.9	71.9	5.2	Silty loam
45-60	49.6	47.2	3.2	Sandy loam
60-75	20.3	75.4	4.3	Silty loam

Table 2. Chemical properties of El-Fayoum experimental soil

Depth (cm)	pH	Anions (meq/L)				Cations (meq/L)				SAR	Available, ppm		
		SO4=	Cl-	HCO3-	CO3=	K+	Na+	Mg++	Ca++		N	P	K
0-30	8.18	41.0	32.5	2.0	-	0.64	59.36	4.5	11	87	64.5	5.5	343.2

Soil analysis

2004/2005 and 2005/2006 growing seasons Representative soil samples from El-Fayoum experimental site were taken to the depth of 75cm to determine some physical and chemical properties (Tables 1 & 2 and Fig. 1). Soil analysis indicated that the site is silty loam texture with the exception of 45-60cm depth, whereas the texture is sandy loam. The concentrations of the available nitrogen and

Nuclear Research Center, Egyptian Atomic Energy Authority, Cairo, Egypt

E-mail: r_moustafa99@yahoo.com

phosphorus are moderate, while, the available potassium is high. The site has $EC_e=9.21$ (Fig.1) and irrigated with fresh water ($EC_w=0.8$ ds/m).

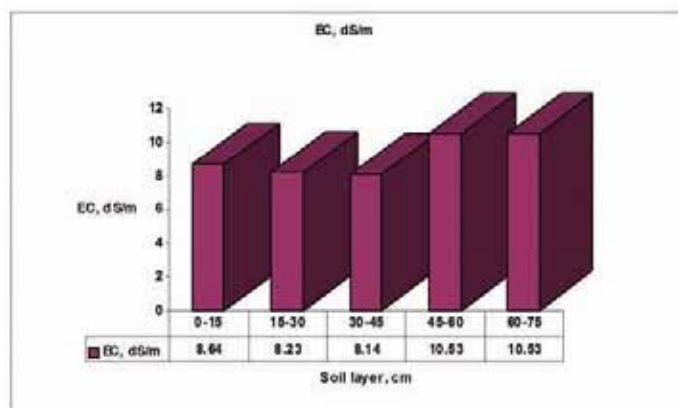

Figure 1 Average EC_e of different layers of El-Fayoum saline soil.

2006/2007 growing season

The field experiment was carried out in another part of El-Fayoum site has an average $EC_e=12.7$ ds/m. The aim was to evaluate F_4 progeny lines under higher salt pressure.

Data recorded

The studied traits in F_2 - F_4 barley populations were plant height (cm), spike length (cm), number of spikes/plant, 100-grain weight (gm), bio-

logical yield /plant (gm), straw yield/plant (gm), harvest index and grain yield /plant(gm).

Statistical analysis

The data obtained were subjected to the proper statistical analysis of variance described by [3]. The L.S.D. test was used for comparison between means of F_4 progeny lines. Phenotypic correlation coefficients between yield and yield components were calculated according to [4].

Results and Discussion

As it will be known, yield is the ultimate criterion which a plant breeder has always to keep in view in his attempts to evolve improved types of any crop plant. However, yield itself is not a unitary character, but is the result of the interaction of a number of factors inherent both in the plant as well as in the environment in which the plant grows. It therefore becomes difficult to evaluate or select based on this complex trait directly. Accordingly, plant breeders may resort to more indirect methods such as determination of the association existing between other less variable characters and yield. Selection pressure may then be more easily exerted on any of the traits which show close association with yield [5]. On this basis, simple phenotypic correlation coefficients were estimated for F_2 barley population of the Mut.7 x G.123 cross to determine the most important traits that are associated with grain yield under salinity-stressed conditions at El-Fayoum environment. Data in Table 3 indicates the presence of highly significant positive correlation between grain yield/plant and plant height, number of spikes/plant, biological yield /plant and 100-grain weight. These findings are in accordance with those previously obtained by several investigators studied the relation-

Table 3. Simple correlation coefficients between studied traits of F_2 barley population of the cross Mut.7 x G.123 at El-Fayoum salt affected soil.

Characters	Plant height	Spike length	No. of spikes/ plant	100-grain weight	Biological yield/plant	Harvest index
Spike length	0.204*					
No. of spikes/plant	0.058	-0.16				
100-grain weight	0.258**	-0.031	0.316**			
Biological yield/plant	0.178	0.074	0.808**	0.332**		
Harvest index	-0.218*	0.081	0.134	0.112	0.085	
Grain yield/plant	0.261**	0.165	0.803**	0.415**	0.786**	0.054

Table 4. Mean values of yield and yield components of F_4 progeny lines compared to their parental and the check genotypes under saline conditions at El-fayoum location.

Genotype	Spike length (cm)	No. of spikes/ plant	100-grain weight (g)	Biological yield/ plant (g)	Grain yield/ plant (g)	Straw yield/ plant (g)	Harvest index
Giza 123 (parent)	5.72	5.69	4.86	32.83	10.33	22.46	31.46
Mutant 7 (parent)	5.50	5.67	5.21	29.61	9.73	19.91	32.76
Giza 2000 (check)	6.14	6.02	5.41	31.73	8.92	22.76	28.11
Mut.7 x G.123 selected progeny lines							
No. 1	7.30	7.92	4.50	49.01	18.02	31.0	36.77
No. 2	7.05	14.67	5.92	50.04	17.38	32.68	34.75
No. 3	7.03	11.00	4.59	69.08	23.17	45.90	35.54
No. 4	6.45	12.56	4.83	66.75	23.55	43.18	35.18
No. 5	7.00	16.73	4.86	66.03	22.18	43.85	33.60
No. 6	7.00	15.14	4.26	65.13	20.67	44.51	31.65
No. 7	7.30	7.92	4.50	49.01	18.02	31.0	36.66
No. 8	7.75	10.68	4.80	61.31	17.26	44.09	28.12
No. 9	7.20	9.75	4.71	52.82	17.54	35.30	33.22
L.S.D							
0.05	0.582	3.399	1.042	2.341	0.800	1.897	3.20
0.01	0.822	4.796	1.470	3.303	1.128	2.677	3.147

ship between yield and yield components in barley under different environmental conditions [6, 7, 8, 9, 10, 11, 12, 13]. However, the two characters most strongly correlated with grain yield were found to be number of spikes/plant ($r=0.803$) and biological yield/plant ($r=0.786$). Estimate of correlation, between these two traits, however, was greater in magnitude than other two studied characters (**Table 3**). In this respect, [13] found high significant positive correlation between barley grain yield and both spikes number and biological yield/plant under stressed and non-stressed conditions, suggesting that selection for these two characters would be useful for increasing barley grain yield under different environments.

Based on the results of the correlation studies, all F_2 plant population was screened and resulted in selection a considerable number of outstanding variants showing high spike number, biological yield, and at the same time yielded more grains than the average of the best plants of the related tolerant parent cultivar by at least 25%. The selected plants were grown in F_3 as plant-progeny rows. Superior plants from superior rows were picked out and carried forward to the next growing season as F_4 progeny lines, which were screened, and eventually, the most promising lines retained the high yielding productive of their elite F_3 individuals were selected. Mean values of yield and its attributes for the progeny lines compared to the original parents Mut.7 and G.123 as well as G.2000 check cultivar are given in **Table 4**.

As shown in **Table 4**, means of yield and yield components of F_4 progeny lines exhibited marked increases, mostly reaching the limits of significance ($P=0.01$) over the averages of Mut.7 and G.123 cross parents and G.2000 the check variety. The exception was noticed for 100-grain weight of the progeny lines, were insignificantly decreased as compared to the averages of the parents and the check genotypes. These reductions, however, reached the limits of significance between the progeny line No.6 and the check (**Table 4**). The selected progeny lines will be further evaluated in multi-location trials under different saline-stressed environments to confirm their breeding values.

ACKNOWLEDGMENTS

I express my gratitude to International Atomic Energy Agency (IAEA) for financial support of this investigation which is a part of the project entitled "Identification and pyramiding of mutated genes: novel approaches for improving crop tolerance to salinity and drought." Contract no. EGY 12990.

BIBLIOGRAPHY

1. Agriculture statistics. Ministry of Agriculture and Land Reclamation. Vol.1, 23-24 (1999).
2. Badawi, A.A. Policy of rice varieties in Egypt. (Proc. of First Pl. Breed) *J.Plant Breed.* **3**, 29-51 (1999).
3. Snedecor, G.W., Cochran, W.C. Statistical methods (6th ed.) Iowa State Univ. Press, Iowa, U.S.A (1969).
4. Le Clerg, El., Leonard, W.H., Clark, A.G. Field. Plot Technique. *Library of Congress Catalog* **62**, 16455 (1962).
5. Kedharnath, S., Joshi, A.B., Batcha, M.G.B.R. Correlation studies in *Linum usitatissimum*. Effect of morphological grouping of types on the correlation coefficients relating to yield and some of the components of yield. *Indian J. Ganet.* **20**, 50-68 (1960).
6. Verna, S.F., Naresh., K., Lamba, R.A.S., Kumar, N.K. Combining ability and heterosis in some indigenous and exotic barley. *Crop Improvement* **3**, 70-71 (1976).
7. Tahir, M., Shad, L. Preliminary studies on some morphological characteristics contributing to drought tolerance in winter cereals. *Rachis* **2** (1983).
8. Sethi, S.K., Pardo, R.S., Singh, D. Combining ability for Harvest index and grain yield in barley. *Crop Improvement* **14**, 157-159 (1987).
9. Sariam, R.K., Singh, S.S. N-use efficiency. *N-assimilation and Morphophysiological traits in barely and wheat Newsletter* **8**(2) (1989).
10. Noaman, M. M., El-sayed, A. A, Abo-Elenin, R.A., Assad, F. A. Screening for drought tolerance barley genotypes for rainfed areas. *Agric. Res. Review. Egypt* **67**, 51-57 (1989).
11. El-Bawab, A.M.O. Response of some barley cultivars to grow under different environment conditions. *Ph.D Thesis* (1994).
12. Sundeep, C., Kumar., L.C., Kumar S. Variability and correlation studies in barley (*Hordeum vulgare* L.) *Research on Crops* **3**, 432 -436 (2002).
13. Abd.El-Salam, S.G.A. Studies on breeding for drought tolerance in barley. *M.Sc Thesis* (2005).

Genetic Enhancement of Lentil (*Lens culinaris* Medikus) for Drought Tolerance through Induced Mutations

J P Lal* & A K Tomer

Abstract

An attempt has been made to isolate a number of drought-tolerant mutants from four lentil cultivars, two small seeded (PL-639 and PL-406) and two bold seeded (K-75 and L-4076) groups by treating the seeds with physical (10, 20 and 30 kR of γ -rays) and chemical mutagens (0.04M of ethyl methane sulfonate and 0.05M of sodium azide) separately and in various combinations. The experiment was initiated during the winter season of 1999-2000 and carried over to advanced generations. The selection of environment (water stress or non-stress) for the development of drought-resistant varieties still remains controversial, however, the findings from present study suggest that materials ought to be tested in both stress and non-stress conditions so that the favourable alleles under drought can be maintained as well as selection response under favourable condition can be maximized. Yield under drought (Y_d), yield potential (Y_p), drought susceptibility index (S) and geometric mean (GM) were considered as the potential indicators for drought resistance of a family. Correlation coefficients between these parameters were calculated for selecting the parameter(s) which are more effective than others for screening the drought-resistant mutant line(s). It was observed that GM was positively and significantly correlated with both Y_d and Y_p , whereas it was negatively, but insignificantly correlated with S. There was significant, but negative correlation between S and Y_p , while no significant correlation between S and Y_d was observed. From the correlation studies it may be concluded that for the enhancement of yield potential under both the conditions, selection should be based on GM rather than on S. Because S is a better measure of drought tolerance than a measure of performance under stress, genotypes may be first selected on the basis of high GM and then on the basis of high yield under drought (Y_d). Twenty mutant lines selected on the basis of higher GM than their respective control, and were further evaluated for their yield performance under rainfed conditions and were subjected to drought tolerance tests through M_4 to M_6 generations. Three chemical tests, viz., nitrate reductase (NR) activity, protein content, and wax content were conducted and data were recorded on grain yield/plant. Nitrate reductase activity and wax content of most of the mutant lines were higher than their respective control and both were positively associated with grain yield, while protein content was lower in the mutant lines and was negatively associated with grain yield in that comparison. The lines showing higher nitrate reductase activity, wax content and grain yield appeared to be promising.

Introduction

Drought continues to be a challenge to agricultural scientists in general, and to plant breeders in particular, despite many decades of research. Breeding for drought tolerance involves identification and transfer of

morpho-physiological and biochemical traits that may impart drought tolerance to high-yielding cultivars [1-3].

Research in the past has shown that plants tolerate drought stress to some extent by accumulating osmolytes [4-5]. Through a comparative analysis for drought tolerance, it was concluded that the drought tolerance seemed to be associated at least in part with its ability to maintain greater levels of amino acid pool, coupled with more pronounced re-assimilation of ammonia [6]. A positive and significant correlation of nitrate reductase (NR) with protein accumulation and seed yield in different cultivars has been reported [7]. The importance of epicuticular wax content in relation to drought tolerance has also been discussed and analysed by several workers [8-10]. The highest osmotic adjustment along with high wax content was found responsible for two drought-tolerant accessions out of nine studied in lentil [11].

Looking at the importance of drought and lentil, the objectives of this paper is to find out the parameters to form the basis of selection and the environment under which the mutants/materials are to be screened for drought tolerance/resistance coupled with higher grain yield.

Materials and Methods

The experiments were carried out with the promising 20 mutant lines isolated from four lentil cultivars, two small seeded (PL-639 and PL-406) and two bold seeded (K.75 and L.4076) groups. The seeds of these cultivars were treated with physical (10, 20 and 30 kR of Gamma-rays) and chemical mutagens [0.04 M of ethyl methane sulphonate (EMS) and 0.05M sodium azide (SA)], separately and in various combinations, and were grown during the winter season of 1999-2000 as M_1 generation and carried over to advanced generations.

M_1 and M_2 generations were grown under moisture stress (rainfed) conditions while M_3 was grown under two environments viz. moisture stress (rainfed) and moisture non-stress (i.e. one supplemental irrigation just before blooming). A proportion of M_3 families were selected on a high geometric mean (GM). Within this group, a second selection was performed based on high yield under drought (Y_d) to ensure the maintenance of yield performance under stress [12]. Finally 20 mutant lines were selected and were subjected to drought tolerance tests through M_4 to M_6 generations. Three chemical tests, viz. NR activity in leaf samples was determined in vivo method as described by [13], total seed protein was estimated by using Micro-Kjeldahl method [14] and wax content through spectrophotometer following the standard procedures.

Results and Discussion

Drought tolerance in M_3 generation

One of the objectives of this investigation was to select plants for drought tolerance/resistance and the character(s) to form the basis for the selection. The magnitude of the induced genetic variability was assessed in the M_2 and was utilized for the selection of plants for further evaluation in M^3 generation. Further, these selected plants were grown under two environmental conditions as described above to assess the drought sus-

Department of Genetics & Plant Breeding, Institute of Agricultural Sciences, Banaras Hindu University, Varanasi (221 005), India.

* Corresponding author. E-mail: jplalbh@yahoo.com

ceptibility index. Drought susceptibility/resistance of a family in the field was assessed through the measurement of yield under moisture stress (Y_d), under moisture non-stress, i.e. full genetic yield potential (Y_p), drought susceptibility index (S) and geometric mean (GM). These were considered as the potential indicators for drought tolerance/ resistance of a family and therefore, calculations were made on these parameters. On the basis of these parameters (Y_d , Y_p , S, GM) promising mutant lines were selected. But it was difficult to conclude which parameter(s) were more effective than others for screening the drought-resistant mutant line(s). To solve this problem, correlation studies were made for each cultivar between the drought parameters and shown in **Table 1**. All the combinations of these parameters showed highly significant correlations, except the correlation between S and Y_p and S and GM in all the four cultivars. In general, highest correlation coefficients were noticed

between GM and Y_p in PL-639 (0.977), PL- 406 (0.973) and K.75 (0.961) and between Y_d and Y_p in L.4076 (0.933).

Chemical test in M_4 to M_6 generations

A number of mutant lines were promising for drought tolerance/resistance and were selected on the basis of GM in M_3 generation (**Table 2**). Only 20 mutant lines (six each from PL-639 and L.4076; five from PL-406 and three from K.75) showing the highest GM within each cultivar were further evaluated through M_4 to M_6 generations. Three chemical tests viz. protein content, NR activity and wax content were conducted and the mean values of each test along with the yield per plant are presented in **Table 3**. All the mutant lines showed significant positive correlations between grain yield and NR activity (0.382) and between grain yield and wax content (0.466). It was observed that NR activity and wax content of most of the mutant lines were higher than their respective control, while the reverse was true for protein content. Out of 20 mutant lines screened through chemical tests, there were two mutant lines in PL-639 (T3-4 and T3-1) and one in PL-406 (T10-3) and one in L 4076 (T3-3) which showed higher values of all the tests as compared to their respective controls.

An overall observation suggested that some cultivars were more resistant to water stress than others, the reason being that at cellular level, plants tolerate drought stress to some degree by accumulating osmolytes [4-5] and most of these osmolytes are nitrogenous compounds, hence nitrogen metabolism is of utmost importance under stress conditions. In this study, NR activity was found positively correlated with the grain yield as was also reported by [7]. Both positive [15-16] and negative [17-18] correlations were noted between the protein content and grain yield. Induced mutants with increased, as well as reduced seed protein content were reported in different pulse crops [19]. In this study also, it was

Table 1. Correlation between yield under stress (Y_d) and non-stress (Y_p), geometric mean (GM), and drought susceptibility index (S) for lentil cultivars PL- 639, PL- 406, K- 75 and L- 4076 in M_3 generation.

Traits	Correlation co-efficients			
	PL- 639	PL- 406	K. 75	L. 4076
Y_d & Y_p	0.682*	0.972*	0.855*	0.933*
S & Y_d	-0.219*	-0.243*	-0.329*	-0.224*
S & Y_p	0.167	-0.087	0.071	0.183
S & GM	-0.032	-0.123	-0.099	-0.008
GM & Y_d	0.756*	0.967*	0.928*	0.902*
GM & Y_p	0.977*	0.973*	0.961*	0.887*

* significant at the 0.05 probability level

Table 2. Promising mutant lines in each cultivar selected on the basis of geometric mean in M_3 generation.

Mutant line	Description	Y_p	Rank	Y_d	Rank	GM	Rank	S	Rank
PL- 639	Control	4.80	6	4.16	23	4.47	18	2.14	64
T2-3	3rd line of 10 kR	4.98	1	4.73	4	4.85	1	0.90	36
T11-6	11th line of SA + 20 kR	4.80	6	4.78	2	4.78	2	0.07	4
T11-1	1st line of SA + 20 kR	4.80	6	4.74	3	4.76	3	0.22	11
T9-6	6th line SA	4.86	2	4.63	9	4.74	4	0.85	35
T3-4	4th line of 20 kR	4.85	3	4.64	8	4.74	4	0.78	32
T3-1	1st line of 20 kR	4.74	9	4.70	6	4.71	5	0.45	16
PL- 406	Control	5.16	5	4.88	13	5.02	5	2.10	61
T2-6	6th line of 20 kR	5.18	4	5.10	3	5.13	1	0.39	17
T11-6	6th line of SA + 20 kR	5.10	6	5.04	4	5.11	2	0.29	14
T3-5	5th line of 20 kR	5.10	6	5.02	5	5.05	3	0.39	17
T9-3	3rd line of SA	5.18	4	4.89	12	5.03	4	1.42	50
T10-3	3rd line of SA + 10 kR	5.35	7	5.00	6	5.02	5	0.25	13
K. 75	Control	5.34	1	4.97	5	5.14	3	1.40	52
T10-4	4th line of SA + 10 kR	5.18	5	5.13	4	5.15	1	0.23	15
T2-7	7th line of 10 kR	5.30	2	5.21	1	5.25	2	0.41	19
T12-1	1st line of SA + 30 kR	5.16	6	5.14	3	5.14	3	0.09	10
L. 4076	Control	5.18	3	4.79	14	4.98	6	1.60	43
T2-1	1st line of 10 kR	5.20	2	5.10	1	5.14	1	0.52	21
T2-7	7th line of 10 kR	5.13	5	5.00	2	5.06	2	0.69	27
T3-3	3rd line of 20 kR	5.23	1	4.88	7	5.05	3	1.82	49
T3-4	4th line of 20 kR	5.10	6	4.93	4	5.01	4	0.90	34
T11-4	4th line of SA + 20kR	4.99	10	4.99	3	4.99	5	0.00	9
T11-5	5th line SA+20 kR	5.06	7	4.84	9	4.94	6	1.18	36

Table 3. Mean of protein content NR activity, wax content and grain yield per plant (averaged over M₁ to M₆ generations).

PL- 639 Control	24.15	1.82	146.22	4.12
T2-3	21.22	2.42	164.78	4.93
T11-6	24.06	2.30	152.63	4.71
T11-1	24.10	2.28	152.98	4.69
T9-6	23.98	2.38	162.94	4.75
T3-4	24.42	2.08	159.12	4.62
T3-1	24.16	2.20	164.62	4.73
PL- 406 Control	24.32	1.98	164.62	4.32
T2-6	23.90	2.60	173.15	4.88
T11-6	24.16	1.99	182.32	5.29
T3-5	24.06	2.73	182.48	4.76
T9-3	24.10	2.44	169.26	4.33
T10-3	24.42	2.82	184.82	5.73
K. 75 Control	25.48	2.28	152.24	4.06
T10-4	23.78	2.59	199.06	4.12
T2-7	23.92	2.31	183.31	5.34
T12-1	24.82	2.29	157.22	4.24
L. 4076 Control	24.08	1.98	160.35	4.19
T2-1	23.76	2.75	161.45	4.94
T2-7	23.10	2.49	187.12	4.89
T3-3	24.27	2.17	189.82	4.92
T3-4	22.58	1.92	179.28	4.69
T11-4	23.76	2.34	192.42	4.95
T11-5	23.84	2.23	181.32	4.78

observed that the protein content was negatively correlated with grain yield (-0.272). Unlike the protein content, there was significant positive correlation between grain yield and wax content (0.466). A stable cell membrane that remains functional during water stress appears central to adaptation to high temperatures and was found to be related to heat and drought tolerance [20-21]. A genotypic difference in thermo stability of membrane was observed by [22]. They concluded that a cell membrane was more thermo stable when it was covered with a sufficient quantity of wax.

Thus, it may be concluded that the selection of mutants/plants be done on the basis of higher NR activity, wax content and higher grain yield under drought (moisture stress) conditions.

BIBLIOGRAPHY

- Blum, A. Evidence for genetic variability in drought resistance and its implication for plant breeding. In: *Drought Resistance in Crop with Emphasis on Rice*. IRRI, Philippines, 53-68 (1983).

- Morgan, J.M. Osmoregulation and water stress in higher plants. *Ann. Plant Physiol.* **35**, 292-319 (1984).
- Singh, P., Choudhary, A.K. Selection criteria for drought tolerance in Indian mustard [*Brassica juncea* (L)] Czern & Coss]. *Indian J. Genet.* **63**(3), 263-264 (2003).
- Bartels, D., Nelson, D. Approaches to improve stress tolerance using molecular genetic. *Plant Cell Environ.* **17**, 659-667 (1994).
- Bohnert, H.J. *et al.* Adaptation to environmental stresses. *Plant Cell* **7**, 1099-1111 (1995).
- Ramanjulu, S., Sudhakar, C. Drought tolerance is partly related to amino acid accumulation and ammonia assimilation: a comparative study in two mulberry genotypes differing in drought sensitivity. *J. Plant Physiol.* **150**, 345-350 (1997).
- Pandey, U.N., Singh, B.B. Nitrate reductase in relation to grain yield in lentil (*Lens esculenta* Moench.). *Indian J. Plant Physiol.* **34**(2), 196-197 (1991).
- Haley, S.D. *et al.* Excised leaf water status evaluation and association in field-grown winter wheat. *Canadian J. Plant Sci.* **73**(1), 55-63 (1993).
- Shivashankar, S., Nagaraja, K.V. Effect of water stress on enzyme activities of two coconut genotypes differing in drought tolerance. *Plant Physiol. Biochem.* **23**(2), 187-193 (1996).
- Manzanares, M. *et al.* Contribution of some physiological traits to drought tolerance in peas (*Pisum sativum* L.). 3rd European Conference on Grain Legumes. Opportunities for High Quality, Healthy and Added-Value Crops to Meet European Demands. Valladolid, Spain, 38-39 (1998).
- Asharf, M. *et al.* Variation in osmotic adjustment of accession of lentil (*Lens culinaris* Medik.) in response to drought stress. *Acta Bot. Neerlandica.* **41**(1), 51-62 (1992).
- Schneider, K.A. *et al.* Improving common bean performance under drought stress. *Crop Sci.* **37**, 43-50 (1997).
- Srivastava, H.S. In vivo activity of nitrate reductase in maize seedlings. *Indian J. Biochem. Biophys.* **11**, 230-232 (1974).
- Sadasivam, S., Maniekam, A. Nitrogen analysis by Micro-Kjedahl method. In: *Biochem. Methods* (2nd Ed.) New Age Int. (P) Publisher. New Delhi, 34-36 (1996).
- Kumar, H., Lal, J.P. Efficient method of handling M₁ plants in Indian mustard (*Brassica juncea* Czern and Coss) - High yielding and Alternaria leaf blight tolerant. *Cruciferae News Let.* **21**, 125-130 (1999).
- El-Far, I.A. Response of lentil to seedling rate and drought at different growth stages. *Assiut J. Agric. Sci.* **31**, 163- 176 (2000).
- Hamdi, A. *et al.* Relationships among economic characters in lentil. *Euphytica* **57**(2), 109-116 (1991).
- Kumar, R. *et al.* Correlation studies in lentil. *Ann. Bio.* **18**(2), 121-123 (2002).
- Gottschalk, W., Wolff, G. Induced mutation in Plant Breeding. Springer-Verlag, Berlin, (1993).
- Sullivan, C.Y., Ross, W.M. Selecting for drought and heat resistance in grain sorghum. In: *Stress Physiology in Crop Plants*. (MUSSELL, H., STAPLES, R.C. Ed.) Wiley-Inter Science, New York, 262-281 (1979).
- Raison, J.K. *et al.* Membrane properties in relation to the adaptation of plant to temperature stress. In: *Adaptation of Plants to Water and High Temperature Stress* (TURNER, N.C., KRAMER, P.J. Ed.) John Wiley and Sons, New York, 261-273 (1980).
- Wallner, S.J. *et al.* Measurement of turf grass heat tolerance *in vitro*. *J. American Soc. Hort. Sci.* **107**, 608-613 (1982).

CONCURRENT SESSION 5

Induced Mutations for Enhancing Crop Quality and Nutrition

Induced Mutation-facilitated Genetic Studies of Seed Phosphorus

V Raboy

Abstract

Both the chemical composition and total amount of seed phosphorus (P) are important to the end-use quality of cereal and legume seed crops, whether for use in human foods or animal feeds. They are also important to the management of P in agricultural production, and to the long-term sustainability of that production. About 75% ($\pm 10\%$) of seed total P is found as phytic acid (*myo*-inositol-1,2,3,4,5,6-hexakisphosphate). Mutations that block the synthesis or accumulation of phytic acid during seed development, often referred to as *low phytic acid* (*lpa*) mutations, have been isolated in maize (*Zea mays* L.), barley (*Hordeum vulgare* L.), rice (*Oryza sativa* L.), wheat (*Triticum aestivum* L.) and soybean (*Glycine max* L. (Merr.)). Chromosomal mapping has identified as many as six non-allelic *lpa* loci in a single species (barley). Studies of *lpa* mutants has enhanced knowledge of the genes and proteins important to phytic acid P metabolism. While there has been substantial research into the biology of P uptake by plants, there has been little progress in the genetics of seed total P. Genetic factors that either decrease or increase seed total P might be of value for both enhancing the end-use quality of seed crops and for optimizing the utilization of P during agricultural production. As proof-of-principle, homozygosity for recessive alleles of barley *lpa1* both blocks seed phytic acid accumulation by 50% and reduces seed total P by 15%, while having little impact on yield. The current status of *lpa* genetics and current efforts at isolating “seed-total P” mutants, using both forward and reverse genetics approaches, will be described.

Introduction

Engineering the total amount of seed phosphorus (P) or its chemical composition may improve the nutritional quality of grains for use in human foods and animal feeds. Both are also important to the management of P in agricultural production, and to the long-term sustainability of that production [1]. The amount of P annually sequestered in seeds represents a sum equivalent to ~65% of the fertilizer P applied annually, worldwide [2]. The readily available reserves for P fertilizer production worldwide may be consumed within 50 to 150 years [3]. Thus the availability of P for fertilizer may soon prove limiting to world food production. Genetic approaches to engineering optimal seed P amount and chemistry could play an important role both in enhancing food and feed quality and in managing the use and environmental impact of P in agricultural production.

About 75% ($\pm 10\%$) of seed total P is found as phytic acid (*myo*-inositol-1,2,3,4,5,6-hexakisphosphate or Ins P₆, Fig. 1A). Seed phytic acid represents a major bottleneck in the flux of P through the agricultural ecosystem. This compound is not efficiently digested and utilized by non-ruminant, monogastric animals such as poultry, swine, fish and humans (nutritional issues related to seed phytic acid are reviewed in [1]). As a result, grains and legumes are a poor source of nutritionally-

available P when used in non-ruminant feeds. Excretion of phytic acid P by non-ruminant livestock also represents a significant environmental hazard due to its potential contribution to eutrophication. The seed-derived phytic acid content of foods can function as an anti-nutrient in human diets. Dietary phytic acid binds tightly to nutritionally important minerals such as iron and zinc. Subsequent excretion of these iron and zinc-containing phytate salts can contribute to mineral deficiency, a major public health issue in the developing world. Dietary phytic acid may also have health-beneficial roles, such as an anti-oxidant and anti-cancer agent.

The chemistry of seed total P is not a major issue when grains and legumes are used in ruminant production, such as in dairy or beef production. Ruminants digest most P in feeds, regardless of its composition or chemical form. However, the total amount of seed P is an important issue. As with monogastric production, high levels of P in ruminant waste represents an environmental hazard [4]. This issue has been exacerbated by the increasing use of grain and legume products in biofuels production [5]. An important side product of milling of maize (*Zea mays* L.) for biofuels production is “Distiller’s Dry Grains” (DDGs). DDGs usually have a higher total P level than do whole grains, and use of DDGs in livestock production can result in high levels of waste P. One approach to this problem would be to use genetics to reduce the total P of seed, and thus of DDGs. Therefore genetic approaches to reducing seed total P may prove important in reducing the need for P in food and agricultural production. If 65% of the total amount of P removed from crop production fields is removed as seed P, reducing seed P by 25% to 50% has the potential for contributing significantly to enhanced management of this limited resource.

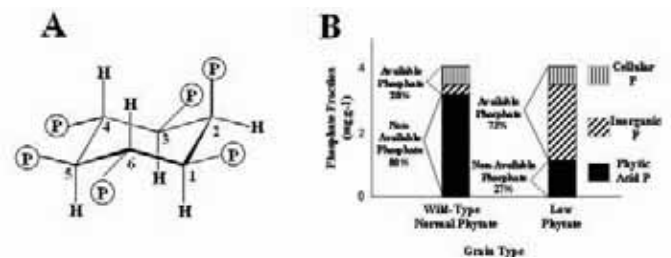

Figure 1 (A) Chemical structure of phytic acid (*myo*-inositol-1,2,3,4,5,6-hexakisphosphate or Ins P₆). Numbers refer to the carbon atoms in the *myo*-inositol (Ins) backbone. “P”=H₂PO₄. (B) Seed phosphate fractions in standard “wild-type” grains and legumes and in an example of low-phytate lines or cultivars. “Cellular P” represents the sum of all P-containing compounds other than phytic acid P and inorganic P, such as DNA, RNA, proteins, lipids and carbohydrates. “Available” and “Non-Available” Phosphate refers to nutritional availability for non-ruminants such as poultry, swine and fish, and is based on the assumption that “available P” for non-ruminants approximately equals non-phytic acid P, the sum of all P other than phytic acid P.

Phytic acid genetics

Mutations that block the synthesis or accumulation of phytic acid during seed development, often referred to as *low phytic acid* (*lpa*) mutations

USDA Agricultural Research Service, Small Grains and Potato Germplasm Research Unit, Aberdeen, Idaho, USA

E-mail: victor.raboy@ars.usda.gov

(Table 1) have been isolated in maize (*Zea mays* L.) [6-10], barley (*Hordeum vulgare* L.) [11-15]; rice (*Oryza sativa* L.), [16-20]; wheat (*Triticum aestivum* L.) [21]; and soybean (*Glycine max* L. (Merr.)) [22-26]. Chromosomal mapping has identified as many as six non-allelic *lpa* loci in a single species (barley) [15].

Studies of the inheritance of the soybean M153 mutant [22] illustrates how new types of genetic screens and new genotypes sometimes illuminate pre-existing genetic variation that was not phenotypically visible. In the case of soybean M153, inheritance studies [23, 24] indicate that the mutant seed phenotype requires homozygosity for recessive alleles at two loci, now termed soybean *pha1* and *pha2* (Table 1). However, the generation via chemical mutagenesis of two non-linked recessive alleles and their capture as a “double homozygote” in a single M_2 is a very rare event; it would occur roughly in 1×10^6 individuals and it is unlikely that this rare individual would then be identified in a screen of only about 1,000 M_2 s [22]. It is far more likely that the chemical mutagenesis generated a recessive allele at either *pha1* or *pha2*, and that the soybean population contained a previously existing recessive allele at the second locus that had no clear phenotype of its own.

Progress in identifying the genes perturbed in *lpa* mutants has greatly advanced our knowledge of phytic acid metabolism in plants. The identification of maize *Zmlpa3* and *Zmlpa2* as encoding an Ins kinase and an $\text{Ins}(1,3,4)\text{P}_3$ 5-/6-kinase, respectively, provided strong evidence for the “lipid-independent” pathway to phytic acid. Previous genetics studies with *Arabidopsis* and other eukaryotes had mostly supported a “lipid-dependent” pathway [27]. Identification of maize *Zmlpa1* as encoding an “ABC-transporter” represented the first transport function shown to have some role in phytic acid synthesis/accumulation in any organism [9]. Recently, rice *Oslpa1* was recently shown [18, 20] to encode a protein the closest relative of which is an archaeal 2-phosphoglycerate (2-PGA) kinase, which converts 2-PGA to 2,3-bis-PGA. There are at least two ways the plant homolog of this protein may function in phytic acid synthesis/accumulation. First, 2,3-bis-PGA is a potent inhibitor of phosphatases, the activities of which might block the accumulation of phytic acid. Thus, production of 2,3-bis-PGA might serve to regulate

metabolic pathways such that phytic acid accumulates. Alternatively, the protein encoded by rice *lpa1* might function as an inositol monophosphate kinase, which converts Ins monophosphates to Ins bisphosphates. This type of kinase currently represents the “missing link” in the “lipid-independent” pathway to phytic acid.

Agronomic studies of *lpa* genotypes

There has been substantial concern over the impact of the low-phytate trait on crop yield. Nearly all *lpa* mutations impact phytic acid synthesis and probably other functions in both seed and vegetative tissues, and thus have negative effects on germination, emergence, stress tolerance, vegetative growth and, ultimately, yield. One of the arguments for the use of genetic engineering in producing the low-phytate trait is that it allows for targeting the trait to specific seed tissues, avoiding impacts on vegetative growth, and thus provides a way for producing high-yielding crops with the low-phytate trait [9]. However, results with two barley *lpa* mutations indicate that mutation genetics might be able to accomplish the same thing. Barley *lpa1-1* and *lpa-M640* have been used to breed two released cultivars, “Herald” and “Clearwater,” respectively [28, 29]. Both have excellent yields when tested in a variety of environments. Interestingly, both mutations appear to result in a seed-tissue-specific phenotype; they impact phytic acid synthesis only in the aleurone layer, and not in other seed tissues. Perhaps their high yields are due to this seed tissue-targeting which may limit impact on plant/vegetative growth and function.

A second interesting agronomic finding concerns the soybean LR33-Mips and M153 mutants. Both mutants impact field emergence, and other seed function traits like germination, but the effect is much greater if the seed source subsequently tested was produced in tropical environments rather than temperate environments [30, 31]. Seeds of these genotypes produced in temperate environments display much better emergence when planted in either temperate or tropical fields. This effect is not due specifically to the lesion in the LR33 Mips gene, since it is observed in both LR33 and M153, and is not due generally to the low-phytate trait, since a third soybean *lpa* mutation, *lpa-ZC-2*,

Table 1. Low phytic acid loci of cereal and legume crops^a

Species	Locus	Map Position	Seed Phosphorus (P), Phytic Acid (PA), Inorganic P (Pi), Inositol (Ins) and Ins Phosphate Phenotype
Maize	<i>lpa1</i>	1S	Allele-specific, variable reductions in PA, by 50% to >90%, matched by increased Pi. Increased Ins.
	<i>lpa2</i>	1S	~50%-reduced PA, matched by increased Pi and increased “lower” Ins phosphates such as Ins P4 and Ins P5. Increased Ins.
	<i>lpa3</i>	1S	Largely embryo-specific ~50%-reduced PA matched by increased Pi. Increased Ins.
Wheat	<i>Js-12-LPA</i>	Not Known	~35%-reduced PA, matched by increased Pi. Possibly due to inheritance of alleles at two loci. Alters distribution of P in kernel: increased endosperm P, reduced bran P.
Barley	<i>lpa1</i>	2H	Aleurone/Endosperm-specific ~50%-reduced PA, matched by increased Pi. ~15%-reduced seed total P.
	<i>lpa2</i>	7H	~50%-reduced PA, matched by increased Pi and increased “lower” Ins phosphates such as Ins P4 and Ins P5. Increased Ins.
	<i>lpa3</i>	1H	~70%-reduced PA, matched by increased Pi. Increased Ins.
	<i>lpa-M640</i>	7H	Aleurone/Endosperm-specific ~50%-reduced PA, matched by increased Pi. ~15%-reduced seed total P.
	<i>lpa-M593</i>	4H	~50%-reduced PA. Other linked mutants, all possibly alleles of MIPS gene, have PA reductions from ~10% to >90%.
	<i>lpa-M955</i>	1H	>90%-reduced PA, matched by increased Pi. Increased Ins.
Rice	<i>lpa1</i>	2	~40%-reduced PA, matched by increased Pi.
	<i>Lpa-N15-186</i>	3	~75%-reduced PA, matched by increased Pi.
	<i>lpa-XS110-1</i>	3	~65%-reduced PA, matched by increased Pi.
Soybean	<i>pha1</i>	LG N	~80%-reduced PA, matched by increased Pi, when plants homozygous for both <i>pha1</i> and <i>pha2</i> . Originally isolated as one of two loci contributing to “M153”. Reduced field emergence enhanced if seed produced in tropical environment.
	<i>pha2</i>	LG L	~80%-reduced PA, matched by increased Pi, when plants homozygous for both <i>pha1</i> and <i>pha2</i> . Originally isolated as one of two loci contributing to “M153”. Reduced field emergence enhanced if seed produced in tropical environment.
	<i>lpa-ZC-2</i>	LGB2	~50%-reduced PA, matched by increased Pi and increased “lower” Ins phosphates. Less effect on field emergence than observed for other soybean <i>lpa</i> mutations.
	LR 33-MIPS	Not Known	Ins decreased 60% to 80%. PA decreased ~50%. Reduced field emergence enhanced if seed produced in tropical environment.

^a Please see the following references for each species: Maize, [6-10]; Barley, [11-15]; Rice, [16-20]; Wheat, [21]; Soybean, [22-26].

does not appear to display this effect [25]. Understanding the underlying biology of this effect would no doubt enhance the understanding of seed biology, and may also be important to the successful development of high-yielding low-phytate crops. This phenomenon hasn't been studied in any of the cereal crop genotypes. Perhaps it might prove important in crops grown in tropical environments, like maize and rice.

Breeding studies with the low-phytate soybean genotypes has also shown that backcrossing and selection for yield within a set of low-phytate lines or segregants can identify lines with improved field emergence and yield [32]. It is not surprising that those mutations that greatly alter metabolism of P, inositol and inositol phosphate, each critical to many processes in cells, tissues and organs of seeds and plants, might impact germination, emergence, and other functions and metabolic pathways that impact yield. For example, a study of genome-wide gene expression during seed development of the barley mutant *lpa*-M955, homozygosity for which nearly abolishes the cell's ability to synthesize phytic acid, found that the expression of a small subset of genes was greatly suppressed during seed development of mutant versus wild-type seeds [33]. These genes are important to carbohydrate metabolism, cell wall metabolism, transport functions and cytokinin and ethylene signalling. These and other lines of evidence suggest that it was premature to expect, and counterproductive to require, that the first crop variants homozygous for *lpa* mutations would perform as well as standard lines, without breeding and selection for productivity and yield. Since these first generation *lpa* lines represent novel genotypes with novel metabolism, it probably should not be surprising that selection for yield might be able to identify favourable non-linked modifiers and allelic variants that restore performance and yield.

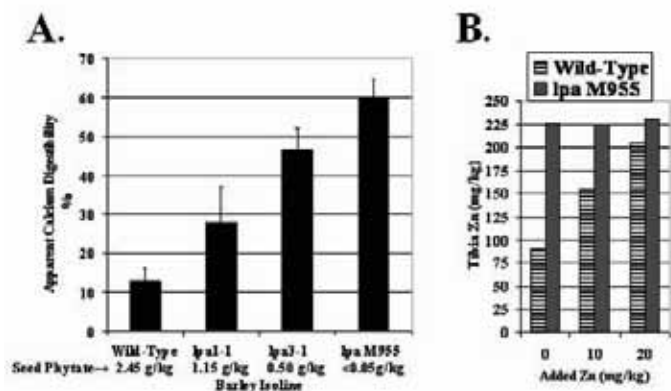

Figure 2 Enhancement of calcium (A) and zinc (B) nutrition in animals consuming diets based on low phytic acid barley lines. (A) Trout were raised on four diets consisting of either wild-type barley cultivar that has normal levels of phytic acid, or three barley low phytic acid isolines (*lpa*1-1, *lpa*3-1 and *lpa*-M955), that produce grain with progressively bigger reductions in phytic acid [37]. All diets consisted of 30% barley and contained similar levels of calcium (530 mg kg⁻¹ for *lpa*1-1 to 590 mg kg⁻¹ for W-T). (B) Chicks were fed diets consisting of either the wild-type barley cultivar or *lpa*-M955, whose grain has a reduction in phytic acid of >90%, and that were supplemented with either 0.0, 10 or 20 mg kg⁻¹ zinc [38]. Diets contained 60% barley and had similar levels of zinc (~26 mg kg⁻¹ zinc).

Human and animal nutrition studies using *lpa* genotypes

In terms of animal feeds, the primary interest in the low-phytate trait is its high “available P” for non-ruminant animals such as poultry, swine and fish. Many studies (reviewed in [1]) have shown that if formulated properly to take into account *lpa* seed's high “available” P (illustrated in Fig. 1B), non-ruminant animals utilize and absorb a greater fraction of seed total P, and excrete concomitantly less P. In terms of human nutrition, the primary interest in the low-phytate trait has been the potential enhancement in mineral nutrition it may provide for those populations that rely on cereal grains and legumes as staple, bulk foods. A series of studies have shown that fractional absorption of iron, zinc and calcium by human volunteer test subjects is increased 30% to 50% when consum-

ing meals prepared with *lpa* maize versus “normal phytate” maize [34-36]. Two studies with barley *lpa* genotypes and model animal systems (trout and chickens) illustrate some important points concerning the potential enhancement of mineral nutrition made possible by the low-phytate trait. In the first study (Fig. 2A) trout were raised on four diets prepared with either “normal phytate” barley (wild-type, 2.45 g phytic acid P kg⁻¹), or with three low-phytate types with increasing reductions in grain phytic acid P (*lpa*1-1, 1.15 mg kg⁻¹ phytic acid P; *lpa*3-1, 0.5 g kg⁻¹ phytic acid P; *lpa*-M955, <0.05 g kg⁻¹ phytic acid P). Barley represented 30% of the total diet. A strikingly linear, inverse relationship between dietary phytic acid and “apparent calcium digestibility”, a measure of the animal's retention and use of calcium in the diet, was observed. Calcium retention is critical to bone health and perhaps overlooked in the general discussion of the role of dietary phytic acid in human health and nutrition. Also, it is clear that incremental decreases in dietary phytic acid may result in incremental increases in calcium availability. In other words, there is no critical threshold of reduction in dietary phytic acid necessary to achieve a demonstrated improvement in mineral nutrition.

In the second study (Fig. 2B) chicks were fed either wild-type barley or a near-isogenic line homozygous for *lpa*-M955, whose grain has >90% less phytic acid, and these diets were supplemented with either 0.0, 10 or 20 mg kg⁻¹ zinc [38]. The bone (tibia) zinc data given in Fig. 2B is representative of the results of various measures of zinc nutritional status obtained in the study. The results in Fig. 2B indicate that zinc supplementation was only of value (increased tibia zinc) if the chicks were fed wild-type barley. Chicks fed *lpa*-M955 barley had uniformly high bone zinc and this was not improved by zinc supplementation. Clearly the near absence of phytic acid in the diet allowed for optimal use of the seed-derived dietary zinc. These results also indicate that the level of endogenous zinc in these barleys (~24 mg kg⁻¹) is adequate for optimal growth and health, if dietary phytic acid is greatly reduced, as it is in *lpa*-M955. These sorts of results should be taken into account when public health officials develop strategies for dealing with mineral deficiency in nations with populations that rely on cereals and legumes as staple foods. In this context, while supplementation with iron or zinc may ameliorate either iron or zinc deficiency, reduction in dietary phytic acid may simultaneously enhance both iron and zinc nutrition, and improve nutritional status for calcium and other nutritionally important minerals. This is because dietary phytic acid plays a “global” role in mineral nutrition, simultaneously impacting several nutritionally-important minerals.

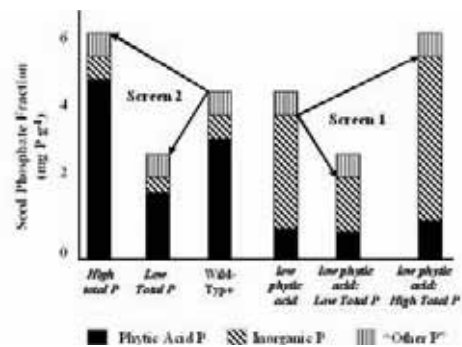

Figure 3 Two types of screens for altered seed total P. Screen No. 1 uses an assay for inorganic P and is for mutations that alter the seed inorganic P phenotype of *lpa* mutations. Screen No. 2 uses a seed total P assay and will be used with both wild-type and *lpa* populations. On the right is a parental low phytic acid line and two hypothetical second-site mutations derived from it that either increase or decrease seed total P in a low phytic acid background. On the left is a “normal phytic acid” wild-type parental line and two hypothetical mutations that either increase or decrease seed total P in a “normal phytic acid” background.

Screening for “seed total P” mutations

There has been relatively little progress in the genetics of seed total P. A great deal of research has addressed the biology of P uptake by plants,

and thus the genetics of vegetative or “plant P” level [39]. For example, many mutations have been studied in *Arabidopsis* that impact root or shoot total P. However, there are relatively few reports concerning the genetics of seed total P. Interestingly, homozygosity for recessive alleles of barley *lpa1* or *lpa-M640* both blocks seed phytic acid accumulation by 50% and reduces seed total P by 15%, while having little impact on yield [12, 28, 29]. These are the only reports of single-gene mutations that have this effect. We are currently pursuing both forward and reverse genetics approaches to isolating “low-seed-total P” mutants. **Fig. 3** illustrates two types of forward genetic screens. In Screen 1 (**Fig. 3 right**) a high-throughput inorganic P assay is used to screen progeny obtained following the chemical mutagenesis of an *lpa* genotype for any mutation that alters the high-inorganic P phenotype typical of that parental *lpa* genotype. The assumption is that mutations that increase or decrease seed total P will increase or decrease the inorganic P in seed of an *lpa* line, since in an *lpa* genotype inorganic P represents that bulk of seed total P. One interesting thing to note is that the hypothetical “low phytic acid:low total P” mutant illustrated in **Fig. 3** might turn out to have the ideal seed P amount and chemistry for nearly all end-uses since its both low-total P and still “high inorganic P/high available P”, as compared with wild-type. The barley *lpa1* and M640 mutations represent proof-of-principal that such a seed chemistry phenotype is achievable, but we would like to find mutations that reduce seed total P by at least 25%. In Screen 2 (**Fig. 3 left**) following chemical mutagenesis of a normal-phytate, wild-type line, seed is screened directly for mutations that alter seed total P, using a high-throughput assay for total tissue P. Although absolute levels of seed phytic acid are altered in these later hypothetical mutants, they have “normal phytic acid” in the sense that the ability of seeds to synthesize phytic acid is not perturbed, and the proportion of total P found as phytic acid P is not altered.

Conclusions

In addition to the *lpa* forward genetics work described above, much progress has also been made in reverse genetics approaches to issues relating to seed phytic acid. For example, transformation with a bacterial phytase gene targeted to the cytoplasm shows great promise as one approach to developing high-yielding low-phytate crops [40]. Other traditional methods like recurrent selection may also prove valuable in developing low-seed-total P crops [41]. Therefore, many tools obtained from traditional breeding, and forward and reverse genetics will be available to deal with issues having to do with seed total P and its chemistry.

ACKNOWLEDGMENTS

This work was supported by a number of entities including the U.S. Dept. of Agriculture’s Ag. Research Service and its CSREES National Research Initiative competitive grants programme, the North American Barley Genome Project, the U.S. National Science Foundation and National Institute of Health, the IAEA, as well as several private companies. Most of the genetic nurseries were grown at locations of the Montana and Idaho USA Agricultural Experiment Stations, and this work would not have been possible without great support from their helpful staffs.

BIBLIOGRAPHY

- Raboy, V. Seed phosphorus and the development of low-phytate crops, Inositol phosphates linking agriculture and the environment, (TURNER, B.L., RICHARDSON, A.E., Mullaney, E.J., Eds.), CABI, Oxfordshire, UK, 111-132 (2007).
- Lott, J.N.A. *et al.* Phytic acid and phosphorus in crop seeds and fruits: a global estimate. *Seed Sci. Res.* **10**, 11-33 (2000).
- Herring J.R., Fantel, R.J. Phosphate rock demand into the next century: impact on world food supply. *Nat. Resources Res.* **2**, 226-241 (1993).
- Volk, H. *et al.* Prospects for minimizing phosphorus excretion in ruminants by dietary manipulation. *J. Environ. Qual.* **29**, 28-36 (2000).
- Maguire, R.O. *et al.* Diet modification to reduce phosphorus surpluses: a mass balance approach. *J. Environ. Qual.* **36**, 1235-1240 (2007).
- Raboy, V. *et al.* Origin and seed phenotype of maize low phytic acid 1-1 and low phytic acid 2-1. *Plant Physiol.* **124**, 355-368 (2000).
- Shi, J. *et al.* The maize low phytic acid mutant *lpa2* is caused by mutation in an inositol phosphate kinase gene. *Plant Physiol.* **131**, 507-515 (2003).
- Shi, J. *et al.* The maize low-phytic acid 3 encodes a myo-inositol kinase that plays a role in phytic acid biosynthesis in developing seeds. *Plant J.* **42**, 708-719 (2005).
- Shi, J. *et al.* Embryo-specific silencing of a transporter reduces phytic acid content of maize and soybean seeds. *Nature Biotechnol.* **25**, 930-937 (2007).
- Pilu, R. *et al.* Phenotypic, genetic and molecular characterization of a maize low phytic acid mutant (*lpa241*). *Theor. Appl. Genet.* **107**, 980-987 (2003).
- Larson, S.R. *et al.* Linkage mapping of two mutations that reduce phytic acid content of barley grain. *Theor. Appl. Genet.* **97**, 141-146 (1998).
- Ockenden, I. *et al.* Characterization of the storage of phosphorus, inositol phosphate and cations in grain tissues of four barley (*Hordeum vulgare* L.) low phytic acid genotypes. *Plant Sci.* **167**, 1131-1142 (2004).
- Rasmussen, S., Hatzack, F. Identification of two low-phytate barley (*Hordeum vulgare* L.) grain mutants by TLC and genetic analysis. *Hereditas* **129**, 107-112 (1998).
- Roslinsky, V. *et al.* Molecular marker development and linkage analysis in three low phytic acid barley (*Hordeum vulgare*) mutant lines. *Mol. Breeding* **20**, 323-330 (2007).
- Cichy, K., Raboy, V. Evaluation and development of low-phytate crops, Modification of seed composition to promote health and nutrition, (Krishnan, H.K. , Ed.), American Society of Agronomy, *Crop Sci. Soc. Amer.*, Madison, WI., USA, 177-200 (2009)
- Larson, S.R. *et al.* Isolation and genetic mapping of a non-lethal rice (*Oryza sativa* L.) low phytic acid 1 mutation. *Crop Sci.* **40**, 1397-1405 (2000).
- Liu, Q.L. *et al.* Generation and characterization of low phytic acid germplasm in rice (*Oryza sativa* L.). *Theor. Appl. Genet.* **114**, 803-814 (2007).
- Kim, S.I. *et al.* The rice *OsLpa 1* gene encodes a novel protein involved in phytic acid metabolism. *Theor. Appl. Genet.* **117**, 769-779 (2008).
- Kim, S.I. *et al.* Isolation and characterization of a low phytic acid rice mutant reveals a mutation in the rice orthologue of maize *MIK*. *Theor. Appl. Genet.* **117**, 1291-1301 (2008).
- Zhao, H-J. *et al.* Gene identification and allele-specific marker development for two allelic low phytic acid mutations in rice (*Oryza sativa* L.). *Mol. Breeding* **22**, 603-612 (2008).
- Guttieri, M. *et al.* Identification and characterization of a low phytic acid wheat. *Crop Sci.* **44**, 418-424 (2004).
- Wilcox J.R. *et al.* Isolation of high seed inorganic P, low-phytate soybean mutants. *Crop Sci.* **40**, 1601-1605 (2000).
- Oltmans, S.E. *et al.* Inheritance of low-phytate phosphorus in soybean. *Crop Sci.* **44**, 433-435 (2004).
- Walker, D.R. *et al.* Genetic mapping of loci associated with seed phytic acid content in CX1834-1-2 soybean. *Crop Sci.* **46**, 390-397 (2006).
- Yuan, F.J. *et al.* Generation and characterization of two novel low phytate mutations in soybean (*Glycine max* L. Merr.). *Theor. Appl. Genet.* **115**, 945-957 (2007).
- Hitz, W. *et al.* Biochemical and molecular characterization of a mutation that confers a decreased raffinose and phytic acid phenotype on soybean seeds, *Plant Physiol.* **128**, 650-660 (2002).
- Stevenson-Paulik, J. *et al.* Generation of phytate-free seeds in *Arabidopsis* through disruption of inositol polyphosphate kinases. *PNAS* **102**, 12612-12617 (2005).
- Bregitzer, P. *et al.* Registration of ‘Herald’ Barley. *Crop Sci.* **47**, 441-442 (2007).
- Bregitzer, P. *et al.* Registration of ‘Clearwater’ low-phytate hullless spring barley. *J. Plant Registrations* **2**, 1-4 (2008).
- Meis, S.J. *et al.* Seed source effect on field emergence of soybean lines with reduced phytate and raffinose saccharides. *Crop Sci.* **43**, 1336-1339 (2003).
- Anderson, B.P., Fehr, W.R. Seed source affects field emergence of low-phytate soybean lines. *Crop Sci.* **48**, 929-932 (2008).
- Spear, J.D., Fehr, W.R. Genetic improvement of seedling emergence of soybean lines with low phytate. *Crop Sci.* **47**, 1354-1360 (2007).
- Bowen, D.E. A low phytic acid barley mutation alters seed gene expression. *Crop Sci.* **47**(S2), S149-S159 (2007).
- Mendoza, C. Effect of genetically modified, low-phytic acid maize on absorption of iron from tortillas. *Am. J. Clin. Nutrition* **68**, 1123-1127 (1998).

35. Hambidge, K.M. *et al.* 2004. Zinc absorption from low-phytate hybrids of maize and their wild-type isohybrids. *Am. J. Clin. Nutr.* **79**, 1053-1059 (2004).
36. Hambidge, K.M. *et al.* Absorption of calcium from tortilla meals prepared from low-phytate maize. *Am. J. Clin. Nutr.* **82**, 84-87 (2005).
37. Overturf, K. *et al.* Mineral availability from barley low phytic acid grains in rainbow trout (*Oncorhynchus mykiss*) diets. *Aquacul. Nutr.* **9**, 239-246 (2003).
38. Linares, L.B. *et al.* Effects of low phytate barley (*Hordeum vulgare* L.) on zinc utilization in young broiler chicks. *Poultry Sci.* **86**, 299-308 (2007).
39. Raghothama, K.G. Phosphate acquisition. *Annu. Rev. Plant Physiol. Plant Mol. Biol.* **50**, 665-693 (1999).
40. Bilyeu, K.D. Quantitative conversion of phytate to utilizable phosphorus in soybean seeds expressing a bacterial phytase. *Plant Physiol.* **146**, 468-477 (2008).
41. Warden, B.M., Russell, W.K. Resource allocation in a breeding programme for phosphorus concentration in maize grain. *Crop Sci.* **44**, 753-757 (2004).

Biosynthesis and Deposition of Seed Phytate and its Impact on Mineral Bioavailability

S K Rasmussen*, L Bohn, L Josefsen & A M Torp

Abstract

In cereal seeds, phosphorous is primarily deposited in protein storage vacuoles as phytic acid (PA) together with minerals. Even if the same core set of enzymes should exist throughout the plant kingdom, the organization of biosynthesis, translocation, site of accumulation and storage vary among species. PA accumulation in seeds begins shortly after flowering and lasts to seed maturity. During this period the growing plant may be challenged with changes in growth conditions, such as rain, drought, high temperature and pathogens. It has been shown that the individual inositol-phosphate-kinases, Ipk, accept a broad range of substrates and it is also evident that rice and barley Ipk have phosphatase and isomerase activity. These multiple activities provide more degrees of freedom for controlling, and fine tuning, PA biosynthesis during seed development. Isolated phytate globoids from rice and wheat bran have been characterized and K>Mg>Ca>Fe were found as the main minerals. While iron co-purifies with PA in the globoids, this is less evident for zinc, and although copper has high affinity for PA, there is no indication that copper-phytate globoids are the primary storage facility for this element. This difference in seed distribution of iron and zinc must be taken into account in breeding strategies for improving mineral content. The dephosphorylation patterns of pure PA and phytate globoids by wheat phytase have been established, and the kinetics of phytase with either PA or phytate globoids as substrates have been compared. The bioavailability of iron in phytate globoids has been studied using caco-2 cells. PA is an important anti-nutritional factor in the diet of humans because it reduces the bioavailability of iron and zinc. The way food is prepared may solve these problems associated with PA, through the action of endogenous phytases. In addition, low-PA seeds can potentially reduce problems with P management in animal husbandry. Mutational breeding provides a useful way of creating genetic diversity for both PA and mineral bioavailability in cereals.

Introduction

Nutrition, environment and resources

Phytic acid (PA; *myo*-inositol 1,2,3,4,5,6,-hexakisphosphate) is the primary storage compound of phosphorus in plant seeds accounting for up to 80% of the total seed phosphorus and contributing as much as 1.5% to the seed dry weight [1]. Stored PA has an impact on the supply of phosphate and the bioavailability of iron (Fe), zinc (Zn) and other minerals to animals. It has also been implicated in many cellular processes including cancer development. In human nutrition, PA acts as an anti-nutritional factor for, in particular, iron and zinc uptake in the digestive tract, and thus potentially contributes to the 'hidden hunger' of mineral malnutrition. However, PA may also have positive effects on human health, as it has been suggested that PA has anti-carcinogenic effects and the anti-oxidative ability of PA may balance iron ions in solution [2]. **Table 1** shows the wide range of metabolic processes

with PA involvement. In animal husbandry, the main problem caused by PA in grain is that phosphate bound in phytic acid cannot be digested by monogastric animals. Thus, phosphate must be supplemented or the enzyme phytase must be added to the feed as a pretreatment. This has an impact on the environment since phosphate and PA-bound phosphorous are released into the fields and can eventually enter the near coastal sea areas, lakes and fresh water streams, leading to eutrophication. Finally, a major concern is phosphorus as resource, as it is believed that high-quality rock phosphorous will be exhausted within this century.

Table 1. Involvement of phytic acid in cellular processes

Cancer therapy	Gene regulation	Starch digestibility
Cell differentiation	Efficient export of mRNA	Blood glucose response
Apoptosis	RNA-editing	Prevention of dystrophic calcifications
Immune function	Oocyte maturation	Kidney stone formation
Antioxidant	Cell division and differentiation	Lowering cholesterol
Oncogene regulation	DNA repair	Lowering triglycerides
Regulation of Phase I & II enzymes	Cell signalling cascades	Inhibit transcript of HIV-1 genome
Cell proliferation	Ca ²⁺ mobilisation and signalling	Prevent plaque formation on teeth
Tumor metastasis	Protein folding and trafficking	
Angiogenesis		
Inflammation		
Controlling iron-related oxidative stress, important for men over 20 years	Endo- and exocytosis	

Solutions to the phytic acid in feed

Improving crop plants for feedstuff has obtained most attention, and as natural variation in grain PA content is known to exist, mutational breeding has been an attractive strategy to reduce grain PA content. Many low-phytic acid (*Ipa*) mutants have been identified in barley, maize, rice, wheat and soybean [3-8]. These were all identified by an indirect screening procedure based on the assumption that total phosphorus remains constant in the seed, but the distribution between free phosphate and that bound in phytic acid can be modulated. An alternative strategy has been the production of GM crop plants that overproduce a microbial phytase in grain, which can be utilized directly in the feedstuff or added during industrial feed production. However, the most successful solution for the reduction of PA in feed is still the addition of microbial enzymes (phytases) directly to the feed.

Biosynthesis of phytic acid

Significant progress in defining the PA biosynthetic pathways has been made in recent years, and the importance of induced mutations in revealing controlling steps can not be overestimated. Recently, a number of plant genes involved in the pathway have been cloned and characterized. **Table 2** summarizes those originating from the cereals, maize, rice

Department of Agriculture and Ecology, Molecular Plant Breeding, University of Copenhagen, Denmark

* Corresponding author. E-mail: skr@life.ku.dk

and barley. The *myo*-inositol monophosphate synthase gene has been identified in several plant species [9-11]. The encoded protein converts glucose-6-phosphate to inositol-3-phosphate. This appears to be the first committed step in a sequential phosphorylation of *myo*-inositol to PA and provides the only source of the inositol ring. An inositol kinase that produces inositol monophosphates from inositol, and which is required for normal PA accumulation, has been cloned in maize (*Zea mays*) [12]. An inositol polyphosphate kinase has been characterized in maize [13] and *Arabidopsis thaliana* [14], and most recently, two genes involved in late phosphorylation steps to PA, have been cloned and characterized in *Arabidopsis* [15-18]. A detailed characterization of a multifunctional inositol phosphate kinase from rice and barley belonging to the ATP-grasp superfamily show the highest activity towards Ins (3,4,5,6)P₄, which is likely the primary substrate [19]. Based on the cloned genes, combined with the knowledge from mammalian and yeast systems, several pathways to PA have been suggested to exist in plants, however, these still need to be experimentally confirmed.

In addition to kinases and synthases, unexpected genes have been found to be involved in the accumulation of PA during seed development. This includes an ABC-transporter [20] from maize and rice and 2-phosphoglycerate kinase from rice [21, 22]. This shows that random mutations may help us to uncover as yet unknown controlling steps in PA metabolism and sequestration.

Enzyme	Species	Gene	Accession No ¹	References
<i>Myo</i> -inositol-1 phosphate synthase (MIPS)	Rice	<i>RINO1</i> ²	AB012107 LOC_Os03g09250	[10, 29]
	Rice	<i>RINO2</i>	AK069323 LOC_Os10g22450	[31]
	Barley	<i>MIPS</i>	AF056325	[9]
	Maize	<i>MIPS</i> ³	AF056326	[9]
Inositol monophosphatase (IMP)	Rice	<i>OsIMP-1</i>	AK071149 LOC_Os03g39000	[31]
	Rice	<i>OsIMP-2</i>	AK103039 LOC_Os02g07350	[31]
	Barley	<i>HvIMP-1</i>	AY460570	[33]
<i>Myo</i> -inositol kinase (MIK)	Maize	<i>ZmLpa3</i> ^{2,4}	AY772410	[12]
	Rice	<i>OsMIK</i> ²	AC118133 LOC_Os03g52760	[12, 28]
Inositol 1,4,5-tris-phosphate kinase (IPK2)	Rice	<i>OsIPK</i> ⁵	AK072296 LOC_Os02g32370	[31]
Inositol 1,3,4,5,6-pentakis-phosphate 2-kinase (IPK1)	Rice	<i>OsIPK1</i> ⁵	AK102842 LOC_Os04g56580	[31]
	Maize	<i>ZmIPK1A</i> ⁴	EF447274	[30]
	Maize	<i>ZmIPK1B</i>	EF527875	[30]
Inositol 1,3,4-tri-kisphosphate 5/6-kinase (ITP5/6K)	Maize	<i>ZmIPK</i> ^{2,4}	AY172635	[13]
	Rice	<i>OsIPK</i> ^{4,6}	NP922861 LOC_Os10g42550	[19]
	Barley	<i>HvIPK</i> ⁴	AM404177	[19]
	Rice	<i>OsITP5/6K-1</i>	AK106544 LOC_Os10g01480	[31]
	Rice	<i>OsITP5/6K-2</i>	AK100971 LOC_Os03g12840	[31]
	Rice	<i>OsITP5/6K-3</i>	AK067068 LOC_Os03g51610	[31]
	Rice	<i>OsITP5/6K-4</i>	AK071209 LOC_Os02g26720	[31]
	Rice	<i>OsITP5/6K-5</i>	AK059148 LOC_Os10g42550	[31]
Rice	<i>OsITP5/6K-6</i>	AK102571 LOC_Os09g34300	[31]	
ABC-transporter (MRP)	Maize	<i>ZmMRP4</i> ²	EF586878	[20]
	Rice	<i>OsMRP13</i>	Os03g04920	[20]
2-Phosphoglycerate kinase (2PGK)	Rice	<i>Os2PGK</i> ²	LOC_Os02g57400	[21, 22]
	Rice	<i>Os2PGK</i>	LOC_Os09g39870	[21]

Table 2. Cloned genes involved in the biosynthesis and accumulation of phytic acid in cereals

(1) Genebank accession number (nucleotide) and TIGR locus identifier (for rice genes); (2) Mutants or transgenic antisense plants for the gene show *lpa* phenotype; (3) Map location of cloned gene corresponds with that of a *lpa* mutant; (4) Recombinant protein show kinase activity; (5) Positive complementation test in yeast lacking the corresponding gene; (6) *OsIPK* [19] and *OsITP5/6K-5* [31] are likely to be the same gene.

Phytic acid globoids and mineral content

Phytic acid accumulates during seed development in electron-dense particles named globoids, which also store minerals. These globoids were purified from wheat bran and the content of minerals quantified by inductively coupled plasma-mass spectrometry [23]. The main elements, in concentration order, were K>Mg>Ca>Fe and although copper has high affinity for PA there is no indication that globoids are the main store for this element. Interestingly, whereas iron co-purifies with phytic acid globoids, this was not found for zinc, which is in agreement with the notion that zinc is stored in other compartments of the developing seed.

Degradation of phytic acid

The stored phosphorus in PA is believed to be remobilized during germination to provide phosphorus to the emerging seedling. Some plant species store phytases in the resting grain, ready to initiate dephosphorylation of phytic acid. Phytases have been purified and characterized from seven cereals and 16 other plant species [2]. Phytases are specialized phosphatases [24,25] that utilize phytic acid as substrate. In a detailed biochemical study, wheat bran phytase was shown to initiate at the C6 and C3 positions of the inositol ring [23]. It is noteworthy that the subsequent dephosphorylation of inositol-phosphate is ordered and sequential. It is not random.

Phytic acid and bioavailability of iron

CaCo-2 cells provide an ideal way of elucidating a simple picture of the interactions between phytase and its substrate to investigate iron bioavailability in globoids. The natural PA: iron ratio of wheat globoids is 51:1, and a ratio lower than 27:1 is required for significant iron bioavailability (Bohn, unpublished results). Results from other investigations of this phenomenon have revealed a threshold of 5:1 for PA: Fe²⁺ complexes [26] and 10:1 using pure PA: Fe³⁺ complexes [27]. The bioavailability of Fe at a ratio of 12:1 from globoids suggests that factors that increase iron absorption are present in the solution. Pepsin degradation of the proteins may reveal peptides as weak chelators to maintain iron solubility. Furthermore, as PA has stronger binding to other minerals, such as copper, zinc and manganese, these cations could be binding competitively to the PA, thereby leaving iron free for absorption. Some of these cations do, however, also inhibit iron uptake by the intestines, and the impact of their binding to either PA or the DMT1-transporter remains unknown. Taking these results further would involve the investigating of the bioavailability of other minerals from globoids, such as zinc or calcium, in CaCo-2 cells whilst altering PA concentrations. Once the bioavailability of the elements in globoids are understood, similar experiments could be performed using bran or whole-wheat bread, to explore the inhibition of mineral uptake by fibers, cell walls, starch etc. This would provide information on the optimal treatment of cereals to improve the uptake of minerals from them without depleting PA completely.

ACKNOWLEDGEMENTS

This project was supported by the Danish Research Council for Technology and Production Sciences, The Danish Council for Strategic Research and HarvestPlus.

BIBLIOGRAPHY

- Lott, J.N.A. Accumulation of Seed Reserves of Phosphorous and Other Minerals, *Seed Physiology*, Academic Press, Sydney, Australia, p.139-166 (1984).
- Bohn, L., Meyer, A., Rasmussen, S.K. Phytate: Impact on environment and human nutrition. A challenge for molecular breeding. *J. Zhejiang Uni Sci* **B9**, 165-191 (2008).
- Rasmussen, S.K. and Hatzack, F. Identification of two low-phytate barley (*Hordeum vulgare* L.) grain mutants by TLC and genetic analysis. *Hereditas* **129**, 107-113 (1998).
- Larson, S.R., Rutger, J.N., Young, K.A., Raboy, V. Isolation and genetic mapping of a non-lethal rice (*Oryza sativa* L.) low phytic acid 1 mutation. *Crop Sci.* **40**, 1397-1405 (2000).

5. Raboy, V. *et al.* Origin and seed phenotype of maize low phytic acid 1-1 and low phytic acid 2-1. *Plant Physiol.* **124**, 355–368 (2000).
6. Wilcox, J.R., Premachandra, G.S., Young, K.A., Raboy, V. Isolation of high seed inorganic P, low-phytate soybean mutants. *Crop Sci.* **40**, 1601–1605 (2000).
7. Pilu, R., Panzeri, D., Gavazzi, G., Rasmussen, S.K., Consonni, G., Nielsen, E. Phenotypic, genetic and molecular characterization of a maize low phytic acid mutant (lpa241). *Theor. Appl. Genet.* **107**, 980–987 (2003).
8. Guttieri, M., Bowen, D., Dorsch, J.A., Raboy, V., Souza, E. Identification and characterization of a low phytic acid wheat. *Crop Sci.* **44**, 418–424 (2004).
9. Larson, S.R., Raboy, V. Linkage mapping of maize and barley myoinositol 1-phosphate synthase DNA sequences: correspondence with a low phytic acid mutation. *Theor. Appl. Genet.* **99**, 27–36 (1999).
10. Yoshida, K.T., Wada, T., Koyama, H., Mizobuchi-Fukuoka, R., Naito, S. Temporal and spatial patterns of accumulation of the transcript of myoinositol-1-phosphate synthase and phytin-containing particles during seed development in rice. *Plant Physiol.* **119**, 65–72 (1999).
11. Hegeman, C.E., Good, L.L., Grabau, E.A. Expression of D-myo-inositol-3-phosphate synthase in soybean. Implications for phytic acid biosynthesis. *Plant Physiol.* **125**, 1941–1948 (2001).
12. Shi J., Wang, H., Hazebroek, J., Ertl D.S., Harp T. The maize low-phytic acid 3 encodes a myo-inositol kinase that plays a role in phytic acid biosynthesis in developing seeds. *Plant J.* **42**, 708–719 (2005).
13. Shi J., Wang, H., Wu, Y., Hazebroek, J., Meeley R.B., Ertl D.S. The maize low-phytic acid mutant *lpa2* is caused by mutation in the inositol phosphate kinase gene. *Plant Physiol* **131**, 507-515 (2003).
14. Wilson, M.P., Majerus, P.W. Characterization of a cDNA encoding *Arabidopsis thaliana* inositol 1,3,4-trisphosphate 5/6-kinase. *Biochem. Biophys. Res. Commun.* **232**, 678–681 (1997).
15. Stevenson-Paulik, J., Odom, A.R., York, J.D. Molecular and biochemical characterization of two plant inositol polyphosphate 6-/3-/5-kinases. *J. Biol. Chem.* **277**, 42711–42718 (2002).
16. Xia, H.J., Brearley, C., Elge, S., Kaplan, B., Fromm, H., Mueller-Roeber, B. *Arabidopsis* inositol polyphosphate 6-/3-kinase is a nuclear protein that complements a yeast mutant lacking a functional ArgR-Mcm1 transcription complex. *Plant Cell* **15**, 449–463 (2003).
17. Stevenson-Paulik, J., Bastidas, R.J., Chiou, S.T., Frye, R.A., York, J.D. Generation of phytate-free seeds in *Arabidopsis* through disruption of inositol polyphosphate kinases. *Proc. Natl. Acad. Sci. U.S.A.* **102**, 12612–12617 (2005).
18. Sweetman, D., Johnson, S., Caddick, S.E.K., Hanke, D.E., Brearley, C.A. Characterization of an *Arabidopsis* inositol 1,3,4,5,6-pentakisphosphate 2- kinase (AtIPK1). *Biochem. J.* **394**, 95–103 (2006).
19. Josefsen L., Bohn, L., Sørensen M.B., Rasmussen S.K. Characterization of a multifunctional inositol phosphate kinase from rice and barley belonging to the ATP-grasp superfamily. *Gene* **397**, 114-125 (2007).
20. Shi, J., Wang, H., Schellin, K., Li, B., Faller, M., Stoop, J.M., Meeley, R.B., Ertl, D.S., Ranch J.P., Glassman K. Embryo-specific silencing of a transporter reduces phytic acid content of maize and soybean seeds. *Nature Biotechnology* **25**, 930-937 (2007).
21. Kim S.I., Andaya, C.B., Goyal, S.S., Tai T.H. The rice *OsLpa1* gene encodes a novel protein involved in phytic acid metabolism. *Theor. Appl. Genet.* **117**, 769-779 (2008a).
22. Zhao H.J., Liu, Q.L., Ren, X.L., Wu D.X., Shu Q.Y. Gene identification and allele-specific marker development for two allelic low phytic acid mutations in rice (*Oryza sativa* L.). *Mol. Breed.* **22**, 603-612 (2008).
23. Bohn, L., Josefsen, L., Meyer, A., Rasmussen S.K. Quantitative analysis of phytate globoids isolated from wheat bran and characterization of their sequential dephosphorylation by wheat phytase. *J. Agric. Food Chem.* **55**, 7547-7552 (2007).
24. Hatzack, F., Brinch-Pedersen, H. Analysis of Phosphorus and Phosphorylated Compounds in the Context of Plant Physiology and Global Phosphorus Management: A Review. *Cur Analyt Chem* **2**, 421-430 (2006).
25. Rasmussen, S.K., Johansen, K.S. Sørensen, M.B. Polynucleotides encoding Phytase polypeptides. US patent 7.186.817-2007 (2000).
26. Engle-Stone, R., Yeung, A., Welch, R., Glahn, R. Meat and ascorbic acid can promote iron availability from Fe-phytate but not from Fe-tannic acid complexes. *J Agric Food Chem* **53**, 10276-10284 (2005).
27. Glahn, R.P., Wortley, G.M., South, P.K., Miller, D.D. Inhibition of iron uptake by phytic acid, tannic acid, and ZnCl₂: Studies using an *in vitro* digestion/Caco-2 cell model. *J Agric Food Chem* **50**, 390-395 (2002).
28. Kim S.I., Andaya, C.B., Newman, J.W., Goyal, S.S., Tai T.H. Isolation and characterization of a low phytic acid rice mutant reveals a mutation in the rice orthologue of maize *MIK*. *Theor. Appl. Genet.* **117**, 1291-1301 (2008b).
29. Kuwano M., Mimura, T., Takaiwa, F., Yoshida K.T. Generation of stable 'low phytic acid' transgenic rice through antisense repression of the 1D-myo-inositol 3-phosphate synthase gene (RIN01) using the 18-kDa oleosin promoter. *Plant Biotech J* DOI: 10.1111/j.1467-7652.2008.00375.x (2008).
30. Sun Y., Thompson, M., Lin, G., Butler, H., Gao, Z., Thornburgh, S., Yau, K., Smith, D.A., Shukla V.K. Inositol 1,3,4,5,6-Pentakisphosphate 2-Kinase from maize: Molecular and biochemical characterization. *Plant Physiol.* **144**, 1278-1291 (2007).
31. Suzukin M., Tanaka, K., Kuwano, M., Yoshida K.T. Expression pattern of inositol phosphate-related enzymes in rice (*Oryza sativa* L.): Implications for the phytic acid biosynthetic pathway. *Gene* **405**, 55-64 (2007).
32. Fu J., Peterson, K., Guttieri, M., Souza, E., Raboy, V. Barley (*Hordeum vulgare* L) inositol monophosphatase: gene structure and enzyme characteristics. *Plant. Mol. Biol.* **67**, 629-642 (2008).

Revealing the Complex System of Starch Biosynthesis in Higher Plants Using Rice Mutants and Transformants

Y Nakamura^{1,*}, N Fujita¹, Y Utsumi¹, A Nishi² & H Satoh²

Abstract

Starch is the end product of photosynthesis and a primary material for food and industrial uses. Starch has a variety of distinct physico-chemical properties such as gelatinization and pasting properties, and these features are strongly related to the molecular structure of amylopectin and the formation of starch granules, whose morphology depends on the plant species. The multi-dimensional, unique structure of starch is achieved by concerted reactions catalyzed by multiple isoforms of a set of enzymes that include starch synthase, starch branching enzyme and starch debranching enzyme. The action mechanism of each of these isoforms is currently being studied. This paper summarizes recent results of biochemical and genetic analyses of starch biosynthesis in rice endosperm obtained from various mutants and transformants, and discusses ideas about the regulation of starch biosynthesis in plants.

Starch is glucose polymer with two α -glucosidic linkages, linearly linked α -1,4-glucosidic chains are branched by α -1,4-glucosidic linkages, and it comprises linear or rarely branched amylose and highly branched amylopectin. Amylopectin has a distinct highly ordered structure called a “tandem-cluster structure,” in which most of side chains are arranged in parallel and neighboring chains form double helices when linear portions of facing chains reach the length equivalent to degree of polymerization (DP) ≥ 10 . The formation of double helices in the amylopectin cluster dramatically induces its hydrophobicity and crystallinity. These specific features of amylopectin fine structure are enabled by the localization of branch positions within the restricted region of the cluster. The starch synthesis system has developed during the evolution of plants and key enzymes involved in the construction of amylopectin tandem-cluster structure have differentiated into multiple isoforms with distinct functions, whereas in glycogen synthesizing organisms, such as bacteria and animals, no such functional differentiation in glycogen synthesis enzymes has occurred (Fig. 1, [1-5]).

Starch branching enzyme (BE) plays a very important part in the formation of branches in amylopectin molecules. Green plants are known to have two types of BE isoforms, BEI and BEII. In addition, BEII is further differentiated into BEIIa and BEIIb isoforms in cereals although BEIIb is usually specifically expressed in endosperm while BEIIa is ubiquitously present in every tissue. Our biochemical studies of three mutants of rice that are defective in BEI, BEIIa, and BEIIb, respectively, strongly suggest that the role of BEIIb is highly specific in synthesizing branches located on the basal portion of the crystal zone (referred to as the crystal lamellae) of the cluster because BEI and BEIIa can hardly complement its role in its absence (Fig. 2, [1, 6, 7]). On the other hand, BEI plays an important role in forming branches that are positioned at the basal part of the cluster in the less crystalline zone (referred to as the amorphous lamellae), and those which link the clusters, but its role can be largely complemented by BEIIb and BEIIa in the BEI mutant [1, 8].

¹ Faculty of Bioresource Sciences, Akita Prefectural University, Shimoshinjo-Nakano, Akita-City, 010-0195, Japan

² Institute of Genetic Resources, Kyushu University, Hakozaki, Fukuoka, 812-8581, Japan

* Corresponding author. E-mail: nakayn@akita-pu.ac.jp

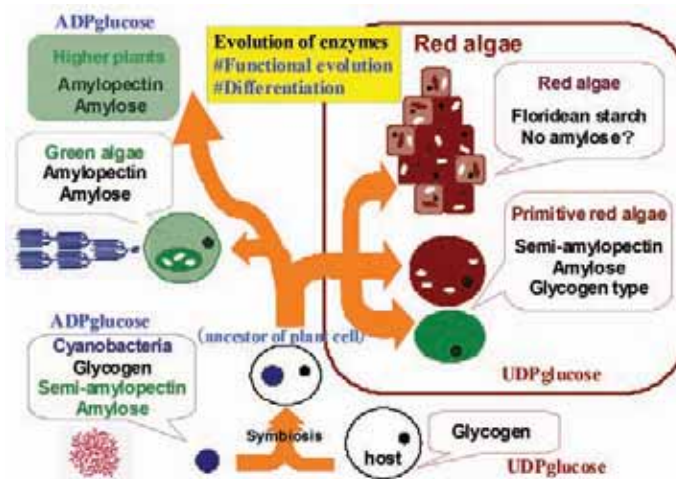

Figure 1 Schematic representation of the structure and synthesis of α -glucans during plant evolution. It is noted that ADP glucose is used in cyanobacteria, green algae and higher plants as precursor of glucans, while UDP glucose is used in red algae. During the evolution of starch biosynthesis, enzymes are thought to have evolved functionally and the number of isoforms to have increased.

Although the activity of BEIIa accounts for about 20% of the total BE activity in rice endosperm [9], the specificity of its function is likely to be poor because no significant changes in the structure of amylopectin and the physicochemical properties of starch granules are found in the BEIIa mutant [1, Nishi, *et al.*, unpublished data]. This data indicates that the branches within the cluster can be divided into at least two groups which are distinguished by different BE isoforms.

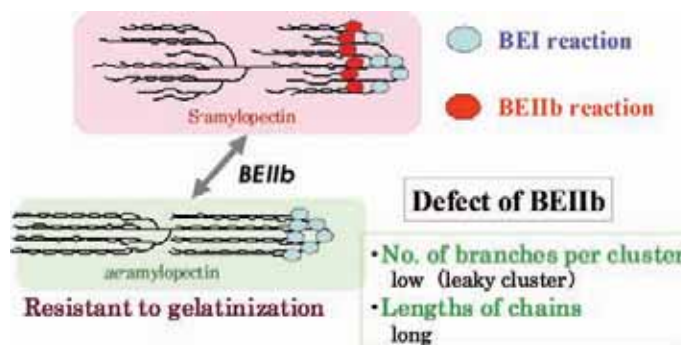

Figure 2 The schematic representation of distinct functions of BEI and BEIIb isoforms present in rice endosperm. It is noted that this scheme can explain why ae-amylopectin can be formed in the absence of BEIIb.

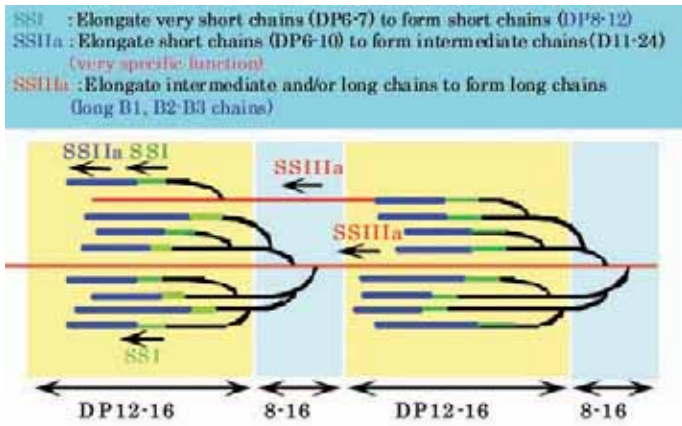

Figure 3 The schematic representation of distinct functions of three SS isozymes in rice endosperm. The figure shows that the synthesis of amylopectin cluster can be performed by concerted reactions of SSI, SSIIa and SSIIIa.

Rice has three major starch synthase (SS) isozymes, SSI [1, 10], SSIIa [1, 11] and SSIIIa [1, 12] in developing endosperm. We recently determined the distinct properties of each isozyme; SSI, SSIIa, and SSIIIa are responsible for the synthesis of very short chains with DP~8-12, intermediate chains with DP≤~24, and long chains with DP~20, respectively (Fig. 3). Since each SS isozyme is thought to recognize the chain-length from the non-reducing end to the branch point of the α-1,4-chains and elongates it until its range is exceeded, the maximal length to which each SS isozyme can elongate the chain is strictly restricted and differs between isozymes. This feature might be important for each cluster to obtain a fixed length of DP27-28.

Starch debranching enzyme (DBE) plays an essential role in the synthesis of the amylopectin cluster by trimming the shape of the cluster, because in its absence amylopectin is replaced by phytoglycogen [1, 13]. Plants have two DBE-types, isoamylase (ISA) and pullulanase (PUL), and generally three ISA isozymes (ISA1, ISA2 and ISA3) and one PUL isoform. ISA activity involved in starch biosynthesis is due to the ISA1-ISA2 hetero-oligomer in potato tuber and Arabidopsis leaves [14], while the endosperm of rice and maize contains both the ISA1 homo-oligomer and the hetero-oligomer [15]. Although the details of how DBEs are involved in the synthesis of amylopectin are unknown, it is thought that these enzymes remove improper branches that interfere with the formation of double helices [1] and accelerate the crystallization of the cluster [16].

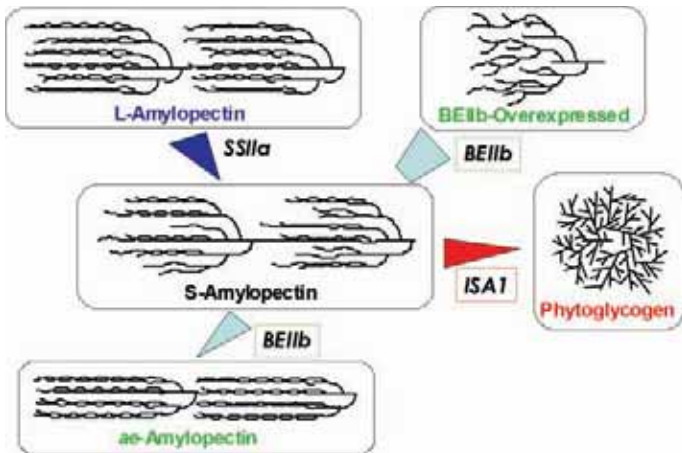

Figure 4 Schematic representation of changes in the amylopectin cluster structure induced by different levels of key enzyme isoforms (cluster-world). Note that the type of the cluster structure is determined by the enzyme activity of the individual enzyme isoform.

Detailed analyses of changes in the structure of amylopectin and the physicochemical properties of starch granules in rice endosperm caused by the absence of each isoform of BE, SS and DBE, have established that individual mutants exhibit distinct characteristics in terms of the starch structure and properties depending on the enzyme activities inhibited. These patterns reflect the specific functions of each enzyme in starch biosynthesis in rice endosperm and enable us to predict how, and to what extent the structure and properties of starch can be engineered by manipulating the genes encoding starch-synthesizing enzymes (Fig. 4). Our results suggest that numerous rice mutant lines could be used for industrial purposes in the future by producing novel starches in the endosperm.

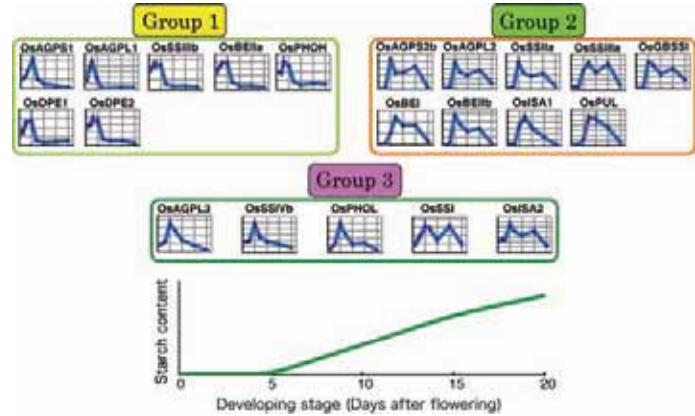

Figure 5 The pattern of changes in transcript levels of starch synthesizing genes during endosperm development of rice. Group 3 genes are expressed from the early stages to the latter stage.

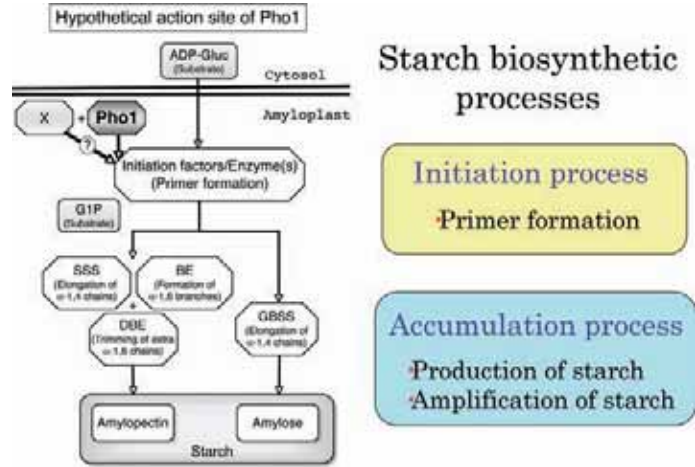

Figure 6 The schematic representation of the two distinct processes of starch biosynthesis and the possible role of Pho1 in rice endosperm. We assume that Pho1 plays a crucial role in the initiation process by synthesizing primers of amylopectin molecules and/or starch granules.

Transcriptome analysis has established that changes in transcript levels of genes encoding starch-synthesizing enzymes in rice endosperm can be divided into three temporal patterns [17]. One group of genes (Group 1 in Fig. 5) are highly expressed in the very early stages of endosperm development (days after pollination, DAP, up to about five days) prior to the onset of rapid starch production, whereas the other group genes (Group 2 in Fig. 5) are expressed more when starch accumulation in the endosperm is at its greatest (Fig. 5).

Recent studies using rice mutants lacking plastidic glucan phosphorylase (Pho1) showed that the loss of Pho1 resulted in a severe reduction

in starch accumulation in some seeds, while other seeds have plumped shape, suggesting that Pho1 plays a crucial role in the initial stage of starch biosynthesis such as initiation of glucan molecules and starch granules [18].

These results strongly suggest that starch biosynthesis is composed of two distinct processes, namely the initiation process of starch biosynthesis, in which glucan primers are synthesized and/or the initial core of starch granules are formed, and the accumulation and/or amplification process, in which the number of starch molecules and starch granule are amplified, and that these processes are regulated by different mechanisms and include different sets of enzyme isozymes (Fig. 6).

BIBLIOGRAPHY

- Nakamura, Y. Towards a better understanding of the metabolic system for amylopectin biosynthesis in plants. *Plant Cell Physiol.* **43**, 718-725 (2002).
- Ball, S.G., Morell, M.K. From bacterial glycogen to starch: understanding the biosynthesis of the plant starch granule. *Annu. Rev. Plant Biol.* **54**, 207-233 (2003).
- Nakamura, Y. *et al.* Some cyanobacteria synthesize semi-amylopectin type α -polyglucans instead of glycogen. *Plant Cell Physiol.* **46**, 539-545 (2005).
- Deschamps, P. *et al.* Metabolic symbiosis and the birth of the plant kingdom. *Mol. Biol. Evol.* **25** (2007)
- Shimonaga, T. *et al.* Variation in storage α -glucans of Porphyridiales (*Rhodophyta*). *Plant Cell Physiol.* **49**, 103-116 (2008).
- Nishi, A. *et al.* Biochemical and genetic analysis of the effects of amylose-extender mutation in rice endosperm. *Plant Physiol.* **127**, 459-472 (2001).
- Tanaka, N. The structure of starch can be manipulated by changing the expression levels of starch branching enzyme IIb in rice endosperm. *Plant Biotech. J.* **2**, 507-516 (2004).
- Satoh, H. *et al.* Starch-branching enzyme I-deficient mutation specifically affects the structure and properties of starch in rice endosperm. *Plant Physiol.* **133**, 1111-1121 (2003).
- Yamanouchi, H., Nakamura, Y. Organ specificity of isoforms of starch branching enzyme (Q-enzyme) in rice. *Plant Cell Physiol.* **33**, 985-991 (1992).
- Fujita, N. *et al.* Function and characterization of starch synthase I using mutants in rice. *Plant Physiol.* **140**, 1070-1084 (2006).
- Nakamura, Y. *et al.* Essential amino acids of starch synthase IIa differentiate amylopectin structure and starch quality between *japonica* and *indica* rice varieties. *Plant Mol. Biol.* **58**, 213-227 (2005).
- Fujita, N. *et al.* Characterization of SSIIIa-deficient mutants of rice: The function of SSIIIa and pleiotropic effects by SSIIIa deficiency in the rice endosperm. *Plant Physiol.* **144**, 2009-2023 (2007).
- Kubo, A. *et al.* Complementation of *sugary-1* phenotype in rice endosperm with the wheat Isoamylase1 gene supports a direct role for isoamylase1 in amylopectin biosynthesis. *Plant Physiol.* **137**, 43-56 (2005).
- Hussain, H. *et al.* Three isoforms of isoamylase contribute different catalytic properties for the debranching of potato glucans. *Plant Cell* **15**, 133-149 (2003).
- Utsumi, Y., Nakamura, Y. Structure and enzymatic characterization of the isoamylase1 homo-oligomer and the isoamylase1-isoamylase2 hetero-oligomer from rice endosperm. *Planta* **225**, 75-87 (2006).
- Myers, A.M. *et al.* Recent progress toward understanding biosynthesis of the amylopectin crystal. *Plant Physiol.* **122**, 989-999 (2000).
- Ohdan, T. *et al.* Expression profiling of genes involved in starch synthesis in sink and source organs of rice. *J. Exp. Bot.* **56**, 3229-3244 (2005).
- Satoh, H. *et al.* Plastidic α -glucan phosphorylase mutation dramatically affects the synthesis and structure of starch in rice endosperm. *Plant Cell* **20**, 1833-1849 (2008).

Mutants Pave the Way to Wheat and Barley for Celiac Patients and Dietary Health

D von Wettstein

Abstract

Wheat has two major nutritional problems for the consumer: (1) The flour or pasta produced from the grain is not acceptable to congenital celiac patients and may induce intolerance of dietary “gluten” in people later in life. (2) The grain is highly deficient in the essential amino acid lysine. Currently there is only one treatment for sufferers of celiac disease: the complete exclusion of wheat, barley and rye grains from their diets. Celiac disease is caused by an autoimmune reaction against undigested proline/glutamine rich peptides (epitopes) that are taken up through the intestinal mucosa and initiate an autoimmune response in human leucocyte antigen DQ2- or DQ8-positive individuals. This leads to chronic erasure of the microvilli of the intestinal epithelium and to permanent intolerance of dietary “gluten.” Cereal prolamins are of two types: high molecular weight glutenins (HMWG) with a molecular structure of elastic fibrils that form dityrosine cross-links during dough formation and baking, and gliadins. The gene promoters of the gliadin-type proteins are silenced by DNA methylation in vegetative tissues. This methylation is removed during grain development to permit protein synthesis. Inhibition of the demethylation by mutation specifically inhibits the synthesis of the gliadin-type proteins and only proteins consisting of elastic fibrils are produced. As a proof of principle, a barley cultivar called *Lysiba* already exists that has such a mutation and provides the rationale for creating wheat varieties by mutation of the 5-methylcytosine deglycosylases in the endosperm. Celiac patients are sensitive to a wide variety of different epitopes, which are located in the gliadin-type prolamins. Gliadin-type prolamins are of no importance for baking because wheat HMW glutenin has been shown to be alone sufficient to produce high quality breads.

Introduction

Celiac disease is the most common food-sensitive enteropathological condition in humans and it is caused by an autoimmune reaction against certain wheat, barley and rye grain storage proteins. In human leukocyte antigen (HLA) DQ2- (or DQ8-) positive individuals' exposure to these “gluten” proteins can lead to a painful chronic erasure of the microvilli of the epithelium in the intestine and to a permanent intolerance of dietary prolamins. The autoimmune response results from the resistance to digestion of certain proline/glutamine-rich peptides (epitopes) in the prolamins by gastric, pancreatic and brushborder membrane proteases. Peptides like PFPQPQLPY are taken up through the intestinal mucosa into the *lamina propria* and initiate the autoimmune response [1]. Celiac disease is commonly detected in congenital cases with severe symptoms in early childhood. In an increasing number of patients, symptoms arise only later in life as a result of bread and pasta consumption. If untreated, celiac disease may cause increased morbidity and mortality. Despite its prevalence in most populations comprising 24.4 million registered celiac

individuals world-wide [2], the only effective therapy is strict dietary abstinence from these food grains [3]. However, because of the multiple presentations of the disease, many sufferers of this disease have not been formally diagnosed with it and estimates suggest that for every registered celiac there are 50 unrecognized individuals.

Our aim is to eliminate the prolamins from wheat grain that contain the majority of epitopes causing celiac disease. Eliminating these proteins will also address the other major quality problem for the consumer of wheat products: the imbalance in the amino acid profile of wheat proteins. Wheat grain is especially low in lysine which is the most limiting amino acid in cereal proteins for humans and monogastric animals. Because the prolamins protein families we are targeting are very lysine poor, their elimination will lead to a considerable increase in grain lysine content with concomitant improved nutritional quality, which will be beneficial for all consumers of wheat products. The highly homologous storage proteins of wheat, barley and rye called prolamins fall into two groups: one group, represented by the lysine poor gliadins and low molecular weight (LMW) glutenins of wheat, contain the overwhelming majority of the protein domains (epitopes) causing the celiac response and are dispensable for baking, and can therefore, be removed. The other group represented by the wheat high molecular weight (HMW) glutenins are alone required for dough formation and baking, and therefore must be retained. The molecular structure of these two types of prolamins is very different and their genes are turned on and off by two fundamentally different mechanisms, which provides the strategy for elimination of the gliadins and LMW glutenins but preservation of the HMW glutenins. The genes for gliadins and LMW glutenins are silenced by DNA methylation of their promoters in vegetative tissues. The promoters have to be de-methylated at the beginning of endosperm development to permit their transcription and the synthesis of the encoded prolamins. The aim is to silence these genes permanently in the endosperm by mutations in the enzymes carrying out the demethylation. A fully viable mutant with these characteristics has been obtained in barley. The six wheat genes encoding the elastic fibrils of the HMW glutenins that form dityrosine cross-links during dough formation and baking and pasta production are protected against DNA methylation in all tissues by a CpG island in their promoter. They are turned on by synthesis of transcription factors or removal of repressor proteins at the beginning of grain filling.

Preliminary studies

Only HMW glutenin is required for baking

Ingo Bauer [4] has transformed yeast with the wheat HMW glutenin genes (*HMWDx5* and *HMWDy10*) and synthesized in fermenters gram quantities of the HMW glutenins. The HMW glutenin proteins were extracted and highly purified. From the dough made with commercial wheat flour, all gliadins, LMW and HMW glutenins were removed by washing. The residues containing starch, soluble protein, fat, fibers and minerals were ground together with the purified HMW glutenin protein into flour, kneaded to dough and baked. The dough showed excellent elasticity and resultant bread rolls had the desired volume and internal structure.

Department of Crop and Soil Sciences, & School of Molecular Biosciences, Washington State University, Pullman WA 99164-6420 USA and Institute for Phytopathology and Applied Zoology, Justus-Liebig-University, Heinrich-Buff-Ring 26-32, D-35394 Giessen Germany

E-mail: diter@wsu.edu

The *lys 3a* regulatory mutant in barley points the way to celiac safe wheat

The recessive high lysine mutant 1508 (*lys 3a*) was selected after mutagenesis of the cultivar Bomi with ethyleneimine. Its lysine content in the grain protein was increased by 44% [5]. Feeding trials with rats and pigs revealed superior nutritional quality. Breeding by crossing the mutant gene into other genotypes produced the cultivars Piggy, Lysimax and Lysiba with high lysine and improved yield and thousand grain weights [6, 7]. The increased lysine content is primarily due to a reduction in prolamins and an increase in free amino acids. Ultrastructural information on the development of protein bodies in the barley endosperm of wild type and the high lysine mutants *lys 3a* and *hor 2ca* (Riso 56) was provided by electron microscopy [8]. The hordein polypeptides are synthesized on the polysomes of the endoplasmic reticulum, co-translationally transferred into the lumen of the endoplasmic reticulum and then into the storage vacuoles, where they are compacted into the protein bodies. Mutant *lys3a* produces very little B- and C- hordeins. Protein bodies of *lys3a* contain only D-hordein characterized by the resilin/elastic like fibrillar structure. The proposed pathway of protein body formation has been verified using isolated endoplasmic reticulum, isolated protein bodies and by localization studies with monoclonal antibodies for individual hordein polypeptides [9]. Cloning and sequencing of structural genes for B-, C- and γ -hordein polypeptides have corroborated that the *Hor 1*, *Hor 2*, and *Hor F* loci each consist of a family of closely linked structural genes for these proteins, with each gene having its own promoter [10]. Some of these genes contain stop codons, but transient transformation experiments revealed that expression of such a gene in the endosperm can take place by amber codon suppression [11]. The deposition of the prolamins in the protein bodies of wheat is similar to that in barley [12].

The nature of the high lysine mutant *lys 3a* was clarified [13 for review]. Transcripts encoding B-hordein, C-hordein and protein Z are practically absent in the developing endosperm of the mutant, while the transcript levels for D-hordein, glyceraldehyde-3-phosphate dehydrogenase and histone are normal. Mikael Blom Sørensen [14] showed by genomic sequencing and ligation mediated PCR that cytosines of 10 CpGs in the promoters of the B-hordein genes and 4 CpGs of the adjacent coding region of the gene are hypomethylated in the endosperm but fully methylated in the leaf. In the developing endosperm of the mutant demethylation of the B-hordein promoter does not take place. Genomic sequencing of the D-hordein gene promoter using bisulfite treated DNA revealed a CpG island and confirmed that the promoter is unmethylated in the leaf as well as in the endosperm both in the wild type and in the mutant [15].

This form of transcriptional control by DNA methylation and demethylation was rediscovered in 2002 in *Arabidopsis* in connection with studies of genetic imprinting. The 5-methylcytosine deglycosylase, named *DEMETER*, was cloned and the sequence identified for *Arabidopsis* [16, 17] and rice (Gene Bank Accession number AF521596). The *Arabidopsis* enzyme (1,729 aa) is a bifunctional helix-hairpin-helix DNA glycosylase with a proline-rich loop containing aspartic acid (D1304) and lysine (K1286) serving as catalytic residues in the 5-methylcytosine excision reaction [18]. An apyrimidinic lyase activity nicks the DNA generating a 3'-hydroxyl to which a DNA repair polymerase adds an unmethylated cytosine. A ligase completes the repair process by sealing the nick. In the barley endosperm this demethylation process and initiation of transcription takes place immediately prior to the accumulation of the hordein B, C and γ transcripts [19].

Thus, two categories of promoters for endosperm-specific gene expression can be distinguished; one that is silenced by methylation in vegetative tissues and has to be demethylated before activation of transcription can take place; the other solely dependent on removal of repressors or induction of transcription factors specific for the endosperm. In

hexaploid wheat, in each genome, on the long arm of chromosome 1, there are two linked genes encoding HMW glutenin. The promoter of the wheat HMW glutenin gene *Glu-1D-1b* [20, Acc.X12928] is 89% identical in nucleotide sequence to the barley D-hordein promoter and contains a similar number of CpG dinucleotides [15, 21]. It is therefore expected to be unmethylated in the developing endosperm and the other organs of the wheat plant. This provides the rationale for investigating, if in wheat –by analogy to barley– the gliadins and LMW glutenins can be eliminated by transcriptional silencing without affecting the synthesis of the HMW glutenins.

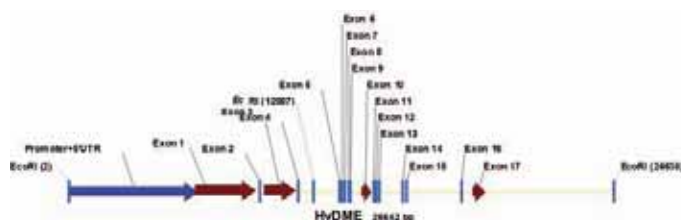

HvDME					
mRNA	bp	Exons	Protein	aa	Exons
	5943	17		1981	17

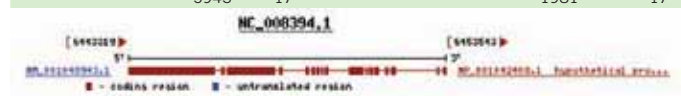

OsDME Os01g0217900 hypothetical protein [<i>Oryza sativa</i> Japonica Group]					
mRNA	bp	Exons	Protein	aa	Exons
NM_001048943.1	5784	17	NP_001042408.1	1927	17

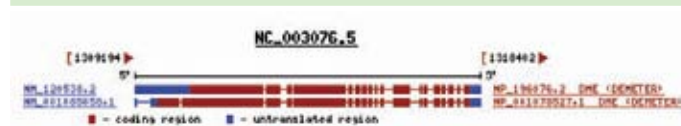

AtDME DME (DEMETER) [<i>Arabidopsis thaliana</i>]					
mRNA	bp	Exons	Protein	aa	Exons
Splice variant 1 NM_120538.2	6963	19	NP_196076.2	1729	18
Splice variant 2 NM_001085058.1	6475	20	NP_001078527.1	1987	19

Comparison of conserved Endo3/FES domain

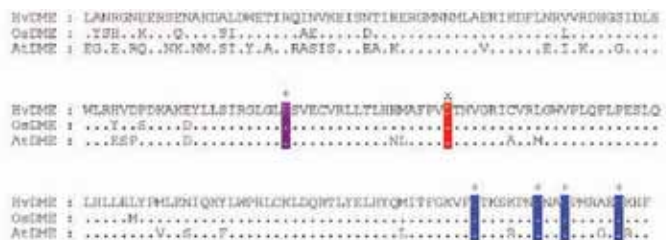

An asterisk marks the lysine residue that is diagnostic of a glycosylase/lyase activity, x indicates the conserved aspartic acid residue in the active site, and + the cysteine residues for binding [4Fe-4S] cluster. DME: DEMETER; Hv: *Hordeum vulgare*; Os: *Oryza sativa*; At: *Arabidopsis thaliana*.

Figure 1 The structure of the barley DEMETER gene (HvDME) compared to the rice gene (OsDME) and two gene splice variants of the *Arabidopsis* gene (AtDME). Below are the amino acid sequences of the conserved endonuclease / FES domain of the three enzymes.

Is the *lys 3a* mutation in the barley *Demeter* gene?

We have used the Plant Transcript Assembly Report TA38047_4513 from the TIGR Database covering 2312 nucleotides corresponding to *DEMETER* of *Arabidopsis thaliana* with 77.47% nucleotide identity and 56.52% coverage to design a forward and reverse primer using primer3 software. Primers TA38047for 5'-TGTGCGTCTTTTGACACTCC-3' and TA38047rev 5'-GCTCGTACAATGTCCGTTGA-3' were used to amplify barley genomic DNA or cDNA. PCR products were visualized by gel electrophoresis. The primers yielded in a PCR reaction on barley genomic and cDNA respectively a 342 and 187 nucleotide fragment. The sequence of the genomic fragment covers introns no. 6 and 7 and adjacent domains with a nucleotide coding identity between rice and barley of 91.6%. The fragment was radioactively labelled and hybridized to the filters of the cv. Morex six-row barley BAC library. The probe hybridized to a single BAC clone, which has been subcloned and sequenced as summarized in Fig. 1 (R. Brueggeman, G. Langen, J.Pang, unpubl.). With its guidance we are sequencing the *DEMETER* genes of the *lys3a* mutant and its mother variety Bomi. A suspected mutation will be verified by expressing wild type and mutant *DEMETER* cDNA clones in *E.coli* with a His-tag. The resulting proteins will be purified on a Ni²⁺-NTA column and their activity tested with methylcytosine containing double stranded oligonucleotides [18]. A mutation affecting the activity of the *DEMETER* protein will be recognized by its inability or reduced ability to excise 5-methylcytosine.

Analysis of promoter methylation/demethylation of genes encoding wheat prolamins

An analysis of the presence or absence of CpG islands revealed that the HMW-glutenin genes Glu-A1-2, Glu-B1i, Glu-1D-1b, Glu-1D-2b, Glu-1Ax1 and Glu-1Dy10 contained a CpG island in their promoter (S.Rustgi, unpublished). Thus the DNA of all six HMW-glutenin genes in the three genomes of bread wheat are expected to be unmethylated in the vegetative organs as well as in the developing endosperm and their transcriptional activity will be retained upon specific silencing of the wheat *DEMETER* genes in the developing endosperm. A CpG island was on the other hand not detected in the promoters of three α -gliadin genes (Gene Bank Acc. numbers X01130, X02538, X02540) and the LMW-glutenin gene GluD3-3 (DQ357058) and we expect therefore that the transcriptional activity of the gliadin and LMW glutenin genes can be eliminated in the endosperm by silencing the wheat *DEMETER* genes.

Three genes for wheat 5-methylcytosine DNA deglycosylases

Based on synteny studies with rice, two homologues of the *DEMETER* gene were located on wheat chromosomes 3DS (bin 3 FL 0.24-0.55) and 3AS (bin 4 FL 0.45-1.00), respectively. It will have to be determined if there is also a *DEMETER* gene in the B genome. Partial sequences of the *Demeter* domains in wheat, rice and barley databases have been aligned and display significant homology (S.Rustgi, unpublished). For wheat we have a 3' sequence of 981 nucleotides (pos. 6033-7014) from a 5-methylcytosine deglycosylase. With a radioactive labelled probe for this sequence we screened the hexaploid wheat (*Triticum aestivum*) BAC library containing 1.3 million clones, representing 7x coverage of the genome [22] and identified 12 BAC clones containing the targeted gene(s) (R. Brueggemann, C.G. Kannagara, unpublished). They are being fingerprinted by digestion with the *Hind*III restriction enzyme to identify the unique clones. It is expected that we can sequence and assemble the three expected genes for the 5-methylcytosine deglycosylases from these BAC clones.

Transient silencing of genes in the developing wheat spike using the barley stripe mosaic virus (BSMV)

It is likely that the three wheat *DEMETER* genes will contain identical DNA sequences in their coding regions and that these will be suitable

for transcriptional silencing of all three genes, thereby preventing the synthesis of the gliadins and LMW glutenins encoded in the three genomes in the developing endosperm. The *barley stripe mosaic virus* (BSMV) gene silencing procedure with constructs containing sense and antisense DNA fragments for phytoene desaturase [23] has been adapted to inhibit endosperm granule bound starch synthase (encoded by *waxy* gene) in the developing caryopses of the wheat spike (H. Pennypaul and K.S. Gill, unpublished), and thus provides a model for studying silencing of the *DEMETER* genes. BSMV is a positive-sense RNA virus with a tripartite genome consisting of RNAs α , β and γ . The three infectious RNAs are prepared from cDNA clones by *in vitro* transcription using T7 DNA-dependent RNA polymerase [24]. The modifications of BSMV for silencing or overexpression are as follows: The gene for the virus coat protein in the β -genome has been deleted. The γ -RNA cDNA clone was modified to allow insertion of sense or antisense fragments after the stop codon of its *yb* gene into a *PacI/NotI* cloning site. As a test, 200 bp fragments of granule bound starch synthase *GBSS1* and *GBSS2* (*Waxy*) were used to inhibit the synthesis of amylose in the developing endosperm. The infectious RNAs were rubbed on to the flag leaf prior to heading of the spike and arrived at eight days after fertilization during the development of the endosperm. They reduced the synthesis of amylose by 50%. It is intended to insert into the cloning site of the γ genome cDNA fragments of the wheat DNA 5-methylcytosine deglycosylase in sense or antisense direction and similarly infect the flag leaf. This will allow the recombinant viral RNA to arrive in the endosperm at 8 DAP, i.e., at the beginning of the gliadin synthesis and promoter demethylation. We will evaluate the inhibition of the synthesis of the wheat gliadin genes by PAGE analysis of endosperm proteins and transcripts by real time RT PCR and expect to find inhibition of gliadin and LMW glutenin synthesis but not for accumulation of HMW glutenins.

Wheat plants with mutations in the three 5-methylcytosine DNA deglycosylase genes

The three 5-methylcytosine deglycosylase genes of the three wheat genomes will have in their introns and/or exons sequence differences that distinguish them sufficiently to devise homoeolog-specific primers for TILLING (Targeting Induced Local Lesions in Genomes) of these genes in hexaploid Express spring wheat and Kronos tetraploid pasta wheat [25, 26]. In cooperation with Charles P. Moehs, Arcadia Biosciences Inc. the DNA of M₂ individuals of these two varieties will be screened with the specific primers identified for the three 5-methylcytosine deglycosylase genes. Briefly, the target gene sequences of the mutants will be amplified by PCR, heat denatured and re-annealed for heteroduplex formation between mutated and wild-type DNA. Heteroduplexes will be identified through cleavage with *CelI* endonuclease and can be visualized in a high throughput manner by size separation from the full-length PCR product on a polyacrylamide gel.

The mutants identified will be analyzed for their inhibition of gliadin and LMW glutenin synthesis. In case the deglycosylase genes of all three genomes of hexaploid and both genes of tetraploid wheat are actively transcribed and translated, separate mutants will have to be identified and combined by crossing. In order to speed propagation and characterization of the TILLED wheat mutants they are multiplied by doubled-haploid production via induced microspore embryogenesis permitting the production of ~1500 homozygous plants from a single spike in eight months [27]. Analyses of protein fractions of the mutants will be carried out with T-cell proliferation assays using the T-cell clones derived from celiac lesions [28]. The freeze-dried, proteolyzed endosperm protein samples will be dissolved in PBS with 2 mM CaCl₂ and treated with 100 μ g/ml human recombinant tissue transglutaminase for two hours at 37°C. The treated endosperm digests will be incubated overnight in triplicates in U-bottomed 96-well plates with 75,000 cells/well of DQ2 homozygous, irradiated (75-Gy) Epstein-Barr virus-transformed

B-lymphoblastoid cell lines in a volume of 100 µl of RPMI 1640 medium containing 10% pooled, heat inactivated human serum. These cell lines produce the DQ2 leucocyte antigen, to which the prolamin epitopes bind. After the incubation, 50 µl of freshly thawed T cells (1x10⁶ cells/ml) will be added to each well. The proliferation of the T cells is evaluated by [3H] thymidine incorporation from 48 to 72 hours after addition of the T cells.

Alternatively it is intended to inactivate the wheat 5-methylcytosine deglycosylase genes specifically in the wheat endosperm by silencing hairpin RNA with a modified pHELLSGATE vector ([29], Acc. No. AJ311874). Transformation will be carried out by co-cultivation of immature zygotic embryos with *Agrobacterium* [30, 31]. For specificity of silencing a HMW glutenin promoter and a nuclear localization signal can be employed.

ACKNOWLEDGEMENTS

Financial support by NIH grant 1R01 GM080749-01A2 and a Mercator Professorship from the German Research Foundation is gratefully acknowledged.

BIBLIOGRAPHY

- Shan, L. *et al.* Structural basis for gluten intolerance in Celiac Sprue. *Science* **297**, 2275 (2002).
- Fasano, A. *et al.* Prevalence of celiac disease in at-risk and not-at-risk groups in the United States. *Arch. Int. Med.* **163**, 286 (2003).
- Green, P.H.R., Cellier, C. Celiac Disease. *N. Engl. J. Med.* **357**, 1731 (2007).
- Bauer, I. Produktion funktioneller Weizen-Speicherproteine in transgenen Stämmen der Hefe *Saccharomyces*. PhD Thesis, Technical University Berlin (2005).
- Ingversen, J. *et al.* Induced seed protein mutant of barley. *Experientia* **29**, 1151 (1973).
- Munck, L. The case of high lysine barley breeding. In: *P.R. Shewry ed. Barley: Genetics, Biochemistry, Molecular Biology and Biotechnology. C.A.B. International, Wallingford, Oxon, UK*, 573-601 (1992).
- Gabert, V.M. *et al.* Protein quality and digestibility of new high-lysine barley varieties in growing rats. *Plant Food Nutr.* **48**, 169-179 (1995).
- Munck, L., Von Wettstein, D. Effects of genes that change the amino acid composition of barley endosperm. In: *Workshop on Genetic Improvement of Seed Proteins at Natl. Acad. Sci. US 1974*, 71 (1974).
- Rechinger, K.B. *et al.* A role of γ 3 hordein in the transport and targeting of prolamin polypeptides to the vacuole of developing barley endosperm. *Plant J.* **4**, 841 (1993).
- Sørensen, M.B. Mapping of the Hor2 locus in barley by pulsed field gel electrophoresis. *Carlsberg Res. Commun.* **54**, 109 (1989).
- Entwistle, J. *et al.* Amber codon suppression: the *in vivo* and *in vitro* analysis of two C-hordein genes from barley. *Plant Mol. Biol.* **17**, 1217 (1991).
- Gailili, G. *et al.* Wheat storage proteins: Assembly, transport and deposition in protein bodies. *Plant Physiol. Biochem.* **34**, 245 (1996).
- Von Wettstein, D. From analysis of mutants to genetic engineering. *Annu. Rev. Plant Biol.* **58**, 1 (2007).
- Sørensen, M.B. Methylation of B-hordein genes in barley endosperm is inversely correlated with gene activity and affected by the regulatory gen Lys3. *Proc. Natl. Acad. Sci. USA*, **89**, 4119 (1992).
- Sørensen, M.B. *et al.* Hordein promoter methylation and transcriptional activity in wild type and mutant barley endosperm. *Mol. Gen. Genet.* **250**, 750 (1996).
- Choi, Y. *et al.* An invariant aspartic acid in the DNA glycosylase domain of DEMETER is necessary for transcriptional activation of the imprinted MEDEA gene. *Proc. Natl. Acad. Sci. USA* **101**, 7481 (2004).
- Gehring, M. *et al.* DEMETER DNA glycosylase establishes MEDEA polycomb gene self-imprinting by allele-specific demethylation. *Cell* **124**, 495 (2006).
- Morales-Ruiz, T. *et al.* DEMETER and REPRESSOR OF SILENCING1 encode 5-methylcytosine DNA glycosylase. *Proc. Natl. Acad. Sci. USA* **103**, 6853 (2006).
- Radchuk, V.V. *et al.* The methylation cycle and its possible functions in barley endosperm development. *Plant Molec. Biol.* **59**, 289 (2005).
- Anderson, O.D. *et al.* Nucleotide sequences of the two high-molecular weight glutenin genes from the D-genome of a hexaploid bread wheat, *Triticum aestivum* L. cv. *Cheyenne*. *Nucleic Acids Res.* **17**, 461 (1989).
- Gu, Y.Q. *et al.*, Structural organization of the barley D-hordein locus in comparison with its orthologous regions of wheat genomes. *Genome* **46**, 1084 (2003).
- Allous, S. *et al.* Construction and characterization of a hexaploid wheat (*Triticum aestivum* L.) BAC library from the reference germplasm 'Chinese Spring'. *Cereal Res. Commun.* **31**, 331 (2003).
- Holzberg, S. *et al.* 2002. Barley stripe mosaic virus-induced gene silencing in a monocot plant. *Plant J.* **30**, 315 (2002).
- Petty, I.T. *et al.* Infectious barley stripe mosaic virus RNA transcribed *in vitro* from full-length genomic cDNA clones. *Virology* **171**, 342 (1989).
- Colbert, T. High-throughput screening for induced point mutations. *Plant Physiology* **126**, 480 (2001).
- Slade, A.J. *et al.* A reverse genetic approach to wheat crop improvement by TILLING. *Nature Biotechnol.* **23**, 75 (2005).
- Liu, W. *et al.* Highly efficient doubled- haploid production in wheat (*Triticum aestivum* L.) via induced microspore embryogenesis. *Crop Science* **42**, 686 (2002).
- Molberg, Ø.S. *et al.* Celiac disease: Methods and Protocols. In: *Methods in Molecular Medicine Vol.41*. M.N. Marsh Humana Press. Inc, Totowa NJ. (2007).
- Wesley, S.V. *et al.* Construct design for efficient, effective and high-throughput gene silencing in plants. *The Plant J.* **27**, 581 (2001).
- Cheng, M. *et al.* Genetic transformation of wheat mediated by *Agrobacterium tumefaciens*. *Plant Physiol.* **115**, 971 (1997).
- Horvath, H. *et al.* Experiences with genetic transformation of barley and characteristics of transgenic plants. In: *Barley Science*. The Harworth Press, New York, 143-176 (2002).

Maize Mutant *Opaque2* and the Improvement of Protein Quality Through Conventional and Molecular Approaches

Yunbi Xu^{1*}, R Babu¹, D J Skinner¹, B S Vivek² & J H Crouch¹

Abstract

Maize endosperm protein is deficient in two essential amino acids, lysine and tryptophan. Several spontaneous and induced mutations that affect amino acid composition in maize have been discovered, amongst which the *opaque2* gene has been used in association with endosperm and amino acid modifier genes for developing quality protein maize (QPM), which contains almost double the amount of lysine and tryptophan compared to normal maize. These increases have been shown to have dramatic impacts on human and animal nutrition, growth and performance. A range of hard endosperm QPM germplasm has been developed at the International Maize and Wheat Improvement Center (CIMMYT) mostly through conventional breeding approaches to meet the requirements of various maize growing regions across the world. Microsatellite and SNP markers located within the *opaque2* gene provide opportunities for accelerating the pace of QPM conversion programmes through marker-assisted selection (MAS). Thus, CIMMYT scientists are developing a package of reliable, easy-to-use markers for endosperm hardness and free amino acid content in the maize endosperm. Recent technological developments in molecular biology at CIMMYT such as single seed-based DNA extraction and low cost, high throughput SNP genotyping strategies promise enhanced efficiency and cost-effectiveness of QPM molecular breeding programmes. Here we present a summary of QPM research and breeding with respect to the history of conventional improvement methodologies, genetic and molecular basis of *opaque2*, epistasis between *opaque2* and other high lysine mutant genes and recent advances in genomics technologies that could potentially enhance the efficiency of QPM molecular breeding in future.

Introduction

Maize (*Zea mays* L.) plays a very important role in human and animal nutrition worldwide. In the mature maize kernel, two principal components, the endosperm and the germ (embryo), contain most of the kernel protein. Generally, the endosperm accounts for 80-85% and the embryo accounts for about 8-10% of the total kernel dry weight [1]. The endosperm may contribute as much as 80% of the total kernel protein. While the germ protein is superior in quality, the endosperm protein suffers from poor quality with respect to human and animal nutritional needs. The major drawbacks of maize endosperm protein are i) its deficiency in two essential amino acids – lysine and tryptophan, ii) high leucine – isoleucine ratio and iii) low biological value of utilizable nitrogen. The need to genetically ameliorate the poor nutritional value of maize has been recognized for a long time and several mutations, both spontaneous and induced, have been identified that affect the amino acid composition of maize endosperm. Among them, a spontaneous mutation of maize with soft, opaque grains, named *opaque2* (*o2*), has

been most intensively studied. Maize homozygous for the recessive *o2* allele has substantially higher lysine (>69%) and tryptophan content compared to normal maize [2].

Maize Protein

Maize endosperm protein is comprised of different fractions. Based on their solubility, these can be classified into albumins (water-soluble), globulins (soluble in saline solution), zein or prolamine (soluble in alcohol) and glutelins (soluble in alkali). In normal maize endosperm, the average proportions of various fractions of protein are albumins 3%, globulin 3%, zein (prolamine) 60% and glutelin 34%, while the embryo protein is dominated by albumins (+60%), which are superior in terms of nutritional quality. The zein in maize endosperm is low in lysine content (0.1g/100g of protein), which negatively affects growth of animals [3]. In *opaque2* maize, the zein fraction is markedly reduced, by roughly 50%, with a concomitant increase in the relative amounts of nutritionally superior fractions such as albumins, globulins and glutelins. The endosperm of *opaque2* maize contains twice as much lysine and tryptophan and 30% less leucine than normal maize. The decreased level of zein (5-27%) in *opaque2* maize along with reduced leucine, leads to more tryptophan for niacin synthesis, helps to combat pellagra and significantly improves its nutritional quality.

High lysine mutants in maize

Several mutants have been detected that favorably influence maize endosperm protein quality by elevating levels of two essential amino acids, lysine and tryptophan. The discovery of *opaque2* [2] was followed by recognition of the biochemical effects of *floury2* (*fl2*) [4]. Searches for new mutants continued and resulted in the discovery of several others such as *opaque7* (*o7*) [5], *opaque6* (*o6*) [6], *floury3* (*fl3*) [6], *mucronate* (*Mc*) [7] and *defective endosperm* (*De-B30*) [8]. Attempts were also made to find genotypes with high lysine genes that retained a high level of zein fraction. Two such mutants, *opaque7749* and *opaque7455* (*o11*) [9] are particularly interesting as they have markedly higher levels of lysine as well as a high prolamine fraction. The specific chromosomal location is known for some of the mutants. For example, the *o2* mutant is located on chromosome 7, *fl2* on chromosome 4, *o7* on chromosome 10, *fl3* on chromosome 8 and *de-B30* on chromosome 7. The genetic action of some of the mutants is also known, for example, *o2*, *o6*, *o7* and *o11* are completely recessive. The two *floury* mutants are semi-dominant and exhibit variable expression for kernel opacity and protein quality depending on the presence of one or more recessives in the triploid endosperm. The mutant *De-B30* is dominant and shows dosage effects on kernel opacity and zein content [10].

Pleiotropic and secondary effects of *opaque2* and other high lysine mutants

Genes and gene combinations that bring about drastic alterations in either plant or kernel characteristics also produce several secondary or undesirable effects. The low prolamine and high lysine mutants are no

¹ International Maize and Wheat Improvement Center (CIMMYT), Apartado, Postal 6-641, Mexico, 06600, DF, Mexico

² CIMMYT-Zimbabwe, 12.5 Km peg Mazowe Road, P.O. Box MP163, Mount Pleasant, Harare, Zimbabwe

* Corresponding author. E-mail address: y.xu@cgiar.org

exception. In addition to influencing several biochemical traits, they adversely affect a whole array of agronomic and kernel characteristics. The *o2* and other mutants adversely affect dry matter accumulation resulting in lower grain yield due to increased endosperm size. The kernels dry slowly following physiological maturity of the grain and have a higher incidence of ear rots. Other changes generally associated with high lysine mutants include thicker pericarp, larger germ size, reduced cob weight, increased color intensity in yellow maize grains, and reduction in kernel weight and density. Thus, despite the nutritional superiority of *opaque2* maize, it did not become popular with farmers or consumers mainly because of reduced grain yield, chalky and dull kernel appearance and susceptibility to ear rots and stored grain pests. Hence, CIMMYT undertook to improve the phenotype of *opaque2* kernels to facilitate greater acceptability by developing hard endosperm grain types with the protein quality of chalky *opaque2* strains. CIMMYT received financial support, beginning in 1965, from the United Nations Development Programme and introduced gene modifiers that changed the soft, starchy endosperm to a vitreous type preferred by farmers and consumers whilst retaining the elevated levels of lysine and tryptophan. CIMMYT has subsequently developed a range of hard endosperm *opaque2* genotypes with better protein quality through genetic selection, which are popularly known as quality protein maize (QPM). Today's QPM is essentially interchangeable with normal maize in both cultivation and agronomic characteristics as well as being competitive in terms of yield, lodging, disease and pest resistance, and moisture level, while retaining the superior lysine and tryptophan content. In 2005, QPM was planted on 695,200 hectares across 24 developing countries.

Conventional breeding approaches to develop QPM

There are various breeding options for developing hard endosperm – high-lysine maize that is competitive in agronomic performance and market acceptance, which are based on specific endosperm high lysine mutants or available donor materials. The past approaches involving normal maize breeding populations have centered on altering germ-endosperm ratio, selection for multiple aleurone layers, and recurrent selection to exploit natural variation for high lysine content. Altering the germ-endosperm ratio to favor selection of larger germ size will have the dual advantage of increasing both protein quantity and quality [11] but it is not practical to attain lysine levels approaching those of *opaque2* maize. Besides, increased germ size has the disadvantage of contributing to poor shelf life of maize. Recurrent selection for high lysine in normal endosperm breeding populations has been largely unsuccessful due to the narrow genetic variation and heavy dependence on laboratory facilities. Alternatively, high-lysine endosperm mutants provided two attractive options: i) exploiting double mutants involving *o2*, and ii) simultaneous use of the *o2* gene with endosperm and amino acid modifier genes. In most instances, double mutant combinations involving *o2* and other mutants associated with endosperm quality were not vitreous [12]. The most successful and rewarding option exploited the combined use of *o2* with associated endosperm and amino acid modifier genes.

Segregation and analysis of kernels with a range of endosperm modification began at CIMMYT as early as in 1969 by John Lonquist and V.L. Asnani. Initial efforts towards development of QPM donor stocks with good kernel phenotypes, as well as good protein quality, proved to be highly challenging. Two effective approaches, i.e., intra-population selection for genetic modifiers in *o2* backgrounds exhibiting a higher frequency of modified *o2* kernels and recombination of superior hard endosperm *o2* families, resulted in development of good quality QPM donor stocks with a high degree of endosperm modification. This was followed by the large-scale development of QPM germplasm with a wide range of genetic backgrounds, representing tropical, subtropical and highland maize germplasm and involving different maturities, grain color and texture. A summary of characteristics of promising QPM

genepools and populations developed at CIMMYT is provided in **Table 1**. An innovative breeding procedure designated as 'modified backcross cum recurrent selection' was designed to enable rapid and efficient conversion programmes [13]. More recently, pedigree backcrossing schemes have been used to convert elite QPM lines to maize streak virus (MSV) resistance for deployment in Africa as well as conversion of elite African lines to QPM.

Table 1. Characteristics of QPM genepools and populations developed at CIMMYT (using *o2* and associated modifiers) including protein, tryptophan and lysine contents in the whole grain [12].

QPM Pop/Pool	Adaptation	Maturity	Color	Texture	Protein (%)	Tryptophan in protein (%)	Lysine in protein (%)	Quality Index
Population 61	Tropical	Early	Y	Flint	9.2	0.98	4.2	3.8
Population 62	Tropical	Late	W	Semi-flint	9.9	0.92	3.9	4.4
Population 63	Tropical	Late	W	Dent	9.1	0.97	4.3	4.3
Population 64	Tropical	Late	W	Dent	9.6	1.00	3.8	4.3
Population 65	Tropical	Late	Y	Flint	9.2	0.96	4.2	4.4
Population 66	Tropical	Late	Y	Dent	9.3	1.01	4.3	4.3
Population 67	Subtropical	Medium	W	Flint	9.9	1.04	3.9	4.8
Population 68	Subtropical	Medium	W	Dent	9.5	1.01	4.0	4.3
Population 69	Subtropical	Medium	Y	Flint	10.0	0.98	4.2	4.4
Population 70	Subtropical	Medium	Y	Dent	9.3	1.10	4.3	4.7
Pool 15 QPM	Tropical	Early	W	Flint-Dent	9.1	0.94	4.2	4.6
Pool 17 QPM	Tropical	Early	Y	Flint	8.9	1.04	4.5	4.5
Pool 18 QPM	Tropical	Early	Y	Dent	9.9	0.93	4.0	4.6
Pool 23 QPM	Tropical	Late	W	Flint	9.1	1.03	3.8	4.2
Pool 24 QPM	Tropical	Late	W	Dent	9.4	0.92	3.8	4.0
Pool 25 QPM	Tropical	Late	Y	Flint	9.8	0.94	4.0	4.0
Pool 26 QPM	Tropical	Late	Y	Dent	9.5	0.90	4.1	4.3
Pool 27 QPM	Subtropical	Early	W	Flint-Dent	9.5	1.05	4.2	4.8
Pool 29 QPM	Subtropical	Early	Y	Flint-Dent	9.2	1.06	4.3	4.8
Pool 31 QPM	Subtropical	Medium	W	Flint	10.2	0.96	4.1	4.5
Pool 32 QPM	Subtropical	Medium	W	Dent	8.9	1.04	4.2	4.5
Pool 33 QPM	Subtropical	Medium	Y	Flint	9.3	1.05	-	4.2
Pool 34 QPM	Subtropical	Medium	Y	Dent	9.1	1.10	4.1	4.5

A QPM hybrid breeding programme was initiated at CIMMYT in 1985 as the QPM hybrid product has several advantages over open pollinated QPM cultivars: a) higher yield potential comparable to the best normal hybrids, b) assured seed purity, c) more uniform and stable endosperm modification, and d) less monitoring of protein quality required during seed production. Several QPM hybrid combinations were derived and tested through international trial series at multiple CIMMYT and NARS locations in Asia, Africa and Latin America. Current QPM breeding strategies at CIMMYT focus on pedigree breeding, whereby the best performing inbred lines and open pollinated varieties (OPV) with complementary traits are crossed to establish new segregating families. Both QPM×QPM and QPM × Normal crosses are made depending upon the specific requirements of the breeding project. In addition, backcross conversion is also followed to develop QPM versions of parental lines of popular hybrid cultivars that are widely grown in CIMMYT's target regions. Inbred lines developed through this process are then used in formation of QPM hybrids and QPM synthetic OPV [14].

Molecular basis of *o2* and modifier gene action

The breeding of QPM involves manipulation of three distinct genetic systems [14, 15]: i) the recessive mutant allele of the *o2* gene, ii) the

endosperm hardness modifier genes, and iii) the amino acid modifiers/genes influencing free amino acid content in the endosperm. The *o2* gene encodes a leucine-zipper class transcription factor that regulates the expression of zein genes and a gene encoding a ribosomal inactivating protein [16, 17, 18]. The homozygous recessive allele causes a decrease of the production of these zeins resulting in a corresponding increase in non-zein proteins, rich in lysine and tryptophan [19]. Additionally the recessive allele of the *o2* transcription factor also reduces the production of the enzyme, lysine keto-glutarate reductase, involved in free lysine degradation resulting in enhanced free lysine in the endosperm of *opaque2* maize. In the segregating generations, this recessive allele is selected either visually (identifying mosaic ears on F₂ harvests) or using molecular markers. The endosperm hardness modifier genes, which convert the soft/opaque endosperm to a hard/vitreous endosperm without much loss of protein quality, are selected through a low cost but effective method of light box screening, where light is projected through the vitreous grains or blocked by the opaque grains. Research at CIMMYT and elsewhere has demonstrated the quantitative and additive nature of the endosperm hardness modifying system [12]. Despite the presence of *o2* and associated endosperm hardness modifier genes, the lysine and tryptophan levels in segregating families vary widely indicating the existence of a third set of genes that modify the amino acid content, which necessitates systematic biochemical evaluation of lysine and/or tryptophan levels in each breeding generation.

Molecular breeding for QPM

The *opaque2* gene is recessive and the modifiers are polygenic. Their introgression into elite inbred lines is not straight forward because of three major factors: i) each conventional backcross generation needs to be selfed to identify the *opaque2* recessive gene and a minimum of four to six backcross generations are required to recover satisfactory levels of the recurrent parent genome, ii) in addition to maintaining the homozygous *opaque2* gene, multiple endosperm modifiers must also be selected, and iii) rigorous biochemical tests to ensure enhanced lysine and tryptophan levels in the selected materials in each breeding generation require enormous labor, time and financial resources. Although conventional breeding procedures have been used to convert commercial lines to QPM forms, these procedures are tedious and time consuming. Rapid advances in genomics research and technologies has led to the use of MAS which holds promise in enhancing selection efficiency and expediting the development of new cultivars with higher yield potential [20, 21]. While marker-assisted foreground selection [22, 23] helps in identifying the gene of interest without extensive phenotypic assays, marker-assisted background selection [24, 25, 26, 27] significantly expedites the rate of genetic gain/recovery of recurrent parent genome in a backcross breeding programme. With the development and access to reliable PCR-based allele-specific markers such as simple sequence repeats (SSRs) and single nucleotide polymorphisms (SNPs), MAS is becoming an attractive option, particularly for oligogenic traits such as QPM [28].

A rapid line conversion strategy for QPM has been developed [29], consisting of a two-generation backcross (BC) programme that employs foreground selection for the *opaque2* gene, in both BC generations, background selection at non-target loci in the BC₂ generation, and phenotypic selection for kernel modification and other desirable agronomic traits in two subsequent selfed generations. The rapid line conversion strategy outlined in this investigation brings together the salient features of both marker-assisted and phenotypic-based selection approaches such as fixing the large segregating generation for the target locus (*o2*), reducing the linkage drag by selection of flanking markers for recipient allele type, recovering maximum amount of recurrent parent genome within two BC generations and providing scope for precise phenotypic selection for desirable agronomic and biochemical traits on a reduced number of progeny.

Low-cost marker for *o2* and reliable markers for modifier genes of QPM

SSR markers (*umc1066*, *phi057* and *phi112*) located within the *opaque2* gene provide an excellent foundation for MAS, but this alone is not sufficient to bring to bear the full effectiveness of molecular breeding for QPM genotypes. Each of the microsatellite markers located within the *o2* gene is associated with factors that challenge their routine use in MAS programmes. *umc1066* is easily visualized on agarose gels but is commonly not polymorphic in CIMMYT breeding populations; *phi057* is difficult to visualize on agarose gels, usually requiring the use of polyacrylamide gels; *phi112* is a dominant marker, and hence cannot be used in the identification of heterozygotes in F₂/BC populations. However, *phi112*, which is based on a deletion in the promoter region, has the advantage of being a widely conserved marker, consistent with the phenotype in QPM germplasm tested. In order to overcome these difficulties, we have identified functional and more discriminative SNP markers that could be used in high throughput genotyping systems for selection of the *opaque2* genotype. These SNP markers have been used in the development of a medium throughput dotblot assay based on a detection system using hybridization on membranes, although these markers could also be readily detected using capillary electrophoresis systems.

Effective markers associated with modifying loci for both endosperm hardness and amino acid levels need to be identified. Unfortunately, little is known about the number, chromosomal location and mechanism of action of these modifier genes. A complex system of genetic control of these modifier loci with dosage effects, cytoplasmic effects, incomplete and unstable penetrance in different QPM germplasm creates a major bottleneck to the accelerated development of QPM germplasm. Using a limited set of restriction fragment length polymorphism (RFLP) markers and bulked segregant analysis [30], two chromosomal regions on the long arm of chromosome 7 that are associated with *o2* endosperm hardness modification were identified. The locus near the centromere is linked with the gene encoding the 27 kDa gamma zein. More recently, the analysis of two different QPM genotypes, K0326Y and cm105Mo2 (derived from CIMMYT's Pool 33 QPM), corroborated the existence of a common quantitative trait locus (QTL) near the centromere of chromosome 7 that appears to have a major effect (30% of the phenotypic variance) on *o2* endosperm modification, in addition to a QTL on 9.04/9.05 [31]. In a specific F₂ population segregating for kernel vitreousness, these two loci accounted for 40% of the phenotypic variation and thus may prove to be strong candidates for MAS for QPM breeding.

Precise information on genes controlling the level of amino acid modification, especially with respect to lysine and tryptophan, is relatively scarce and studies to date have found several quantitative trait loci (QTL) on many of the maize chromosomes [32, 33]. The free amino acid (FAA) content in Oh545o2 is 12 times greater than its wild-type counterpart, and three and 10 times greater than in Oh51Ao2 and W64Ao2, respectively. QTL mapping involving these materials identified four significant loci that account for about 46% of the phenotypic variance for FAA [34]. One locus on the long arm of chromosome 2 is coincident with genes encoding a *monofunctional aspartate kinase 2* (*Ask2*), whereas another locus on the short arm of chromosome 3 is linked with a *cytosolic triose phosphate isomerase 4*. Subsequent feedback inhibition analysis has suggested that *Ask2* is the candidate gene associated with the QTL on 2S [35] and that a single amino acid substitution in the C-terminal region of the *Ask2* allele of Oh545o2 is responsible for altered basal activity of the enzyme [36]. Using a RIL population from the cross between B73o2 (an *o2* conversion of B73) and a QPM line (CML161), it was possible to identify three QTL for lysine content and six QTL for tryptophan content, which explained 32.9% and 49.1% of the observed variation, respectively [37]. Thus a series of molecular markers (Table 2) for manipulation of different genetic components of QPM is available,

and hence their validation and fine mapping in appropriate breeding populations should now be carried out in order to establish a single cost effective MAS assay for molecular breeding of QPM. Concerted research efforts to quantify the effect of these loci affecting endosperm hardness and amino acid levels, coupled with marker development and validation will also accelerate the pace and precision of QPM development programmes.

Table 2. Molecular markers currently being validated at CIMMYT for manipulation of different genetic components of QPM.

Chromosome	Flanking markers	LRS*	PEV**	Reference
1) <i>opaque2</i> gene				
7S	umc1066, phi057, phi112 (located within the <i>o2</i> gene)			[29,38]
2) Endosperm harness modification (based on K0326YQPM × W64Ao2)				
1.05-1.06	umc1076-umc1335	12.8	5	[31]
7.02	umc1978-bnlg1022 (27kDa gamma zein gene)	75.3	28	[31]
9.04-9.05	umc1771-umc1231	29.4	12	[31]
10.02	phi063-umc1432	16.7	11	[31]
3) Free amino acid content (FAA)				
2L	bmc1633-bmc1329 (aspartate kinase2)	14.8	11	[34,36]
2S	bmc1537-bmc2248	12.8	10	[33]
3S	bmc1904-bmc2136/bmc1452	17.9	15	[33]
7L	bmc2328b-phi045	12.6	10	[33]

* LRS is the likelihood ratio statistic that measures the significance of the QTL.
 ** PEV (percent explained variance) is the percent of total variance explained by the QTL.

Seed DNA-based genotyping and MAS for QPM

Leaf collection from the field, labeling and tracking back to the source plants after genotyping are rate-limiting steps in leaf DNA-based genotyping. Recently, an optimized genotyping method using endosperm DNA sampled from single maize seeds was developed at CIMMYT [39], which has the potential to replace leaf DNA-based genotyping for marker-assisted QPM breeding. This method is suitable for various types of maize seeds, produces high quality and quantity of DNA and has minimal effects on subsequent germination and establishment. A substantial advantage of this approach is that it can be used to select desirable genotypes before planting, which can bring about dramatic enhancements in efficiency by planting only the plants containing the *o2* gene in recessive form in BC_nF₂ generations of Normal × QPM crosses, and also by minimizing the labor costs and scoring error associated with light-box screening of a large number of grains for endosperm hardness. Over several breeding cycles, this is likely to lead to cumulative and accelerated gains in selection pressure (such as light box screening for endosperm hardness modification and systematic biochemical evaluation of lysine and/or tryptophan) and improvements in overall QPM breeding efficiency.

Integrated approaches for improvement of enhanced protein quality in maize

Research at CIMMYT is currently focused on developing a package of molecular markers for cost-effective large scale, marker-assisted QPM breeding programme. We have developed gene-based SNP markers and a medium throughput, low cost dot blot genotyping assay using a membrane-based hybridization system for the *opaque2* gene. This system is likely to be especially useful for NARS programmes with limited lab facilities. In addition, intensive efforts are being made to develop and validate new as well as existing markers for the endosperm and amino acid modifier genes across a wide range of populations and

improved pools. A new breeding programme has recently been initiated at CIMMYT in collaboration with Guizhou Academy of Agricultural Sciences, China, to pyramid the *o2* with another high lysine mutant, *o16*, which was selected from Robertson's Mutator (Mu) stock where the lysine content in the F₃ *o2o2o16o16* families derived from recombination of both *o2* and *o16*, was about 30% higher than that of *o2o2* or *o16o16* F₃ families [40]. Using both genes together could lessen the requirement for phenotypic screening for amino acid content and genetic screening for amino acid modifiers.

Recent efforts in genetic transformation are focused on developing a dominant *opaque2* trait in maize. RNA interference (RNAi) technology has been used to reduce 22-kDa [41] and 19-kDa alpha zeins [42, 43] using antisense transformation constructs, which result in moderate increases (15-20%) in lysine content. In a recent study, using an improved double strand RNA (dsRNA) suppression construct, Huang, *et al.* [44] reported lysine and tryptophan levels similar to conventionally bred QPM genotypes. While the dominant nature of the anti-sense transgene is a definite advantage compared to recessive allele of *o2*, the opaque endosperm still needs to be modified by endosperm modifier genes whose epistasis with the transgene has not yet been tested. In addition, social acceptance and legislative concerns regarding genetically modified crops may prove to be a major bottleneck to their practical utility and large scale adoption in some developing countries. Efforts are underway at CIMMYT-Africa to create transgenic events using RNAi that could potentially enhance lysine and tryptophan to levels similar to QPM. Identification and improvement of lines with enhanced regenerability and transformability is in progress to facilitate RNAi efforts. Tropical maize lines, CML390, CML442, CML254 and CML492 were identified for their better regenerability and transformability, while CML395 was improved for transformation efficiency by crossing to temperate inbred line A188.

Cost effectiveness of marker assisted QPM breeding programmes Detailed cost-benefit analysis carried out at CIMMYT [45] with respect to MAS for QPM (*o2* gene alone) suggested that the relative cost effectiveness would depend upon specific circumstances. In cases where segregating materials can be visually inspected or light box screened to identify *o2* containing ears, conventional methods may prove to be more cost-effective although less accurate, while MAS may be a valuable tool with certain genetic backgrounds which do not allow easy phenotypic detection of *o2*. More recently, four BC₁F₂ populations segregating for *o2* were used to test the error rate of light-box screening and to estimate the cost of genotyping using a seed DNA-based genotyping method recently developed at CIMMYT, which makes it possible for MAS to be carried out before planting. For two populations where the light-box error rate was over 30%, it is predicted that there is an overall benefit from using MAS. Effective use of molecular markers for QPM would be achieved through seed DNA-based genotyping, and use of flanking markers around the *o2* gene to improve the efficiency of backcross selection. In addition, simultaneous MAS for the *o2* gene as well as modifier genes for amino acid content and endosperm hardness would provide a much more compelling cost-benefit ratio. This would reduce the need for phenotypic screening, saving time and screening costs. Moreover, when MAS is implemented for simultaneous selection of endosperm modifiers and other multiple traits such as disease resistance and other quality traits, the added value of MAS will be cumulative in terms of cost and time efficiency, as well as selective gain.

Conclusion

Biofortification of maize grains is an important area of research for which *opaque2* provides an ideal platform upon which a number of nutritionally important traits such as enhanced iron and zinc content and low phytate content (for increased bioavailability of nutrients) could be

combined for multiple benefits. Considering the pace of technological developments in genome research, a molecular breeding option is likely to be the leading choice in the future for stacking a range of nutritionally important specialty traits, especially those governed by recessive genes. With respect to *opaque2*, an additional challenge to field implementation of QPM is its recessive nature [14]. If QPM is pollinated by normal maize pollen, there may be loss of high protein quality resulting in erosion of the trait in farmer saved seed systems. Though several years of QPM testing at CIMMYT and elsewhere has proved this apprehension to be not significantly valid, training on good seed production practices to the local communities may ensure sustainable higher nutritional benefits of QPM in the long term.

BIBLIOGRAPHY

- Zuber, M.S., Darrah, L.L. Breeding, genetics and seed corn production. In: *Corn Chemistry and Technology*, Stanley, A.W. and Paul, E.R., Eds., American Association of Cereal Chemists, St. Paul, MN, 31 (1987).
- Mertz, E.T., Bates, L.S., Nelson, O.E. Mutant gene that changes protein composition and increase lysine content of maize endosperm. *Science* **145**, 279-280 (1964).
- Osborne, T.B., Mendel, L.B. Nutritive properties of protein of the maize kernel. *J. Biol. Chem.* **18**, 1-16 (1914).
- Nelson, O.E., Mertz, E.T., Bates, L.S. Second mutant gene affecting the amino acid pattern of maize endosperm proteins. *Science* **150**, 1469-1470 (1965).
- Misra, P.S., Jambunathan, R., Mertz, E.T., Glover, D.V., Barbosa, H.M. McWhirter, K.S. Endosperm protein synthesis in maize mutants with increased lysine content. *Science* **176**, 1425-1427 (1972).
- Ma, Y., Nelson, O.E. Amino acid composition and storage proteins in two new high lysine mutants in maize. *Cereal Chem.* **52**, 412 (1975).
- Salamini, F., DiFonzo, N., Fornasari, E., Gentinetta, E., Reggiani, R., Soave, C. Mucronate, mc, a dominant gene of maize which interacts with *opaque2* to suppress zein synthesis. *Theor. Appl. Genet.* **65**, 123-128 (1983).
- Salamini, F., DiFonzo, N., Gentinetta, E., Soave, C. A dominant mutation interfering with protein accumulation in maize seeds. In: *Seed Protein Improvement in Cereals and Grain Legumes*, IAEA, Vienna, 97 (1997).
- Nelson, O.E. The mutants *opaque9* through *opaque13*. *Maize Genet. Coop. Newsl.* **55**, 68 (1981).
- Soave, C., Reggiani, R., DiFonzo, N., Salamini, F. Clustering of genes for 20kd zein sub units in the short arm of maize chromosome 7. *Genetics* **97**, 363-377 (1982).
- Bjarnason, M., Pollmer, W.G. The maize germ: Its role as contributing factor to protein quantity and quality. *Zeitschrift Pflanzenzuchtung*, p.68- 83 (1972).
- Vasal, S.K. High Quality Protein Corn. In: *Specialty Corn* (Hallauer, A., Ed.), 2nd ed., CRC Press, p85-129 (2001).
- Vasal, S.K., Villegas, E., Bjarnason, M., Gelaw, B., Goertz, P. Genetic modifiers and breeding strategies in developing hard endosperm *opaque2* materials. In: *Improvement of Quality Traits of Maize Grain and Silage Use* (Pollmer, W.G. and Phipps, R.H. Eds) (1980).
- Krivanek, A.F., De Groote, H., Gunaratna, N.S., Diallo, A.O., Friesen, D. Breeding and disseminating quality protein maize (QPM) for Africa. *African J. Biotech.* **6**, 312-324 (2007).
- Bjarnason, M., Vasal, S.K. Breeding of quality protein maize (QPM). *Plant Breed. Rev.* **9**, 181-216 (1992).
- Bass, H.W., Webster, C., Obrian, G.R., Roberts, J.K.M., Boston, R.S. A maize ribosome-inactivating protein is controlled by the transcriptional activator *Opqae-2*. *Plant Cell* **4**, 225-234 (1992).
- Lohmer, S., Maddaloni, M., Motto, M., DiFonzo, N., Hartings, H., Salamini, F., Thompson, R.D. The maize regulatory locus *Opaque-2* encodes a DNA-binding protein which activates the transcription of the b-32 gene. *EMBO J.* **10**, 617-624 (1991).
- Schmidt, R.J., Burr, F.A., Aukerman, M.J., Burr, B. Maize regulatory gene *Opaque-2* encodes a protein with a leucine-zipper motif that binds to DNA. *Proc. Natl. Acad. Sci. USA* **87**, 46-50 (1990).
- Gibbon, B.C., Larkins, B.A. Molecular genetic approaches to developing quality protein maize. *Trends Genet.* **21**, 227-233 (2005).
- Ribaut, J.M., Hoisington, D.A. Marker assisted selection: new tools and strategies. *Trends Plant Sci.* **3**, 236-239 (1998).
- Xu, Y., Crouch, J.H. Marker assisted selection in plant breeding: From publications to practice. *Crop Sci.* **48**, 391-407 (2008).
- Tanksley, S. D. Molecular markers in plant breeding. *Plant Mol. Bio. Rep.* **1**, 1-3 (1983).
- Melchinger, A.E. Use of molecular markers in plant breeding. *Plant Breed.* **104**, 1-19 (1990).
- Young, N.D., Tanksley, S.D. RFLP analysis of the size of chromosomal segments retained around Tm-2 locus of tomato during backcross breeding. *Theor. Appl. Genet.* **77**, 353-359 (1989).
- Hospital, F., Chevalet, C., Mulsant, P. Using markers in gene introgression breeding programmes. *Genetics* **132**, 1199-1210 (1992).
- Frisch, M., Bohn, M., Melchinger, A.E. Comparison of selection strategies for marker assisted back crossing of a gene. *Crop Sci.* **39**, 1295-1301 (1999).
- Frisch, M., Bohn, M., Melchinger, A.E. Minimum sample size and optimum positioning of flanking markers in marker assisted back crossing for transfer of a target gene. *Crop Sci.* **39**, 967-975 (1999).
- Babu, R., Nair, S.K., Prasanna, B.M., Gupta, H.S. Integrating marker assisted selection in crop breeding-prospects and challenges. *Curr. Sci.* **87**, 607-619 (2004).
- Babu, R., Nair, S.K., Kumar, A., Venkatesh, S., Sekhar, J.C., Singh, N.N., Srinivasan, G., Gupta, H.S. Two-generation marker-aided backcrossing for rapid conversion of normal maize lines to quality protein maize (QPM). *Theor. Appl. Genet.* **111**, 888-897 (2005).
- Lopez, M.A., Gioverson, L., Larkins, B. Genetic mapping of *opaque2* modifier genes. *Maize Genet. Coop. Newsl.* **69**, 165 (2004).
- Holder, D.R., Hunter, B.G., Chung, T., Gibbon, B.C., Ford, C.F., Bharti, A.K., Messing, J., Hamaker, B.R., Larkins, B.A. Genetic analysis of *opaque2* modifier loci in quality protein maize. *Theor. Appl. Genet.* **117**, 157-170 (2008).
- Wu, R.L., Lou, X.Y., Ma, C.X., Wang, X.L., Larkins, B.A., Casella, G. An improved genetic model generates high-resolution mapping of QTL for protein quality in maize endosperm. *Proc. Natl. Acad. Sci. USA.* **99**, 11281-11286 (2002).
- Wang, X., Larkins, B.A. Genetic analysis of amino acid accumulation in *opaque2* maize endosperm. *Plant Physiol.* **125**, 1766-1777 (2001).
- Wang, X., Woo, Y., Kim, C., Larkins, B.A. Quantitative trait locus mapping of loci influencing elongation factor 1a content in maize endosperm. *Plant Physiol.* **125**, 1271-1282 (2001).
- Wang, X., Stumpf, D.K., Larkins, B.A. Aspartate kinase 2. A candidate gene of quantitative trait locus influencing free amino acid content in maize endosperm. *Plant Physiol.* **125**, 1778-1787 (2001).
- Wang, X., Lopez-Valenzuela, J.A., Gibbon, B.C., Gakiere, B., Galili, G., Larkins, B. Characterization of monofunctional aspartate kinase genes in maize and their relationship with free amino acid content in the endosperm. *J. Exp. Bot.* **58**, 2653-2660 (2007).
- Gutierrez-Rojas, L.A. Quantitative Trait Loci Analysis to Identify Modifier Genes of the Gene *opaque2* in Maize Endosperm. *Ph.D. Dissertation, Texas A & M University* (2007).
- Yang, W., Zheng, Y., Ni, S., Wu, J. Recessive allelic variation of 3 microsatellite sites within the *o2* gene in maize. *Plan Mol. Biol. Rep.* **22**, 361-374 (2004).
- Gao, S., Martinez, C., Skinner, D.J., Krivanek, A.F., Crouch, J.H., Xu, Y. Development of a seed DNA-based genotyping system for marker-assisted selection in maize. *Mol. Breed.* **22**, 477-494 (2008).
- Yang, W., Zheng, Y., Zheng, W., Feng, R. Molecular genetic mapping of a high-lysine mutant gene (*opaque-16*) and the double recessive effect with *opaque-2* in maize. *Mol. Breed.* **15**, 257-269 (2005).
- Segal, G., Song, R.T., Messing, J. A new opaque variant of maize by a single dominant RNA- interference-inducing transgene. *Genetics* **165**, 387-397 (2003).
- Huang, S.S., Adams, W.R., Zhou, Q., Malloy, K.P., Voyles, D.A., Anthony, J., Kriz, A.L., Luethy, M.H. Improving nutritional quality of maize proteins by expressing sense and anti-sense zein genes. *J. Agric. Food Chem.* **52**, 1958-1964 (2004).
- Huang, S.S., Kruger, D.E., Frizzi, A., D'Ordine, R.L., Florida, C.A., Adams, W.R., Brown, W.E., Luethy, M.H. High-lysine corn produced by the combination of enhanced lysine biosynthesis and reduced zein accumulation. *Plant Biotechnol. J.* **3**, 555-569 (2005).
- Huang, S., Frizzi, A., Florida, C.A., Kruger, D.E., Luethy, M.H. High lysine and high tryptophan transgenic maize resulting from the reduction of both 19- and 22-kD alpha-zeins. *Plant Mol. Biol.* **61**, 525- 535 (2006).
- Dreher, K., Khairallah, M., Ribaut, J.M., Morris, M. Money matters (I): costs of field and laboratory procedures associated with conventional and marker-assisted maize breeding at CIMMYT. *Mol. Breed.* **11**, 221-234 (2003).

Mutation Breeding for Oil Quality Improvement in Sunflower

J M Fernández-Martínez*, B Pérez-Vich & L Velasco

Abstract

Although sunflower oil is appreciated as a high quality commodity, new emerging markets and increasing concern about health risks are demanding changes in oil quality. The optimal quality of oils depends on their intended use either for food or non-food applications. The fatty acid composition and the total content and profile of tocopherols have been the most important traits considered in breeding for oil quality. Applications demanding a high nutritional value (salad oil) require a reduction of saturated fatty acids and enhancement of the vitamin E (alpha-tocopherol) content of the oil. Uses of oils in the food industry requiring plastic fats (margarines) demand an increased concentration of saturated fatty acids to avoid hydrogenation. High temperature processes (frying, biolubricants) need oils highly resistant to thermo-oxidation, with a high concentration of oleic acid and antioxidants (gamma- and delta-tocopherol). In sunflower, the utilization of mutagenesis has been the most successful procedure to generate genetic variability for these quality components. The mutagenic treatment is usually applied to seeds to obtain the M_1 generation and mutants are detected analyzing M_2 half seeds, allowing identification of mutants in one year. The most valuable sunflower oil quality mutants produced have been those with high oleic acid (>80%), high levels of either palmitic or stearic acid (>25%), low total saturated fatty acids (<7%) and increased levels of beta- (>65%), gamma- (>95%), and delta-tocopherol (>45%). The novel traits are, in all cases, governed by a small number of genes, which facilitate their management in plant breeding. This induced variation opens up the possibility of tailoring specialty sunflower oils for specific food and nonfood applications.

Introduction

Today, sunflower (*Helianthus annuus* L.) oil is the fourth most important vegetable oil in world trade, after soybean, palm, and canola, with an annual production around nine million tons and cultivated acreage over 22 million ha [1]. Sunflower oil has been traditionally appreciated as a high-quality commodity in the world oil market. However, new emerging markets together with an increasing concern about health risks of foods are demanding changes in oil quality. The optimal quality of sunflower oil depends on the intended use of the oil, either for food or non-food applications. The former include salad and cooking oils as well as oils for the food industry (margarines, shortenings, etc.). The latter comprises countless industrial sectors such as biodiesel and lubricants, surfactants, surface coatings, cosmetics, etc. Consequently, selection for a broad spectrum of oil types is required to fulfill the present and future needs of the industry. In general, oil characteristics that are undesirable for a particular application are required for others. Therefore, breeding for improved oil quality is a continuous exercise of divergent selection.

Components of oil quality: Breeding objectives for oil quality in sunflower

Vegetable oils mainly contain molecules of triacylglycerol (TAG). Triacylglycerols are glycerol molecules containing one fatty acid esterified to each of the three hydroxyl groups. The stereochemical positions of the three fatty acids in the glycerol molecule are designed *sn-1*, *sn-2*, and *sn-3* (Fig. 1).

FATTY ACID: $\text{CH}_3\text{-(CH}_2\text{)}_n\text{-COOH}$

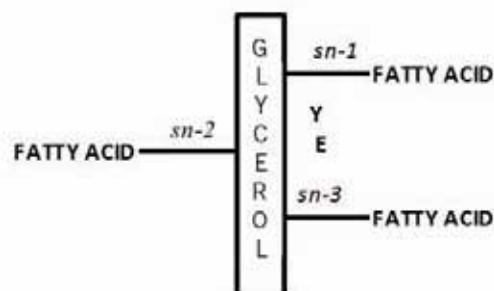

Figure 1 Schematic structure of a triacylglycerol molecule; *sn-1*, *sn-2* and *sn-3* refer to the carbon numbers of the glycerol; *sn-2* is a chiral center.

In sunflower, triacylglycerols represent more than 95% of the total oil weight. The remainder are lipid and lipid-soluble compounds, some of them of great value because of the functional and nutritional properties they confer to the oil. The fatty acid composition of the oil and the distribution pattern of the fatty acids within the triacylglycerol molecule determine the physical, chemical, physiological and nutritional properties of vegetable oils [2]. Therefore, breeding for oil quality in sunflower has mainly focused on the modification of the relative amount of fatty acids that are present in the oil, but in recent years minor compounds with important nutritional and antioxidant value, especially tocopherols and phytosterols, have also attracted the attention of sunflower breeders.

Fatty acids differ in their number of carbon atoms and/or number and position in the carbon chain of double bonds. Depending on the presence or absence of double bonds in the fatty acid chain, the fatty acids are divided into saturated, which do not contain double bonds, monounsaturated, with one double bond and polyunsaturated, which contain more than one double bond. For example, 18:1 designates an 18-carbon monounsaturated fatty acid (oleic acid). The unsaturated fatty acids can also have two possible configurations, *cis* or *trans*, depending on the relative position of the alkyl groups. Most naturally occurring unsaturated fatty acids have the *cis* orientation, although several common industrial processes such as hydrogenation, generate *trans* isomers which are considered to be nutritionally undesirable [3]. The tocopherols are a group of four lipid-soluble substances with molecular structure comprised of a chromanol ring and a saturated phytyl side chain (Fig. 2). The four tocopherols, named alpha-, beta-, gamma-, and delta-tocopherol, differ

Institute for Sustainable Agriculture (CSIC), Córdoba, Spain

* Corresponding author. E-mail: cs9femaj@uco.es

in the number of methyl substituents and the pattern of substitution in the chromanol ring [4].

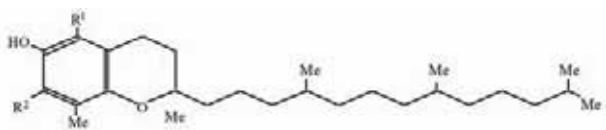

Figure 2 Chemical structure of tocopherols. Me=methyl groups. R¹=Me; R²=Me: α -tocopherol; R¹=Me; R²=H: β -tocopherol; R¹=H; R²=Me: γ -tocopherol; R¹=H; R²=H: δ -tocopherol.

Nutritional and functional properties of the oils are largely determined by the fatty acid composition of the oil, the distribution pattern of the fatty acids within the triacylglycerol molecule, and the total content and composition of natural antioxidants especially tocopherols. The main fatty acids in sunflower oil and their outstanding properties are given in **Table 1**.

Table 1. The major fatty acids in sunflower oil and their outstanding properties.

Trivial name	Symbol	Nutricional properties	Physical properties	Oxidative stability	Standard content (%)	Richest source (%)	Lowest source (%)
Palmitic	16:0	Hipercholesterolemico	Solid	High	6	33	4
Stearic	18:0	Neutral	Solid	High	5	37	2
Oleic	18:1	Hipocholesterolemico	Liquid	High	21	94	5
Linoleic	18:2 ^a	Hipocholesterolemico	Liquid	Low	68	85	2

^a Essential fatty acid that is not synthesized by the human body and has to be obtained from the diet.

Standard sunflower oil has an average fatty acid composition of 11% saturated fatty acids (palmitic-16:0- and stearic acid-18:0-), 20% oleic acid (18:1), and 69% linoleic acid (18:2), although the ratio linoleic/oleic acid, which together account for about 90% of the total fatty acids, is environmentally dependent, with a range of variation from 0.8 to 5.0 depending mainly on the temperature during seed development. From a nutritional point of view, the effect of fats on cholesterol levels depends on their fatty acid composition [5]. In general, saturated fatty acids are regarded as undesirable for human consumption, as they have a hypercholesterolemic effect, increasing both serum total cholesterol and low-density lipoproteins (LDL), and therefore the ratio LDL/HDL (high-density lipoproteins), compared with mono- and polyunsaturated fatty acids, which act to lower serum cholesterol. The exception is stearic acid which, in spite of being saturated, does not have any effect on cholesterol levels [6]. Oleic and linoleic acids are hypocholesterolemic but, although linoleic acid is an essential fatty acid, oleic acid is nowadays considered as the preferred fatty acid for edible purposes, as it combines a hypocholesterolemic effect [7] and a high oxidative stability [8]. Another parameter playing an important role in lipid nutritional value is the stereochemical position of the fatty acids in the three positions of the triacylglycerol molecule, as the absorption rate of the fatty acids is higher when they are esterified at the central *sn*-2 TAG position than when they are at the external *sn*-1 and *sn*-3 positions [9]. Thus, vegetable oils having undesirable saturated fatty acids at the *sn*-2 position, such as palm oil or partially hydrogenated fats, are more atherogenic than those having a similar total saturated fatty acid content but distributed at the external positions, as is the case of high palmitic acid sunflower [10].

Tocopherols exhibit differential *in vivo* and *in vitro* antioxidant activities. Alpha-tocopherol exerts a maximum *in vivo* activity, also known as vitamin E activity, but poor *in vitro* protection of the extracted oil, whereas gamma-, delta- and to a lesser extent beta-tocopherol are powerful *in vitro* antioxidants with low vitamin E value [4]. Applications

demanding a high nutritional value of the oil (e.g. salad oil) will require an enhancement of the vitamin E (=alpha-tocopherol) content of the oil. Other important oil quality components with important nutritional value, due to their ability to lower total and LDL serum cholesterol in humans, are phytosterols.

From a technological point of view, key aspects for most applications are plasticity and resistance to oxidation, particularly at high temperatures. Plastic fats are widely required in the food industry for the production of shortenings, margarines, and many specialty products. Because standard sunflower oil is mainly made up of unsaturated fatty acids, it is liquid at room temperature. Accordingly, its utilization by the food industry usually requires a previous chemical hardening to change it to a solid or semi-solid state, usually conducted by partial hydrogenation. However, partial hydrogenation also induces *cis-trans* isomerisation of fatty acids [3], resulting in the production of *trans*-fatty acids associated with heart disease [11]. These uses demand sunflower oils with high concentration of saturated fatty acids, preferably stearic acid which, as mentioned above, does not modify the plasma cholesterol content [6]. For high temperature applications and deep frying, oils with a lower content of polyunsaturated fatty acids are required. Thermo-oxidative experiments to test oil stability carried out at 180°C for 10-hour monitoring the formation of polar and polymer compounds of different oils showed that TAG polymerization varied with the type of oil [12]. For example, commodity polyunsaturated oils such as soybean, canola and standard sunflower oils must be rejected after eight hours at 180°C, while high-oleic sunflower oil could still be used after 10 hours and the high-palmitic and high-oleic oil last even longer. This indicates that oils with a higher content of oleic and palmitic acids are the best for high temperature applications. Tocopherols could also modify the thermo-oxidative stability of the oils. Experiments including high-oleic, high-palmitic sunflower oils containing either α -tocopherol or γ -tocopherol showed that the oil with γ -tocopherol had a much better performance at high temperature, as it produced less than half the polymerised triacylglycerols than the same oil with α -tocopherol [13].

Following the previous description of components of quality, it is clear that breeding objectives for oil quality in sunflower are multiple depending on the intended use of the oil. For example, applications demanding a high nutritional value of the oil (e.g. salad oil) will require a reduction of saturated fatty acids and enhancement of the vitamin E (=alpha-tocopherol) content of the oil. Conversely, the use of sunflower oil in the food industry requiring solid or semi-solid fats (e.g. margarines and shortenings) will demand an increased concentration of saturated fatty acids, mostly stearic, in order to avoid hydrogenation. For other food applications, including high temperature processes (e.g. frying oil industry), sunflower oils with high concentration of oleic acid and the *in vitro* antioxidants gamma- and/or delta-tocopherols are much more appropriate. For industrial non-food uses requiring high oxidative stability at high temperatures (biodiesel and biolubricants) high or very high levels of oleic acid and gamma- and/or delta tocopherols are required.

Sources of variability and screening procedures

Breeding for oil quality requires the availability of sources of variation for the different quality components and adequate screening techniques to measure them. Mutagenesis has been used successfully to generate genetic variability for sunflower seed oil quality traits. One of the most valuable mutants obtained was the variety "Pervenets," with oleic acid content above 75%. It was produced at the All-Union Research Institute of Oil Crops of the former USSR, after treatment with dimethyl sulfate (DMS) [14]. Inbred lines have been derived from Pervenets with oleic acid contents higher than 90% [15]. High and mid oleic acid mutants were also developed using ethyl methanesulphonate (EMS) treatments [16]. High levels of stearic acid (>25%) were achieved using the chemical mutagens EMS and sodium azide (NaN₃) [17, 18] and high levels of

palmitic acid were obtained using both physical mutagens (X-rays and γ -rays) [17, 19, 20, 21] and EMS [22]. Alternatively, low levels of saturated fatty acids were also obtained using chemical mutagenesis (EMS and N-methyl-N-nitrosourea, NMU) [23]. Mutants with increased levels of gamma-tocopherol (>95%) have been isolated following chemical mutagenesis with EMS [24]. A detailed list of the induced mutants with improved oil quality developed in sunflower and mutagens used are presented in **Table 2**.

The mutagenic treatment is usually applied to the seeds, which after treatment are named M_1 seeds. Mutants can be detected in the M_2 generation. In sunflower, both the fatty acid and the tocopherol profile of the

seeds are mainly under gametophytic control, i.e. they are governed by the genotype of the developing embryo. Therefore, mutants are detected by analyzing M_2 half-seeds.

Breeding programmes to improve seed oil quality traits require the development of accurate and fast screening techniques to measure them. Since fatty acid and the tocopherol profile of the sunflower seed oil are under gametophytic control, selection for these oil quality traits can be conducted at the single-seed level. Nondestructive methods to measure these traits in single seeds have been developed for different oil seed species. The half-seed technique developed for nondestructive analysis of the fatty acid composition of single seeds has been adapted to sun-

Table 2. Fatty acid and tocopherol composition of the principal induced mutants of sunflower in comparison with the standard types. The concentrations of the most altered fatty acids or tocopherols are printed in bold.

Induced mutants and derived lines with altered fatty acid composition								
Mutant or line	Oil type	Fatty acid composition (%) ^a					Mutagenic treatment	Reference
		16:0	16:1	18:0	18:1	18:2		
Standard ^b	Low/medium 18:1	5.7	---	5.8	20.7	64.5	---	
		6.5	---	3.0	40.9	49.6		
Low content in saturated fatty acids								
LS-1	Low 18:0	5.6	---	4.1	20.2	67.4	NMU (4-8 gkg ⁻¹)	[23]
LS-2	Low 18:0	8.6	---	2.0	10.8	75.0	NMU (4-8 gkg ⁻¹)	[23]
LP-1	Low 16:0	4.7	---	5.4	23.8	63.7	EMS (4-8 gkg ⁻¹)	[23]
High content in palmitic acid								
275HP	High 16:0	25.1	6.9	1.7	10.5	55.8	γ -rays (1550 R)	[19]
CAS-5	High 16:0	25.2	3.7	3.5	11.4	55.1	X-rays (150Gy)	[17]
CAS-12	High 16:0	30.7	7.6	2.1	56.0	3.1	X-rays (150Gy)	[20]
CAS-37	High 16:0-16:1	29.5	12.3	1.4	5.4	38.7	X-rays (150Gy)	[21]
NP-40	High 16:0	23.9	3.4	2.0	20.4	50.7	EMS (70 mM)	[22]
High content in stearic acid								
CAS-3	High 18:0	5.1	---	26.0	13.8	55.1	EMS (70 mM)	[17]
CAS-4	Medium 18:0	5.4	---	11.3	34.6	48.0	NaN ₃ (2-4 mM)	[17]
CAS-8	Medium 18:0	5.8	---	9.9	20.4	63.8	NaN ₃ (2-4 mM)	[17]
CAS-14	Very high 18:0	8.4	---	37.3	12.4	38.0	NaN ₃ (2-4 mM)	[18]
High content in oleic acid								
Pervenets	High 18:1	---	---	---	79.3	14.8	DMS (0.5%)	[14]
HO lines ^d	High 18:1	4.9	---	2.9	90.3	1.8	DMS (0.5%)	[15]
M-4229	High 18:1	3.4	---	4.1	86.1	3.9	EMS (0.1%)	[16]
M-3067	Mid 18:1	3.9	---	5.2	54.6	33.9	EMS (0.1%)	[16]
Induced mutants and derived lines with altered tocopherol composition								
Mutant or line	Oil type	Tocopherol composition (%)				Mutagenic treatment	Reference	
		α -T	β -T	γ -T	δ -T			
Standard	High α -T	95.0	3.0	2.0	0.0			
IAS-1	High γ -T	5.0	---	95.0	---	EMS (70 mM)	[24]	
IAS-540	High γ -T	5.0	---	95.0	---	EMS (70 mM)	[24]	
IAS-4	High δ -T	4.0	3.0	34.0	58.0	Recombination ^e	[24]	
IAS-5	High β -T	25.0	75.0	---	---	Recombination ^e	[24]	

^a 16:0=palmitic acid; 16:1= palmitoleic acid; 18:0=stearic acid; 18:1=oleic acid; 18:2=linoleic acid.
^b Data of standard cultivars obtained in cool and warm environments, respectively.
^c Contains also 4.6% of palmitolinoleic acid (16:2) and 5.8% of asclepic acid (18:1^{Δ11}).
^d Mean of four high oleic acid lines incorporating the Pervenets mutation.
^e Obtained through recombination between IAS-1 and the natural variant T589, with medium β -tocopherol content.

flower [25]. It consists of the removal of a small seed portion in the seed extreme distal to the embryo in such a way that the germination capacity of the seed is not affected. The excised half seed is used for chemical analysis, whereas the other half seed containing the embryo can be sown to produce a viable plant. The half-seed technique has been also used in sunflower for the nondestructive analysis of tocopherol composition and total tocopherol content [24].

Selection for seed quality at a single seed level has been facilitated by the use of near-infrared spectroscopy (NIRS) for analyzing the fatty acid profile of intact or hulled individual kernels. NIRS is a fast, non-destructive and cost-effective technique that permits the simultaneous analysis of multiple constituents in a single measurement. This requires the previous development of individual calibration equations for every constituent to transform NIRS spectral data into chemical information. However, the application of this technique to sunflower breeding requires the use of small samples of intact achenes. The feasibility of the use of NIRS in the analysis of oil quality components has been demonstrated for the determination oleic and linoleic acid concentration in the seed oil in intact achenes [26] or for large-scale screening for high stearic acid concentration in single hulled sunflower seeds [27].

Breeding and genetics

Comprehensive reviews on the genetics of quality traits in sunflower have been published [28, 29]. In general, the novel fatty acid and tocopherol traits obtained by mutagenesis are controlled by the genotype of the developing embryo and they are in all cases governed by a reduced number of genes, which considerably facilitates their management in plant breeding. For example, recessive alleles at three loci (*P1*, *P2*, *P3*) are involved in the control of high levels of palmitic acid content and partially-recessive alleles at loci *Es1*, *Es2* and *Es3* control high levels of stearic acid content. Detailed genetic studies showed that some of these recessive alleles were already present in the original lines and that the mutagenic treatments only induced a single recessive mutation in the wild dominant alleles, *P1* to *p1* in the high palmitic mutant CAS-5 and *Es1* to *es1* in the high stearic mutant CAS-3 [28]. The high oleic acid content is controlled by one principal gene *O11* and several modifier genes. Similarly, two unlinked genes, *Tph1* and *Tph2*, control altered tocopherol composition. Moreover, in recent years molecular markers have been developed for some of the traits, for example for high stearic and high oleic acid contents [30], or high beta- and gamma-tocopherol contents [31, 32]. The use of these molecular markers will contribute to improving breeding efficiency.

Concluding remarks

A tremendous range of variation for the main components of sunflower oil quality, the relative concentration of all the individual fatty acids and tocopherols present in sunflower seeds, has been obtained through mutagenesis. In contrast to other oilseed crops, this variation has been much higher than that obtained from naturally occurring variation. This progress has been made possible by the combination of chemical and physical mutagenesis and advances in analytical techniques which allow very rapid, cheap, reliable, and nondestructive analyses of fatty acid and tocopherols at a single-seed level. Mutants with high, intermediate and low levels of saturated fatty acids, mid and high levels of oleic acid, as well as high levels of beta-, gamma-, and delta-tocopherol have been developed providing more variability for fatty acid and tocopherol profiles in sunflower oil than in any other oilseed crop. For example, sunflower oil with low saturates and very high oleic acid, has the highest oleic acid levels (>92%) of any vegetable oil currently in the market. The novel fatty acids and tocopherol traits have a high environmental stability and they are in all cases governed by a small number of genes. Therefore, they can be easily managed in breeding programmes aimed at developing cultivars incorporating these traits. Moreover, progress

has been made over the last few years in the development of molecular markers for some of the modified oil quality traits, which will contribute to improve breeding efficiency, especially for those traits controlled by recessive genes or those more affected by the environment. The combination of several quality traits in a single phenotype will enable tailoring specialty oils providing essentially “new oilseed crops” for specific uses in the food and non-food industry, thus guaranteeing a promising future to sunflower in the global world market. In addition to the two sunflower oils currently available, the standard low oleic and the high-oleic acid oil (the first variant obtained by mutagenesis), new sunflower oils with modified tocopherols and fatty acid composition, developed through combination of the available mutants are foreseeable in the next few years. Some relevant examples are:

- Low saturated oils, both in standard and high oleic acid backgrounds and rich in vitamin E, suitable for salads and cooking.
- High stearic acid oils, in standard and high oleic acid backgrounds and rich in vitamin E, suitable for the production of more healthy margarines.
- Mid and high oleic acid oils combined with high content of *in vitro* antioxidants (gamma- and delta-tocopherol) usable for biodiesel and other applications requiring high temperature processes (deep frying, biodegradable lubricants).
- High palmitic acids oils in high oleic background and rich in gamma or delta tocopherols as an alternative for high temperature processes.

BIBLIOGRAPHY

1. Faostat, Oilseeds, Oils and Meals. *Statistical database of the Food and Agriculture Organization*. (2008) <http://www.fao.org>.
2. Padley, F.B., Gunstone, F.D., Harwood, J.L. Occurrence and characteristics of oils and fats. In: F.D. Gunstone, J.L. Harwood and F.B. Padley (Eds.), *The Lipid Handbook*. Chapman & Hall, London, 47-223 (1994).
3. Tatum, V., Chow, C.K. Effects of processing and storage on fatty acids in edible oils. In: C.K. Chow (Ed.), *Fatty Acids in Foods and Their Health Implications*. Marcel Dekker, New York, 337-351 (1992).
4. Packer, L., Obermüller-Jevic, U.C. Vitamin E: An introduction. In: L. Packer, M.G. Traber, K. Kraemer, and B. Frei (Eds.), *The Antioxidants Vitamins C and E*. AOCS Press, Champaign, IL, USA, 133-151 (2002).
5. Mensink, R.P., Zock, P.L., Kester, A.D.M., Katan, M.B. Effect of dietary fatty acids and carbohydrates on the ratio of serum total to HDL cholesterol and on serum lipids and apolipoproteins: a meta-analysis of 60 controlled trials. *Am. J. Clin. Nutr.* **77**, 1146-1155 (2003).
6. Mensink, R.P. Effect of stearic acid on plasma lipid and lipoproteins in humans. *Lipids* **40**, 12501-1205 (2005).
7. Mensink, R.P., Katan, M.B. Effect of a diet enriched with monounsaturated or polyunsaturated fatty acids on levels of low-density and high-density lipoprotein cholesterol in healthy women and men. *New Engl. J. Med.* **321**, 436-441 (1989).
8. Yodice, R. Nutritional and stability characteristics of high oleic sunflower seed oil. *Fat Sci. Technol.* **92**, 121-126 (1990).
9. Bracco, U. Effect of triglyceride structure on fat absorption. *Am. J. Clin. Nutr.* **60** (Suppl.) 1002s-1009s (1994).
10. Álvarez-Ortega, R., Cantisán, S., Martínez-Force, E., Garcés, R. Characterization of polar and nonpolar seed lipid classes from highly saturated fatty acid sunflower mutants. *Lipids* **32**, 833-837 (1997).
11. Willett, W.C., Ascherio, A. Trans fatty acids: are the effects only marginal?. *Am. J. Public Health* **84**, 722-724 (1994).
12. Marquez-Ruiz, G., Garcés, R., Leon-Camacho, M., Mancha, M. Thermostability of triacylglycerols from mutant sunflower seeds. *J. Am. Oil Chem. Soc.* **76**, 1169-1 174 (1999).
13. Marmesat, S., Velasco, L., Ruiz-Méndez, M.V., Fernández-Martínez, J.M., Dobarganes, C. Thermostability of genetically modified sunflower oils differing in fatty acid and tocopherol compositions. *Eur. J. Lipid Sci. Technol.* **110**, 776-782 (2008).

14. Soldatov, K.I., Chemical mutagenesis in sunflower breeding. In: *Proc. 7th International Sunflower Conference*, Krasnodar, USSR, 352-357 (1976).
15. Fernández-Martínez, J.M., Muñoz, J., Gómez-Arnau, J. Performance of near-isogenic high and low oleic acid hybrids of sunflower. *Crop Sci.* **33**, 1158-1163 (1993).
16. Vick, B.A., Miller, J. Utilization of mutagens for fatty acid alteration in sunflower. In: *Proc. 18th Sunflower Research Workshop*. Natl. Sunflower Assoc., Bismarck, ND, USA, 11-17 (1996).
17. Osorio, J., Fernández-Martínez, J.M. Mancha, M., Garcés, R. Mutant sunflower with high concentration in saturated fatty acid in the oil. *Crop Sci.* **35**, 739-742 (1995).
18. Fernández-Moya, V., Martínez-Force, E., Garcés, R. Temperature effect on a high stearic acid sunflower mutant. *Phytochem.* **59**, 33-38 (2002).
19. Ivanov, P., Petakov, D., Nikolova, V., Petchev, E. Sunflower breeding for high palmitic acid content in the oil. In: *Proc. 12th Int. Sunflower Conf.*, Novi Sad, Yugoslavia, 463-465 (1988).
20. Fernández-Martínez, J.M., Mancha, M., Osorio, J., Garcés, R. Sunflower mutant containing high levels of palmitic acid in high oleic background. *Euphytica* **97**, 113-116 (1997).
21. Salas, J.J., Martínez-Force, E., Garcés, R. Biochemical characterization of a high palmitoleic acid *Helianthus annuus* mutant. *Plant Physiol. Biochem.* **42**, 373-381 (2004).
22. Velasco, L., Pérez-Vich, B., Fernández-Martínez, J.M. A new sunflower mutant with increased levels of palmitic acid in the seed oil. *Helia* **31** (48), 55-60 (2008).
23. Miller, J.F., Vick, B.A. Inheritance of reduced stearic and palmitic acid content in sunflower seed oil. *Crop Sci.* **39**, 364-367 (1999).
24. Velasco, L., Pérez-Vich, B., Fernández-Martínez, J.M. Novel variation for tocopherol profile in sunflower created by mutagenesis and recombination. *Plant Breed.* **123**, 490-492 (2004).
25. Conte, L.S., Leoni, O. Palmieri, S. Capella, P., Lercker, G. Half-seed analysis: rapid chromatographic determination of the main fatty acids of sunflower seed. *Plant Breed.* **102**, 158-165 (1989).
26. Velasco, L., Pérez-Vich, B., Fernández-Martínez, J.M. Nondestructive screening for oleic and linoleic acid in single sunflower achenes by near-infrared reflectance spectroscopy (NIRS). *Crop Sci.* **39**, 219-222 (1999).
27. Velasco, L., Pérez-Vich, B., Fernández-Martínez, J.M. Use of near-infrared reflectance spectroscopy for selecting for high stearic acid concentration in single sunflower seeds. *Crop Sci.* **44**, 93-97 (2004).
28. Fernández-Martínez J.M., Velasco, L., Pérez-Vich, B. Progress in the genetic modification of sunflower oil quality. In: *Proc 16th Int. Sunflower Conference*, Fargo, ND, USA 1-14 (2004).
29. Fernández-Martínez, J.M., Pérez-Vich, B., Velasco, L. Sunflower. In: J. Vollmann and I. Rajcan (Eds) *Oil Crop Breeding. Springer Series Handbook of Plant Breeding* (in press) (2009).
30. Pérez-Vich, B., Fernández-Martínez, J.M., Grondona, M., Knapp, S.J., Berry, S.T. Stearoyl-ACP and oleoyl-PC desaturase genes cosegregate with quantitative trait loci underlying stearic and oleic acid mutant phenotypes in sunflower. *Theor. Appl. Genet.* **104**, 338-349 (2002).
31. Vera-Ruiz, E.M., Velasco, L., Leon, A.J., Fernández-Martínez, J.M., Pérez-Vich, B. Genetic mapping of the *Thp1* gene controlling beta-tocopherol accumulation in sunflower seeds. *Mol. Breed.* **17**, 291-296 (2006).
32. García-Moreno, M., Vera-Ruiz, E.M., Fernández-Martínez, J.M., Velasco, L., Pérez-Vich, B. Genetic and molecular analysis of high gamma-tocopherol content in sunflower. *Crop Sci.* **46**, 2015-2021 (2006).

The Multiple Uses of Barley Endosperm Mutants in Plant Breeding for Quality and for Revealing Functionality in Nutrition and Food Technology

L Munck* & B Møller Jespersen

Abstract

This paper describes, with examples, how biochemical seed mutations can be used not only to improve quality in cereals, but also to understand functionality in nutrition and in food processing, and even to provide an overview of gene expression for improved genetic theory. A high lysine barley mutant Risø 1508 (*lys3.a*) cross breeding material developed at Carlsberg between 1973 and 1988 is used to demonstrate how Near Infrared Reflectance (NIR) spectra evaluated by a Principal Component analysis (PCA) score plot can visualize an improved chemical composition resulting from an altered genotype. By introducing high lysine *lys3.a* recombinants with increased starch and yield to pig feeding, protein concentration in the feed, nitrogen load on the animal and, also, importantly nitrogen load on environment could be reduced by 15-20% without compromising meat production. The decreased nitrogen load on the animal spares the energy that is necessary to catabolize the surplus of non-essential amino acids. The lower carbohydrate content and lower energy digestibility in the improved *lys3.a* lines is likely to be compensated by a more efficient metabolism of the protein. Thus, the high lysine mutants are contributing to the understanding of animal physiology. Similarly, the technological importance of slender cell walls and low β -glucan was elucidated using mutant M-737 from Carlsberg, which accelerated malt modification to spare one to two days. The vast majority of scientists are traditionally rather pessimistic about the possibility of repairing the negative pleiotropic effects of mutations by engaging in the hard and time-consuming work of cross breeding. An open holistic exploratory strategy is necessary in order to evaluate the great complexity of the pleiotropic effects of a mutant gene that can not be forecasted by prior scientific knowledge. This is now possible by exploiting NIR Spectroscopy as a coarse overview of the phenotype (Phenome) on the level of chemical bonds.

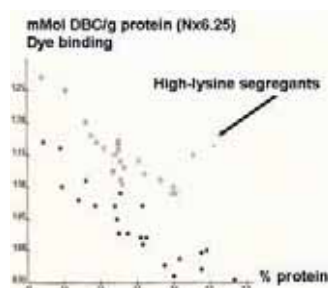

Figure 1 Selection of high lysine (squares) and normal (black dots) recombinants from a cross between Hiproly x normal barley from the dyebinding/Kjeldahl protein plot (Munck, 1972).

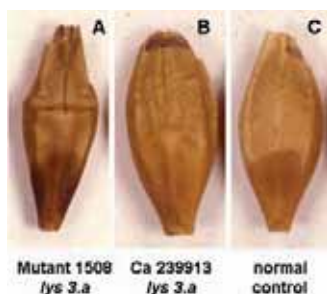

Figure 2 Visualising the result of 15 years of breeding at Carlsberg for improved seed quality, starch content and yield in Risø 1508 (*lys3.a* mutant). (A) Original M-1508 mutant. (B) Improved high-lysine recombinant Ca239913. (C) Normal control (Munck, 1988).

Introduction

This paper focuses on what can be learnt, both practically and theoretically, from the intense research on cereal-seed mutants conducted in the 1960's through the 1980's sponsored by the IAEA/FAO. In the 1960's there was major concern regarding the low nutritional quality of cereal protein as a food to children, where lysine was the limiting amino acid. In 1964 a dye-binding capacity (DBC) screening method (Fig. 1) was developed to assay basic amino acids (lysine), which was used in 1966 to identify the first high lysine gene in an Ethiopian cultivar, later called "Hiproly," from the world barley collection (CI3947) [1]. Hans Doll and his group at the Risø National Nuclear Laboratory in Denmark used the DBC method extensively in the 1970's to isolate about 25 barley mutants with moderate-to-high lysine content in their protein. These were all more or less depleted in starch and had lower yields and seed quality than their mother variety [2]. The most radical mutant was Risø 1508 in Bomi (gene *lys3.a*), which had a 45% increase in lysine and a biological value near to milk proteins. A pig trial conducted by H.P. Mortensen and A. Madsen at the Royal Veterinary and Agricultural University (KVL) using Risø 1508 recorded an 84% increase in growth over three months (Fig. 3), reducing the barley consumed to obtain a 90 kg slaughter weight from 538 kg for normal barley to 209 kg for the Risø 1508 mutant. The experiment was made without protein additives.

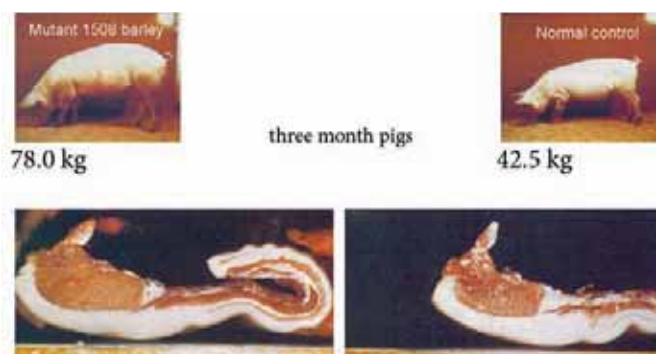

Figure 3 Functionality of improved protein by essential amino acids (lysine) demonstrated in a pig feeding trial with the Risø M-1508 (*lys 3.a*) mutant and a normal control without protein supplement. Mortensen and Madsen, 1988. See Table 3.

In 1973, the senior author started a programme at the Carlsberg Research Laboratory to induce mutants in barley with reduced extract viscosity (β -glucan) and to breed for a genetic background for the *lys3a* gene that could improve seed quality (Fig. 2), starch content and yield. This was successful (Fig. 3, Table 1, [3]). However, while protein (soy bean meal) was imported to the EU at world market prices, starch obtained a higher market price through earlier EU subventions on cereals. Starch was three to six absolute percent lower in high-lysine barley. This was one of the reasons why the high protein-lysine mutant is today almost forgotten. However, the current rapidly rising food prices may introduce new world market priorities that support improved cereal protein in barley, maize and sorghum.

Spectroscopy and Chemometrics Group, Quality and Technology, Department of Food Science, Life Science Faculty, University of Copenhagen, Frederiksberg, Denmark

* Corresponding author. E-mail: lmu@kvl.dk

Table 1. Agronomic characters of high-lysine *lys3.a* breeding lines, mutant 1508 (*lys3a*) and Bomi in relation to national barley reference (from Bang-Olsen, *et al.*, 1991[3]).

	Yield				1000 KW g	Chemical composition d.m. 1989			
	1988*	1989*	1990 I	1990 II		1988	Protein %	Lysine g/16gN	Starch %
Reference Yield ^a	(58)	(79)	(59)	(67)	(51)				
Relative Yield (HKg ha ⁻¹)	100	100	100	100					
Variety									
Bomi	101	102	91	98	52	11.4	3.6	59	2.3
R-1508	89	83	81	84	46	12.9	5.2	54	3.0
Ca429202 (Carla cross)	101	93	96	103	42	10.8	5.6	56	2.9
Ca533601 (Alis cross)	-	102	105	110	43	11.1	5.6	55	3.0

Developing efficient screening tools for simple and complex quality variables

In the IAEA/FAO research programme from 1968 to 1982, there was a considerable effort to develop and test new screening tools for specific chemical variables of nutritional importance [4]. This also included the physical option of Near Infrared Reflection Spectroscopy (NIR) combined with multivariate data analysis (chemometrics) that was introduced for quality control in the cereal industry, including Carlsberg Breweries, in the mid-1970's and was further developed by our group in Spectroscopy and Chemometrics at the Life Science Faculty of the University of Copenhagen from 1991 [5, 6]. In the remainder of this article, we will use data on the mutant *lys3.a* cross breeding material developed at Carlsberg in 1973-1988 to demonstrate how NIR spectroscopy evaluated by Principal Component Analysis (PCA) can visualize changes

in seed composition, such as starch content, resulting from genetic improvement. We will also demonstrate how the calcofluor screening method for malt modification and a flotation method for kernel density can be used to test gene expression in a slender endosperm cell wall/low β -glucan mutant developed at Carlsberg by Sten Aastrup [7].

“Data Breeding” for complex quality traits: Using NIR spectroscopy data and a PCA score plot to select improved segregants

In Table 2 [6] the chemical composition of 15 genotypes from the Carlsberg *lys3.a* material is presented. The original mutants (Group 4) have lower starch content (48.7%) than normal barley (54.6%). The improved *lys3a* breeding lines (Group 1) and unselected *lys3.a* recombinants (Groups 2 and 3) are intermediate in starch content. A low amide to protein A/P index (Table 2) is indicative for high lysine. Comparing NIR spectra in the short wavelength area interval 2260-2380 nm it is seen that the spectral patterns for the normal control Triumph and the original *lys3.a* mutant are quite different, with a plateau for Triumph at 2290 nm (marked 1) compared to a slope for *lys3.a*. The latter has a characteristic peak at 2347 nm (marked 2), assigned to fat, that is increased by 55%. The improved semi-commercial *lys3.a* lines, Lysimax and Lysiba, are approaching the normal (Triumph) spectral pattern with regard to the plateau and peak marked 1 and 2.

The differences in patterns of whole log 1/R multiple scattered corrected NIR spectra (400-2500 nm) of the 15 genotypes are represented as distances in a PCA scoreplot (Fig. 4B). It is seen that the improved *lys3a* genotypes with increased starch Lysiba (52.2%) and Lysimax (52.9%) are moved from the position above to the right of the original *lys3.a* mutant (starch 48.5%) towards the position of the normal barley Triumph (starch 58.5%) down to the left. The PCA biplot of chemical data (Table 2) in Fig. 4C confirms the pattern of the corresponding spectral PCA

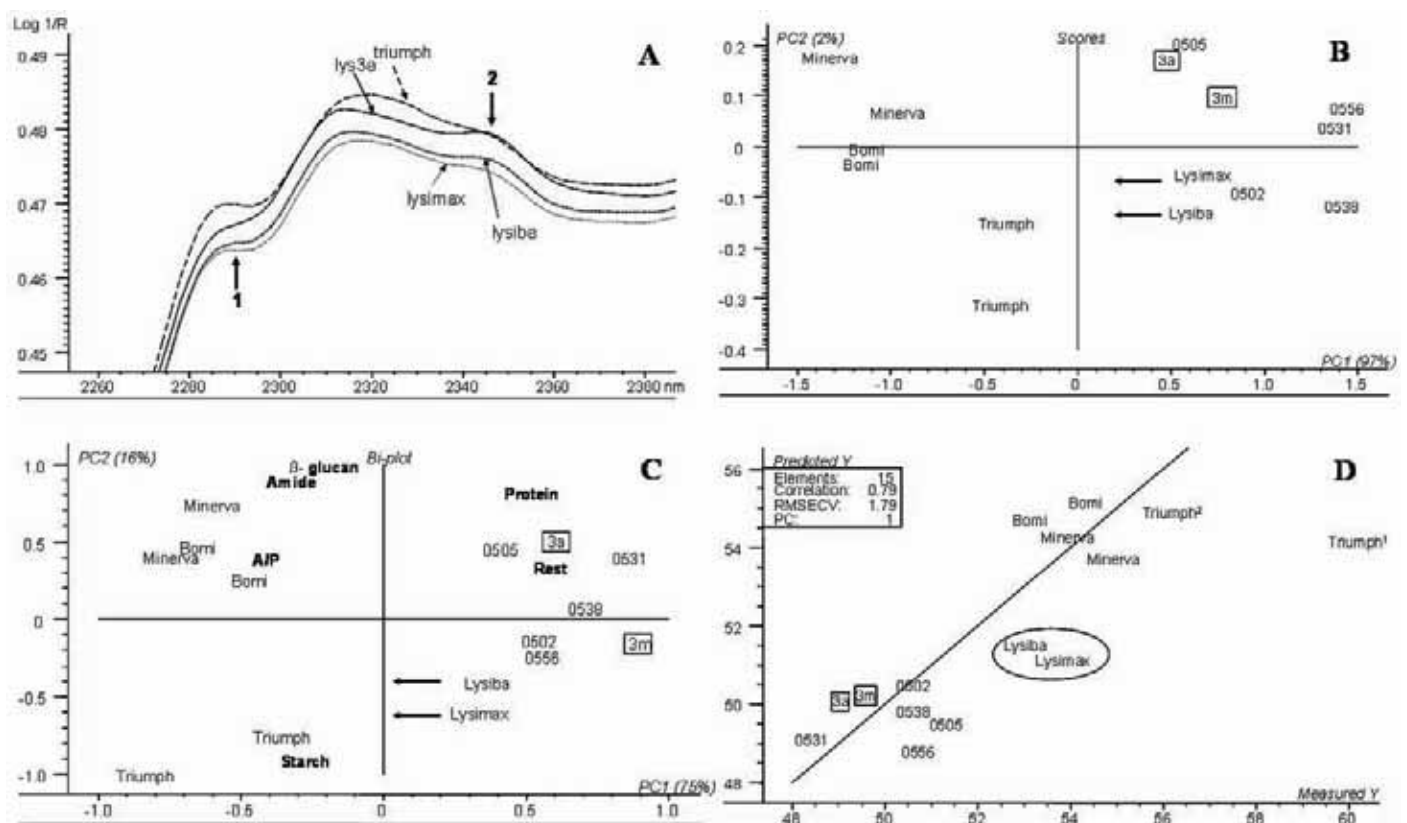

Figure 4 (A) Comparison of the MSC NIR area 2260-2380 nm for samples of Triumph, mutant *lys3a* and high lysine recombinant lines Lysiba and Lysimax. Numbers are referred to in the text. (B) PCA score plot of NIR (MSC) spectra from normal barley (Bomi, Minerva, Triumph), mutants (*lys3.a*, *lys3.m*) as well as high lysine recombinant lines (0502, 0505, 0531, 0538, 0556, Lysiba, Lysimax). (C) PCA biplot of chemical data (protein, β -glucan, amide, A/P, starch) at the same material. (D) PLSR prediction plot of starch (y) by NIR measurements (x).

scoreplot (Fig. 4B). NIR spectra indicate patterns of chemical bonds that may be identified from the literature. In the chemical PCA biplot in Fig. 4C the variable “starch” is positioned near Triumph, indicating a high level of starch in this cultivar. The move in both PCA's (Fig. 4B, 4C) of the Lysiba and Lysimax genotypes from the position of the original low starch *lys3.a* mutant towards the high-starch variety Triumph indicates a clear improvement in starch content.

The NIR and chemical data sets are combined in the Partial Least Squares Regression (PLSR) starch prediction plot in Fig. 4D. This is, in principle, how NIR and NIT spectroscopy are utilized today by plant breeders for chemical prediction, using large calibration sets from the instrument manufacturers to obtain precision when dealing with many varieties and environments. It is possible empirically, and without elaborate calibration by comparison to a high-quality genotype control, to select for the whole expression of physical and chemical attributes at the spectral level in a cross-breeding programme by “data breeding” [5, 6].

A complex quality trait such as starch and nutritional value (described here) or malt and baking quality [5, 6] can be represented as a whole spectral pattern by NIR and NIT spectroscopy. This can be done without chemical analysis, except for the confirmation and evaluation of the final varieties. It is clear that NIR and NIT spectroscopy combined with PCA and PLSR data analysis (chemometrics) is a revolution in cost-effective breeding for quality in all cereals [5].

Table 2. Average and standard deviation of chemical data for five chemical groups [6]

	Normal (n=6)	Group 1	Group 2	Group 3	Group 4
Protein (P)	11.3±0.4	11.7±0.1	11.7±0.1	12.6±0.2	12.5±0.2
Amide (A)	0.28±0.03	0.21±0.007	0.21±0.007	0.22±0.02	0.23
A/P	15.5±0.9	11.0±0.3	10.9±0.4	10.7±0.8	11.4
Starch (S)	54.6±2.5	52.6±0.5	50.0±0.1	49.4±1.5	48.7±0.2
β-glucan (BG)	4.7±1.1	3.1±0.1	3.1±0.1	3.1±0.3	2.8±0.5
Rest (100-P+S-BG)	29.5±1.8	32.7±0.5	35.3±0.3	34.9±1.8	36.1±0.5

Group 1=Lysiba, Lysimax; Group 2=502, 556; Group 3=505,531,538; Group 4=lys3a, lys3m

The impact of barley seed mutants on defining functionality in nutrition.

It is often forgotten that the introduction of, for example, a high lysine mutant for practical use in the agricultural and feed industries can be looked upon as a question to nature that could lead to surprising revelations. One such surprise was when we found by NIR spectroscopy [8 and IAEA-CN-167-300 these proceedings] that the three minor lysine mutants Risø 13, 16 and 29 (and three others) contained a β-glucan content of up to 20% dry matter (d.m.). They had previously been identified as structural mutants for ADP-glucose phosphorylation and transport in starch synthesis. Obviously they inherited a surprisingly pleiotropic effect with regard to β-glucan production that compensated largely for the decrease in starch. Because β-glucan, as a dietary fiber, does not contribute to metabolic energy, there is no interest in feeding monogastric animals high-β-glucan/low-starch mutants. However, the high fiber and low caloric content (down to a 50% reduction) in these mutants made them attractive as a source of human food with the potential to reduce cholesterol [8].

Table 3. Feed trial with Piggy high lysine barley [10].

	Protein%	Lysine g/16gN	Fat%	Carb.*	N digest%	Nitrogen retention	Metabolizable energy MJ/kg DM
Lami	13.2	3.64	3.3	62.7	72	22	14.1
Piggy	14.0	5.50	5.5	57.7	69	35	14.0

* Carb. = starch + sugars

The original Risø 1508 *lys3.a* mutant has a reduced β-glucan content of about 2-4% (compared to 4-6% in normal barley). Nevertheless, Risø 1508 has a 5% absolute decrease in starch and a 2% decrease in digestible energy that should reduce metabolisable energy. The decrease in starch is energy-wise partly counterbalanced by an increase in fat from approx. 2 to 3.5%. Early on in our breeding work with *lys3.a*, we gave a rather pessimistic account on the economic value of the Risø 1508 mutant at the 4th IGBS meeting in Edinburgh in 1981 (Bach Knudsen and Munck [9]). This was because the low energy digestibility of -2 to -4% (in spite of increased fat) that was published in the literature for the Risø 1508 mutant for rats and pigs. Our view was also influenced by the overrating of cereals by EU subventions at the time, favoring available carbohydrates (starch) at the expense of a nutritionally balanced protein. Increasing starch content through the *lys3a* breeding programme at Carlsberg (see Bang Olsen, Stilling and Munck 1991, Table 1 [3]) and the pig feeding trials that are reported in the following section changed our view.

The mutant lines were instrumental in understanding the functionality of amino acid energy relationships in feeding trials with pigs using the original Risø 1508 mutant (Fig. 2) and with the starch improved *lys3.a* variety Piggy (Table 3). Pig trials were undertaken between 1984 and 1989 by H.P. Mortensen and A. Madsen at KVL and by B.O. Eggum at Foulum. The results were summarized in English in 1992 [10]. A pig trial with the Piggy *lys3.a* recombinant and a normal feed barley Lami was made without protein supplementation (Table 3). The barley field trial was performed with late nitrogen fertilizer addition to increase protein content from about 11% to 14.0% and 13.2% for Piggy and Lami, respectively. This reduced yield and increased the difference in carbohydrates (starch + sugars) between the two barleys to 5% in absolute terms. Protein (N) digestibility was reduced by 3% and energy digestibility by 2% confirming rat trials [10]. It was surprising, however, that the metabolizable energy of Piggy was only 0.1% less than the Lami control (Table 3). The explanation was obtained in a parallel soy bean meal supplementation trial by Mortensen and Madsen [10] employing the same barley samples as in Table 3, which was more suitable from a pig production point of view.

Soybean meal could, in restrictive feeding, be reduced from 40.9 kilos per pig down to 25.9 kilos and, in *ad libitum* feeding, from 47.3 to 14.3 kilos with only minor changes in live weight and meat percentage, when supplemented by Piggy barley. The barley consumption was increased by 20.8 and 33.7 kilos respectively. Piggy barley could support adequate growth in pigs from 50 to 90 kilo live weight. It was realized by B.O. Eggum of the Danish Agricultural Research, Foulum, that the soy-bean meal sparing effect of high lysine *lys3.a* Piggy barley could reduce nitrogen pollution in pig lots by 15-20%. This is a considerable amount in Denmark, which produces about 25 million pigs annually. The explanation is that both soybean and barley meal contain large amounts of non-essential amino acids such as glutamine and proline that only can be utilized if adequate amounts of essential amino acids such as lysine, methionine and threonine are available. By introducing the improved Piggy *lys3.a* mutant into pig feeding, the protein concentration in the feed and protein (N) load on the animal could be reduced by 15-20% without compromising meat production. The decreased nitrogen (N) load on the animal spares the energy that is necessary to catabolize the surplus of non-essential amino acids through the liver and the kidneys. The 5% less carbohydrates and 2% less energy digestibility in Piggy measured in fecal trials is thus likely to be compensated by more efficient energy metabolism of the protein. We may conclude that high lysine barley mutant development has contributed to a deeper understanding of animal physiology of practical significance, both nutritionally and environmentally. It is remarkable that the scientific society that focused on protein nutrition in the 1960's identified the same mutant in the 1990's as a gene contributing to reduced nitrogen pollution by pigs.

Using barley mutants to test functionality in malting and brewing

Genetically and chemically defined mutants are not only able to contribute to the quality of raw materials but can also be used to define more precisely the functionality of a quality trait in an industrial process and provide an insight to gene expression in the seed. At Carlsberg in the 1980's, a screening analysis for percent malt modification was developed by staining cell walls (β -glucan) using the fluorescent dye calcofluor [7]. The malt modification analysis by enzymatic breakdown of barley endosperm cell walls is shown in **Fig. 5A**. Aastrup [7] screened barley for low viscosity (β -glucan) acid extracts to search for azid mutants. β -glucan negatively influences wort and beer filtration. A low β -glucan mutant M-737 from the parent variety Minerva was isolated in which β -glucan was reduced from 5.9 to 2.7%. There was a resulting reduction in endosperm cell wall thickness by two thirds (**Fig. 5B**). The M-737 mutant increased the speed of malt modification by one to two days because of less modification resistance of the cell walls during enzymatic breakdown during malting (**Fig. 5C**). It was also found that the mutant gene had a pleiotropic effect on density (softness) of the seeds (**Fig. 5D**) that could contribute to the increase in malt modification. Because of lower yield the M-737 mutant, it was not exploited for malting. However, it was of fundamental importance to understanding the connection between the raw material and the malting process, as well as to elucidating how important physico-chemical traits were connected by pleiotropy in gene expression. There is a similar story with the proanthocyanidine-free barley mutants developed at Carlsberg by Diter von Wettstein and Barbro Strid, which finally verified the cause of haze in beer [11]. But the latter mutants are now also of commercial importance.

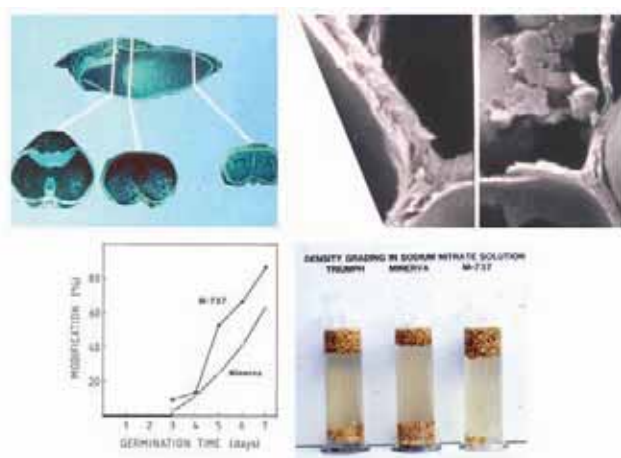

Figure 5 Functionality in barley malting studied by the low β -glucan, slender cell wall azid mutant Carlsberg M-737 in Minerva reveals faster malt modification and softer, less dense seeds (Aastrup and Munck, 1985). **(A)** Malt modification by break down of cell walls in the barley endosperm visualized by the fluorescent dye calcofluor. **(B)** Scanning electron micrograph of endosperm cell walls. left Minerva (cell wall thickness 1.6 μ ; β -glucan 5.9% d.m.), right M-737 (cell wall thickness 0.5 μ ; β -glucan 2.7% d.m.). **(C)** Malt modification% (y) with time (x) for M-737 and the parent variety Minerva analyzed by calcofluor. **(D)** Density grading with flotation for seeds of Triumph, Minerva and M-737.

The future exploitation of cereal endosperm mutants

The classic work on morphological barley mutations at the University of Lund and at the Swedish Seed Association in Svalöf that was started by H. Nilsson Ehle and Å. Gustafson in the 1930's was reviewed by Å. Gustafsson [12] and U. Lundqvist [13] at the 100 Years Jubilee of the Svalöf Institution in 1986. This genetic material is now preserved by the Nordic Genetic Research Center at Alnarp, Sweden, supplemented by the biochemical barley endosperm mutants obtained at Svalöf, Risø and Carlsberg from the 1960's to the 1980's. It is generally recognized that new gene mutations most often give negative pleiotropic effects on yield. It is rare that the mutants can be commercialized directly, as

were the erectoides "Pallas" and the early mutant "Mari" introduced by Gustafsson, and by a few of the proanthocyanidine mutants used for malting and brewing discussed by von Wettstein [14]. He also referred to the original valuable *mlo-o* powdery mildew mutation first isolated by Freisleben and Lein in 1942. Only after 45 years of intense recombination breeding could the pleiotropic leaf necrosis problem that lead to decreased yield be solved, and the advantage of the broad and stable resistance be fully exploited. It seems that the majority of scientists are rather pessimistic about the possibility to repair negative pleiotropic effects. They are searching for new genes instead of undertaking the hard work of exploiting the great flexibility of nature to find "a happy home" (gene background) for the mutant by crossbreeding. It seems that only two such successful projects in breeding high lysine varieties with improved yield and seed quality have been fulfilled since 1968: one at CIMMYT for maize [15] and the other at Carlsberg [3, 10] for barley. As was further discussed by us in these proceedings (IAEA-CN-167-300), an open holistic exploratory strategy is necessary in order to evaluate the great complexity of the pleiotropic effects of a mutant gene that can not be forecasted by limited prior scientific knowledge. A coarse overview of the phenotype (Phenome) is now possible by exploiting Near Infrared Spectroscopy [5].

ACKNOWLEDGEMENTS

We are most grateful to IAEA/FAO, Vienna and its staff for supporting endosperm mutant research by many inspiring symposia since 1968 and to Frans van den Berg for assisting us in writing this article and U. Lundqvist in correcting it. Finally, we are deeply indebted to all those who in the past have assisted us in collecting a unique barley mutant collection ideal for research in barley quality.

BIBLIOGRAPHY

- Munck, L., Karlsson, K.E., Hagberg, A., Eggum, B.O. Gene for improved nutritional value in barley seed protein. *Science* **168**, 985 (1970).
- Doll, H. Barley seed proteins and possibilities for improvement, In: *Cereal Seed Proteins, Advances in Agricultural Biotechnology, Vol. 1. Grain-Breeding*, (GOTTSCHALK, WERNER, Ed.) Martinus Nijhoff/Dr W.Junk Publ., The Hague, 207-223 (1983).
- Bang-Olsen, K, Stilling, B., Munck, L. The feasibility of high-lysine barley breeding-a summary, In: *Barley Genetics IGBS VI* (MUNCK, L., ED.) Vol. 1. Munksgaard International Publ., Copenhagen, 433-438 (1991).
- Georgi, B., Niemann, E-G., Brock, R.D., Axmann, H. Comparison of analytical techniques for seed protein and amino acid analysis: An interlaboratory comparison. In: *Seed Protein Improvement in Cereals and Grain Legumes*. Proc IAEA/FAO/GSF Symposium Neuherberg, Germany, 1978. International Atomic Agency, Vienna, 311-338 (1979).
- Møller Jespersen, B, Munck, L. Cereals and cereal products. In: *IR-spectroscopy in Foods*. (Da-Wen Sun Ed.), Academic Press/Elsevier, 275-320 (2009).
- Møller, B. Screening analyses for quality criteria in barley. Thesis. Royal Veterinary and Agricultural University (2004) <http://www.models.life.ku.dk/research/theses/>
- Aastrup, S., Munck, L. A β -glucan mutant in barley with thin cell walls. In: *New approaches to research in cereal carbohydrates*, (Hill, R.D., Munck, L., Ed.), Progress in Biotechnology Vol. 1, Elsevier Publishers, Amsterdam, 291-296 (1985).
- Munck, L., Møller, B., Jacobsen, S., Søndergaard, I. Near Infrared Spectra indicate specific mutant endosperm genes and reveal a new mechanism for substituting starch with β -glucan in barley. *J. Cereal. Sci.* **40**, 213 (2004).
- Bach Knudsen, K.E., Munck, L. The feasibility of breeding barley for feed quality. Proc. IGBS IV, Edinburgh, 1981, Center for International Consultancy, University of Edinburgh, Scotland, 320-329 (1981).
- Munck, L. The case of high lysine barley breeding, *Barley: Genetics, Biochemistry, Molecular Biology and Biotechnology*, (Shewry, P.R Ed.), C.A.B: International, Wallingford, Oxon, UK, 573-603 (1992).
- Wettstein, D., Nilan, R.A., Ahrenst-Larsen, B., Erdal, K., Ingversen, J., Kristiansen, K.N., Larsen, J., Outtrup, S.E., Ullrich, S.E. Proanthocyanidin-free barley for brewing: progress in breeding for high yield and research tool in polyphenol chemistry. *Tech. Q. Master Brew. Assoc. Am.* **22**, 41 (1985).

12. Gustafsson, Å. Mutation and gene recombination - principal tools in plant breeding. Svalöf 1886-1986 Research and Results in Plant breeding, (Olsson,G., Ed.), 76-84 (1986).
13. Lundqvist, U. Barley mutants - diversity and genetics. *IBID*, 85-88 (2004).
14. Von Wettstein, D. The future of barley as an experimental organism. Barley Genetics IGBS VI, Helsingborg, Sweden, 1991, (Munck,L., Ed.) Vol. 2. Munksgaard International Publ., Copenhagen, 1087-1098 (1992).
15. Vasal, S.K. High quality protein corn. Speciality corns (Hallauer,A.R. Ed.), CRC press, Boca Raton, FL, USA, 80-121.

Creation and Evaluation of Induced Mutants and Valuable Tools for Pepper Breeding Programmes

N Tomlekova^{1,*}, V Todorova¹, V Petkova¹, S Yancheva², V Nikolova¹, I Panchev³ & E Penchev⁴

Abstract

Advances in plant molecular biology and screening techniques, integrated with mutation technologies, have allowed for study and better utilization of mutant lines. Application of physical and chemical mutagens in pepper breeding programmes has created mutants with applied value - increased β -carotene levels in fruit, male sterility, lack of anthocyanins, determinate habit, altered fruit shape and changes in fruit position. Recombinant inbred lines (RILs) have been developed and different mutant genes combined in the same genotypes. Mutants demonstrating potential for increased β -carotene levels were selected and exploited as parents for the development of hybrids. Dramatic increases in β -carotene content were found in some of these F₁ hybrids. Results obtained from cytological, biochemical and physiological studies of carotenoid levels, β -carotene hydroxylase activity and chlorophylls, together with observations of the phenotypes of plants and fruits suggested that several mutant lines could be exploited in breeding programmes. Molecular studies allowed us to establish a marker for orange fruit colour useful for MAS.

Introduction

The market justifies the breeding of new cultivars combining high-yield, attractive fruit and high nutritional value. Bulgaria has a leading position in the development of pepper cultivars with improved quality and agronomic characters. Increasing biodiversity by conventional breeding methods has been a difficult and long process. Until recently, pepper improvement programmes were based mainly on utilizing natural sources of germplasm and cross breeding, male sterility and heterosis effects. The breeding of important agricultural characters (yield, resistance to pests and diseases, etc.) have to be performed in parallel with breeding for nutritional value. Our breeding strategy aimed at increasing carotenoid levels, and was also directed towards the selection of other traits, such as productivity, male sterility, plant habit, fruit size and shape, and lack of anthocyanins. Modern techniques for plant characterization, particularly those of molecular biology, were integrated with conventional methods to generate and characterize useful induced mutations [1, 2, 3]. The purpose of this study was the creation and evaluation of valuable pepper mutants through appropriate methods for crop genetic improvement.

Materials and Methods

Investigations were carried out in 2002–2008 at the Maritsa Vegetable Crops Research Institute, Plovdiv, Bulgaria, with *Capsicum annuum* L. sweet pepper cultivars (cv.) and breeding lines (bl.) for fresh consumption.

Mutants (M) obtained by Tomlekova and colleagues [4] after Ethyl methansulphonate (EMS) and Co⁶⁰ Gamma-ray treatment of wild-type

(WT) cv. Hebar were identified by observation of phenotypic alterations. Anthocyanin-free plants were observed at the seedling stage and their phenotype has been further screened.

Physical treatments (120Gy X-rays) on dry seeds of red-fruited (*rf*) local cv. Pazardzhishka kapiya 794 led to obtaining of a mutant (*of*, M^{of}), with orange-coloured mature fruit [5], and a cv. Oranzheva kapiya was developed by Daskalov and colleagues [6].

Mutants lacking anthocyanins (*al*) were obtained following gamma irradiation of cv. Zlaten medal 7. Mal plants with early and high yield, more attractive fruit and better flavor, were developed in cv. Albena by Daskalov [7]. After the incorporation of the mutant character orange fruit color (*of*) into genotypes bearing the *al* mutation a series of recombinant inbred lines (RILs; genotypes 32, 33, 34, 35, 36) were developed (M^{of,al}) [5, 9]. Near isogenic lines (NILscolournge) were advanced to M12-15 and used for crosses with the corresponding WT, to produce WTxM and MxM F₁ hybrids. Mutant genes introduced into elite pepper M^{of} material were studied for their influence on β -carotene content in mature fruit.

Male sterile mutant Zlaten medal *ms8* (28) (M^{ms8}) had been obtained by the application of 120Gy R \ddot{o} -rays to the fertile (*f*) local cv. Zlaten medal 7 (WT^f) [8, 10, 15]. The bl. 28^{ms8} and 30^{Ms.of,al} were crossed by us to combine *of*, *al*, and *ms8*. The type of segregation (fertile (*f*); sterile (*s*) plants) was defined in 124 F₂ plants. These plants were obtained from seeds produced from different isolated fruits and plants of the same cross. Pollen fertility or lack of pollen in anthers in the blossoming period was assayed in 4% acetocarmine and glycerol (1:1) and microsporogenesis by squashing anthers in 4% acetocarmine.

Fruits from 20 individual plants of each genotype listed in **Table 1** at the same stage of botanical maturity were used for biochemical analyses of β -carotene content using column chromatographic absorption [11]. A three-year biochemical selection of bl. toward stable β -carotene levels was conducted.

Photosynthetic pigments, chlorophylls (*Chl*), and total carotenoids in fruit were also analyzed at botanical maturity, by the method of Wettstein [12]. Analysis of the inheritance of β -carotene content in fruit was done according to Genchev, *et al.* [13].

The β -carotene hydroxylase (*CrtZ*) activity was analyzed in crude extracts of green and mature lyophilized fruit of one WT and two M lines, especially searching for differences in β -carotene levels by detection of the conversion of β -carotene (orange pigment) to β -cryptoxanthin (yellow xanthophylls). Molecular characterization of the genes encoding two hydroxylases *CrtZ* and *CrtZ-2* was conducted. Genomic DNA from M^{of} and WT^f was isolated using CTAB protocol, and used for gene-specific PCR according to FAO/IAEA protocols [14].

Results and Discussion

The population raised from M₁ seeds from WT cv. Hebar treated with EMS and Co⁶⁰ irradiation presented several morphological changes in the M₁ generations (**Fig. 1**).

Phenotypes were screened in M₂ plants and mutant characters selected

¹ Department of Breeding, Variety Maintenance and Introduction, Maritsa Vegetable Crops Research Institute, Plovdiv, Bulgaria

² Agricultural University, Plovdiv, Bulgaria

³ Faculty of Biology, Sofia University, Sofia, Bulgaria

⁴ Dobroudja Agricultural Institute, General Toshevo, Bulgaria

* Corresponding author. E-mail: tomleкови@mail.bg

as valuable were fixed in further generations. A mutant with determinate habit was selected and maintained.

Selected M plants included genotypes lacking anthocyanins, those with erected fruit, erected fruit in a bunch and altered fruit shape. Confirmation of these traits was performed until the M_4 generations for further development of advanced mutant lines.



Figure 1 Induced pepper mutants in the M_4 generations following EMS treatment and Co^{60} irradiation.

The cytological results (Fig. 2 a, b, c) undertaken on the F_2 segregating progeny (28x30) showed that the average ratio of fertile: sterile plants was 4.24:1, which is close to the expected 3:1 ratio. The expression of the mutant gene *ms8* was stable and no pollen formation in the anthers of the studied sterile plants in both - the mother line 28 and the sterile F_2 plants was observed, which is consistent with previous investigations [8]. The anthers were deformed and without pollen grains. Results of the meiotic analysis in pollen mother cells of sterile plants from line 28 revealed that lethality of the cells occurred after second telophase, by blocked cytokinesis and tetrad formation in the ms_8ms_8 plants was not observed.



Figure 2 Anthers of F_2 plants: fertile (a) with pollen grains (b) and sterile (c).

The biochemical data obtained in 2005 of the orange-fruited mutants demonstrated that the β -carotene content was genotype-dependant (Table 1). Comparative analyses between the groups of M^{of} and WT^{rf} revealed much higher accumulation of β -carotene in the orange-fruited (*of*) lines. All M^{of} had higher β -carotene content (12.57 to 19.58 mg/100 g fresh matter (*fm*)) than the WT^{rf} (bl. 28, 31), which had red fruit (*rf*; 6.68 and 4.30 mg/100 g fresh matter (*fm*)). The β -carotene levels in different F_1 hybrids ($M^{of} \times WT^{rf}$; $M^{of} \times M^{of}$) were also greater than the WT^{rf} . The highest concentrations were obtained when two parental M^{of} were hybridized. The β -carotene content was the greatest in the F_1 [35x17] hybrid (41.05 mg/100 g *fm*). The very high β -carotene levels of the F_1 hybrids were preserved in three consecutive years, despite of the variation in this trait. Higher β -carotene levels in most of F_1 hybrids were established combined with lower variation in this trait compared to the corresponding parents.

Genotypes that participated in the studied crosses were selected for exploitation as parents for the development of hybrids. Line 35, followed by lines 31 and 30 were recommended. The F_1 hybrids obtained with bl. 31 could contribute to improved market performance due to the preference of red-fruited peppers. Variability in the β -carotene content of M^{of} with the same origin indicated that besides this mutation, there are other genetically-determined factors contributing to increase in this compound, reported for other pepper genotypes [19]. The presence of mutant gene in M^{of} , the observed pyramiding of responsible genes and their interaction in some of the F_1 hybrids demonstrated a greater potential for increased β -carotene levels. Despite the statistical significant difference (95%) between WT^{rf} and M^{of} groups, the inheritance of the β -carotene trait varied from partial dominance to over dominance in the same F_1 hybrids. In each WT^{rf} and M^{of} genotype a further selection towards the β -carotene levels was conducted to decrease the variation of the target (data not shown).

Table 1. Variation in β -carotene content per 100g fresh fruit in individual plants of pepper genotypes

Genotype-Parents and F1 hybrids		β -carotene mg/100 g <i>fm</i>		Error of the difference		
Line number	Fruit color	\bar{x}	$\pm S$	$t_{\text{experimental}}$	VC%	
P_1	28	red	6.68***	0.71	4.53 (F_1 & P_1)	35.32
P_2	29	orange	12.57***	1.01	4.75 (P_2 & P_1)	26.74
F_1	[28x29]	red	12.20	0.98	-0.26 (F_1 & P_2)	25.60
P_1	28	red	6.68***	0.71	4.65 (F_1 & P_1)	35.32
P_2	30	orange	15.84***	1.55	5.36 (P_2 & P_1)	31.00
F_1	[28x30]	red	17.01	2.10	0.44 (F_1 & P_2)	27.64
P_1	32	orange	12.80***	1.38	6.77 (F_1 & P_1)	35.98
P_2	31	red	4.30***	0.45	-5.81 (P_2 & P_1)	28.05
F_1	[32x31]	red	23.98***	0.89	19.62 (F_1 & P_2)	10.54
P_1	35	orange	13.62**	1.07	3.26 (F_1 & P_1)	24.92
P_2	31	red	4.30***	0.45	-7.98 (P_2 & P_1)	28.05
F_1	[35x31]	red	27.87***	4.23	5.53 (F_1 & P_2)	26.32
P_1	32	orange	12.80*	1.38	2.68 (F_1 & P_1)	35.98
P_2	17	orange	19.58*	2.00	2.78 (P_2 & P_1)	32.33
F_1	[32x17]	orange	18.89	1.79	-0.25 (F_1 & P_2)	25.13
P_1	35	orange	13.62***	1.07	11.36 (F_1 & P_1)	24.92
P_2	17	orange	19.58*	2.00	2.62 (P_2 & P_1)	32.33
F_1	[35x17]	orange	41.05***	2.16	7.28 (F_1 & P_2)	10.54

Df=18; t_{critical} $P_{5\%}$ (2.1), $P_{1\%}$ (2.88), $P_{0.1\%}$ (3.92); VC=variation coefficient%; \bar{x} =Average value; $\pm S$ =Error of \bar{x}

The quantity of chlorophylls, and total carotenoid content, was genotype-dependent. Effects of mutation in chlorophylls and total carotenoids in fruit were detected. *Chl a* contributed most to the increase of the total chlorophylls. Despite the increase in β -carotene content, the rest of carotenoids contributed to a decrease in the total carotenoid content (data not shown).

On the basis of the data for β -carotene and total carotenoid levels, a hypothesis for a mutation that affected a gene encoding an enzyme responsible for hydroxylation of β -carotene to β -cryptoxanthin was erected. Significantly less hydroxylase (e.g. *CrtZ*) enzyme activity in ripe fruit was noted in the M^{of} compared to the control WT^{rf} (Fig. 3). This enzyme is responsible for the hydroxylation of β -rings and the conversion of carotenoids into xanthophylls. Thus, data from analysis of enzyme activity support the hypothesis.

Molecular studies have also supported this hypothesis. PCR reactions with different gene-specific primers were undertaken for two hydroxy-

lase structural genes known to be involved in pepper biosynthetic pathway (Table 2).

Both hydroxylases are expressed in pepper [16], in tomato [17], and localized in the green tissue and flower (Ronen, *et al.*, 2000, quoted by [18]). A band from *CrtZ* was amplified using primer combinations *CrtZ*-C, D, D/C and E in all WT^f but was absent in M^{of} (Fig. 4). Fragments amplified from *CrtZ-2* in all WT^f and M^{of} showed monomorphic DNA profiles. This result was confirmed by a following sequencing of fragments isolated from *CrtZ* and *CrtZ-2* after amplification with the *CrtZ*-C/C.

Two DNA fragments were amplified and isolated from each WT^f corresponding to *CrtZ-2* and *CrtZ* genes and a unique fragment - from M^{of} corresponding to *Crt-2*. A mutation occurring in the 3'-terminal region in the mutant was very probable. The noted primer combinations could be efficient as gene-marker for selection performing towards orange fruit color in M^{of}.

Table 2. PCR amplification with specific primers for the gene *CrtZ* and *CrtZ-2*.

Gene amplified	Primer design by cDNAbp	Primer sequences	Results from fragments
<i>CrtZ</i> -C/C	607-885	F GAG CTG AAC GAT ATT TTT GCC	Band ~620bp from <i>CrtZ</i> -C/C in WT; absent in M;
<i>CrtZ-2</i> -C/C	586-864	R TAG GAA CAA GCC ATA TGG GA	~760bp from <i>CrtZ-2</i> -C/C present in WT and in M
<i>CrtZ</i> -D/C	526-885	F AGA TGG GCG CAT AGA GCA CTA	Band from <i>CrtZ</i> -D/C ~700bp in WT;
		R TAG GAA CAA GCC ATA TGG GA	absent in M
<i>CrtZ</i> -D/D	526-866	F AGA TGG GCG CAT AGA GCA CTA	Band from <i>CrtZ</i> -D/D ~750bp in WT;
		R ACC CCA TCA AAT TTG TCC GA	absent in M
<i>CrtZ</i> -E/E	20-866	F CGT ACA TGG CTG CTG AAA TT	Band from <i>CrtZ</i> -E/E ~1400 in WT;
		R ACC CCA TCA AAT TTG TCC GA	absent in M
<i>CrtZ</i> -C/D	607-866	F GAG CTG AAC GAT ATT TTT GCC	Band from <i>CrtZ</i> -C/D ~580 in WT;

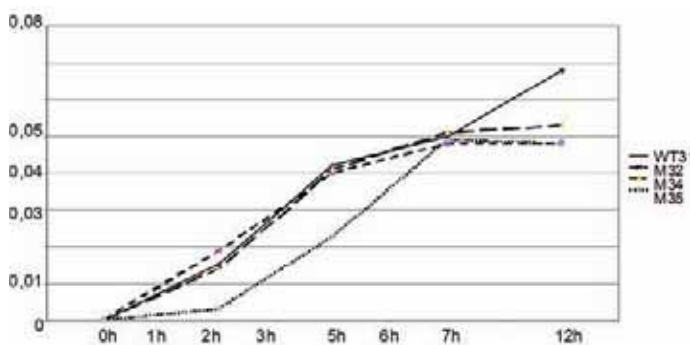

Table 2. PCR amplification with specific primers for the gene *CrtZ* and *CrtZ-2*.

R ACC CCA TCA AAT TTG TCC GA absent in M

* monomorphism (-); polymorphism (+)

Figure 3 *CrtZ* activity registered in pepper fruit of WT^f and M^{of} at botanical maturity. x - time of registration of the enzyme activity - 2, 5, 7, 12, 24 hours after starting of the reaction; y - decrease of absorption values.

Conclusions

Application of EMS and Co⁶⁰ created mutations of applied value, such as determinate habit, lack of anthocyanins, and changes of fruit shape and position. Recombinant inbred lines were developed and different mutant genes were combined in the same genotypes.

Cytological studies demonstrated the stability of the expression of the gene *ms8* determining male sterility.

Fruit from pepper mutants and wild-type plants differed in their carotenoid content. In the fruit of the mutant lines, β -carotene levels increased dramatically. Conversely, a decrease in the accumulation of total carotenoids, due to a decrease in xanthophyll formation, was found in the mutants. A reduction in *CrtZ* enzyme activity, which converts the β -carotene to β -cryptoxanthin, was observed in the mutants. Molecular investigations suggested changes occurring in the 3'-terminal region of the *CrtZ* gene could be responsible for reducing the hydroxylase enzyme activity of the mutants.

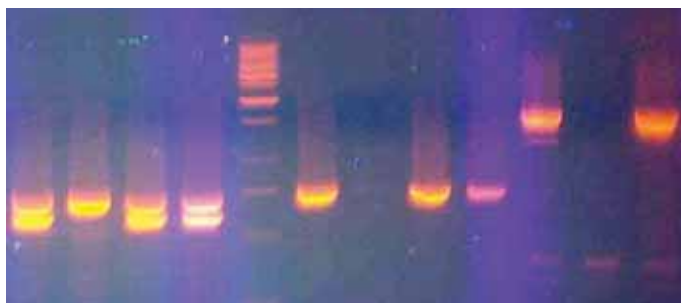

Figure 4 PCR fragments in sweet pepper WT^f and M^{of} with gene specific primer combinations: 1-4-*CrtZ* and *CrtZ-2* C/C (WT₁, M, WT₂, WT₃); 5-DNA Ladder (250, 500, 750, 1000 bp); 6-9-*CrtZ* D/D (WT₁, M, WT₂, WT₃); 10-12-*CrtZ* E/E (WT₁, M, WT₂).

This study allowed breeding strategies to exploit different mutant lines for developing F₁ hybrids with increased β -carotene content. The C and D/C combinations could be used as a marker for high β -carotene for performing marker-assisted selection. The presence of a fragment from *CrtZ-2* amplified in the mutant genotypes by primer combination C is very useful as an internal standard (i.e. multiplex) co-dominant allele-specific marker (null).

ACKNOWLEDGEMENTS

Work was performed within the CRP D23024 on Physical Mapping Technologies for the Identification and Characterization of Mutated Genes Contributing to Crop Quality Research Contract N°12227 with FAO/IAEA.

BIBLIOGRAPHY

- Mohan, M., Nair, S., Bhagwat, A., Krishna, T.G., Yano, M. Genome mapping, molecular markers and marker-assisted selection in crop plants. *Molecular Breeding* **3**, 87-103 (1997).
- Joshi, M., Khalatkar, A. Experimental mutagenesis in *Capsicum annuum*: I. Effect of different doses of gamma radiations on capsule and seed production. ISHS Acta Horticulturae. 111 Symposium on Vegetable and Flower seed Production (1998).
- Lavi, U. Mutant Germplasm Characterization using Molecular Markers, Working materials, FAO/IAEA (2002).
- Tomlekova, N., Todorova, V., Daskalov, S. Creating variation in pepper (*Capsicum annuum* L.) through induced mutagenesis. *Plant Sciences* **44**, 44-47 (2007).
- Daskalov, S. Experimental mutagenesis and mutation breeding in pepper. *Capsicum Newsletter* **10**, 13-20 (1991).
- Daskalov, S., Baraliev, D. Oranzheva kapiya: A new cv. in sweet pepper with increased beta-carotene /provitamin A/ content. *Mutation Breeding Newsletter* **39**, 9-10 (1992).
- Daskalov, S. Alben: a new mutant cultivar in sweet pepper for early and mid-early field, **12**, 22 (1975).
- Daskalov, S. Three new male sterile mutants in pepper (*C. annuum* L.). *C. R. Acad. Sci. Agr.* **6**, 39-41 (1973) (in Bulgarian).

9. Daskalov, S., Chalukova, M., Baraliev, D., Lukarska, E. Biochemical investigations of an induced beta orange mutant in sweet pepper (*Capsicum annuum* L.) and developing cultivars with increased beta-carotene content. *Proceedings of Eucarpia IXth Meeting on Genetics and Breeding on Capsicum and Eggplant*, Budapest, Hungary, August 21–25, 124–126 (1995).
10. Daskalov, S., Poulos, J.M. Updated Capsicum gene list. *Capsicum and Eggplant Newsletter*, **13**, 16-26 (1994).
11. Manuelyan, H. Improved method of chromatographic separation of carotene in tomatoes. *Hort. Vitic. Sci.* **42**, 53-58 (1967) (in Bulgarian).
12. Wettstein, F. *Exper. Cell Res.* **12** (1961).
13. Genchev, G., Marinkov, E., Yovcheva, V., Ognyanova, A. Biometrical methods in plant growing, genetics and breeding. *Zemizdat*, Sofia **322** (1975) (in Bulgarian).
14. FAO/IAEA, Working materials on Mutant Germplasm Characterization Using Molecular Markers, ISSR protocol, FAO/IAEA Interregional Training Course, Division of Nuclear Techniques in Food and Agriculture, Vienna, October (2001).
15. Daskalov, S. Investigations on induced mutants in *Capsicum annuum* L.3. Mutants in the variety Zlaten medal. *Genetics and Plant Breeding* **6**, 419-424 (1973) (in Bulgarian).
16. Bouvier, F., Keller, Y., D'harlingue, A., Camara, B. Xanthophyll biosynthesis: molecular and functional characterization of carotenoid hydroxylases from pepper fruits (*Capsicum annuum* L.). *Biochim. Biophys. Acta.* **1391**, 320-328 (1998).
17. Hirschberg, J. Molecular Biology of Carotenoid Biosynthesis, Carotenoids 3 Biosynthesis and metabolism. 149-194 (1998).
18. Hirschberg, J. Carotenoid biosynthesis in flowering plants. *Current Opinion in Plant Biology* **4**, 210-218 (2001).
19. Timin, O. Creation of sweet pepper F₁ hybrids with higher biochemical content on sterile basis. PhD Thesis, Moscow (2005) (in Russian).

Induced Mutagenesis for Oil Quality Enhancement in Peanut (*Arachis hypogaea* L.)

S B Kaveri* & H L Nadaf

Abstract

Increasing the ratio of oleic to linoleic acid (O/L) in peanut (*Arachis hypogaea* L.) significantly improves the nutritional and quality attributes of the crop. The lack of sufficient genetic variation in fatty acid composition, particularly the O/L ratio, in peanut germplasm and presently grown cultivars make the creation of such variability necessary. Mutation breeding of peanut was initiated with the objective of identifying stable peanut mutants with altered fatty acid composition for improved oxidative stability and nutritional quality. Seeds of peanut cultivars 'GPBD-4' and 'TPG-41' were treated with γ -radiation and/or ethyl methane sulphonate (EMS). Randomly selected mutants were advanced based on single plant selection up to the M_4 generation and the harvest of M_4 plants was evaluated for fatty acid composition by gas chromatography. Highly significant variation for palmitic, stearic, oleic, linoleic and arachidic acid was observed. EMS (0.5%) and 200Gy treatments were found to be effective in increasing the variability in fatty acid content in GPBD-4 and TPG-41, respectively. The variability was skewed towards high levels of oleic acid (38-67%) and low levels of linoleic acid (15-41%). Mutants selected for improved oil quality were significantly superior for O/L ratio and had reduced palmitic acid. Oil with reduced palmitic acid and increased O/L ratio is desired nutritionally. Hence, these mutants can be exploited for the improvement of oil quality. The mutants GE-87 and T3-105 recorded the highest O/L ratios, of 4.30 and 3.91, compared to control values of 1.75 and 2.60, respectively. A significant negative correlation between oleic acid and linoleic acid, palmitic acid and iodine values, and weak inverse relationship with oil content indicates the possibility of selection for improved fatty acid composition. These high oleic acid lines could be utilized further in breeding programmes for improvement of peanut oil quality.

Introduction

The peanut (*Arachis hypogaea* L.) is cultivated in most tropical and subtropical regions. Because of extensive production for cooking oil, the quantity and quality of the oil are extremely important considerations in cultivar development. Peanut genotypes contain approximately 50% oil [1], which becomes rancid upon exposure to air and heat due to oxidation [2, 3]. Consequently the shelf life of oil and products that contain peanut and peanut oil, is limited. The oxidative stability and shelf-life of peanut oil is influenced by the concentrations of specific fatty acids [4, 5]. In general, saturated fatty acids are less susceptible to oxidation than less saturated fatty acids. Two fatty acids, oleic and linoleic, comprise over 80% of the oil content of peanut. Of these, linoleic acid is less saturated and less stable than oleic acid. There is a strong negative correlation between linoleic acid content and oil stability in peanut [6, 7]. In addition to increasing the stability of peanut oil, increasing the O/L ratio appears to have health benefits as well. Research has associated high oleic acid with lowered blood serum cholesterol, especially low density

lipoproteins (LDL) in humans [8] and a reduction in recurrent myocardial effects when oleic acid levels are increased in plasma fatty acids [9].

Increasing the O/L ratio in peanut seems to have positive effects on peanut quality and nutritional value. The majority of peanut cultivars average 55% oleic acid and 25% linoleic acid [10]. The available germplasm and breeding lines screened to date have indicated very limited genetic variability for O/L ratio (0.8-2.50). No genotypes were found in either National (NRCG, Junagadh, India) or International (ICRISAT, Hyderabad, India) germplasm collections of peanut with high O/L ratios comparable to the natural mutants isolated in Florida, USA [11]. These mutants as well as their derivatives are highly protected and patented. Thus they are not available for use in international breeding programmes. Therefore, it is essential to create new genetic variability for this value-added trait for the improvement of peanut oil quality. The occurrence of natural mutations, possibility of induced mutations and significant achievements made in different oilseed crops suggest that if concerted efforts are made with the specific objective of increasing oleic acid through induced mutations, it is achievable.

The present study was initiated with the objective of developing peanut lines with a beneficially altered fatty acid composition in two indigenous peanut varieties using induced mutagenesis.

Materials and Methods

Two Spanish Bunch genotypes viz., GPBD-4 and TPG-41 were used for mutagenic treatments.

Mutagen treatments

Seeds of peanut cultivars GPBD-4 and TPG-41 were treated with γ -radiation and ethyl methane sulphonate (EMS). Uniform size seeds of each cultivar were used for treatment. Treatments (500 seeds per treatment) consisted of two different doses of γ -radiation (200 and 300Gy) and EMS (0.5%). Untreated seed of the respective cultivars were used as a control. Seeds were irradiated with γ -radiation at Bhabha Atomic Research Center (BARC) Mumbai, India. EMS solution was prepared in 0.1 M phosphate buffer (pH = 7.0). Seeds were presoaked in distilled water for eight hours to allow uptake of EMS. Presoaked seeds were then treated with EMS for two hours at room temperature in cloth bags. Treated seeds were rinsed in running tap water for four hours and sown in field plots along with untreated controls. The seeds were sown in a randomized complete block design, in five replications, with spacing of 30cm between the rows and between plants. Recommended agricultural practice was followed. The M_1 plants were harvested on a single plant basis. In the M_2 generation one hundred progenies of each treatment in both genotypes were selected randomly and advanced to the M_4 generation on single plant basis. The harvest of M_4 plants was used for fatty acid analysis.

Fatty acid analysis

In the M_4 generation a hundred mutant progenies per treatment were analyzed for fatty acid composition, following the extraction and esteri-

National Seed Project, Seed Unit, University of Agricultural Sciences, Dharwad, Karnataka, India

* Corresponding author. E-mail: kaveri_pnut@rediffmail.com

fication method [12]. The oil content of selected mutants with high O/L ratios was determined by nuclear magnetic resonance techniques [13].

Gas chromatography analysis

A gas chromatograph, model GC-2010 equipped with automatic sample injector AOC-20i, flame ionization detector (Shimadzu, Kyoto, Japan), fitted with a narrow bore capillary column Rtx-wax (film thickness-0.25 μ m; I. D.-0.25 mm; length-30 m) was used to separate methyl esters. The initial column temperature was set at 170°C and held for three minutes, then programmed to increase by 10°C per minute to a final temperature of 230°C, at which it was held for one minute. Injector and detector temperatures were both set at 250°C. The flow rates for nitrogen (carrier gas), hydrogen and air were 45, 40 and 400 ml per minute, respectively. The fatty acid methyl esters were identified by comparison with the retention times of a standard methyl ester fatty acid mixture (Sigma, Aldrich). The concentration of each fatty acid was determined by normalization of peak areas and reported as per cent of the total fatty acids.

Statistical analysis

Mean, range and variance were calculated in the M_4 generation for each mutagenic treatment and control to determine the extent of variability created. Two-way analysis of variance was computed to ascertain fatty acid differences in the M_4 generation of all treatments and control using SPSS (version 10). Significant differences between and within treatments means were determined using least significant difference (LSD) values. The oil quality parameters viz., O/L ratio, unsaturated to saturated ratio (U/S) and iodine value (IV) were computed as follows:

1. O/L ratio = % oleic (C18:1) / % linoleic (C18:2)
2. U/S ratio = % (oleic + linoleic + ecosenoic) / % (palmitic + stearic + arachidic + behenic + lignoceric).
3. Iodine value = (% oleic x 0.8601) + (% linoleic x 1.7321) + (% ecosenoic x 0.7854) [14]

In high oleic acid mutants, simple correlation coefficients were also calculated for fatty acid content and different quality parameters using SPSS (version 10).

Results and Discussion

Variability in fatty acid composition

The utility of any vegetable oil is largely determined by its fatty acid composition. Therefore, genetic variability in fatty acid composition is pre-requisite for any breeding programme aimed towards oil quality improvement. As a result of mutagenic treatments, a wide range of variability for all the fatty acids was observed in M_4 seeds. Oleic acid and linoleic acid represented ca. 90% of the fatty acid profiles of peanut and exhibited more variability compared to other fatty acids (**Table 1**). Mean values of treatments particularly in GPBD-4 were higher than corresponding control mean values for most of the traits under study. Interestingly, the range and variance for oleic and linoleic acid was many fold higher than to the parents (control), indicating substantial induced genetic variability for these traits. EMS (0.5%) induced greatest variability for important oil quality traits in GPBD-4, followed by the 300Gy and 200Gy irradiation treatments. By contrast, in TPG-41, doses of 200Gy and 300Gy induced greatest variability for important oil quality traits, followed by EMS (0.5%). These results indicated differential responses of the genotypes to mutagen treatment and the potential of mutagens to create genetic variability for oil quality traits in peanut. The cultivar TPG-41 was found to be more sensitive to mutagenic treatments than GPBD-4, as higher variance values were recorded. Thus it is suggested that selection of a mutagen-sensitive genotype and appropriate mutagens could create maximum genetic variability. The highest mean and range for O/L ratio was observed in TPG-41 (2.40) and GPBD-4

(1.0-4.3) treated with EMS (0.5%), respectively. The iodine value, which is inversely proportional to oil stability, was found to be low in mutagenized populations compared to controls, and the lowest mean iodine value was observed in TPG-41 treated with 200Gy (90.70). Treatment

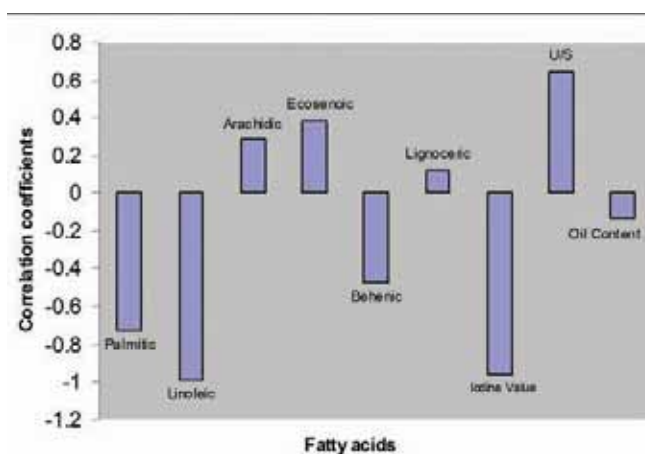

Figure 1 Correlation between oleic acid and other fatty acids in peanut.

Table 1. Fatty acid variation in M_4 generation in peanut induced by mutagenesis

Genotypes	Fatty acid	Treatments	Mean	Range	Variance
GPBD-4	Oleic acid (O)	Control	50.57	49.0-52.0	0.8
		EMS (0.5%)	54.73	41.0-66.6	26.91
		200 Gy	55.66	48.0-65.0	9.46
		300 Gy	52.19	44.0-65.0	13.52
TPG-41	Oleic acid (O)	Control	58.00	57.0-58.0	0.35
		EMS (0.5%)	56.40	48.0-65.0	16.25
		200 Gy	58.61	38.0-64.0	42.10
		300 Gy	59.08	39.0-65.0	32.42
GPBD-4	Linoleic acid (L)	Control	29.09	28.0-30.0	0.72
		EMS (0.5%)	26.93	15.0-36.0	20.23
		200 Gy	28.96	16.0-31.0	7.64
		300 Gy	28.20	16.0-34.0	9.97
TPG-41	Linoleic acid (L)	Control	22.51	21.0-23.0	0.75
		EMS (0.5%)	24.40	16.0-31.0	12.07
		200 Gy	26.45	18.0-41.0	32.30
		300 Gy	26.21	17.0-41.0	23.88
GPBD-4	O/L	Control	1.74	1.0-2.0	0.01
		EMS (0.5%)	2.03	1.0-4.3	0.35
		200 Gy	1.86	1.5-4.0	0.19
		300 Gy	1.56	1.0-4.0	0.25
TPG-41	O/L	Control	2.58	2.0-2.7	0.02
		EMS (0.5%)	2.40	1.0-4.0	0.30
		200 Gy	2.18	1.0-3.5	0.35
		300 Gy	2.70	1.0-3.8	0.29
GPBD-4	Iodine value	Control	94.63	93.0-96.0	1.06
		EMS (0.5%)	91.21	82.0-101	12.90
		200 Gy	93.36	84.0-95.0	5.39
		300 Gy	94.63	83.0-100	1.06
TPG-41	Iodine value	Control	91.00	88.0-90.0	1.04
		EMS (0.5%)	91.60	85.0-97.0	7.65
		200 Gy	90.70	88.0-95.0	19.66
		300 Gy	93.66	87.0-103	13.12

Table 2. Fatty acid profile and oil content of mutants with the greatest O/L ratio selected in the M₄ generation

Mutants	Fatty acid profile (%)										Oil content (%)	
	16:0	18:0	18:1	18:2	20:0	20:1	22:0	24:0	18:1/ 18:2	IV ^a		U/S ^a
GE-87 ^b	8.25	0.97	66.58	15.53	1.50	1.58	3.70	1.87	4.30	85.41	5.14	47.35
GE-112	7.32	2.78	64.94	15.78	3.12	0.70	3.86	1.45	4.12	83.74	4.40	47.10
GE-53	9.38	2.38	63.40	17.32	1.46	1.30	3.10	1.61	3.66	85.55	4.57	46.86
G2-229	7.76	1.77	65.32	16.53	1.24	1.60	4.01	1.74	3.95	86.07	5.05	47.26
G2-123	7.30	3.75	63.81	16.66	1.85	1.06	4.07	1.48	3.83	84.57	4.42	47.08
G3-18	7.98	2.70	63.96	16.27	1.70	1.50	3.95	1.92	3.93	84.37	4.48	48.20
G3-75	8.32	2.21	65.02	16.08	1.38	1.47	3.71	1.77	4.04	84.93	4.75	46.75
G3-280	7.85	3.07	62.08	18.60	1.73	1.21	4.06	1.42	3.34	86.56	4.52	46.24
TE-231	8.62	2.04	64.22	17.46	1.34	1.22	3.15	1.52	3.68	86.44	4.97	47.00
T3-105	7.50	4.26	65.24	16.70	1.76	0.80	2.62	1.10	3.91	85.67	4.80	46.25
GPBD-4	10.12	1.80	50.67	29.00	1.65	1.30	3.64	1.71	1.75	94.83	4.28	47.70
TPG-41	10.85	1.77	58.67	22.61	1.34	1.21	3.10	1.73	2.60	90.58	4.40	45.25
LSD _{0.05}	1.02	0.95	2.36	1.84	0.65	0.48	0.51	0.44	0.98	2.16	0.88	1.13

^a IV-iodine value, U/S-ratio of unsaturated to saturated fatty acids

^b First letter and second letter/digit indicates the genotype and mutagen treatment, respectively (GE-87: GPBD-4, EMS treatment, progeny 87)

with EMS in higher concentrations, as well as combined treatment of both γ -radiation and EMS, increased the variability for fatty acids particularly oleic and linoleic acid content in soybean oil [15].

In the M₄ generation, out of 55 distinct mutants identified for altered fatty acid composition, the 10 mutants with greatest O/L ratio are presented in **Table 2**. The most distinguishable feature of the fatty acid profiles of these mutants was the relative contribution of oleic and linoleic acids to the total. The 10 mutants were significantly superior in O/L ratio, which ranged from 3.34 - 4.27 compared to 1.75 (GPBD-4) and 2.60 (TPG-41). The mutant GE-87 recorded the highest O/L ratio of 4.30, highest U/S ratio of 5.14, and lowest iodine value of 85.41, with an oil content of 47.35% comparable to the control (47.70%). The best mutant in the TPG-41 mutagenized population was T3-105 recording an O/L ratio of 3.91, a U/S value of 4.8, an iodine value of 85.67, and comparable oil content to its parent. The rest of the mutants had O/L ratios of 3.44 to 4.12. Palmitic acid, the principal saturated fatty acid in plant oils, is known to be associated with increased levels of blood cholesterol, arteriosclerosis and high risk of coronary heart disease [16]. Interestingly, the mutants identified here had significantly reduced palmitic acid. The mutant GE-112 recorded the lowest palmitic acid content of 7.32%, compared to a parental value of 10.12%. These results clearly indicate that the mutants are significantly superior for oil quality and nutrition. Mutation breeding has been extensively applied to modify the fatty acid composition of soybean [17] and canola [18].

Correlation among fatty acids and oil content

The correlation coefficient between oleic acid and other fatty acids and total oil content are presented in **Fig. 1**. The highest correlations were noted for the percentage oleic and linoleic acids ($r = -0.99$) and for percentage oleic and palmitic acids ($r = -0.73$). A positive relationship was observed between the percentage oleic and eicosenoic ($r = 0.38$), arachidic ($r = 0.28$) and lignoceric ($r = 0.12$) acids and significant inverse relationships between percentage oleic and behenic acids ($r = -0.48$). Oleic acid content was inversely related to iodine value ($r = -0.96$) and positively correlated to the ratio of unsaturated to saturated fatty acids ($r = 0.64$). The percentage of oleic acid showed a weak inverse association with oil content ($r = -0.13$). The strong negative correlation between the percentage of oleic and linoleic acid results from them being the main acyl groups in the oil, so that one cannot increase much without a

decrease in the other. The negative correlations between the percentages of oleic and linoleic and palmitic acids [19, 20] and no correlation, or weak inverse relationship between percentage oleic acid and oil content have also reported by other researchers [21]. These findings suggest that it is possible to obtain varieties with very high oleic and very low linoleic and palmitic acids with no significant loss in oil content of seed.

The mutant lines identified in this study were found to be promising from the viewpoint of oil quality and stability, and had an oil content comparable to the control. Now, they need to be tested for their productivity and adaptability. In currently grown cultivars, the O/L ratio ranges from 0.8 to 2.5 [22] and the accessions and germplasm screened in peanut have indicated low variability for fatty acid profile. In this regard, the mutants identified in the present study can be utilized as a potential genetic resource for improving peanut oil quality.

BIBLIOGRAPHY

- Cobb, W.Y., Johnson, B.R. Physicochemical properties of peanuts. *American Peanut Research Education Association*, 209-263 (1973).
- Fore, S.P. *et al.* Factors affecting the stability of crude oils of 16 varieties of peanuts. *J. Am. Oil Chem. Soc.* **30**, 298-301 (1953).
- Pickett, T.A., Holley, K.T. Susceptibility of types of peanuts to rancidity development. *J. Am. Oil Chem. Soc.* **28**, 478-479 (1951).
- Fore, S.P. *et al.* Factors affecting the stability of crude oils of 16 varieties of peanuts. *Journal of American Oil Chemistry Society*, **30**, 298-301 (1953).
- Anders, T.H. Effects of variety and maturity on lipid class composition of peanut oil. *Journal American Oil Chemistry Society* **57**, 8-11 (1980).
- Holley, K. T., Hammons, R.O. Strain and seasonal effects on peanut characteristics. University Georgia. *Coll. Agric. Exp. Stn. Res. Bull.* **32** (1960).
- Gorbet, D.W., Knauff, D.A. Registration of 'SunOleic 95R' peanut. *Crop Science* **37**, 1392 (1997).
- O'bryne, D.J. *et al.* Low fat-monounsaturated rich diets containing high-oleic peanuts improve serum lipoprotein profiles. *Lipids* **32**, 687-695 (1997).
- Renaud, S. *et al.* Cretan, Mediterranean diet for prevention of coronary heart disease. *American Journal Clinical Nutrition* **61**, 1360-1367 (1995).
- Knauff, D.A., Ozias-Akins, P. Recent methodologies for germplasm enhancement and breeding. *American Peanut Research and Education Society*, 54-94 (1995).
- Norden, A.J. *et al.* Variability in oil quality among peanut genotypes in Florida breeding programme. *Peanut Science* **14**, 7-11 (1987).

12. Knauff, D.A. *et al.* Further studies on the inheritance of fatty acid composition in peanut. *Peanut Science* **20**, 74-76 (1993).
13. Jambunathan, R. *et al.* Analysis of oil content of groundnuts by nuclear magnetic resonance spectrophotometry. *Journal Science Food Agriculture* **36**, 162-166 (1985).
14. Cocks, L. V., Rede, V. C. In: *Laboratory Handbook for oil and fat analysis*. Academic Press New York, (1966).
15. Archana, P. *et al.* Improvement of oil quality in soybean (*Glycine max* L.) by mutation breeding. *J. Am. Oil. Chem. Soc.* **84**, 1117-1124 (2007).
16. Chang, N.W., Huang, P.C. Effects of the ratio of polyunsaturated and monounsaturated fatty acids on rat plasma and liver lipid concentration. *Lipids* **33**, 481-487 (1998).
17. Graef, G. L. *et al.* Inheritance of fatty acid composition in a soybean mutant with low linolenic acid. *Crop Science* **28**, 55-58 (1988).
18. Downey, R. K., Taylor, D. C. Diversification of canola/rapeseed fatty acid supply for the year 2000. *OCL* **3**, 9-13 (1996).
19. Anderson, P. C. *et al.* Fatty acid and amino acid profiles of selected peanut cultivars and breeding lines. *Journal Food Composition and Analysis* **11**, 100-111 (1998).
20. Sekhon, K.S. *et al.* Variability in fatty acid composition in peanut I. Bunch group. *Journal Science Food Agriculture* **23**, 919-924 (1972).
21. Emiroglu, S.H., Marquard, R. Productivity and quality properties of Turkish peanut selections in comparison to international varieties. *Fette Seifen Anstrichm* **86**, 103-107 (1984).
22. Lopez, Y. *et al.* Genetic factors influencing high oleic acid content in Spanish market- type peanut cultivars. *Crop Science* **41**, 51-56 (2001).

Protein Content in High-Protein Soybean Mutants in Thailand

C Yathaputanon^{1,*}, B Kumsueb², A Malipan³, S Srisombun⁴ & J Bunyarut¹

Abstract

Two studies have been initiated to enhance nutritional quality of seed protein content in soybean varieties using induced mutation techniques. Approximately 5,000 seeds of uniform size of each variety were irradiated with Gamma-rays at a dose of 200Gy at Kasetsart University. The Kjeldahl method was used to analyze seed protein percentages. **Experiment I.** Seed of three soybean varieties, Chiang Mai 60, SSRSN35-19-4 and EHP275 were irradiated. M_1 to M_4 generations were grown at Nakhon Ratchasima Field Crops Research Center during 2004–2007. The Pedigree method of selection was used. In the M_2 , M_3 and M_4 generation, selected mutant lines had 1.9–2.6%, 1.5–2.3% and 0.8–2.2% higher seed protein content than the three checks, respectively. In a preliminary trial, the high protein mutant lines were tested for their protein yield. The mutants had average protein content of 42.5%, 42.4% and 42.9% whereas the check varieties had average protein content of 41.8, 40.3% and 41.9%, respectively. There were six, 18 and eight promising mutant lines selected from Chiang Mai 60, SSRSN35-19-4 and EHP 275, respectively. The mutant lines produced both high seed protein content and high yield. They will be tested in replicated trials in the research centers and farmer fields. **Experiment II.** cm9238-54-1 (ST) was a promising soybean line to be released for farmers. It gave 5–10% higher grain yield than cv Chiang Mai 60, the most popular variety in the northern and central regions. However, this line was susceptible to Soybean Crinkle Leaf (SCL) Disease. M_1 plants generated by induced mutation were grown in the dry season of 2003 at Sukhothai Technical and Production Resources Service Center (TPRSC). The M_2 and M_3 seed were sown in the dry and rainy seasons of 2004 and selected M_4 lines were tested for grain yield in four environments, dry and rainy season 2005, rainy season 2006 and dry season 2007 at Lop Buri TPRSC. From the 2006 to 2007 trials, six selected lines were found to be resistant to SCL in laboratory tests and gave 74–81% higher grain yield than that of the original parent. In addition, they had 2.1–4.0% and 2.1–7.5% higher seed protein content than a check variety, Chiang Mai 60, respectively and had 0.5–2.0% and -1.0–3.3% higher seed protein content than another check variety, SJ4, respectively. The mutants had average protein content of 38.5–43.8%, while the two check varieties had average protein content of 36.3–39.9%.

Introduction

Seeds of soybean (*Glycine max* L.) are important to the agriculture economy because of their high quality and nutritional protein. In Thailand, soybean has been cultivated following the rainy season rice harvest, particularly in the northern region for centuries. However, annual soybean production over the last five years has been able to supply only 15–20% of the country's demand. A total number of 16 varieties have

been officially released in Thailand since 1965, with the most popular varieties being Chiang Mai 60 and SJ4. These two varieties had average grain protein contents lower than 40%. An increase in seed yield and quality of soybean was achieved by pre-planting gamma irradiation [2]. Soybean variety improvement for increased nutritional quality protein content using induced mutation was initiated. It is possible to select mutant lines with seed protein content higher than their respective parents by at least 1–2%. The objective of the two studies presented here, which were undertaken in the IAEA/RAS/5/040 project, was to enhance protein content in soybean lines using induced mutation techniques.

Experiment I

Materials and Methods

Approximately 5,000 seeds of uniform size of each three soybean varieties, Chiang Mai 60, SSRSN35-19-4 and EHP275, were irradiated with Gamma-rays at a dose of 200Gy, as recommended by IAEA [3], at Kasetsart University. M_1 to M_4 generations were grown in the field at Nakhon Ratchasima Field Crops Research Center (FCRC) from 2004 to 2007. The Pedigree method of selection was used. The high protein mutant lines were tested for their protein yield in replicated trials. The Kjeldahl method [1] was used to determine seed protein percentages. Measurement of total nitrogen by Kjeldahl analysis is the historical reference method for determination of the protein content of dairy products. For quality assurance of the data, duplicated samples, laboratory-fortified matrix samples, and an internal reference, soybean seed sample were also analyzed and included in each batch of samples. The protein content was calculated as the total nitrogen (N) content multiplied by 6.25.

Table 1. The seed protein content in the M_2 , M_3 and M_4 generations and in a preliminary trial at Nakhon Ratchasima Field Crops Research Center from 2004 to 2007.

Varieties	Seed protein (%)			
	M_2	M_3	M_4	Preliminary trial
Mutant CM 60	45.16	43.87	42.77	42.52
Original CM 60	43.01	42.36	41.99	41.75
Difference CM 60	+2.15	+1.51	+0.78	+ 0.77
Mutant SSRSN 35-19-4	44.90	45.19	44.39	42.36
Original SSRSN 35-19-4	42.30	42.85	41.71	40.32
Difference SSRSN35-19-4	+2.60	+2.34	+2.02	+2.04
Mutant EHP 275	44.79	43.33	43.14	42.94
Original EHP 275	42.89	41.49	41.25	41.93
Difference EHP 275	+1.90	+1.84	+2.23	+1.01

CM 60 = Chiang Mai 60, Differences = Mutant minus Original

Results

No selection was made in the M_1 generation. The M_2 seed was bulked and M_2 plants with good agronomic traits were selected by comparison

¹ Nuclear Research in Agriculture Group, APSRDO, Department of Agriculture, Bangkok, Thailand

² Nakhon Ratchasima FCRC, Department of Agriculture, Nakhon Ratchasima, Thailand

³ Lop Buri TPRSC, Department of Agriculture, Lop Buri, Thailand

⁴ OARDRI, Department of Agriculture, Chiang Mai, Thailand

* Corresponding author. E-mail: chitima@doa.go.th

with the original parents. The average seed protein content of the M_2 generation, mutant lines of Chiang Mai 60, SSRSN 35-19-4 and EHP 275 were 45.2%, 44.9% and 44.8%, while the original parents were 43.0%, 42.3% and 42.9%, respectively. M_3 plants were grown in rows. In each row, the best four plants were selected for protein analysis. Average protein content of mutant lines were 43.9%, 45.2% and 43.3%, while the three check varieties had average protein content of 42.4, 42.8 and 41.5%, respectively. In the M_4 generation, the mutant varieties had 0.78–2.23% higher seed protein content than the three checks. In a preliminary trial, the high protein mutant lines were tested for their protein yield. The mutants had average protein content of 42.5%, 42.4% and 42.9%. The check varieties had an average protein content of 41.8%, 40.3% and 41.9%, respectively (Table 1). The promising mutants selected from Chiang Mai 60, SSRSN35-19-4 and EHP 275 had six, 18 and eight lines. The mutant lines produced both high seed protein content and high yield. They will be further tested in replicated trials in research centers and farmers' fields.

Experiment II

Materials and Methods

CM9238-54-1 (ST) is a promising soybean line to be released to farmers. It gave 5–10% higher grain yield than Chiang Mai 60, the most popular variety in the northern and central regions. However, this line is susceptible to Soybean Crinkle Leaf (SCL) Disease. Approximately 5,000 seeds of the line with uniform size were irradiated with a dose of 200Gy Gamma-rays, as recommended by IAEA [3], at Kasetsart University. The M_1 plants were grown in the dry season of 2003 at Sukhothai Technical and Production Resources Service Center (TPRSC). The M_2 and M_3 seed were sown in dry and rainy seasons of 2004, and the selected M_4 lines were tested for grain yield in four environments: dry and rainy season of 2005, rainy season of 2006 and dry season of 2007 at Lop Buri TPRSC. The six mutants from the rainy season of 2006 and dry season of 2007 trials were tested for their protein contents. The Kjeldahl method [1] was used to determine seed protein percentages. For quality assurance of the data, duplicated samples, laboratory-fortified matrix samples, and an internal reference, soybean seed samples were also analyzed and included in each batch of samples. The protein content was calculated as the total nitrogen (N) content multiplied by 6.25.

Results

In the rainy season of 2006 and dry season of 2007 trials, the six selected lines were resistant to SCL in laboratory tests and yielded 74–81% more grain than the original parent. In addition, the six mutants had 2.1–4.0% and 2.1–7.5% higher seed protein content than a check variety, Chiang Mai 60, respectively, and had 0.5–2.0% and -1.0–3.3% higher seed protein content than another check variety, SJ4, respectively. The six mutants had average protein content of 38.5–43.8% while the two check varieties had average protein content of 36.3–39.9% (Table 2). The six mutant lines will be tested in the farmers' fields.

Discussion

It is possible to select mutant lines with greater yields and seed protein contents one to two percent higher than their parents. Soy protein is an important source of high-quality, cholesterol-free, inexpensive protein. It is suited to human physiological needs and has great potential as a major source of dietary protein for the future. The policy of the Thai government is to increase grain protein percentage for day food products. In the international marketplace, buyers pay six to 15 cents per bushel more for soybeans with just 1% higher protein content. The results of two studies presented here, suggest that soybean variety improvement for increased nutritional quality protein content is possible using induced mutation techniques.

Table 2. The seed protein content of mutant varieties, rainy season of 2006 and dry season of 2007 at Lop Buri Technical and Production Resources Service Center.

Varieties	Seed protein (%)					
	Rainy 2006			Dry 2007		
	Protein (%)	Dif.CM 60	Dif.SJ 4	Protein (%)	Dif.CM 60	Dif.SJ 4
POP1-4-Mutant	40.78	+4.07	+1.99	42.86	+6.51	+2.88
POP16-42-Mutant	40.15	+3.44	+1.36	43.29	+6.94	+3.31
POP18-46-Mutant	40.23	+3.52	+1.44	38.45	+2.10	-1.53
POP19-49-Mutant	39.89	+3.18	+1.10	38.62	+2.27	-1.36
POP20-50-Mutant	40.70	+3.99	+1.91	43.84	+7.49	+3.86
POP30-1-Mutant	39.26	+2.55	+0.47	39.04	+2.69	-0.94
CM9238-54-1(ST)-Original	38.79	+2.08	0	39.04	+2.69	-0.94
SJ4-Check	38.79	+2.08	0	39.98	+3.63	0
Chiang Mai 60-Check	36.71	0	-2.08	36.35	0	-3.63

CM 60 = Chiang Mai 60, Dif. = Differences of Mutant minus Check

BIBLIOGRAPHY

1. Association Of Official Analytical Chemists (A.O.A.C.). Official Methods of Analysis, Eleventh Edition, Benjamin Franklin Station Washington, D.C., p.1015 (1970).
2. El-Bagoury, O.F., Mohammed, F.A., Ashoub, M.A., Hashim, M.F., And Magharby, G.M. Seed Yield and Seed Quality of Soybean as Influenced by Pre-Planting Gamma Irradiation and Spraying Plants with GA3. *Proceedings of World Soybean Research Conference VI*. August 4–7, Chicago, Illinois, USA, p.585 (1999).
3. International Atomic EnerGy Agency. *Manual on Mutation Breeding*, 2nd edition, Vienna, Austria, cited by Lamseejan, S., 1993. Plant Mutation. Faculty of Science, Kasetsart University, Bangkok. p.197 (1977).

Genetic Enhancement of Speciality Rice through Induced Mutation – Short-Grain Aromatic Rice

A Patnaik* & G J N Rao

Abstract

India has a rich diversity of widely distributed aromatic rices. They include Basmati, whose cultivation is limited to a well-demarcated geographic zone, and the short grain aromatic rices that are grown in localized pockets throughout India, which with their unique sensory and cooking traits, cater to defined groups of consumers in specific niche markets. Some short-grain aromatic rices like Dubraj, Durgabhog, Makarkanda, Badshahbhog are superior to Basmati in traits like high kernel elongation, high volume expansion and high head rice recovery, while Bindli is superior to Basmati in aroma and grain elongation. Kalajeera is known for the retention of aroma even after long storage. To date, little attention has been paid to short-grain aromatic rice, as the focus was directed towards improvement of Basmati. Less attention to the short-grain aromatic rices can be attributed to their low productivity, long duration and tall plant stature. As high economic returns are feasible with high-yielding varieties with shorter duration and shorter height, a mutagenesis approach was attempted to induce erect, semi dwarf, non-lodging mutants with high yield potential, while keeping the unique grain type and cooking quality traits of the parent cultivar. Twelve popular cultivars from different states (Kalanamak, Dubraj, Tulsiphoool, Randhunipagal, Badshahbhog, Katrani, Improved Raskadam, Kalajeera, Pimpudibasa, Chinikamini, Dhusara and Kalajoha) were subjected to gamma (γ) irradiation. From the M_2 generation, selection was initiated to isolate mutants with shorter duration and plant height. Mutants with shorter (~20%) stature derived from Kalanamak, Dubraj, Kalajeera and Chinikamini showed high promise in the evaluation trials. Mutants with shortened duration (~10d) were also isolated in all the four genotypes. With the isolation of mutants with desirable traits, an expansion in the area under short grain aromatic rices is feasible, and the expected rice surplus can augment farmers' income, as well as Indian exports.

Introduction

Indian aromatic rice germplasm is well known because of Basmati, a national heritage, which occupies most of the area under aromatic rice. This is complemented by a large number of aromatic short and medium grain land races, grown in specific pockets in different states of the country [1]. These specialty rices are endowed with quality characteristics that are not present in ordinary rices [2]. These rices are equal to, or superior to Basmati, having strong aroma and greater kernel elongation [3], the only difference being breadth wise swelling and shorter kernel length. These aromatic rices of the Indian subcontinent are classified in Group V along with Basmati [4]. Most of these land races are photosensitive, tall, late maturing, low yielders, and distributed in localized small pockets throughout the country. Most research efforts have concentrated on the improvement of Basmati rices as they are linked with valuable foreign exchange, and native short grain aromatic rices could not attract

the desired attention [5]. With the country gaining self-sufficiency in rice and transforming itself from a net importer to the second largest exporter of rice in the world, vast scope exists for these high value speciality rices that are famous for their cooking and eating qualities. Though Basmati's share is intact in the market, with the improving economic standards of the people, enough opportunities are available for commercial exploitation of these rices. Keeping this in mind, efforts are being made to improve the native land races through alterations in a few characters, such as duration and plant height, while retaining the unique quality features of each variety. A few aromatic short-grain varieties have been released in different states, including Ambemohar mutant in Maharashtra [6]. As it is a necessary to keep grain quality traits intact, it is difficult to get recombinants with the desired traits through pedigree breeding, but an induced mutation approach is ideal.

Materials and Methods

Seeds from 12 popular cultivars (Kalanamak, Dubraj, Tulsiphoool, Randhunipagal, Badshahbhog, Katrani, Improved Raskadam, Kalajeera, Pimpudibasa, Chinikamini, Dhusara and Kalajoha) were treated with three doses (200, 250 and 300Gy of ^{60}Co γ -rays at Utkal University, Bhubaneswar, in 2004. The irradiated seeds were sown in trays and transplanted to field with 10x10cm spacing. The fertilizer input was minimal to discourage tillering. The percentage survival was recorded in the M_1 generation and panicle-to-row progenies were grown in subsequent generations. The frequency of chlorophyll mutants in the M_2 generation was recorded as a ratio of panicles segregating chlorophyll mutations to the total number of panicles sown. Since all the cultivars were photoperiod sensitive, advancement of generations was undertaken only during the wet season, and starting from M_2 , the main criteria for selection was erect, non-lodging plant habit and earliness, while efforts were made to keep the parental grain characters intact. Promising mutants were evaluated in both M_3 and M_4 generations in observational trials conducted at the CRRRI experimental farm.

Results and Discussion

The irradiated seeds of 12 cultivars were raised in trays and later transplanted in the field at very close spacing and the first three panicles from each individual M_1 plant were collected [7]. The materials were checked for treatment effects by observing seedling height using the growing rack method [8] that can effectively distinguish the effects of radiation-like delayed germination, stunted growth, poor vegetative vigor etc. (Fig. 1).

The results of four genotypes, Chinikamini, Dubraj, Kalajeera and Kalanamak, are presented in Table 1. A minimum of 200 plants (two treatments, 250 and 300Gy, of 200 seeds each) were raised in the M_1 generation, and more than 600 lines (400 M_1 plants x 3 panicles each) for each treatment were grown in the M_2 generation. The frequency of chlorophyll-deficient mutations were scored (Table 2).

The data shows that genotypic differences exist in the biological damage caused by the radiation treatment. The chlorophyll-based mutation frequency was highest (23.8%) in Dubraj while the lowest (~8%)

Division of Crop Improvement, Central Rice Research Institute, Cuttack-753006, India

* Corresponding author. E-mail: ashok19512002@yahoo.co.in

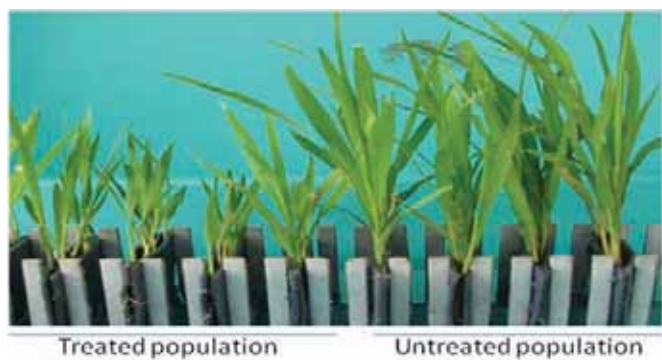

Figure 1 Screening of mutagen treated populations (M_1 generation) through seedling rack method.

damage was seen with Kalajeera. However, the chlorophyll mutation frequency was found to have no relation to the other traits under study, as the frequency of lines with the desired alterations, i.e. short duration and shorter height, were higher in Kalajeera than in Dubraj and Kalanamak.

These four short-grain aromatic rices have excellent grain and cooking quality characteristics (Table 3), and while making selections, it was ensured that these quality traits remained intact.

In the M_3 generation, selections were made exclusively on the shorter plant height and the results are presented in Table 4. The yields were calculated on a single plant basis.

Table 4. The range of the different characters observed in mutants with reduced plant height in different genotypes in the M_3 generation.

Parent and mutants	Plant height (cm)	Panicle length (cm)
Chinikamini		
Putative Mutants (66)	129-157	28.5
Parent	161	24
Dubraj		
Putative Mutants (25)	100-146.6	20.9-26.6
Parent	157.5	23.8
Kalajeera		
Putative Mutants (98)	141-151	28.2-32.6
Parent	176.5	32.5
Kalanamak		
Putative Mutants (22)	122-135	22.5-24.2
Parent	176.5	32.5

The yield did not appear to increase, although mutants with significant reduction in height were isolated in each genotype. Mutants with semi-dwarf stature (~100cm) were observed only in Dubraj, with a reduction of more than 50cm in height, while in Kalajeera the reduction in plant height was only 30cm, with mutants in the other two cultivars having intermediate heights (Fig. 2).

Table 1. Number of plants grown from treated populations and mutants isolated in different generations

Genotype	M_1^*	M_2^{**}	M_3	M_4
Kalajeera	400	1169	98	15
Kalanamak	400	1173	22	9
Chinikamini	400	1130	66	19
Dubraj	400	1118	25	18

* @ 200 plants for each treatment

** @ Progeny from around 600 first formed panicles from each of three M_1 plant

Table 2. Frequency of chlorophyll deficient mutants in different genotypes.

S. no	Cultivar	No of M_1 plants grown	No M_2 lines segregating for chlorophyll mutations	(%)
250Gy				
1.	Kalajeera	530	43	8.11
2.	Chinikamini	528	69	13.06
3.	Dubraj	541	81	14.97
4.	Kalanamak (37632)	534	87	16.29
300Gy				
1.	Kalajeera	569	48	8.43
2.	Chinikamini	545	109	20.00
3.	Dubraj	589	140	23.76
4.	Kalanamak (37632)	584	115	19.69



Figure 2 Mutants with reduced plant height induced in different short grain aromatic rice cultivars (the highest plant in each photo is the parent control)

In the M_4 generation, some of the mutant lines showed high levels of uniformity. Observations were made, except for yield potential of the mutant lines, and selections were made for short duration and plant yield, while trying to keep the grain quality intact (Table 5). Eighteen

Table 3. The physico-chemical properties of grain quality of aromatic rices

Genotype	MILL (%)	HRR (%)	KL (mm)	KB (mm)	L/B Ratio	GrnTy	Grain chalk	VER	WU (ml)	KLAC (mm)	ER	ASV	AC (%)	GC mm
Chinikamini	69.4	67.2	3.43	2.17	1.58	SB	VOC	5.3	175	6.8	1.98	5.0	23.30	53
Dubraj	70.2	56.7	5.83	1.94	3.0	MS	voc	4.9	130	10	1.71	7.0	25.86	48
Kalajeera	67.5	60.7	3.95	2.12	1.86	SB	VOC	5.3	187	8.0	2.01	4.7	22.68	63
Kalanamak	64.9	51.8	5.46	1.92	2.84	MS	voc	5.3	195	9.9	1.81	5.0	25.52	53

Source: Directorate of Rice Research Annual Progress Report, Vol 1(2003-2005). Mill: milled rice; HRR: head rice recovery; KL: kernel length; KB: kernel breadth; Grn Ty: grain type; VER: volume expansion ratio; WU: water uptake; KLAC: kernel length after cooking; ER: elongation ratio; ASV: alkali spreading value; AC: amylose content; GC: gel consistency

desirable selections of Dubraj were advanced to the M_4 generation, but the crop was severely affected by rice tungro disease, which led to stunted growth of several mutant lines, and as a result, no observations were recorded and the generation will be grown again.

Table 5. The range of the different characters observed in mutants with reduced plant height in different genotypes in the M_4 generation.

Parent and mutants	DFF	Plant height (cm)	Panicle length (cm)	Harvest index	Yield (kg/ha)
Chinikamini					
Mutants (19)	110-120	122-156.4	20.3-23.9	0.19-0.42	1044-2698
Parent	120	168	22.6	0.31	2642
Kalajeera					
Mutants (15)	115-123	141-146	28.2-33	0.10-0.18	
Parent	121	176	30.6	0.11	
Kalanamak					
Mutants(9)	110-130	122-150	22.5-24.2	1380-2152	
Parent	131	176	32.5	2560	

DFF: Days from sowing to 50% flowering.

Discussion

The data clearly indicates that mutants with shorter duration could be induced in four genetic backgrounds, while reductions in plant height varied from genotype to genotype. Plant height varied from 122cm to 156cm in the mutant lines, and for duration, a 10-day reduction was seen. However, with the reduction in plant height, yield levels also declined and efforts are now underway to grow more plants from each genotype. Selections will be based on duration, plant height and yield.

As expressed in several quarters, there is increasing demand to develop a market for these short-grain aromatic rices. Mutants with shorter plant stature with a high response to fertilizer are needed to exploit the enormous diversity of aromatic rice germplasm [9]. These rices could constitute a third distinct category of rices, after Basmati and non-aromatic rices for export purposes.

BIBLIOGRAPHY

1. Richharia, R.H., Govindaswami, S. *Rice of India*, p.346 (1966).
2. Chaudhary, R.C., Tran, D.V. Speciality rice of the world: a prologue. In: *Speciality Rices of the World –Breeding, production and marketing*, Eds. Chaudhury, R.C., Tran, D.V. and Duffy, p.3-12 FAO. Rome. Published by Oxford&IBH (2001).
3. Singh, R.K. *et al.* Current status and future prospects of improving traditional Aromatic rice varieties in India. In: *Speciality Rices of the World –Breeding, production and marketing*, Eds. Chaudhury, R.C., Tran, D.V. And Duffy, R., p.79-87FAO, Rome. Published by. Oxford & IBH (2001).
4. Glaszmann, J.C. Isozymes and classification of Asian rice varieties. *Theoretical and Applied genetics* **74**, 21-30 (1987).
5. Shobha Rani, N. *et.al.* Research efforts towards development of Basmati and quality rices. In: *National Symposim On Export of Quality Rice*, New Delhi. p.31-59 (2004).
6. Aromatic Rices Of India, Technical Bulletin, Directorate of Rice Research. Hyderabad, India (2004).
7. Patnaik, A., Vasudevan, K., Sarma, N.P. Induced mutation frequencies in different tiller categories in rice. *Cereal Research Communication* **8**(3), 575-576 (1980).
8. Myhill R.R., Konzak, C.F. A new technique for culturing and measuring barley seedlings. *Crop Science* **7**, 275-277 (1967).
9. Vats, U.K., Singh, P. Promoting Trade In Aromatic Rices. *India Grains*: May 2002. p.11-14 (2002).

Development of a High Oleic Soybean Mutant and its Stability Across the Environments

A Patil*, S P Taware & V S Rao

Abstract

Modifying seed oil composition has become a major goal in soybean breeding programmes. Elevated oleic acid and reduced linoleic and linolenic acid content can improve the oxidative stability, flavor and nutritional value of soybean oil. The objectives of this study were (1) to develop a high oleic acid soybean mutant and (2) to determine the stability of its fatty acid composition across different environments. A high oleic acid mutant (HOM), containing 40% of oleic acid compared to 27% in parent cultivar MACS 450, was selected from a treatment with 200Gy γ -rays and 0.15% ethyl methane sulphonate (EMS). To investigate the influence of environmental factors on fatty acid composition, the HOM, along with four other soybean lines (MACS 1034, MACS 1055, MACS 1092 and Bragg) was grown at 12 locations. Seeds of each genotype from each location were analyzed for fatty acid composition by gas chromatography. Eberhart and Russell's linear regression model was used to study the environmental stability of fatty acid composition. In general, all the fatty acids studied were influenced by environmental factors. Elevated oleic acid in the HOM was less stable across environments than the oleic acid content in the other four cultivars. The mean oleic acid content in the HOM was 31.26 - 45.18% over the 12 locations. Linoleic acid content in the HOM and in MACS 1034 also showed significant deviation from unity for their regression coefficient, indicating significant environmental effects. This study shows that extent of the elevation of oleic acid and reduction of linoleic acid content in the HOM are strongly influenced by environmental factors.

Introduction

The end use of soybean oil is influenced by its fatty acid composition. Common soybean cultivars consist of 11% palmitic, 4% stearic, 24% oleic, 54% linoleic and 7% linolenic acid. Changing the proportion of these fatty acids will enhance food, fuel and other applications of the oil. The high content of polyunsaturated fatty acids (i.e. linoleic and linolenic) limits the utility of soybean as cooking oil, unless it is hydrogenated. Genetic modification of soybean oil composition to reduce polyunsaturated fatty acids and increase monounsaturated (oleic) fatty acids could be a viable strategy to improve oil stability and flavor without the need for hydrogenation, which produces undesirable trans fat causing increased cholesterol and heart disease in humans [1]. Also oil with a high content of monounsaturated fatty acids is less susceptible to oxidative changes. Mutation breeding is one of the best and widely used tools to alter the fatty acid composition in most of the oilseed crops [2-6].

Environmental influences on the fatty acid profile of soybean oil from common cultivars have been observed in several studies. The effects of year or location on the fatty acid content of soybean lines with different fatty acid profiles have been investigated in many reports [7, 8]. The differences in fatty acid content are likely to be a consequence of

the different weather patterns, from year to year and location to location. Seed development at higher temperatures resulted in a significant decrease in linoleic and linolenic acid and increase in oleic acid content [9-11]. Palmitic and stearic acids are generally unaffected by changes in temperature. Evaluation of stability of oleic, linoleic and linolenic acid contents of genotypes with modified fatty acid profiles is necessary to determine their utility in plant breeding programmes, developing soybean cultivars with enhanced oil quality and adaptation to a wide range of environments. This study had the objectives of developing a high oleic acid soybean mutant and determining the stability of its fatty acid composition across different environments.

Materials and Methods

A high oleic acid soybean mutant (HOM), cultivar Bragg, and three soybean breeding lines (MACS 1034, MACS 1055, MACS 1092) were used in this study.

Mutation treatment

Seeds of soybean cultivar MACS 450 were treated with doses of γ -radiation and various concentrations of ethyl methane sulfonate (EMS). The mutation treatments given to seeds of MACS 450 are described by Patil, *et al.* [12]. The seeds of each treatment were sown in two rows. Each row consisted of 100 seeds with a distance of 5cm within rows and 45cm between rows. At the M_1 generation, 92 morphological variants were identified in the field and advanced until the M_4 generation by single seed descent. A line containing 40% oleic acid (as compared to 27% in MACS 450), derived from a treatment of 200Gy γ -radiation and 0.15% EMS, was selected from the M_4 population. Stability of the high oleic acid mutant (HOM) was tested until the M_8 generation at the research farm of the Agharkar Research Institute (Hol, Pune, India).

G X E interaction

To study the influence of the environment on fatty acid composition, the HOM, four soybean lines and cultivar Bragg were grown at 12 locations in the rainy season of 2006. Locations, latitude, planting dates and soil types are listed in **Table 1**. The trial was conducted in a randomized complete block design, with three replications at each location. Each row was three meters long. Distance between the rows was 45cm. Planting was done by hand with a seeding rate of 100 seeds per row.

Fatty acid analysis

An approximately 20g seed from each sample was ground in a mill. Out of this, approximately 200mg of powder was taken for fatty acid extraction. The fatty acid extraction was carried out according to the method of Primomo, *et al.* [13]. Fatty acid analysis was carried out on a gas chromatograph (6890 N series, Agilent Technologies Inc., Wilmington, DE, USA) using a HP-Innowax capillary column (J&W Scientific, Agilent Technologies Inc., Wilmington, DE, USA). The temperatures of injector, oven and detector were adjusted to 225°C, 150°C and 275°C, respectively. The initial oven temperature of 150°C was ramped by 15°C/min up to

Genetics Group, Plant Sciences Division, Agharkar Research Institute, G. G. Agarkar Road, Pune-411004, Maharashtra, India

* Corresponding author. E-mail: archie_2180@yahoo.co.in

250°C. The air, hydrogen and nitrogen (carrier gas) flow rates were set to 400 mL/min, 30 mL/min and 2 mL/min, respectively. Methyl esters of palmitic, stearic, oleic, linoleic and linolenic acids (Sigma Chemical Co., St. Louis, MO, USA), were used as standards to calibrate the method. The signals from the detector were integrated as normalized percentages from the calibration curve by using the HP CHEMSTATION software (Agilent Technologies Inc., Wilmington, DE, USA).

Table 1. Latitude, soil type, planting dates for each of twelve locations, 2006

Sr No	Location	Soil Type	Planting dates	Latitude (°N)
1	Amlaha	Black	6 July 2006	23.12
2	Amravati	Medium Black	7 July 2006	21.-89
3	Bangalore	Red Sandy Loam	27 July 2006	12.58
4	Dharwad	Black	26 June 2006	15.26
5	Jabalpur	Clay	2 July 2006	23.90
6	Jalna	Black	26 June 2006	19.52
7	Nagpur	Clay	3 July 2006	21.09
8	Pachora	Medium Black	30 June 2006	20.83
9	Pantnagar	Sandy Loam	26 June 2006	29.00
10	Pune	Clay Loam	22 July 2006	18.04
11	Ranchi	Red Latteritic	27 June 2006	23.17
12	Sangli	Clay	11 July 2006	16.08

Statistical Analysis

Analysis of variance (ANOVA) for each location and a combined ANOVA across the test environments was performed for all fatty acids. To characterize the genotypic stability for fatty acid composition, Eberhart and Russell's (1966) linear regression model was used. For each genotype, stability was described by three parameters viz., mean performance (X), regression from the mean performance on environmental index (bi) and the function of squared deviation from regression (S^2_{di}). Combined ANOVA and stability analysis was performed using Agrobase/4TM (Agronomix Software Inc., Manitoba, Canada).

Results and Discussion

Development of the high oleic acid soybean mutant (HOM)

As result of mutagenic treatments, 92 morphological variants, including heterophylly, late maturing, early maturing, high-yielding and white-flowered were observed in the M_2 generation in the field. Each was harvested individually and advanced by single seed descent to the M_3 generation. Fatty acid analysis of seed from these mutants showed a wide range of variation for oleic acid content (23-40%). A high oleic acid mutant (HOM) from a mutagenic dose of 200Gy γ -radiation and 0.15% EMS was selected. Its seed contained 40% oleic acid whereas the

Table 2. Pooled ANOVA

Source	D.F.	Mean Squares				
		Palmitic acid	Stearic acid	Oleic acid	Linoleic acid	Linolenic acid
Genotype	04	3.29 ^{ab}	0.25 ^{ab}	511.98 ^{ab}	565.65 ^{ab}	0.61
Environment + (Genotype x Environment)	55	0.39 ^a	0.08	10.55 ^{ab}	6.37 ^{ab}	0.60 ^a
Environment (linear)	01	8.90	1.31	301.2	350.2	15.4
Genotype x Environment (linear)	04	0.41 ^{ab}	0.05 ^{ab}	7.85 ^{ab}	4.71 ^{ab}	0.15 ^{ab}
Pooled deviation	50	0.22 ^{ab}	0.05 ^{ab}	4.96 ^{ab}	2.51 ^{ab}	0.33 ^{ab}
Pooled error	120	0.02	0.001	0.03	0.035	0.01

^{a, ab} Significant at probabilities of 0.05, 0.01, respectively

Table 3. Mean seed oleic acid content (%) over 12 locations^c

Variety	1	2	3	4	5	6	7	8	9	10	11	12	Mean
MACS1034	20.6	20.0	21.9	21.4	27.2	23.5	27.5	21.4	23.6	21.2	19.2	25.4	22.8
HOM	34.2	34.7	31.3	35.7	44.0	32.9	40.6	40.4	40.4	39.4	34.7	45.2	37.9
MACS1055	21.8	18.6	27.8	21.3	24.4	23.4	25.0	19.8	24.3	22.9	19.6	22.2	22.6
MACS1092	24.3	23.8	25.6	24.5	29.8	24.5	22.2	25.3	24.8	23.6	21.8	32.2	25.2
BRAGG	18.2	18.4	24.2	23.5	20.5	22.6	27.4	24.9	24.6	22.7	21.6	28.0	23.0
Mean	23.8	23.1	26.2	25.3	29.2	25.4	28.5	26.4	27.5	26.0	23.4	30.6	
Ij	-2.5	-3.2	-0.1	-1.0	2.9	-0.9	2.3	0.1	1.3	-0.3	-2.9	4.3	
SE+	0.22	0.04	0.08	0.15	0.06	0.08	0.11	0.12	0.35	0.34	0.04	0.06	
LSD (P=0.05)	0.73	0.13	0.26	0.16	0.21	0.25	0.37	0.38	1.14	1.11	0.15	0.18	
LSD (P=0.01)	1.06	0.19	0.38	0.23	0.30	0.36	0.54	0.55	1.66	1.61	0.21	0.26	

^c Columns entitled 1-12 in Table 3, 4 and 5 are the 3 locations described in Table 1.

Table 4. Mean seed linoleic acid content (%) over 12 locations^c

Variety	1	2	3	4	5	6	7	8	9	10	11	12	Mean
MACS1034	57.3	55.4	54.7	55.8	52.5	54.6	52.2	55.8	54.4	56.7	57.3	52.8	55.0
HOM	43.6	42.1	43.0	39.8	34.8	43.0	38.9	37.0	37.9	37.7	41.4	33.0	39.4
MACS1055	57.2	58.3	50.6	55.7	53.6	55.4	53.7	57.5	53.8	55.1	57.4	55.8	55.4
MACS1092	54.9	54.1	51.9	53.0	49.7	54.4	54.7	53.0	53.4	54.1	55.2	47.1	53.0
BRAGG	60.3	56.4	54.1	53.3	54.7	55.7	52.3	53.6	54.9	57.1	56.7	50.4	55.0
Mean	54.7	53.3	50.9	51.5	49.1	52.6	50.4	51.4	50.9	52.1	53.6	47.8	
Ij	3.2	1.8	-0.6	0.003	-2.5	1.1	-1.1	-0.1	-0.7	0.6	2.1	-3.7	
SE+	0.14	0.03	0.06	0.13	0.06	0.16	0.08	0.10	0.49	0.36	0.14	0.05	
LSD (P=0.05)	0.44	0.11	0.20	0.41	0.21	0.52	0.26	0.33	1.59	1.18	0.46	0.15	
LSD (P=0.01)	0.64	0.16	0.30	0.60	0.30	0.76	0.38	0.48	2.31	1.72	0.66	0.22	

^c Columns entitled 1-12 are the 3 locations described in Table 1.

Table 5. Mean seed linolenic acid content (%) over 12 locations^c

Variety	1	2	3	4	5	6	7	8	9	10	11	12	Mean
MACS1034	7.9	8.1	8.7	8.7	7.0	7.4	6.9	7.6	7.4	7.7	8.6	8.3	7.9
HOM	6.7	7.5	8.7	8.5	7.0	7.8	6.4	6.9	7.0	7.4	8.2	7.3	7.5
MACS1055	7.2	8.1	7.1	8.7	7.1	6.8	6.9	7.9	7.1	7.7	8.4	8.2	7.6
MACS1092	6.8	7.0	7.9	8.0	6.5	6.5	8.2	6.8	6.6	7.6	8.3	6.9	7.3
BRAGG	7.5	9.0	7.7	8.8	9.3	8.0	6.3	7.0	6.6	6.0	8.0	7.9	7.7
Mean	7.2	8.0	8.0	8.6	7.4	7.3	6.9	7.2	7.0	7.3	8.3	7.7	
Ij	-0.3	0.4	0.4	1.0	-0.2	-0.3	-0.6	-0.4	-0.6	-0.3	0.7	0.2	
SE+	0.08	0.02	0.03	0.06	0.06	0.02	0.03	0.07	0.22	0.20	0.03	0.05	
LSD (P=0.05)	0.27	0.08	0.10	0.19	0.19	0.07	0.11	0.21	0.70	0.64	0.10	0.17	
LSD (P=0.01)	0.39	0.12	0.16	0.28	0.27	0.10	0.15	0.31	1.02	0.93	0.14	0.25	

^c Columns entitled 1-12 are the 3 locations described in Table 1.

Table 6. Stability parameters for all fatty acids

Sr no	Variety	Palmitic acid			Stearic acid			Oleic acid			Linoleic acid			Linolenic acid		
		X	bi	S ² _{di}	X	bi	S ² _{di}	X	bi	S ² _{di}	X	bi	S ² _{di}	X	bi	S ² _{di}
1	MACS 1034	11.5	1.7	0.1 ^a	3.0	0.8	0.03 ^a	22.8	1.0	1.91 ^a	55.0	0.8 ^a	1.0 ^a	7.9	1.1 ^a	0.1 ^a
2	HOM	12.6	1.2	0.6 ^a	2.8	0.5	0.02 ^a	37.8	1.6 ^a	7.31 ^a	39.4	1.5 ^a	4.1 ^a	7.5	1.1 ^a	0.2 ^a
3	MACS 1055	11.3	0.4	0.1 ^a	3.1	1.1	0.01 ^v	22.6	0.6	5.55 ^a	55.4	0.6	3.8 ^a	7.6	0.9	0.2 ^a
4	MACS 1092	11.8	0.8	0.02 ^a	2.8	0.9	0.07 ^a	25.2	0.9	4.79 ^a	53.0	1.1	1.7 ^a	7.3	0.7	0.4 ^a
5	BRAGG	11.3	0.9	0.3 ^a	3.1	1.7	0.14 ^a	23.0	0.9	5.08 ^a	55.0	1.1 ^a	1.9 ^a	7.7	1.2	0.8 ^a

^{a, ab} Significant at probabilities of 0.05, 0.01, respectively

control MACS 450 had 27% oleic acid. The HOM was advanced and multiplied until the M_6 generation. The stability of the high oleic acid trait was tested at each generation at Hol Farm, Pune. It showed 34% to 67% oleic acid content in different generations. At the M_7 generation, in a replicated evaluation trial, analysis of variance showed a highly significant increase in oleic and decrease in linoleic acid content ($P = 0.01$; data not shown), whereas other fatty acids showed no significant change. Two high oleic mutants obtained by X-ray irradiation, M_{23} (46.1%) and M_{11} (35.9%), have been reported previously [15, 16]. The elevated oleic and reduced linoleic acid content in the HOM might be due to the mutation in seed specific, *fad2-1* gene or genes [17], which code for a microsomal omega 6 desaturase enzyme. Also, HOM oil can have more oxidative stability as compared to MACS 450, as the rate of oxidation of linolenic, linoleic and oleic acid is in the ratio of 21.6:10.3:1.

G X E interaction

Combined analysis of variance showed significant differences among genotypes for all fatty acids except for linolenic acid (**Table 2**).

Environment + (Genotype x Environment) effects were significant for the content of all fatty acids, except for stearic acid, and the Genotype x Environment (linear) effect was significant for all fatty acids, showing a strong influence of the environment on these traits. Studies conducted in controlled environments have shown that temperature [10] and precipitation [11] have a major impact on fatty acid levels in soybean seeds. Therefore, temperature and precipitation could be the underlying factors that contributed to the location effects observed in this study. Significant differences for unsaturated fatty acids i.e. oleic, linoleic and linolenic acid were observed among genotypes at all locations. Unsaturated fatty acid content (oleic, linoleic and linolenic acid), environment index (Ij), standard error and LSD (at $P=0.05$ and 0.01) for each genotype over all 12 locations are given in **Tables 3, 4 and 5**.

Seeds of HOM had 31.26 - 45.18% oleic acid with an average of 37.8%, and 32.97 - 43.61% linoleic acid with an average of 39.35% across the 12 environments. By contrast, a narrow range for content of these fatty acids was observed in other cultivars containing normal oleic acid (**Tables 3, 4**). This indicated a strong influence of environment on the content of these fatty acids in HOM.

Stability parameters studied by Eberhart and Russell's model for each fatty acid are listed in **Table 6**.

Mean square deviations from linear regression (S^2_{di}) were significantly different from zero for all traits under study for all genotypes, indicating significant responses to changes in environments. However, significant deviation from unity for regression of the mean performance on environmental index (bi) was observed only for unsaturated fatty acids in a few genotypes. Only elevated oleic acid in HOM showed highly significant ($P = 0.01$) difference in bi, indicating above average stability of the mutated trait across the 12 environments. Similarly, highly significant deviation from unity for bi was observed in MACS 1034, HOM and BRAGG for linoleic acid. For linolenic acid, significant ($P = 0.05$) deviation in bi was observed in only MACS 1034 and HOM. The significantly high bi (greater than one) for oleic, linoleic and linolenic acids observed in HOM indicates its above average stability for these traits, and thus the influence of environmental factors on unsaturated fatty acids. In the case of HOM, an increase in oleic acid content was observed in warmer locations and a decrease in oleic acid content was observed in cooler locations, suggesting an effect of temperature on the oleic acid content of HOM. This is in agreement with earlier reports [13, 18].

BIBLIOGRAPHY

1. Wilson, R.F. Seed composition. P 621-677, In: H. R. Boerma and J. E. Specht (ed.) *Soybeans: Improvement, production, and uses*. 3rd ed. ASA, CSSA, and SSSA, Madison, WI (2004).
2. Hammond, E.G., Fehr, W.R. Registration of A5 germplasm line of soybean. *Crop Sci.* **23**, 192 (1983).
3. Auld, A.D. *et al.* Rapeseed mutant with reduced levels of polyunsaturated fatty acids and increased levels of oleic acid. *IBID* **32**, 657-662 (1992).
4. Ntiamoah, C. *et al.* Inheritance of elevated palmitic acid in flax and its relationship to low linolenic acid. *Crop Sci.* **35**, 148-152 (1995).
5. Fernandez-Martinez, J.M. *et al.* Sunflower mutant containing high levels palmitic acid in high oleic background. *Euphytica* **97**, 113-116 (1997).
6. Fehr, W.R., Hammond E.G. Reduced linolenic acid production in soybeans. U.S. Patent 5,850,030 (1998).
7. Cherry, J.H. *et al.* Differences in the fatty acid composition of soybean seed produced in northern and southern areas of the U. A. S. *Phytochemistry* **24**, 237-241 (1985).
8. Schnebly, S.R., Fehr, W.R. Effect of year and planting dates on fatty acid composition of soybean genotypes. *Crop Sci.* **33**, 716-719 (1993).
9. Howell, R.W., Collins, R.F. Factors affecting linolenic and linoleic acid content of soybean oil, *Agron. J.* **49**, 593-597 (1957).
10. Wolf, R.B. *et al.* Effect of temperature on soybean seed constituents: oil, protein, moisture, fatty acids, amino acids and sugars. *J. Am. Oil Chem. Soc.* **59**, 230-232 (1982).
11. Dornbos, D.L., Mullen, R.E. Soybean seed protein and oil contents and fatty acid composition adjustments by drought and temperature. *IBID* **69**, 228-231 (1992).
12. Patil Archana *et al.* Improvement of oil quality in soybean [*Glycine max* (L.) Merrill] by mutation breeding. *IBID* **84**, 1117-1124 (2007).
13. Primomo, V.S. *et al.* Inheritance and interaction of low palmitic and low linolenic soybean. *Crop Sci.* **42**, 31-36 (2002).
14. Eberhart, S.A., Russell, W.A. Stability parameters for comparing varieties, *IBID* **6**, 36-40 (1966).
15. Rahman, S.M. *et al.* High oleic acid mutant in soybean induced by x-ray irradiation. *Biosci. Biotech. Biochem.* **58**, 1070-1072 (1994).
16. Takagi, Y., Rahman, S.M. Variation of different fatty acids in mutants in comparison with natural soybean. *Bull. Fac. Agric., Saga Univ.* **79**, 23-27 (1995).
17. Heppard, E.P. *et al.* Developmental and growth temperature regulation of two different microsomal 6 desaturase genes in soybean. *Plant Physiology* **110**, 311- 319 (1996).
18. Oliva, M.L. *et al.* Stability of fatty acid profile in soybean genotypes with modified seed oil composition. *Crop Sci.* **46**, 2069-2075 (2006).

Study of Tomato Lines with High Nutritive Quality

N Tomlekova^{1*} & B Atanassova²

Abstract

This study was performed on tomato lines from the cultivated species carrying the mutant genes *hp* and *og^c*, as well as on lines originating from inter-specific hybridizations between *Solanum lycopersicum* Mill. and either *Solanum pimpinellifolium* Mill. or *Solanum chilense* Dunal, to evaluate their genetic potential to synthesize high lycopene. We evaluated the methodology of comparison, and the number of harvests necessary to determine whether individual plants or lines differed in their ability to accumulate high lycopene in their fruit. A relatively large variation between harvest dates was observed in the lycopene content in fruit of the lines and hybrids studied, but the genotypes investigated were ranked almost identically at all harvests. It was found that the genotypes possessing genetic potential to synthesize high lycopene content might be assessed based on the analysis of fruit from a single harvest. Studies to fingerprint and evaluate DNA variability among tomato lines from diverse origins or possessing genes enhancing lycopene content, as well as on some of their F₁ hybrids, were performed. The AFLP data indicated very low levels of genetic heterogeneity in the tomato lines studied. Selective markers with a direct application in the molecular selection of tomato lines and hybrids with economically valuable mutant characters were revealed. The origins of the studied tomato lines make them genetically heterogeneous. Grouping performed on the basis of AFLP patterns followed the species origin of the genotype in most of the cases.

Introduction

Tomatoes are one of the most important crops in the world because of the volume of their consumption and overall contribution to human nutrition [1, 2]. They are as well, the major source of lycopene, an important phytonutrient for human health. Few genes that result in enhanced carotenoid accumulation in tomato have been identified. The *high pigment (hp)* mutation results in increased accumulation of both lycopene and β -carotene during fruit development. Mutant plants are characterized by elevated levels of anthocyanins and dark-green immature fruit, due to the overproduction of chlorophyll pigments [3]. Recent studies have provided evidence that *hp-1* and *hp-2* are separate loci, *hp-1* located on chromosome 2 and *hp-2* located on chromosome 1 [3, 4]. The practical use of these genes is rather limited because of their undesirable pleiotropic effects that include slow seed germination, increased seedling mortality and premature defoliation [5]. The crimson/old gold (*og^c*) gene increases lycopene by about 50%, while reducing β -carotene by the same amount [6]. Germplasm with enriched lycopene content (as well as enriched content of other compounds or characteristics related to fruit nutrition and flavor quality) might be developed on the basis of interspecific hybridization [7, 8]. However, the development of such germplasm is a difficult process, as the lycopene content of tomatoes depends not only on genetic factors, but also on environmental factors,

such as a light intensity during ripening [9], temperature [10], growing season, location, irrigation, soil etc. [11, 12, 13, 14].

The present study was therefore designed to: 1) evaluate the methodology of comparison, as well as the number of harvests necessary to determine whether individual plants or lines possess the genetic potential to accumulate high lycopene content in their fruit, and 2) fingerprint and evaluate DNA variability among tomato lines from *Solanum lycopersicum* Mill. possessing economically important characters and differing in their lycopene content.

Materials and Methods

Plant Material

Studies were performed on the following genotypes: lines XXIV-13, St-993, C-19, B-317, VK-1 and G-32 [15, 16, 17]. In order to get a more reliable baseline for comparative evaluation of the variation in fruit lycopene content, Ailsa Craig (AC) and the near isogenic lines (NILs) differing in genes *hp* (*high pigment*) and *og^c* (*old gold -crimson*) described by [18] and their F₁ hybrids were included in the study.

Biochemical analyses

Ten fruit from each line or hybrid, of uniform size and color, were sampled at the same stage of maturity and used for biochemical analyses. Lycopene content was determined by chromatographic absorption [19] (mg %) and High Performance Liquid Chromatography (HPLC) (mg/100g dry matter). The analyses were executed in three replicates. The results are expressed as the means and standard errors calculated from replicates [20].

DNA extraction

Three or four unexpanded young leaflets were collected from individual plants. DNA was isolated using the PhytoPure Kit protocol (Amersham) using 0.033 g lyophilized leaves.

AFLP analysis

AFLPs were obtained according to the protocol of Kashkush, *et al.* [21] involving: (i) *Restriction* (using the enzymes *EcoRI*, *MseI*) *ligation* (of adapter pairs onto restriction sites ends), (ii) *Preselective amplification*, (iii) *End labeling* (with γ -ATP-P³² of *EcoRI*-based primers), (iv) *Selective amplification* (with selective primer pairs *EcoRI/MseI*: 1-ACT/CAT, 2-ACA/CAT, 3-AGG/CTT, 4-ACT/CAG, 5-ACC/CAC, 6-CAG/CAG, 7-CGT/CAT), (v) *Electrophoresis* (using PAAG) and (vi) *Scoring of markers*: Those bands showing clear polymorphism among genotypes were scored. A matrix was designed based on the total number of bands in all studied samples for each selective primer pair. Individuals with presence of a band were given a score of "1". The lack of a band was given a score of "0".

Statistical analysis

Relative frequencies were calculated by a standard method. For expressing the genetic distances among AFLP patterns a cluster analysis method

¹ Department of Plant Breeding, Maritza Vegetable Crops Research Institute, Plovdiv, Bulgaria

² Institute of Genetics 'Prof. D. Kostov', BAS, Sofia, Bulgaria

* Corresponding author. E-mail: tomleкови@mail.bg

using Euclidian distances was applied, especially linkage distances, using the statistical package Statistica Version 6.0.

Results and Discussion

Table 1 shows that there was large variation between harvest dates in the lycopene content of fruits from the lines and hybrids studied. In all genotypes, fruit lycopene content increased from July 25th to August 10th to August 25th. Fruit lycopene content evaluated on August 25th exceeded that on July 25th, on average by 25%. According to Helyes, *et al.* [9] rainfall, temperature and light intensity during the period preceding the harvest date exercise a considerable effect on lycopene content. It is possible that such environmental factors influenced the fruit lycopene content on different harvest dates.

The genotypes could be divided into three groups based on their lycopene content: 1) genotypes that always have the highest lycopene content (G 32, Ailsa Craig *hp* and Ailsa Craig *og*^c), 2) genotypes always having low lycopene content (VK 1, B 317, C 19), and 3) genotypes with lower lycopene content than those from group 1, but significantly higher lycopene content than those from group 2 (XXIV 13, St 993, Ailsa Craig, Ailsa Craig *og*^c x Ailsa Craig *hp*). This data suggests that genotypes with genetic potential to synthesize high lycopene content might be identified from analyses of fruit collected at one harvest date. However, comparisons of genotypes sampled on different harvest dates could be misleading. A second, and if possible, a third analysis on different harvest dates might be helpful in providing additional information on a genotype's capacity to synthesize lycopene, as well as its variation during the harvest season.

Table 1. Variation in fruit lycopene content of tomato genotypes sampled on three harvest dates.

Genotype	Absorption chromatographic method / Rank (R) (mg%)				HPLC / Rank (R) (mg/100g dry matter)			
	July 25 th	R	August 10 th	R	August 25 th	R	August 25 th	R
G 32 <i>hp og</i> ^c	8.6 ± 0.4	1	9.0 ± 0.3	1	10.9 ± 0.2	1	117.0 ± 0.2	2
A. Craig <i>hp</i>	6.7 ± 0.2	2	8.4 ± 0.3	2	8.9 ± 0.4	2	150.3 ± 0.4	1
A. Craig <i>og</i> ^c	5.8 ± 0.2	4	7.4 ± 0.1	3	7.7 ± 0.3	4	92.8 ± 0.3	3
XXIV-13	4.8 ± 0.1	7	7.2 ± 0.2	4	7.8 ± 0.3	3	80.9 ± 0.2	4
AC <i>og</i> ^c x AC <i>hp</i>	5.0 ± 0.3	6	6.9 ± 0.4	5	6.9 ± 0.1	6	75.4 ± 0.1	6
AC <i>hp</i> x AC <i>og</i> ^c	5.6 ± 0.2	5	6.5 ± 0.2	6	7.2 ± 0.1	5	77.5 ± 0.1	5
A. Craig	4.7 ± 0.1	8	6.4 ± 0.4	7	6.8 ± 0.2	6	69.1 ± 0.2	8
VK 1	4.3 ± 0.1	9	4.5 ± 0.1	9	4.3 ± 0.1	9	51.3 ± 0.2	10
B 317	4.6 ± 0.2	8	5.0 ± 0.4	8	5.2 ± 0.3	7	54.1 ± 0.3	9
St 993	5.9 ± 0.3	3	6.4 ± 0.1	7	6.9 ± 0.2	6	70.4 ± 0.2	7
C 19	3.9 ± 0.1	10	4.2 ± 0.4	10	4.8 ± 0.1	8	50.4 ± 0.3	11

Fingerprinting and evaluation of DNA variability among tomato lines differing in their lycopene content were performed and data was summarized in **Figure 1**. Nineteen polymorphic bands were identified among 425 bands scored: ACT/CAT picked out C 19 and B 317 from the others of the two groups by the absence of band 10th in both genotypes. Two more bands associated C 19 and B 317 with each other, and were distinct from the other genotypes, with ACT/CAT. The ACA/CAT produced three polymorphic bands and was able to distinguish XXIV-13 from the other genotypes. This profile specificity was associated with the absence of two bands presented in the other members of the group (16 and 31), and band 30 that was not presented in the other lines. Five polymorphic bands were obtained with the combination AGG/CTT in three of the analyzed genotypes: XXIV-13, St 993 and VK 1. The compared profiles were completely identical after amplification with ACT/CAG and the

genotypes were not distinguishable. Two polymorphic bands were found with ACC/CAC in three samples. They were different from the 10 others analyzed on the gels. C 19 could be distinguished from VK 1 and B 317 by one fragment. VK 1 and B 317 had identical DNA fingerprints. The four polymorphic bands obtained by ACC/CAC differentiated three from the others. Additionally, among the lines, one band separated B317 from VK1 and one band separated C 19 from B 317 and VK 1. A unique polymorphic band was found with CGT/CAT in VK 1 that was absent in the other samples. VK 1 and Ailsa Craig, considered as representatives of the cultivated species, showed comparatively more genetic divergence.

Ailsa Craig and St 993 composed one group according to the cluster analysis, and XXIV-13 was added to this cluster (**Fig. 2**). These three genotypes were classified in the same group based on their lycopene content (group 3). Both St 993 and XXIV-13 include in their pedigrees *S. pimpinellifolium* [13], which might explain their genetic similarity calculated on the basis of molecular markers. The other genotypes composed different clusters and their differences were significant. Both B 317 and C 19 were characterized by low lycopene content and both had *L. chilense* in their pedigrees [13, 15]. However, these genotypes were placed in separate clusters, close to each other. The finding that genotypes from group 2 and group 3 (based on their lycopene content) composed different clusters and is not useful for the identification of genotypes possessing high lycopene content, as this differentiation is due to species origin rather than to their lycopene content.

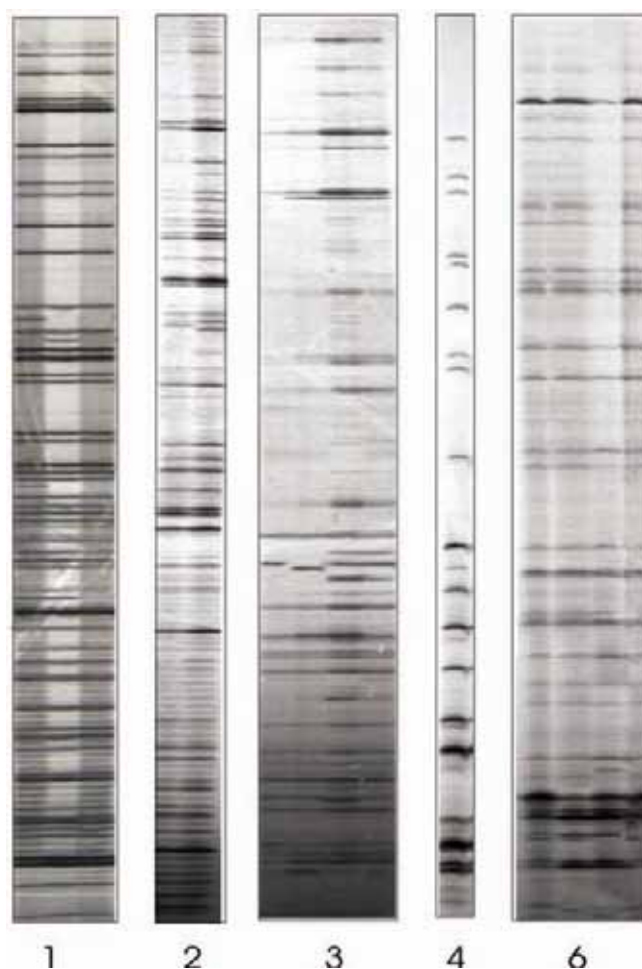

Figure 1 AFLP patterns of the genotypes: 1. ACT/CAT: 1.non polymorphic, 2.C19, 3.B317; 2. ACA/CAT: 1.XXIV-13, 2.non polymorphic lines; 3. AGG/CTT: 1.XXIV-13, 2.St993, 3.VK1, 4.non polymorphic; 4. ACT/CAG: non polymorphic; 5. ACC/CAC: not shown; 6. CGT/CAT: 3.VK1, 1., 2., 4.non polymorphic.

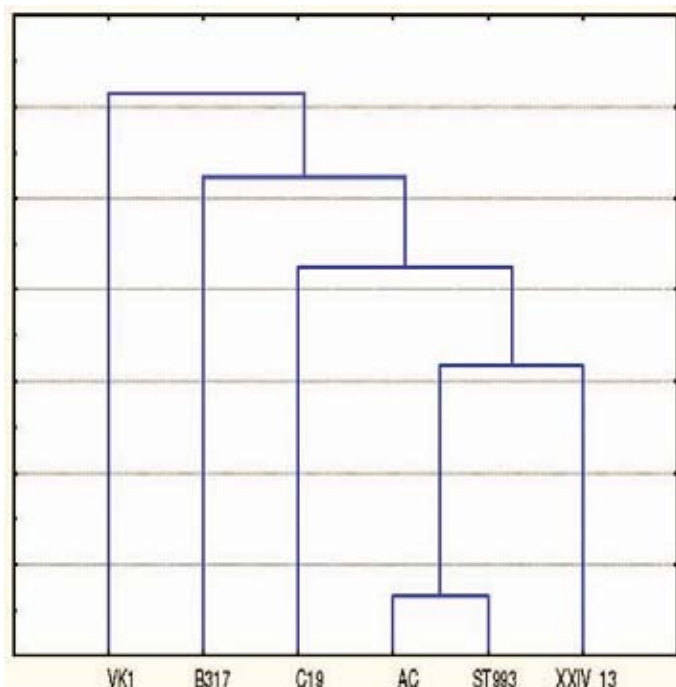

Figure 2 Clusters of AFLP patterns data from groups 2 and 3.

Conclusions

The ability of tomato lines to accumulate lycopene in their fruit was evaluated and this trait was found to be genotype-dependent. However, the accumulation of lycopene was observed to differ between harvests in all genotypes. Grouping performed on the basis of AFLP patterns followed the species origin of the genotype in most of the cases.

ACKNOWLEDGEMENTS

Work performed under Research Contract N°12227 with FAO/IAEA within the CRP D23024 on Physical Mapping Technologies for the Identification and Characterization of Mutated Genes Contributing to Crop Quality. Thanks to Prof. Uri Lavi from Volcani Center – Israel for introducing the AFLP method applied for this study.

BIBLIOGRAPHY

- Jankuloski, L.J., Stojkovski, C., Ivanovska, S., Tudzarov, T. Inheritance of some yield components in tomato (*Lycopersicon esculentum* Mill.), Symposium proceedings. First Symposium on Horticulture. Ohrid, Macedonia, 230-236 (2002).
- Jankuloski, L.J., Stojkovski, C., Ivanovska, S. Inheritance of dry matter content in F_1 and F_2 generation of tomato (*Lycopersicon esculentum* Mill.), XXXIX Croatian Symposium on Agriculture. Opatija, Croatia, 164-165 (2004).

- Yen, H.C., Shelton, B.A., Howard, L.R., Lee, S., Vrebalov, J., Giovannoni, J.J. The tomato high-pigment (*hp*) locus maps to chromosome 2 and influences plastome copy number and fruit quality. *Theor. Appl. Genet.* **95**, 1069-1079 (1997).
- Myers, J.C.M., Chetelat, R.T. Allele tests of high pigment genotypes using root anthocyanin expression. *Rep. Tomato Genet. Coop.* **51**, 23-26 (2001).
- Stommel, J.R. Genetic enhancement of tomato fruit nutritive value. In: Genetic improvement of Solanaceous. V. 2. Tomato. (Eds. M. Razdan and Mattoo A.), Sci. Publishers., USA, 193-238 (2007).
- Scott, J.W. University of Florida tomato breeding accomplishments and future directions. *Proc. Soil and Crops Society of Florida* **58**, 8-11 (1998).
- Daskaloff, C., Konstantinova, M., Molle, E., Baralieva, D. Genetic studies on tomato quality. *Bulg. Acad. Sci. Press.*, Sofia, Bulgaria (1990).
- Stommel, J.R. USDA 97L63, 97L66 and 97L97: Tomato breeding lines with high fruit beta carotene content. *HortSci.* **36**, 387-388 (2001).
- Helyes, L., Pek, Z., Brandt, S., Varga, G., Barna, E., Hovari, J., Lugasi, A. Influence of harvest date on fruit technological traits of five processing tomato varieties. *Acta Horticulturae* **604**, 213-216 (2003).
- Dumas, Y., Dado, M., Di Lucca, G., Grolier, P. Effect of environmental factors and agricultural techniques on antioxidant content of tomato. *J. of the Sci. of Food and Agriculture* **83**, 369-382 (2003).
- Hardevinder, S., Cheema, D.S. Studies on genetic variability and heritability for quality traits of tomato (*Lycopersicon esculentum* Mill.) under heat stress conditions. *Journal of Applied Horticulturae* **7**, 55-57 (2005).
- Garcia, E., Barrett, D.M. Assessing lycopene content in California processing tomatoes. *Journal of Food Processing and Preservation* **30**(1), 56-70 (2006).
- Lester, G.E. Environmental regulation of human health nutrients in fruit and vegetables. *Hort. Science.* **41**, 59-64 (2006).
- Tomlekova, N., Atanassova, B., Marinova, D., Baralieva, D., Ribarova, F. Study on the Variability of Lycopene and β -carotene Content in Tomato (*Lycopersicon esculentum* Mill.). *Acta Horticulturae* **729**, 101-104 (2007).
- Atanassova, B. Odysseus - tomato hybrid with extended shelf life. *Genetics and breeding* **28**, 35-38 (1996/97).
- Atanassova, B., Shtereva, L., Baralieva, D., Georgiev, H. Study of the content variation of compounds related to nutritive and flavor quality in tomato (*Lycopersicon esculentum* Mill.). *Acta Hort.* **613** 327-330 (2003).
- Atanassova, B. Study on genic male sterility and marker genes in tomato (*Lycopersicon esculentum* Mill.). Ph.D. Thesis. Sofia, BAS (2003).
- Maxon, S., Ritchie, J.W., Ritchie, D.B. A collection of near isogenic lines of tomato. Research tool of the future? *Plant Mol. Biol. Newsletter* **3**, 20-25 (1982).
- Manuelyan, H. Improved method of chromatographic separation of carotene in tomatoes. *Hort. Vitic. Sci.* **4**(2), 53-58 (1967) (in Bulgarian).
- Lakin, G.F. Biometrics, Vishaia Shcola, Moscow (1990) (in Russian).
- Kashkush, K., Fang, J., Tomar, E., Hillel, J., Lavi, U. Cultivar identification and genetic map of mango (*Mangifera indica*). *Euphytica* **122**, 129-136 (2001).

CONCURRENT SESSION 6

New Techniques and Systems for Mutation Induction

Restriction Endonucleases as a Tool for *In Vivo* Induction of Chromosomal and DNA Damage in Barley Genome

L Stoilov^{1,*} & K Gecheff²

Abstract

Bacterial restriction endonucleases have been widely utilized to study the significance of DNA double-strand breaks for the formation of chromosomal aberrations based on their ability to produce this particular DNA lesion. Such studies were very scarce in plants until mid-nineties. The stability of maize nuclei towards *in vivo* action of *EcoRI* was investigated, revealing that dry embryo cells were less resistant than meristematic ones actively involved in transcription. Restriction endonucleases were also found to induce structural chromosomal damage in barley genome. They exerted an S-independent mode of action revealing the transition between the G₁ and S phase as the most sensitive stage for aberration induction. Intra-chromosomal localization of chromatid aberrations produced by *HpaII*, *MspI* and *HaeIII* displayed similar distribution patterns. The most pronounced aberration hot-spots were the Nucleolus Organizing Regions which pointed towards the potential of restriction endonucleases for damage induction in specific genomic locations. Patterns of the localized chromosomal breakage produced by *HaeIII* in suitably reconstructed karyotypes showed substantial difference in the aberration hot-spot behavior. Position-specific increase in aberration clustering was found indicating that the incidence of aberration hot-spots generated by restriction endonucleases is dependent on their chromosomal environment. Barley karyotypes with normal and increased expression of rRNA genes were further utilized to evaluate the possible relationship between their transcriptional activity and damage induction. Hybridization profiles obtained after treatment with *MspI* revealed similar induction kinetics. The potential of barley ribosomal genes to accumulate double-strand breaks with a different structure was also tested by *AluI* and band intensity reduction followed the pattern found for *MspI*. Results indicated that the mode of action of restriction endonucleases applied was not substantially influenced by the activity of the nucleolus organizing regions. The data as a whole supports options for the use of restriction endonucleases for directed induction of damage in plant genome.

Introduction

The use of bacterial restriction endonucleases (RE) for induction of chromosomal damage in eukaryotes was the subject of extensive studies during the last two decades of the previous century. This interest was initiated by the need to study the role of DNA double-strand breaks (DSB) in the course of cellular responses to radiation-induced damage and from the necessity to reveal the molecular mechanisms governing the formation of chromosomal damage. The ability of RE to produce one particular DNA lesion, namely DSB, was widely utilized, but data for plants was practically unavailable until the mid-nineties.

Description of the research

Background studies

Radiation-generated DSBs were found to be the most likely primary lesion leading to the formation of chromosomal aberrations [1, 2]. This suggestion was strongly supported by the successful use of REs as effective inducers of chromosomal damage. The mode of action of REs was found to resemble those of ionizing radiation and radiomimetic chemicals in that it was S-phase independent: chromosome aberrations were induced in G₁ and chromatid in S and G₂ phases of the cell cycle. [3]. It was demonstrated that blunt-ended breaks tended to be more effective, leading to higher frequencies of chromosomal aberrations [4, 3]. Higher efficiency of REs recognizing four bases, and a lower efficiency for those recognizing six bases was also established. Aberration induction was found to also be dependent on a variety of other factors such as cell-cycle progression, cellular repair capacity, DNA methylation and the technique for introduction of REs within the cell nucleus [3, 5, 6].

It must be pointed out that the majority of the initial studies in the field were performed on mammalian cells, and until recently, the corresponding data from plants was very scarce. The first attempt to analyze the mode of action of RE on plant chromosomes was made by Subrahmanyam and co-authors in 1976 [7]. After treatment of barley root tips with a mixture of the restriction endonucleases *HindII* and *HindIII*, they found a time-dependent and progressive fragmentation of metaphase chromosomes, as well as a granular appearance of the interphase chromatin accompanied with micronuclei formation. These observations and the ample and decisive evidence of the chromosome-breaking ability of REs in mammalian cells urged us to utilize REs as a tool for induction of chromosomal and DNA damage in the barley genome.

Key findings

Differential response of maize nuclei upon treatment with restriction endonucleases in vivo

It was shown that higher-order chromatin structure in plants resembles that found in other eukaryotes, namely that the nuclear DNA is organized in a series of supercoiled loop domains anchored to a structure termed the nuclear matrix [8]. The germinating maize embryo represents a suitable model system for the study of the transition of an inactive genome of a dry embryo to the higher transcriptional activity of the germinating embryo cells. Electron microscopy studies have shown that the nuclei of dry embryo cells lack internal nuclear matrix, which is however, well-structured in the meristematic cells of the primary roots [9].

Stability towards the action of *EcoRI* of maize nuclei obtained from cells with different transcriptional activity (dry embryo, root tip meristem and epicotyl protoplasts) was investigated. After fluorescent staining of the resulting histone-depleted nuclei, it was found that dry embryo structures are less stable than those actively involved in transcription (Fig. 1), most probably due to the absence of a well-defined internal nuclear matrix, which points to the key role of this higher-order chromatin structure in the functioning of the plant genome [10].

¹ Department of Molecular Genetics, Institute of Genetics "Acad. D. Kostoff", Bulgarian Academy of Sciences, Sofia, Bulgaria

² Department of Cytogenetics, Institute of Genetics "Acad. D. Kostoff", Bulgarian Academy of Sciences, Sofia, Bulgaria

* Corresponding author. E-mail: molgen@bas.bg

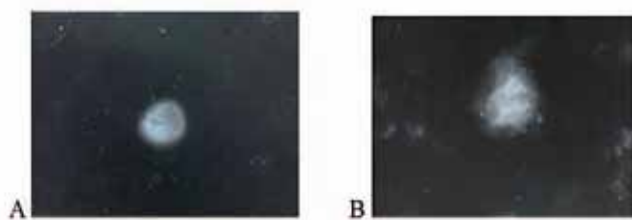

Figure 1 Fluorescent appearance of meristem (A) and dry embryo (B) nucleoids treated with *EcoRI*.

Restriction endonucleases induce chromosomal aberrations in barley
The clastogenic ability of *MspI*, *HpaII* and *HaeIII* in germinating barley seeds was evaluated by Feulgen staining of metaphase spreads. All REs were found to be efficient inducers of structural chromosomal alterations in barley, both of chromosome and chromatid type. The common feature of the induced chromatid aberrations was that isochromatid breaks and chromatid translocations were predominantly observed. Metaphases with multiple aberrations were also found at later recovery periods. The capacity for aberration formation was not significantly influenced by the nature of the DSB generated, but was found to be significantly dependent on the methylation status of the target DNA. Our data indicated that, like in other eukaryotes, REs display an S-independent mode of action. They revealed also that transition between the G₁ and S phases of the cell cycle is the most sensitive stage for induction of chromosomal damage by REs in the barley genome *in vivo* [11]. Examples of different types of chromosomal aberrations observed after RE treatment of barley root tips *in vivo* are presented in Fig. 2.



Figure 2 Chromosomal aberrations induced by REs in barley genome *in vivo*. [11]. i, isochromatid breaks; s, subchromatid exchange; t, chromatid translocation; tr, chromatid triradial; d, dicentric chromosome; b, chromatid break.

Intra-chromosomal mapping of chromatid aberrations induced by REs in barley

Chromosomal mutations have been widely used for reconstruction of the barley karyotype to improve its capacity in cytogenetic studies. A rich collection of reconstructed karyotypes in this species was created at our institute [12, 13]. These karyotypes were mainly used for investigation of regional specificity of mutagenic factors and chromosome position effects in the expression of induced aberration hot-spots.

Specific distribution of chromatid aberrations along individual chromosomes produced by *HpaII*, *MspI* and *HaeIII* in a multireconstructed barley karyotype PK 88, containing three reciprocal translocations, 1H-5H, 2H-7H, 3H-4H, and one pericentric inversion in chromosome 6H, was analyzed further. The REs were found to produce similar intra-chromosomal distribution patterns of the induced aberrations irrespective of their recognition sequence. In all cases, the most pronounced aberration hot-spots proved to be loci representative of both transcriptionally active and condensed (inactive) ribosomal DNA entities, localized within the chromosomal segments comprising the Nucleolus Organizing Regions (NORs). Such a biased aberration clustering (outlined in Table 1) demonstrates the ability of REs to induce damage in defined locations of the barley genome [14].

Table 1. Statistical evaluation of hot-spot chromosomal segment sensitivity after treatment with *HpaII*, *MspI* and *HaeIII*

Segment No	Total number of chromatid aberrations	
	Random distribution—Mean (range)	Observed value
<i>HpaII</i>		
4	5.4 (1.0-11.8)	12
11	5.4(1.0-11.8)	15
38	5.4(1.0-11.8)	20
46	5.4(1.0-11.8)	18
47	4.8 (1.4-11.0)	12
48	4.8(1.4-11.0)	25
<i>MspI</i>		
4	7.6 (0.0-15.2)	17
38	7.6 (0.0-15.2)	36
41	7.6 (0.0-15.2)	18
46	7.6 (0.0-15.2)	27
47	6.9 (0.4-14.2)	29
48	6.9 (0.4-14.2)	17
<i>HaeIII</i>		
38	8.4 (0.4-16.4)	37
41	8.4 (0.4-16.4)	19
46	8.4 (0.4-16.4)	32
47	7.6 (0.1-15.3)	31
48	7.6 (0.1-15.3)	26

Segment No	Theoretically expected random distribution	Total number of chromatid aberrations		Observed value
		Lower confidence limit	Upper confidence limit	
<i>HpaII</i>				
4	5.4	1.0	11.8	12
11	5.4	1.0	11.8	15
38	5.4	1.0	11.8	20
46	5.4	1.0	11.8	18
47	4.8	1.4	11.0	12
48	4.8	1.4	11.0	25
<i>MspI</i>				
4	7.6	0.02	15.24	17
38	7.6	0.02	15.24	36
41	7.6	0.02	15.24	18
46	7.6	0.02	15.24	27
47	6.9	0.37	14.20	29
48	6.9	0.37	14.20	17
<i>HaeIII</i>				
38	8.4	0.43	16.40	37
41	8.4	0.43	16.40	19
46	8.4	0.43	16.40	32
47	7.6	0.10	15.30	31
48	7.6	0.10	15.30	26

HaeIII induces position-dependent chromosomal breakage in barley
Patterns of the localized chromosomal breakage induced by restriction endonuclease *HaeIII* in reconstructed karyotypes T-1586 and T-21, showing respectively, standard and rearranged positions of NOR-bearing segments of chromosomes 6H and 5H, were further investigated. The structural details of these karyotypes are given in Fig. 3.

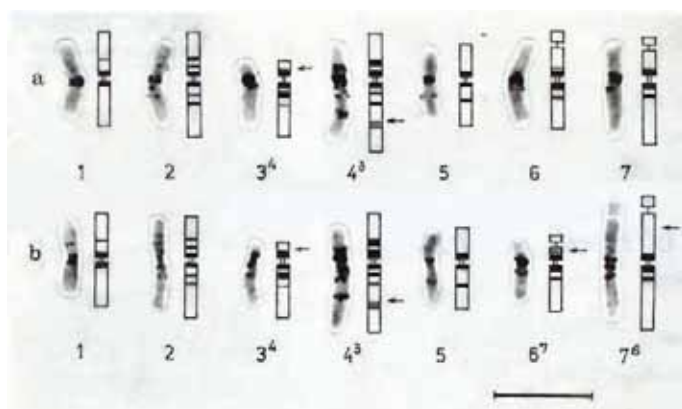

Figure 3 Idiograms of Giemsa-banded chromosomes of barley reconstructed karyotypes T-1586 (a) and T-21 (b). Chromosomes are indicated according to the old system, where chromosome 1 corresponds to 7H, 2=2H, 3=3H, 4=4H, 5=1H, 6=6H, and 7=5H [15]. Arrows indicate the putative translocation breakpoints.

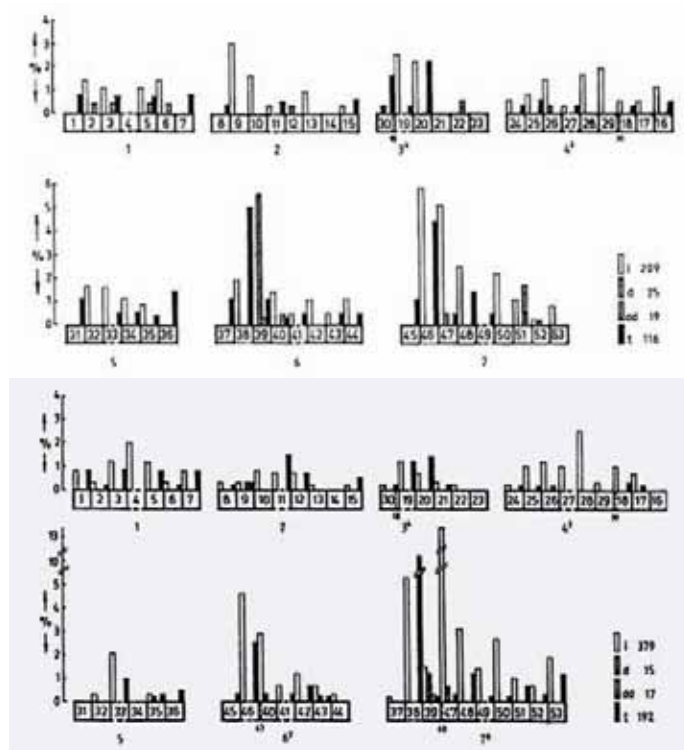

Figure 4 Intrachromosomal distribution of chromatid aberrations induced by HaeIII in karyotypes T-1586 (A) and T-21 (B). i- isolocus breaks; d- intercalary deletions; dd- duplication deletions; t- reciprocal chromatid translocations [17].

Due to the reciprocal translocation between the short arms of satellite chromosomes in T-21, the two most pronounced aberration hotspots (segments 39 and 47), after treatment with chemical mutagens [16] become arranged tandemly. In the control line T-1586, it was found that NORs of chromosomes 5H and 6H, respectively segments 46 and 38, containing actively transcribed ribosomal DNA, as well as segments 39 and 47, both representative of condensed rDNA repeats, are the most pronounced aberration hot-spots. Intra-chromosomal distribution of chromatid aberrations in T-21, where the NOR-bearing segments in chromosomes 6H and 5H change their position, revealed substantial difference in the aberration hot-spot behavior. Position-specific increase in aberration clustering was found, most obviously in segments 38 and 47. On the other hand, segment 46 retained its sensitivity, while segment

39 in its new location lost its previous status of aberration hot-spot. The data (Fig. 3) are indicative that the expressivity of aberration hot-spots generated by REs might be influenced by their distinct chromosomal location and/or chromatin organization [17].

Induction kinetics of RE-induced double-strand breaks in barley ribosomal DNA

There is a lot of data showing that certain types of DNA damage is more effectively removed from transcriptionally active genes than from silent regions, indicating the existence of intra-genomic repair heterogeneity [18]. It is now widely accepted that transcriptional activity and the higher-order chromatin structure are the main factors influencing the repair efficiency within a particular genetic loci or chromatin domains [19].

Based on our data, which unequivocally displayed that barley NORs behave as a prominent aberration hot-spots after treatment with RE *in vivo*, further studies on the ability of REs to produce DSB in barley ribosomal DNA were performed. Reconstructed barley karyotypes T-1586 and T-35 with normal and increased expression of rRNA genes, respectively, were utilized to evaluate the possible relationship between their transcriptional activity and DSB induction. Due to the enrichment of CCGG sites in barley ribosomal DNA, *MspI* was first utilized as a tool for induction of DSB. Scanning densitometry of the hybridization profiles obtained revealed similar induction kinetics for both karyotypes. The potential of barley ribosomal genes to accumulate DNA DSB with different structure and eventual dependence of the induction efficiency on DNA methylation was tested by treatment with *AluI*. Band intensity reduction followed the pattern already observed with *MspI*, displaying less amounts of full-length ribosomal repeats three hours after treatment. Histogram presentation of the data is presented in Fig. 5. No substantial difference between the two karyotypes was observed, which indicates that the mode of action of the REs applied was not substantially influenced by the activity of the corresponding NORs [20].

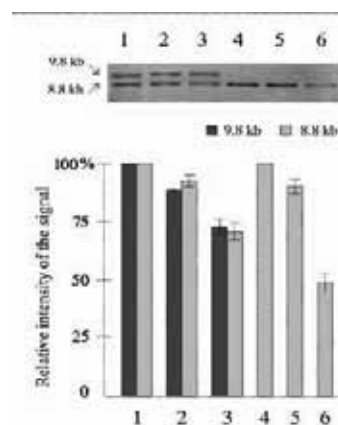

Figure 5 Induction kinetics of double-strand breaks induced by the restriction endonuclease *MspI* in barley ribosomal DNA. Lines 1, 2 and 3- karyotype T-1586. Lines 4, 5 and 6 - karyotype T-35 [20].

A question arises about the mechanisms maintaining rDNA integrity after DSB induction. Two major pathways are responsible for the recovery of DNA double-strand breaks in eukaryotic cells - homologous recombination (HR) and non-homologous end-joining (NHEJ) [21]. The existence of both repair pathways has been demonstrated in plants. It was shown that tobacco cells are able to repair site-specific DSBs artificially induced by REs via HR [22, 23]. As the search for homology in rDNA should be facilitated due to its repeated nature, it is tempting to speculate that recovery of ribosomal genes might be realized through HR. In plants, however, even in the cases when the finding of homology

is substantially simplified, the repair of DSBs might be also accomplished by NHEJ [24], which leaves the issue open.

Conclusions and likely outputs

The ability of REs to induce chromosomal and DNA damage in the barley genome *in vivo* is unequivocally established. The results concerning the mode of action on a chromosomal and gene-size scale point towards the potential of REs for inducing of DSB in defined genomic entities. Such data, along with the capacity of REs to facilitate genetic transformation, also points towards the options for site-directed induction of DNA breaks in a specific locations of the plant genome.

ACKNOWLEDGEMENTS

This work was supported by the National Science Fund of Bulgaria, Grant K-422 and the IAEA CRP Project Bul 5010.

BIBLIOGRAPHY

- Natarajan, A.T., Obe G., Van Zeeland A.A., Palitti F., Meijers M., Verdegaal-Immerzeel E.A.M. Molecular mechanisms involved in the production of chromosomal aberrations. II. Utilization of the neurospora endonuclease for the study of aberration production by X-rays in G₁ and G₂ stages of the cell cycle. *Mutat. Res.* **69**, 293-305 (1980).
- Obe, G., Natarajan A.T., Palitti F. Role of DNA double-strand breaks in the formation of radiation-induced chromosomal aberrations. In: Natarajan., A.T., Obe ,G. and Altmann, H. (eds), DNA Repair, Chromosome Alterations and Chromatin Structure. Elsevier Biomedical Press, Amsterdam, 1-9 (1982).
- Natarajan, A.T., Obe G. Molecular mechanisms involved in the production of chromosomal aberrations. III. Restriction endonucleases. *Chromosoma* **90**, 120-127 (1984).
- Bryant, P.E. Enzymatic restriction of in situ mammalian DNA using *PvuII* and *BamHI*: evidence for double-strand break origin of chromosomal aberrations. *Int. J. Radial. Biol.* **46**, 57-65 (1984).
- Bryant P.E., Birch, D.A., Jeggo, D.A. High chromosomal sensitivity of Chinese hamster *xrs 5* cells to restriction endonuclease-induced double-strand breaks. *Int. J. Radial. Biol.* **52**, 537-554 (1987).
- Morgan, W.F., Winegar, R.A. The use of restriction endonucleases to study the mechanisms of chromosome damage. In: Obe.G. and NatarajanAT. (eds), Chromosomal Aberrations: Basic and Applied Aspects. Springer, Berlin, 70-78 (1989).
- Subrahmanyam, N.C., Gould, A.R., Doy, C.H. Cleavage of plant chromosomes by restriction endonucleases. *Plant Science Letters* **6**, 203-208 (1976).
- Stoilov L., Zlatanova, J., Vasileva A., Ivanchenko, M., Krachmarov, Ch., Genchev, D. Supercoils in plant DNA. Nucleoid sedimentation studies. *Journal of Cell Science* **89**, 243-252 (1988).
- Krachmarov, Ch., Stoilov, L., Zlatanova, J. Nuclear matrices from transcriptionally active and inactive plant cells. *Plant Science* **76**, 35-41 (1991).
- Mirkova, V., Ivanchenko, M., Stoilov, L., Zlatanova, J. The stability of maize nuclei to restriction enzyme digestion differs with transcriptional activity. *Caryologia* **46**, 63-69 (1993).
- Stoilov, L., Mirkova, L., Dimitrova, A., Uzunova, V., Gecheff, K. Restriction endonucleases induce chromosomal aberrations in barley. *Mutagenesis* **11**, 119-123 (1996).
- Gecheff, K. Multiple reconstruction of barley karyotype resulting in complete cytological marking of the chromosome complement. *Theoretical and Applied Genetics* **78**, 683-688 (1989).
- Gecheff, K. Production and identification of new structural chromosome mutations in barley (*Hordeum vulgare* L.). *Theoretical and Applied Genetics* **92**, 777-781 (1996).
- Gecheff, K., Mirkova, V., Dimitrova, A., Georgiev, S., Stoilov, L. Intrachromosomal mapping of chromatid aberrations induced by restriction endonucleases in barley. *Theoretical and Applied Genetics* **94**, 919-924 (1997).
- Linde-Laursen, I., Heslop-Harrison, J.S., Shepherd, K.W., Taketa, S. The barley genome and its relationship with the wheat genomes. A survey with an internationally agreed recommendation for barley chromosome nomenclature. *Hereditas* **126**, 1-16 (1997).
- Gecheff, K. Further evidence for a high position-specific effect in the action of chemical mutagens on the chromosomes of barley. *Theoretical and Applied Genetics* **83**, 179-184 (1991).
- Stoilov, L., Mirkova, V., Gecheff, K. *HaeIII* induces position-dependent chromosomal breakage in barley (*Hordeum vulgare* L.). *Mutagenesis* **15**, 277-279 (2000).
- Mullenders, L.H.F. Transcription response and nucleotide excision repair. *Mutat. Res.* **409**, 59-64 (1998).
- Pfeifer, P., Gotlich, B., Reichenberger, S., Feldmann, E. Daza, P. J., Ward, F., Milligan, J.R., Mullenders, L.H.F., Natarajan, A.T. DNA lesions and repair. *Mutat. Res.* **366**, 69-80 (1996).
- Manova, V., Stoilov, L. Induction and recovery of double-strand breaks in barley ribosomal DNA. *DNA Repair (Amst.)* **2**, 983-990 (2003).
- Haber, J.A. Partners and pathways repairing a double-strand break. *TIG* **16**, 259-264 (2000).
- Puchta, H. Dujon, B., Hohn, B. Two different but related mechanisms are used in plants for the repair of genomic double-strand breaks by homologous recombination. *Proc. Natl. Acad. Sci. U.S.A.* **93**, 5055-5060 (1996).
- Gorbunova, V., Levi, A.A. Non-homologous DNA end joining in plant cells is associated with deletions and filler DNA insertions. *Nucleic Acids Res.* **25**, 4650-4657 (1997).
- BRITT, A.B. Molecular genetics of DNA repair in higher plants. *Trends in Plant Science* **4**, 20-25 (1999).

Achievements and Perspectives of Crop Space Breeding in China

L X Liu*, H J Guo, L S Zhao, J Wang, J Y Gu & S R Zhao

Abstract

Aerospace provides a special environment with strong cosmic radiation, microgravity, weak geomagnetic fields, and a super-clean super-vacuum. A large amount of experimental data showed that environmental conditions in space affect plant growth and development, as well as inducing genetic changes in crop seeds. The frequency of chromosomal aberrations is greatly increased in seeds carried into space and subsequently germinated on the ground. The combined effects of both cosmic radiation and microgravity, together with other spaceflight factors, appear to be the main causes of genetic changes in seeds from space flights. Since 1987, China has been conducting experiments of space-induced mutagenesis for crop improvement using recoverable satellites, Shenzhou spacecrafts and high-altitude balloons. *Shijian-8*, the first world satellite specially designed for the space-breeding programme, was launched on September 9, 2006. It carried over 2,000 plant accessions from 133 species. So far, 66 new mutant varieties of crops, including rice, wheat, cotton, rapeseed, sesame, pepper, tomato and alfalfa have been developed by the space-breeding programme and officially released in China. A catalog of useful rare mutant germplasm was also obtained. A new technique and method of mutation induction has been set up by simulating the space environment. It is concluded that space-induced mutation can be a novel and effective way to enhance genetic diversity from which to breed new crop varieties.

Introduction

Induced mutation in plants has been an effective breeding strategy in China for more than 50 years. According to incomplete statistics, by 2007 the total number of mutant varieties and mutant-derived varieties officially registered in China was 741, including 45 crops and ornamental species [1, 2]. The popularization and utilization of these mutant varieties has made an important contribution to China's food production and social and economic development. Mutation induction has become one of the most fruitful and widely used methods for crop improvement in China [3]. In the last 20 years, new mutagens, such as mutagenesis in space, have been explored and developed to actively upgrade mutagenic efficiency in crop breeding. This paper briefly reviews the recent advances and future perspectives of space-induced mutagenesis for crop improvement.

Space-induced mutation technique

The main characteristics of the aerospace environment are strong cosmic radiation, microgravity, weak geomagnetic fields, and a hyper-clean super-vacuum. A large amount of experimental research has shown that space environment affects seed germination and growth of plants [4, 5]. The mitotic index declines remarkably, and the type and frequency

of chromosomal aberrations in space-flown seeds are greatly increased compared to earth-bound controls. These mutagenic effects are universal among plants. Results from space flight experiments show that space conditions are mutagenic [6, 7].

The spaceflight-induced mutation technique, or "space breeding," is a technique that uses the genetic variations produced in plant seeds by the space environment that can be reached by recoverable spacecraft (such as recoverable satellites and space shuttles) and high altitude balloons to identify novel germplasm on the ground from which to develop new crop varieties [8].

Biological effects of space environment factors on plant seeds

The sensitivity to space flight differs between plant species and between varieties of the same species. After space flight and subsequent germination on the ground, seed vigor enhanced and germination rate increased markedly in seeds of wheat, triticale, barley, maize, cotton, sunflower, soybean, cucumber and tomato. There was no significant difference in germination rate compared to the ground control in seeds of rice, millet, pea, sweet pepper, lettuce and tobacco, while seed germination rate decreased in seeds of sorghum, watermelon, eggplant, radish and towel gourd [4, 5]. After space flight, seed germination potential, germination index, seedling height and seedling vigor index of wheat, barley and triticale were all significantly higher than those of ground controls and Gamma-ray irradiated seed. Activities of peroxidase isozymes and esterase isozymes also increased in these species by space flight. In contrast, germination and seedling growth of sorghum seeds was greatly reduced, and flowering was also delayed. The growth habit and maturation period of soybean were also affected by space flight [9].

Compared with traditional Gamma-ray irradiation and other mutagenic treatments, the greatest difference in agronomic performance of the first generation (SP_1) produced from seeds following space-flight was a lack of damage effects, such that space-flight could even produce a beneficial effect on the growth of SP_1 seedlings. In the SP_2 generation from dry seeds of *japonica* rice variety Zhongzuo 59 carried by a high altitude balloon, all 11 characters investigated, which included plant height, growth period duration, spike length, grain husk color and light sensitivity, differed widely. Some high-quality rice types were selected, which could be stabilized easily in later generations [10]. Although the variation in space-induced mutations in the SP_1 generation of wheat was lower than that of a Gamma-ray irradiation treatment, wide variation was observed in the SP_1 generation following space flight, with variation ranging from 2.2% to 11.1% [11].

Mutant varieties developed by space breeding

Since 1987, China has conducted experiments of space-induced mutagenesis for plant improvement 21 times using recoverable satellites, Shenzhou spacecrafts and high-altitude balloons to carry plant seeds into space. Seeds were planted after returning from space flight for the selection of useful mutations. *Shijian-8*, the breeding satellite specially designed for the space-breeding programme, was launched

Institute of Crop Science, Chinese Academy of Agricultural Sciences, The National Key Facility for Crop Gene Resources and Genetic Improvement, Beijing 100081, China

* Corresponding author. E-mail: luxiang@263.net.cn

on September 9, 2006. It carried over 2,000 accessions of plant seeds belonging to 133 species [2].

So far, China has officially approved 66 new varieties of crops including rice, wheat, cotton, rapeseed, sesame, pepper, tomato and alfalfa developed by the space-breeding programme. These new varieties have characters of high yield, good quality and multiple resistances. Some useful rare mutations that might make a great breakthrough in crop yield were also obtained [12, 13, 14]. The space breeding programme has begun to reap excellent social and economic benefits.

It has been shown that space-induced mutation breeding of crops can be a novel and effective way to create distinctive genetic resources with which to breed new varieties, due to its wide mutation spectrum, high frequency of useful genetic variation and short breeding period.

Mechanism of space mutagenesis

Some recent research on the effects of the space environment suggests that space flight is effective in inducing changes in crop genomes. The genomic polymorphisms in 201 rice plants developed from space flown seeds were investigated with RAPD analysis and 30.2% more polymorphisms were found compared with plants from ground control seeds [16].

The reasons why space environment causes chromosomal aberrations that result in alterations of genetic characters are not very clear at present. Space radiation is one possibility. More multiple chromosomal aberrations were observed in seeds hit by HZE (high-charge and high-energy) particles of cosmic radiation in space, and the frequency of abnormal plant development increased. The aberrations were different if HZE particles hit different parts of seeds. The frequency of aberration was the highest when the root meristem or hypocotyl was hit. However, many experimental results show that an increased frequency of aberrations can also be observed in seeds not hit by cosmic particles during space flight. The longer the seeds were kept in space, the higher the frequency of aberration, suggesting that microgravity might also have a mutagenic effect on seeds [6, 15].

It is evident that the combined effects of both cosmic radiation and microgravity are the main causes of the genetic changes in plants induced by space conditions. Once the seeds of plants that have evolved under the effects of earth gravity for billions of years were put in the microgravity environment of space and were affected by various physical radiation factors at the same time, their genomes were inevitably be strongly affected. In addition, the strong vibration and blast force associated with spacecraft launch and landing cannot be neglected as causal agents contributing to the increased frequency of chromosomal aberrations during space flight [5].

Study on simulating space environment factors

Because of the need for major investment and technological support, the chance of space flight experimentation is very limited. It is therefore, important to make ground simulations of space factors to investigate the mechanism of space-induced mutation and apply these to plant breeding.

Experiments were conducted to simulate factors of the space environment using accelerator or geomagnetic-field free space [9]. The mutagenic effects of various space-flight factors on wheat and other crops were studied from various angles of particle biology and physical field biology. It has been proven that the space environment has significantly different biological effects and mutagenic effects from traditional Gamma-rays. A new technique and method of mutation breeding by simulating the space environment has been set up.

Magnetic field-free space

Equipment of the magnetic field-free space (MF) is a large magnetic screening installation which uses a two-layer magnetic screening struc-

ture combined with coil compensation. Its magnetic strength is 20 nT, which is 4×10^{-4} of the magnetic strength of the earth's magnetic field.

Air-dried seeds of wheat, and of other plant species, were treated by MF at room temperature for various periods of time [17]. The results showed that the seed germination and seedling growth were obviously inhibited by over 180 days of MF treatment. The striking morphological features of the wheat seedlings treated by MF were that the first leaf of the seedling was shorter, wider and thicker, the leaf apex became round, and leaf color turned dark green. MF treatment during the process of anther callus induction of wheat, stimulated the development of male gametes and the final formation of calli, resulting in the production of high-quality anther calli and a high percentage of green plants. These significant differences from the traditional Gamma-ray treatment showed that MF had an obvious mutagenic effect on wheat seeds and could be used as a new physical mutagen for wheat improvement. Some new mutant varieties have been developed by MF treatment in rice and alfalfa [18, 19].

Single high-energy ion beam implantation

Air-dried seeds of wheat cultivars were irradiated using a single heavy ${}^7\text{Li}$ ion beam generated by a tandem accelerator at an energy level of 42.3 Mev. Studies of biological effects showed that ${}^7\text{Li}$ ion beam implantation inhibited germination rate, seedling height and root length in the M_1 generation. There was no linear dose-effect relationship, but the "Bragg peak" effect in ${}^7\text{Li}$ ion beam implantation. It was observed that 50Gy could be the appropriate dose of ${}^7\text{Li}$ ion beam to irradiate wheat seeds at an energy level of 42.3 Mev. Compared with Gamma-ray radiation, ${}^7\text{Li}$ ion beam implantation produced less biological damage. Various morphological and cytological aberrations of the seedlings occurred. The most significant variations were chlorophyll deficiency of the main vein, leaf split, leaf curl and tufted seedlings [20, 21, 22]. It was observed that ${}^7\text{Li}$ ion beam implantation into crop seeds can produce the effects not only of the energy transfer, mass deposition and charge exchange, as observed with other ion beams, but also the reaction of ${}^1\text{H}({}^7\text{Li}, {}^7\text{Be})n$ in the irradiated seeds.

Analysis of mutation types and frequencies of M_2 populations from seeds of wheat treated with ${}^7\text{Li}$ ion beams, demonstrated that this treatment could induce significant mutations. Mutation phenotypes of ${}^7\text{Li}$ heavy ion beams were mainly spike types and plant height. Due to the very limited M_2 population sizes from ${}^7\text{Li}$ heavy ion treatments, the statistics of frequency of mutations and mutants was incomplete. However, the data indicated that 50Gy of ${}^7\text{Li}$ heavy ion treatment could produce the highest mutation rate in both frequency and types, further suggesting that 50Gy could be the optimal irradiation dose for ${}^7\text{Li}$ heavy ion beam treatment in wheat [23, 24].

Mixed high-energy particles

Dry seeds of various genotypes of winter wheat and alfalfa were irradiated by a mixed high-energy particle field generated from E2 beam lines of LINAC of Beijing Electron Positron Collider [9, 25]. The cytological effects on the root tip cells of wheat seeds were studied, with the same dosage of Gamma-ray irradiation as a control. The results showed that irradiation with mixed high-energy particle field inhibited mitosis and produced various chromosomal aberrations such as micronucleus, chromosome bridges, circular chromosomes and dissociative chromosomes in root tip cells of wheat, with significant dose-effects. Higher rates of cytological damage and percentage of chromosome circles and fragments were found in the M_1 generation of wheat following mixed particle field irradiation than following Gamma-ray irradiation, indicating in the greater biological effects of irradiation with mixed high-energy particle fields than with Gamma-ray irradiation [26, 27]. A wider mutation spectrum and higher mutation frequencies, as well as a greater number of useful mutations for earlier maturity, shortness and spike type, were

observed in the M_2 generation following mixed particle field irradiation than following Gamma-ray treatment. The mixed particle field could be used as a new mutagen for mutation induction and crop improvement [16].

Conclusions and Prospects

Space-induced mutation is an effective new way not only to develop new crop varieties, but also to obtain rare mutants that may make great breakthroughs in important economic characters of crops, such as yield and quality, which are difficult to obtain using conventional breeding methods on the ground.

Research on the application of space-induced mutation techniques needs to be strengthened. It is necessary to undertake further work on several problems associated with space-induced mutation techniques, such as the selection of material, methods of treatment, molecular screening of mutants and the identification of quality characters in early mutant generations.

Because of the need for major investment and technological support, the chance of space flight experimentation is very limited. It is therefore, important to make ground simulations of space factors to conduct research for revealing the mechanism of space-induced mutation and apply this to crop breeding.

Recently developed biotechnological tools facilitating selection, characterization and genetic analysis of desired traits have significantly stimulated the use of space-induced mutation breeding and basic research. It is clear that the development of the space breeding programme will lean heavily on and be associated with, not only effective use of the approach, but also advances in plant biotechnology, particular plant molecular biology. Therefore, international cooperation will be very important for the sustainable progress of this research.

ACKNOWLEDGEMENTS

Acknowledgements: Research was successively supported by NSFC 39870192, 30270345 and 30670488, National Space Breeding Project (2003-138), National 863 Project (2002AA241011, 2007AA100102), National S & T Support Plan (2008BAD97B01), MOA Project (200803034), Core Research Budget of the Non-profit Governmental Research Institutions (ICS, CAAS) and the International Atomic Energy Agency, Vienna through Projects IAEA/RAS5045, RC12610, RC14195 and CPR5017.

BIBLIOGRAPHY

- Liu, L.X., Guo, H., Zhao, L., Zhao, S. Advances in induced mutations for crop improvement in China. In: *Proceeding of China-Korea Joint Symposium on Nuclear Technique Application in Agriculture and Life Science*. 22-25 April 2007, Hangzhou, China. 134-142 (2007a).
- Liu L.X., Guo H., Zhao L., Gu J., Zhao S. Achievements in the past twenty years and perspective outlook of crop space breeding in China. *Journal of Nuclear Agricultural Sciences*. **21**(6), 589-592 (2007c).
- Liu L.X., Van Zanten, L., Shu Q.Y., Maluszynski, M. Officially released mutant varieties in China. *Mutation Breeding Review*. **14**, 1-62 (2004b).
- Dutcher F.R., Hess E., Halstead T.W. Progress in plant research in space. *Adv Space Res*. **14**, 159-171 (1994).
- Liu L.X., Zheng Q. Space-induced mutations for crop improvement. *China Nucl. Sci. & Tech. Report*, CNIC01139/CSNAS-0111. China Nucl. Information Centre, Atomic Energy Press, Beijing, (1997).
- Halstead, T.W., Dutcher F.R. Plants in space. *Ann. Rev. Plant Physiol*. **38**, 317-345 (1987).
- Mei, M., Qin, Y. Sun, Y. Morphological and molecular changes of maize plants after seeds been flown on recoverable satellite. *Advances in Space Research*. **22**, 1691-1697 (1998).
- Liu L.X., Wang, J., Zheng, Q. Crop germplasm enhancement through aerospace mutation technique. In: *Proceedings of International Conference on Engineering and Technological Sciences* (Eds by Song Jian and Wang Maohua), New World Press, 356-357 (2000).
- Liu L.X., Wang, J., Zhao, L.S., Yang, J.C., Guo, H.J., Zhao, S.R., Zheng, Q.C. Research progress in mutational effects of aerospace on crop and ground simulation on aerospace environment factors. *Acta Agriculturae Nucleatae Sinica*, **18**(4), 247-251 (2004a).
- Chen, F., Jiang, X., Lu, S., Yi, X., Yang, C., Li, J. Effect on rice genetical character by high space condition. *Chinese Journal of Rice Science* **8**(1), 1-8 (1994).
- Liu, S., Li, X., Jin, L., Wang, W., Wun, G., Gao G., Dai, Q. The biological effects of the near-ground space treatment on M_1 of wheat varieties. *Acta Agriculturae Nucleatae Sinica* **10**(4), 205-210 (1996).
- Qiu, F., Li, J., Weng, M., Jin, D., Gao, H., Wang, P., Jiang, X., Wang, B. Molecular analysis of long-pod mutant line of mungbean generated by space mutagenesis. *Scientia Agricultura Sinica* **31**(6), 38-43 (1998).
- Shi, J., Fan, Q., Wang, L., Hu, P., Sun, G., Li, G. Induction of large grain mutation in azuki bean (*Phaseolus angularis* wight) by space environmental condition. **14**, 293-98 (2000).
- Liu, F., Cao, M., Rong, T., Pan, G. Screening a RAPD marker related to the maize male sterility gene obtained by space flight. *Journal of Sichuan Agricultural University*, **23** (1), 19-23 (2005A).
- Gu, R., Shen, H. Effects of space flight on the growth and some cytological characteristics of wheat seedlings. *Acta Photophysiological Sinica* **15**(4), 403-407 (1989).
- Luo, Y., Wang, X., Mei, M., Zhuang, C., Zhou, F., Wei, Z., Xie, H., Yao, J., Zhao, J. Genomic polymorphism in consecutive generation rice plants from seeds on board spaceship and their relationship with space HZE particles. *Acta Biophysica Sinica* **22**(2), 131-137 (2006).
- Liu, L.X., Zhao, L., Wang, J., Zheng, Q., Zhao, S. Biological effects of magnetic field-free space on wheat. *Acta Agriculturae Nucleatae Sinica* **16**(1), 2-7 (2002).
- Yu, Q., Liu, L.X., Huang, B., Xu, G., Zhang, Z-I. Selection of high quality male sterility line of indica rice by field-free magnetic space induction and its characters. *Acta Agriculturae Nucleatae Sinica* **20**(6), 497-499 (2006).
- Zhang, Y., Tang, F., Zhang, H., Han, W., Li, D., Liu, J., Hao, R., Shenk Z., Liu, L.X. Breeding of new variety nongjing no.1 of medicago sativa l. by magnetic field free space. *Journal of Nuclear Agricultural Sciences*. **21**(1), 34-37 (2006).
- Wang, J., Liu, L.X., Zhao, S.R., Yang, J.C., Guo, H.J., Zhao, L.S., Chen, W.H. Preliminary study on biological effects of ^7Li ion beams on *Echinacea purpurea*. *Acta Agriculturae Nucleatae Sinica* **17**, 405-408 (2003).
- Liu L.X., Guo, H.J., Zhao, L.S., Zhao, K., Zhao, S., Sui, L., Kong, F.Q. Bio-effects of ^7Li ion beams irradiation on wheat. *Annual report for Beijing National Tandem Accelerator Laboratory 2005*. Beijing Atomic Energy Press, Beijing, 104-105 (2007d).
- Xin, Q.G., Liu, L.X., Guo, H.J., Zhao, L.S., Yu, Y., Zhao, K., Sui, L., Kong, F.Q., Zhao, S. SSR analysis of M_1 variation of dry seeds implanted by ^7Li ion beam in wheat. *Journal of Triticeae Crops* **27**(4), 560-564 (2007).
- Guo H.J., Liu, L.X., Han W.B., Zhao, S.R., Zhao, L.S., Sui, L., Zhao, K., Kong, F.Q., Wang, J. Biological effects of high energy ^7Li ion beams implantation on wheat. *Plant Mutation Reports* **1**(3), 31-35 (2007).
- Liu, L.X., Guo, H.J., Zhao, L.S., Zhao K. Analysis of ^7Li ion beam induced DNA variations in wheat and plasmid pUC18. In: *Annual report for Beijing National Tandem Accelerator Laboratory 2006*, Beijing: Atomic Energy Press, Beijing, 132-133 (2007b).
- Liu, L.X., Zhao, L.S., Guo, H.J., Li, J.C., Wang, J., Zhao, S.R., Zheng, Q.C. Study on mutagenic effects of mixed particle field irradiation in winter wheat. *Science technology and engineering* **21**, 1642-1645 (2005B).
- Han, W.B., Liu, L.X., Guo, H.J., Zhao, L.S., Li, J.C., Zhang, S.P., Wang, C.S., Zhao, S.R. SSR analysis on M_1 variation of wheat irradiated by mixed high energy particle field. *Acta Agriculturae Nucleatae Sinica* **20**, 165-168 (2006).
- Liu, L.X., Han, W., Guo, H., Zhao, L., Zhao, S., Li, J., Wang, J., Zheng, Q. Cytological effects of mixed particle field irradiation in wheat. *Acta Agriculturae Nucleatae Sinica* **19**(5), 327-331 (2005c).

Establishment of Ion Beam Technology for Breeding

A Tanaka

Abstract

We have begun to investigate the characteristics of ion beams for inducing mutation from a molecular to a phenotypic level. Mutation induction rates were investigated using known visible *Arabidopsis* mutant phenotypes, such as *glabra* (*gl*) and *transparent testa* (*tt*). These observations indicated that mutation frequencies induced by carbon ions were twenty-fold higher than those induced by electrons. Molecular analyses showed that half of the mutants induced by ion beams possessed large DNA alterations, while the rest had point-like mutations. The common feature of mutations induced by ion beams is the deletion of several bases. It is possible that ion beams induce a limited number of large and irreparable DNA lesions, resulting in the production of null mutations that show a new mutant phenotype. Novel mutants, such as those that are UV-B resistant, have serrated petals and sepals, or lack anthocyanins, have been induced by 220 MeV carbon ions in *Arabidopsis*. The mutated genes were found to encode novel and key proteins for each process. In chrysanthemum and carnation, several kinds of flower-color and flower-form mutants that have never been produced by Gamma-rays or X-rays were induced by carbon ions. These observations indicate that the characteristics of mutations induced by ion beams are high frequency and broad spectrum, and produce novel mutants. Many breeding programmes are using mutants induced by ion beams and successfully producing useful new crop varieties.

Introduction

A number of studies on plant mutagenesis by ionizing radiation have been carried out since mutations were induced using X-rays in maize and barley by Stadler in 1928 [1]. The biological effects of ion beams have also been investigated and it has been found that ion beams show a high relative biological effectiveness (RBE) in lethality, mutation, and so on, compared to low linear energy transfer (LET) radiation such as Gamma-rays, X-rays and electrons [2]. As ion beams deposit high energy on a local target, it has been suggested that ion beams induce predominantly single- or double-strand DNA breaks with damaged end groups that are unable to be repaired easily [3]. Therefore, it seems plausible that ion beams frequently produce large DNA alterations, such as inversions, translocations and large deletions, rather than point mutations. However, the characteristics of mutations induced by ion beams have rarely been studied. On the base of the Consultative Committee for Advanced Radiation Technology in Japan, the Takasaki Ion Accelerator Advanced Radiation Application (TIARA) was established and basic research on plant mutation by ion beams was began in 1991. We first investigated the characteristics of ion beams on mutation induction. For over 16 years, the biological effects of ion beams have been studied and novel mutants and varieties of crops have been consistently and efficiently produced using mutations induced by ion beams. At present,

more than 100 research projects utilize ion beam irradiation produced by several irradiation facilities in Japan.

Irradiation methods

Ion beam irradiation of plant materials has been carried out in the following facilities: TIARA of the Japan Atomic Energy Agency (JAEA), the RIKEN Accelerator Research Facility (RARF), the Wakasa Wan Energy Research Center Multi-purpose Accelerator with Synchrotron and Tandem (W-MAST), and the Heavy Ion Medical Accelerator in Chiba (HIMAC) of National Institute of Radiological Sciences (NIRS). As a representative ion source, TIARA was established as the ion beam facility for exclusive use on biological and material science [4]. The effects of ion beams on plant materials have been investigated using several plant species including *Arabidopsis*, rice, barley, tobacco and chrysanthemum. Several kinds of energies and ions, such as helium (He), carbon (C), neon (Ne) and argon (Ar), were used in these studies, with 220MeV C ions being the most common. All ions were generated from the AVF-cyclotron in TIARA (Fig. 1) [5]. The physical properties of the 220 MeV carbon ions are as follows: Incident energy at the target surface was 17.4 MeV/u, mean linear energy transfer (LET) in a target (0.5 mm thick) was estimated to be 121.5 keV/ μ m as water equivalent, and the range of ions was ca. 1.1 mm (Table 1). These physical properties were calculated using an ELOSS code programme, a type of modified OSCAR code programme. Particle fluences of the ions were determined using a diethyleneglycol-bis-allylcarbonate (CR-39) film track detector. In general, ion beams are scanned at around 70 x 70mm, and exit the vacuum chamber through a beam window of 30 μ m titanium foil. The sample is placed under the beam window and irradiated in the atmosphere. In the case of *Arabidopsis* or tobacco seeds, 100-3,000 seeds are sandwiched between kapton films (8 μ m thick) to make a seed monolayer for homogeneous irradiation. In the case of rice or barley seeds, the embryo side faces the ion beams. Tissue cultures, such as those of ornamental explants, calluses and shoot primordia are contained in an aseptic petri dish that is irradiated directly, except that the lid of dish is replaced by a thin film in order to decrease the loss of ion beam energy. A sample is irradiated within 2 minutes.

Table 1. Physical parameters of ions produced in TIARA. Modified from [5]

Ions	Total energy (MeV)	Specific energy (MeV/u)	Projectile range (in water, mm)	LET (keV/ μ m)
$^4\text{He}^{2+}$	100	25.0	6.2	9.1
$^4\text{He}^{2+}$	50	12.5	1.7	19
$^{12}\text{C}^{6+}$	320	26.7	2.3	86
$^{12}\text{C}^{5+}$	220	18.3	1.1	122
$^{20}\text{Ne}^{7+}$	260	13.0	0.3	504

Biological effects of ion beams

Biological effects, such as seed germination, plant survival and chromosome aberrations were first investigated because they provide important

Japan Atomic Energy Agency (JAEA), Takasaki, Japan

E-mail: tanaka.atsushi@jaea.go.jp

indices to determine the properties of the ion beams used for mutagenesis in plants [5]. Most efforts were focused on the LET-dependence of survival of plants from treated seeds. In general, all the experiments showed a peak of RBE for the survival of treated seeds above ca. 230 keV/ μm (Fig. 2). Using carbon ions with different LET, Hase, *et al.* [6] found that the RBE for plant survival and chromosome aberrations in tobacco increased with increasing LET and showed the highest value at 230 keV/ μm . Shikazono, *et al.* [7] found that the LET of the peak RBE for lethality of *Arabidopsis* was over 221 keV/ μm for carbon ions and over 350 keV/ μm for neon and argon ions. This data suggests that the LET for maximum of RBE for plant lethality is higher in seeds than in mammalian cells.

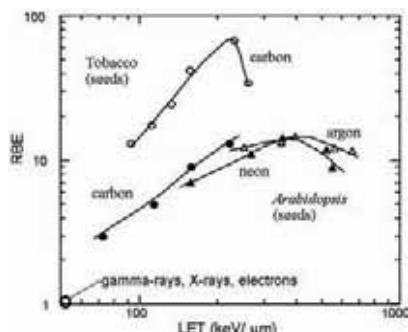

Figure 1 AVF-cyclotron (Left) and Irradiation Apparatus for Seed (IAS) (Right) in TIARA.



Figure 2 The relative biological effectiveness (RBE) of lethality as a function of linear energy transfer (LET) (from [6] and [7]).

The effects of LET on chromosomal aberrations was also investigated. The frequencies of mitotic cells with chromosome aberrations, such as chromosome bridges, acentric fragments and lagging chromosomes, were much higher for ion beams than for Gamma-rays [8]. The highest RBE was 52.5 at 230 keV/ μm of LET [6]. The frequency of cells with chromosome aberrations did not decrease after fractionated irradiation with carbon ions, although a clear decrease was observed after exposure to electrons [9]. Recently, DNA double-strand breaks (DSBs) were quantified in tobacco protoplasts using pulsed-field gel electrophoresis [10]. Initial DSB frequency depended on LET and the highest RBE was obtained at 124 and 241 keV/ μm carbon ions. These results indicate that the biological effects induced by ion beams were greater than those induced by low LET radiation, and that DNA damage induced by ion beams is likely to be irreparable.

Recently, Kazama, *et al.* [11] showed that a LET of 30 keV/ μm (N ion) was most effective for inducing albino plants of *Arabidopsis*, indicating that the relationships with LET differ between mutation induction, plant lethality, chromosome aberrations and DSBs.

Characteristics of mutations induced by ion beams

Mutation frequency

Mutation frequency was investigated on a gene locus basis using visible known *Arabidopsis* mutant phenotypes, such as *transparent testa* (*tt*), in which the seed coat is transparent because of the lack of pigments, and *glabrous* (*gl*), in which no trichomes are produced on leaves and stems [12]. The average mutation frequencies of *tt* and *gl* loci induced by C ions was twenty-fold higher than those induced by electrons (Table 2, [13]). Mutation frequency is generally calculated as a unit per dose for radiation induced mutations. However, it is important to compare the mutation frequency as number of mutants per irradiated population when considering the use of mutants for practical purposes, such as agriculture for example. Carbon ions can produce *Arabidopsis* mutants at a rate four times higher than electrons, because carbon ions need one fifth of the dose (i.e. RBE=5) to induce the same biological effects as electrons [5].

Table 2. Mutation frequency induced by carbon ions and electrons [13]

Mutagen (dose)	No. of M2 plants	Locus	Mutation frequency / locus / diploid cell / dose (Gy) ($\times 10^{-6}$)
Carbon ions (150 Gy)	104,088	<i>tt</i> (tt3-tt7, tt18, tt19) <i>gl</i> (gl1-gl3, ttg1, ttg2)	1.9 (20 times)
Electrons (750 Gy)	80,827	<i>tt</i> (tt3-tt7, tt18, tt19) <i>gl</i> (gl1-gl3, ttg1, ttg2)	0.097

Mutation spectrum

In order to elucidate the features of ion beams as a new mutagen, the mutation spectrum induced by ion beams was compared with that induced by low LET radiation. To do this, Nagatomi, *et al.* [14] investigated the spectrum of mutations in flower color using chrysanthemum cv. Taihei with pink-color petals. We studied mutation induction in plants regenerated from irradiated explants of floral petals. Most flower color mutants induced by Gamma-rays were light pink, while a few were dark pink in color. By contrast, the color spectrum of the ion beam-induced mutants shifted from pink to white, yellow and orange. Furthermore, flower mutants induced by C ions showed complex patterns of coloration, and striped color types, that have never been obtained by Gamma-ray irradiation of this cultivar. It was suggested, therefore, that the mutation spectrum of flower color induced by ion beams is broad and that novel mutation phenotypes can be obtained.

Table 3. Mutation spectrum of flower color in carnation. Modified from [15].

Mutagen	Mutation frequency ($\times 10^{-1}$ %)									
	Light pink	Pink	Dark pink	Red	Salmon	Yellow	Cream	Stripe	Minute striped	Complex
EMS	0	5.2	0	1.0	0	0	0	3.1	0	0
Soft X-rays	1.7	8.4	0	3.4	0	0	0	0	0	0
Gamma-rays	1.7	2.6	0	1.7	0	0	0	0	11.3	0
Carbon ions	2.4	4.7	2.4	3.5	2.4	2.4	1.2	3.5	0	2.4

The mutation spectrum of flower color and flower shape of carnation was investigated by Okamura, *et al.* [15]. When the carnation variety Vital, whose phenotype is spray type with cherry pink flowers and frilly petals, was investigated, flower color mutants such as pink, white and red were obtained by X-ray irradiation, whereas the color spectrum of the mutants obtained by carbon ion irradiation was far wider and included pink, light pink, salmon, red, yellow, complex and striped types (Table 3). In addition, many kinds of round shaped petals were induced. These data indicated that ion beams can induce novel flower color and shape with high frequency.

Molecular mechanisms of mutation

C ion and electron-induced *Arabidopsis* mutants were compared at molecular (DNA) level [12, 13]. In the case of C ions, 14 loci out of 29 possessed intragenic point-like mutations, such as base substitutions, or deletions of several to 100 of bases (Table 4). Fifteen out of 29 loci however, possessed intergenic DNA rearrangement ('large mutations') such as chromosomal inversions, translocations, and deletions. In the case of electrons, nine alleles out of 12 loci had point-like mutations and three out of 12 loci had DNA rearrangements. Sequence analysis revealed that C ion-induced small mutations were mostly short deletions. Furthermore, analysis of chromosome breakpoints in large mutations revealed that C ions frequently deleted small regions around the breakpoints, whereas electron-irradiation often duplicated these regions. These results could imply that different types of non-homologous end joining pathways operate in response to the mutations induced by the two radiation types and that C ion-induced mutations are mostly likely to result in nulls.

Table 4. Characteristics of mutation induced carbon ions and electrons. Modified from [13]

	Carbon ions		Electrons	
	Point-like mutation	Large DNA arrangement	Point-like mutation	Large DNA arrangement
Mutation (TT, GL loci)	48%	52%	75%	25%
	(as 100%)		(as 100%)	
Deletion	79%		44%	
Base substitution	14%		44%	
Insertion	7%		11%	
		(as 100%)		(as 100%)
Deletion		65%		13%
Duplication		24%		75%

New varieties and mutants

Model plants

Several new *Arabidopsis* mutants, and the gene responsible for these mutations, were identified following ion beam mutagenesis [16]. Ultraviolet light-B (UV-B) resistant or sensitive mutants were obtained, and the genes responsible have been identified [17, 18, 19]. New anthocyanin-accumulating or anthocyanin-defective mutants were also obtained and some of the genes responsible have been identified [20, 12, 21]. A novel flower mutant, *frill1*, which has serrated petals and sepals, and the gene responsible for this phenotype have been found [22, 23]. A novel auxin mutant, the *aar1-1*, was also obtained [24]. In *Lotus japonicus*, which is used as a model leguminous plant, a novel hypernodulation mutant, named *klavier* (*klv*), was isolated following irradiation with helium ions [25]. Thus, not only new mutants but also new genes can be discovered using ion beam-induced mutagenesis.

Crops

In crops, ion beams have been used for inducing mutants resistant to major diseases. Mutants resistant to bacterial leaf blight and blast disease were induced in rice [26]. Higher mutation frequency was found in the ion beam treatment compared to Gamma-rays or thermal neutrons. Two mutant lines of yellow mosaic virus-resistant barley were found in a screen of ca. 50,000 M_2 families [27]. By exposure of tobacco anthers to ion beams, mutants resistant to potato virus Y have been obtained [28]. A high frequency (2.9~3.9%) of resistant mutants was obtained by irradiation with carbon and helium ions. Recently, banana mutants tolerant to black Sigatoka *in vitro* were induced by carbon ions [29]. Eight candidates from two varieties were selected for resistance in the field.

In addition to disease resistance, chlorophyll mutants were frequently observed in these crops. About 2.1% of the M_2 generation derived from barley seed exposed to carbon ions were chlorophyll-deficient mutants [30]. An albino mutant of tobacco was obtained by irradiation with nitrogen ions at an early stage of embryonic development [31]. A high frequency (11.6%) of chlorophyll-deficient mutants, including an albino mutant, were obtained in rice by irradiation with neon ions [32]. A variegated yellow leaf mutant of rice, which could be induced by activation of endogenous transposable element, was induced by carbon ions [33].

Ornamental flowers

As described above, complex and stripe types of flower color have been obtained in chrysanthemum [14]. Morphological mutant phenotypes have also been observed in chrysanthemum [34]. One of these mutations, a reduced axillary flower bud mutant, was induced by carbon ions for the first time [35]. Recently, by re-irradiation of this mutant using carbon ions, the ideal characters of not only a few axillary flower buds but also low temperature flowering were obtained [36]. In addition to the carnation varieties described above [15], mutants of petunia with altered flower color and form have been induced by ion beams [37]. In rose, mutants with more intense flower colors or mutants in the number of petals, flower size and shape have been obtained [38]. Mutants induced by nitrogen or neon ions in *Torenia* include two groups of flower color mutants, ones that lack genes required for color or pigment production and others in which their expression is altered [39]. In cyclamen, ion beam irradiation of the tuber was found to be much more useful for changing flower characteristics than irradiation of other materials such as callus, somatic embryo, and so on [40].

Trees

Ion beams have also been used for generating mutants for tree breeding. Wax mutants and chlorophyll mutants such as Xanta and Albino were obtained in the forest tree, Hinoki cypress [41]. Shoot explants of *Ficus thunbergii* were irradiated with several kinds of ion beams to increase the capability of plants to assimilate atmospheric nitrogen dioxide [42]. A mutant variety with 40-80% greater capability to assimilate atmospheric nitrogen dioxide has been induced.



Figure 3 Novel varieties and mutants induced by ion beams. From top left to right: New chrysanthemum complex-color variety, "Ion-no-Seiko"; New rose-flower type carnation variety; New Osteospermum variety "Vient Flamingo"; New chrysanthemum variety "Aladdin," which has reduced axillary flower buds. From bottom left to right: one-month old plants of *Arabidopsis* wild-type (upper rank) and UV-B resistant mutants (lower rank) under high UV-B condition; Flavonoid accumulating seed of the *Arabidopsis tt19* mutant; New barley mutant resistant to barley yellow mosaic virus; New variety "KNOX" of *Ficus thunbergii*, which has a high capability for the uptake and assimilation of atmospheric nitrogen dioxide.

Future prospects

Ion beams can be utilized as a novel mutagen to generate new mutants for basic research and to create new varieties as novel genetic resources. New genes, found using ion beams for mutagenesis, deliver new knowledge that can be exploited in biotechnology and molecular biology. In

the applied sciences, several flower varieties have already been commercialized following ion beam mutagenesis. For example, new varieties of carnation with different flower colors and/or shapes have been produced both in Japan and Europe, and new chrysanthemum varieties, with few axillary flower buds, named Aladdin and Aladdin 2, are being produced by more than 30 companies and associations. At present, not only Japanese but also other Asian scientists have started to use ion beams to induce mutations suitable for crop breeding. In the future, induced mutagenesis using ion beams will undoubtedly be used not only for model or decorative plants but also to develop plants that resist biotic and abiotic challenges or have potential for phytoremediation. These will have the potential to increase food security and resolve global environment problems.

ACKNOWLEDGEMENTS

This work has been achieved with the persistent help of the people involved in the research and development of ion-beam plant breeding. Therefore, I respectfully thank all the technical staff who established the ion beam irradiation systems and the researchers who undertook plant mutagenesis and breeding by the use of ion beams.

BIBLIOGRAPHY

- Stadler, L.J. Mutations in barley induced by X-rays and radium. *Science* **68**, 186-187 (1928).
- Blakely, E.A. Cell inactivation by heavy charged particles, *Radiat. Environ. Biophys.* **31**, 181-196 (1992).
- Goodhead, D.T. Molecular and cell models of biological effects of heavy ion radiation. *Radiat. Environ. Biophys.* **34**, 67-72 (1995).
- Fukuda, M. *et al.* New applications of ion beams to material, space, and biological science and engineering. In: *Charged particle and photon interactions with matter* (Mozumder A. and Hatano Y., Ed.) Marcel Dekker Inc., New York, 813-859 (1995).
- Tanaka, A. *et al.* Effects of heavy ions on the germination and survival of *Arabidopsis thaliana*. *Int. J. Radiat. Biol.* **72**, 121-127 (1997).
- Hase, Y. *et al.* Reduction of survival and induction of chromosome aberrations in tobacco irradiated by carbon ions with different LETs. *International Journal of Radiation Biology* **78**, 799-806 (2002).
- Shikazono, N. *et al.* LET dependence of lethality in *Arabidopsis thaliana* irradiated by heavy ions. *Radiation and Environmental Biophysics* **41**, 159-162 (2002).
- Hase, Y. *et al.* Biological effects of ion beams in *Nicotiana tabacum* L. *Radiat Environ Biophys*, **38**, 111-115 (1999).
- Shimono, K. Effect of fractionated exposure to carbon ions on the frequency of chromosome aberrations in tobacco root cells. *Radiat. Environ. Biophys.* **40**, 221-225 (2000).
- Yokota, Y. *et al.* Initial yields of DNA double-strand breaks and DNA fragmentation patterns depend on linear energy transfer in tobacco BY-2 protoplasts irradiated with helium, carbon and neon ions. *Radiat. Res.* **167**, 94-101 (2007).
- Kazama, Y. *et al.* LET-dependent effects of heavy-ion beam irradiation in *Arabidopsis thaliana*. *Plant Biotechnology* **25**, 113-117 (2008).
- Shikazono, N. *et al.* Mutation rate and novel tt mutants of *Arabidopsis thaliana* induced by carbon ions. *Genetics* **163**, 1449-1455 (2003).
- Shikazono, N. *et al.* Analysis of mutations induced by carbon ions in *Arabidopsis thaliana*. *Journal of Experimental Botany* **56**, 587-596 (2005).
- Nagatomi, S. *et al.* Mutation induction on chrysanthemum plants regenerated from *in vitro* cultured explants irradiated with C ion beam. *TIARA annual report 1995* **5**, 50-52 (1996).
- Okamura, M. *et al.* Wide variety of flower-color and -shape mutants regenerated from leaf cultures irradiated with ion beams. *Nucl. Inst. and Meth. in Phys. Res.* **B206**, 574-578 (2003).
- Tanaka, A. Mutation induction by ion beams in *Arabidopsis*. *Gamma Field Symposia* **38**, 19-28 (1999).
- Tanaka, A. *et al.* An ultraviolet-B-resistant mutant with enhanced DNA repair in *Arabidopsis*. *Plant Physiology* **129**, 64-71 (2002).
- Sakamoto, A. *et al.* Disruption of the AtREV3 gene causes hypersensitivity to ultraviolet B light and gamma-rays in *Arabidopsis*: Implication of the presence of a translation synthesis mechanism in plants. *Plant Cell* **15**, 2042-2057 (2003).
- Hase, Y. *et al.* A mutation in the *uvi4* gene promotes progression of endo-reduplication and confers increased tolerance towards ultraviolet B light. *Plant Journal* **46**, 317-326 (2006).
- Tanaka, A. *et al.* A new *Arabidopsis* mutant induced by ion beams affects flavonoid synthesis with spotted pigmentation in testa. *Genes Genet. Syst.* **72**, 141-148 (1997).
- Kitamura, S. *et al.* TRANSPARENT TESTA 19 is involved in the accumulation of both anthocyanins and proanthocyanidins in *Arabidopsis*. *Plant Journal* **37**, 104-114 (2004).
- Hase, Y. *et al.* FRL1 is required for petal and sepal development in *Arabidopsis*. *Plant Journal* **24**, 21-32 (2000).
- Hase, Y. *et al.* Ectopic endoreduplication caused by sterol alteration results in serrated petals in *Arabidopsis*. *Journal of Experimental Botany* **56**, 1263-1268 (2005).
- Rahman, A. *et al.* A small acidic protein 1 (SMAP1) mediates responses of the *Arabidopsis* root to the synthetic auxin 2,4-dichlorophenoxyacetic acid. *Plant J.* **47**, 788-801 (2006).
- Oka-Kira, E. *et al.* *klavier (klv)*, a novel hyper-nodulation mutant of *Lotus japonicus* affected in vascular tissue organization and floral induction. *Plant Journal* **44**, 505-515 (2005).
- Nakai, H. *et al.* Studies on induced mutations by ion beam in plants. *JAERI-Review* **19**, 34-36 (1995).
- Kishinami, I. *et al.* Mutations induced by ion beam (C5+) irradiation in barley. *JAERI TIARA Annual Report* **3**, 30-31 (1994).
- Hamada, K. *et al.* Potato virus Y-resistant mutation induced by the combination treatment of ion beam exposure and anther culture in *Nicotiana tabacum* L. *Plant Biotechnology* **16**, 285-289 (1999).
- Reyes-Borja, W.O. *et al.* Alteration of resistance to black Sigatoka (*Mycosphaerella fijiensis* Morelet) in banana by *in vitro* irradiation using carbon ion-beam. *Plant Biotechnology* **24**, 349-363 (2007).
- Kishinami, I. *et al.* Studies on mutation induction of barley by ion beams, *Abstracts of the fifth TIARA research review meeting*, 165-166 (1996) (in Japanese).
- Bae, C.H. *et al.* Regulation of chloroplast gene expression is affected in *ali*, a novel tobacco albino mutant. *Annals of Botany* **88**, 545-553 (2001).
- Abe, T. *et al.* Chlorophyll-deficient mutants of rice demonstrated the deletion of a DNA fragment by heavy-ion irradiation. *Journal of Radiation Research* **43**, 157-161 (2002).
- Maekawa, M. *et al.* Induction of somatic instability in stable yellow leaf mutant of rice by ion beam irradiation. *Nuclear Instruments and Methods in Physics Research* **B206**, 579-585 (2003).
- Ikegami, H. *et al.* Mutation induction through ion beam irradiations in protoplasts of chrysanthemum. *Bull. Fukuoka Agric. Res. Cent.* **24**, 5-9 (2005) (in Japanese).
- Ueno, K. *et al.* Effects of ion beam irradiation on chrysanthemum leaf discs and sweetpotato callus. *JAERI-Review* **35**, 44-46 (2002).
- Ueno, K. *et al.* Additional improvement of chrysanthemum using ion beam re-irradiation. *JAERI-Review* **25** 53-55 (2004).
- Okamura, M. *et al.* Advances of mutagenesis in flowers and their industrialization, In: *Floriculture, ornamental and plant biotechnology Vol.1*, Global Science Books, 619-628 (2006).
- YAMAGUCHI, H. *et al.* Mutation induced with ion beam irradiation in rose. *Nuclear Instruments and Methods in Physics Research* **B206**, 561-564 (2003).
- Miyazaki, K. *et al.* Flower pigment mutations induced by heavy ion beam irradiation in an interspecific hybrid of *Torenia*. *Plant Biotechnology* **23**, 163-167 (2006).
- Sugiyama, M. *et al.* Biological effects of heavy-ion beam irradiation on cyclamen. *Plant Biotechnology* **25**, 101-104 (2008).
- Ishii, K. *et al.* RAPD analysis of mutants obtained by ion beam irradiation to hinoki cypress shoot primordial. *Nuclear Instruments and Methods in Physics Research* **B206**, 570-573 (2003).
- Takahashi, M. *et al.* Effects of ion beam irradiation on the regeneration and morphology of *Ficus thunbergii* Maxim. *Plant Biotechnology* **22**, 63-57 (2005).

Mutagenic Mechanisms of Ion Implantation in Plants

H Y Feng, G Yang & Z L Yu*

Abstract

Ion beam implantation, as a new mutation technique, has been widely used in mutation breeding, and great achievements have been made for both the agriculture and fermentation industry. The mechanism underlying ion beam-induced mutagenesis has been a topic of research in recent years. In this paper, we focus on the initial physical process of ion implantation into organisms, noting that energy deposit, mass deposit and charge transfer of the implanted ions into target organisms are the main contributors to the biological effects. Recent studies of remote damage following ion beam implantation in plant samples are also included. It was observed that targeted ion implantation of the shoot apical meristem (SAM) of *Arabidopsis* embryos induces damage to the root apical meristem (RAM), indicating long distance systemic effects in intact organisms. Further studies showed that the generation of reactive oxygen species upon ion implantation could play important roles in the observed systemic effects.

Introduction

In the mid-1980's, some pioneering work was carried out by the authors' laboratory, where 30 keV nitrogen ions were implanted into dry rice seeds. When the implantation dose was sufficiently high, yellow stripes were seen on the leaves of rice plants grown from the seeds, and these characteristics could be stably inherited by later generations. This phenomenon indicated that ion implantation could become a new mutation technique. In China, six key laboratories of ion beam bioengineering have been established in six provinces, and ion beam mutation is one of the most important projects undertaken by three key ministries' laboratories and three national biochemical engineering centers. These laboratories and centers have been equipped with 19 ion beam bioengineering facilities to serve mutation breeding for 42 plant breeding units in 22 provinces. From the authors' laboratory alone, 23 new varieties and 35 new strains of industrial microbes have been bred by ion beam mutation since 1994 [1]. These varieties cover almost all main crops, including rice, wheat, maize, cotton, soybean, tomato and sweet potato. The varieties are highly welcomed by peasants, due to their high yield and quality, and widely planted in certain areas along the Yangzi River in southern-eastern China. Of the microbial strains, two particularly excellent new strains, for producing vitamin C and arachidonic acid, respectively, increased sugar-to-acid transformation rate greatly, thereby increasing fermentation efficiency. Both strains have been adopted by manufacturers. Presently China is the main producer of vitamin C in the world, and the second largest supplier of arachidonic acid.

While ion beam mutation breeding has achieved great profit in its application, the interactions between the implanted ions and complicated organisms have also been studied intensively. In a previous pub-

lication [2], the authors proposed that a combination of energy absorption, mass deposition, and charge transfer of energetic ions in the seeds resulted in the biological effects. Since then, scientists have been trying to demonstrate the interactions between the energy, mass and charge of the implanted ions and organic molecules, and obtained some significant results. A key question is the traveling range of the implanted ions in the seeds. According to stopping power theory for ions penetrating into dense matter, e.g. metal and semiconductor, the range of incident ions with energy 30-200 keV cannot exceed 1 μ m, but a typical thickness of the rice seed coat is 40-200 μ m. It seems impossible that ions with such a low energy level can penetrate through the coat. To address this question, the National Natural Science foundation of China supported a series of studies in this field. It has been discovered, through various experiments, that the penetrating depth of 30-200 keV ions in plant seeds can be in the range of 60-135 μ m, and the damage distance can be as far as 800 μ m [1].

Recently, studies on the mechanisms of mutagenesis by ion beam mutation have seen substantial progress. It has been observed that targeted ion implantation of shoot apical meristems (SAM) of *Arabidopsis* embryos induces long-distance systemic effects on root apical meristems (RAM). This provided important new information for understanding the effects of ion beam mutagenesis.

Here, we focus on the interactions between the implanted ions, bio-molecules and plant seeds, discussing the ion beam-induced mutation from two main aspects, the original physico-chemical process and the systemic effects.

Initial process of ion implantation into organisms

To reveal the interaction process of the implanted ions with complicated biological objects, some simplified models, which use simplified organic molecules or botanical slices consisting of complicated biological objects, were used as targets. Using these models, an initial process of ion implantation into organisms could be studied independent of subsequent or final biological effects.

Energy loss features [2]

According to stopping power theory, the total energy loss per unit path of a single incident ion in the target material is calculated by:

$$-\frac{dE_1}{dx} = N[S_n(E_1) + S_e(E_1)] \quad (1)$$

where E_1 is the incident ion energy, N is the number density of the target material, and $S_n(E_1)$ and $S_e(E_1)$ are the nuclear stopping and electronic stopping powers, respectively.

The basis of (1) is the assumption of a continuous, homogeneous distribution of the atomic volume density, which is much greater than the

Key Laboratory of Ion Beam Bioengineering, Institute of Plasma Physics, Chinese Academy of Sciences and Anhui Province, P.O. Box 1126, Hefei 230031, China

* Corresponding author. E-mail: zlyu@ipp.ac.cn

ion range. For organisms, there are a lot of the free voids, e.g. biological holes or channels in organisms, which can be considered to be transparent to the implanted ions in vacuum. Furthermore, the dimensions would be larger and larger with increasing doses of the implanted ions, or new holes or channels could be produced. So, the target atom volume density along the ion incident direction after implantation to a certain dose is a periodic function. In a period interval $(-l, l)$, atom volume density can be regarded as a Fourier series, and after operation the total energy loss of a single incident ion in the target material is calculated by:

$$-\frac{dE_1}{dx} = \left(\frac{1-\alpha}{2} \sum_{n=1}^N \frac{N}{\sin n\pi} \left[\cos n\pi x/l - (-1)^n \sin n\pi x/l - \sin n\pi x/l + \cos n\pi x/l \right] \right) \times [S_n(E_1) + S_e(E_1)] \quad (2)$$

where E_1 is the incident ion energy, N is the number density of the target material, and $S_n(E_1)$ and $S_e(E_1)$ are the nuclear stopping and electronic stopping powers, respectively. α is related to the ion implantation dose and the voids fraction in organism, calculated by:

$$\alpha = \frac{2rD}{N_A} + 2\eta - 1 \quad (3)$$

where D is dose of the implanted ions, N_A is the target area density. η is the vacancy volume intrinsically in the organism (e.g. for crop seeds, $\eta > 10\%$), r is a coefficient related to the particle emission induced by the ion, electron sputtering, and chemical sputtering. The coefficient r is considerable. For example, the emission coefficient r is 290 lactamine molecules/ion or 3.8×10^3 atoms/ion with nitrogen ion sputtering on a lactamine film, and is 3 to 4 orders of magnitude greater than that of for the elements of C, H, N and O calculated using classical collision cascade theory.

It can be seen from eq. (2) that fluctuation of the incident ion energy loss along the direction of the ion trajectory is a feature of beaded energy deposition, because of the voids in the target organism. Ion beams can etch away the coat from the surface of the biological sample and dig paths that could connect the voids (that in a natural situation can be isolated from each other) in the direction of ion incidence. Thus, later incident ions can penetrate longer and longer distances until finally they enter the embryonic cells, as in the case of ion implantation into crop seeds.

Mass deposit effects

For ion implantation of organisms, when the ion energy is decreased down to chemical reaction range, the implanted ions are deposited in the target, and may react with nearby atoms and molecules. The process can be demonstrated by nitrogen ion implantation into NAA (Naphthyl Acetic Acid, with MW of 186) [3]. There is no nitrogen atom in the molecular structure of NAA. After nitrogen cation implantation into NAA, there are new molecular structures in the implanted NAA sample analyzed by GC-MS. Its mass spectrum suggests a molecular weight of 267g/mol. This new molecule could contain a nitrogen atom according to chemical valence theory (Fig. 1). This means that ion implantation not only induces damage of the target molecules, i.e. producing molecular fragments, but also results in the formation of new molecules because of reaction between displaced atoms, interstitials or fragments with the implanted ions if they are active elements.

At the same energy, Fe^+ , P^+ and N^+ with doses of 1×10^{13} , 1×10^{14} , 1×10^{15} and 1×10^{16} ions/cm² were separately implanted into *Arabidopsis thaliana* seeds. cDNA-AFLP analysis was performed to show variations at

the mRNA level and genetic stability for three generations (Fig. 2). The gene variation rate of the M_0 generation implanted by nitrogen ions was the highest among the three types of ions, reaching 8.15%. Some gene variation was repaired in the successive generations for all three types of ions, but the gene mutation rate of nitrogen ion implantation was also the highest in M_2 . These results illustrate that the implantation of ions with different mass could lead to biological effects at different levels.

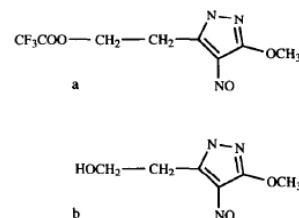

Figure 1 The structure of main product in ion implantation of α -NAA. (a) derivatives of product; (b) product.

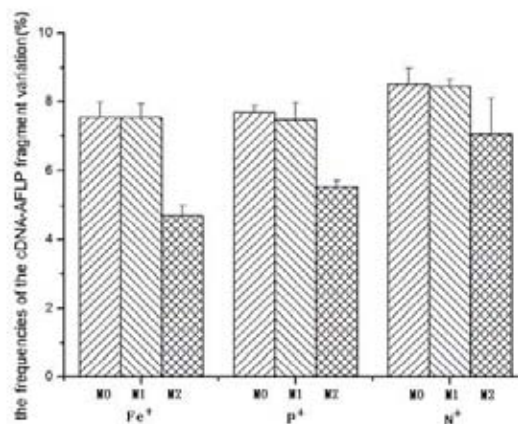

Figure 2 The frequencies of the cDNA-AFLP fragment variation in the M_0 , M_1 , M_2 generation Arabidopsis after Fe^+ , P^+ , N^+ ion implantation (provided by Prof. G. F. Zhang).

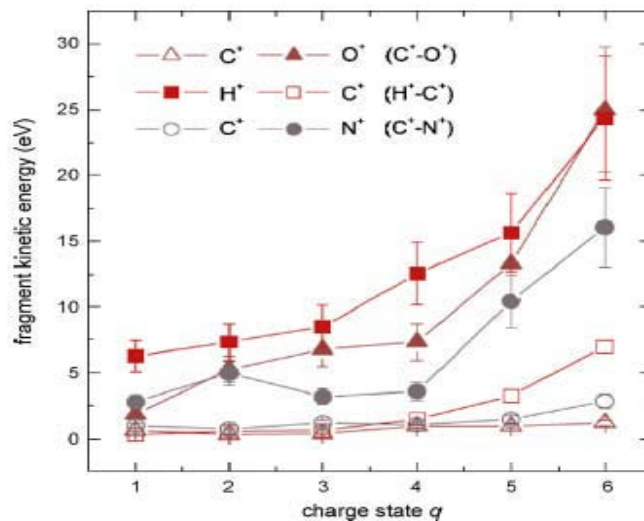

Figure 3 Kinetic energies of atomic fragment ions from 4 keV/amu (C^+ : 2 keV/amu) Cq^+ -induced fragmentation of thymine [4].

Charge transfer effects

In terms of ion-sputtering bio-molecules, the energies of the ion-induced fragment ions and emitted electrons are particularly important in explaining mechanism of long-distance damage in ion implantation of an organism (see Section 4). If the energy of emitted fragments is sufficiently high, these fragments will induce further damage to surround-

ing molecules. Fig. 3 shows that the energies of fragments are depend on the charge number of incident ions [4].

Since biological organisms are not good electrical conductors, the accumulated surface charge is not immediately released. Instead, the charge is maintained for a time long enough for changes in the electrical characteristics of the sample surface to be examined by a capillary-electrophoresis method. The accumulation of surface charge not only affects the electrical characteristics of biological organisms, but also may lead to changing an electrostatic field across the cellular membrane, influencing various complicated biochemical processes, further resulting in cellular damage.

The charge transfer effects of ion implantation into *Arabidopsis thaliana* seeds were studied using H^+ , O^+ and O^- with doses of 1×10^{13} , 1×10^{14} and 1×10^{15} ions/cm² at a same energy level. Peroxidase activity, isozyme, semi-quantitative PCR and Western blotting analyses indicated that peroxidase level, protein contents, and enzyme activity caused by ions with higher charges were two to four times greater than that of the control group. However, the difference of these effects caused by ions with different charge numbers became less significant when the implantation dose increased. Fig. 4 shows that at the mRNA level, the expression of POD isoenzyme is clearly dependent on the ion charge state.

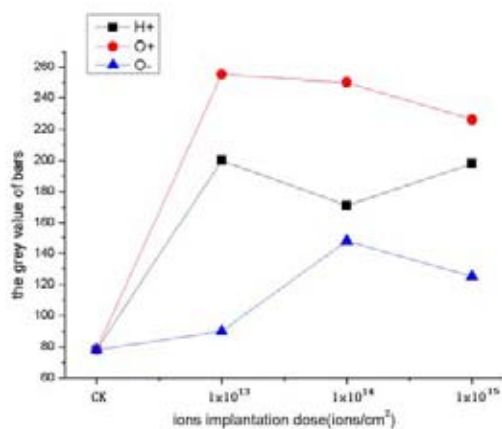

Figure 4 mRNA expression of POD isoenzyme after H^+ , O^+ , and O^- ion implantation. (Provided by Prof. G. F. Zhang)

Long- distance damage induced by ion implantation

The integrity of the embryo in the *Arabidopsis thaliana* seed is shown in Fig. 5 (middle). The average embryo was measured to be 300-500 μ m long, 200-270 μ m wide, and 50-70 μ m thick. The SAM (shoot apical meristem) and RAM (root apical meristem) cell groups of an *Arabidopsis* seed (Fig. 5, left) are almost entirely responsible for postembryonic development to elaborate plant architecture. The SAM and RAM are pivotal in generating a series of highly reproducible stages that imply tight control of the orientation and frequency of cell division as well as cell morphology and differentiation in development. The SAM is responsible for development of the aerial parts of the plant, while the RAM is responsible for development of the subterranean root system.

The right panel in Fig. 5 shows the 5 \times 5 etching spots on CR-39 after being hit by 1,000 protons. The diameter of each etching spot, showing the damaged area by proton irradiation, is about 9 μ m. Such a target resolution allows precisely targeted irradiation of cells in the defined SAM area of the intact embryo and ensures that no cells located more than 10 micrometers away receive any radiation exposure. It is impossible that protons could hit at cells in the RAM which is located ~150 μ m away from the SAM.

To determine the radiation-induced long-distance damage effects, embryos irradiated at the SAM and un-irradiated controls were examined for their root development. The density and length of the root hairs of seedlings grown from SAM-irradiated and control embryos were measured at day five post-irradiation. The root hair number of SAM-irradiated seedlings was 11 ± 3 , significantly lower than un-irradiated controls (16 ± 2 , $P < 0.01$), and the root hair length of irradiated seedlings (0.26 ± 0.14 mm) was only half of that of un-irradiated controls (0.58 ± 0.06 mm, $P < 0.01$). Similarly, the primary root elongation and lateral root initiation of SAM-irradiated seedlings were significantly inhibited. The mean length of the primary roots and the number of lateral roots per centimeter of primary root of irradiated seedlings were about 2.95 ± 0.46 mm and 0.94 ± 0.31 mm, respectively, significantly shorter or less than that of the controls (4.35 ± 0.53 mm for the length of primary root, $P < 0.01$, and 1.35 ± 0.32 for the number of lateral root per centimeter of primary root, $P < 0.05$) [5]. As mentioned above, 1,000 protons aimed at the defined SAM target could not irradiate the RAM. These results indicate that the non-irradiated RAM undergoes damage, leading to the inhibited root pattern development.

How the SAM irradiation induces damage in the RAM of the *Arabidopsis* embryo is not clear. In the present study, a treatment with DMSO recovered the primary root length compared with the un-irradiated controls, indicating that ROS (reactive oxygen species) induced by SAM-irradiation, or probably ROS-related auxin and auxin-dependent transcription processes, might be involved in radiation-induced SAM long-distance systemic responses.

Discussion

In Section 2 we reviewed the primary effects of implanted ions on organisms. Similar to other radiation, there are many coexisting factors, including energy, mass and charge of the implanted ions, affecting the biological effects, making it difficult to distinguish between direct and indirect effects of these factors. In Section 3 we reported recent studies that there are remote systemic responses in ion implantation into plant seeds. These studies also bring forward new questions. What is the connection between initial process of ion implantation and the remote effects? It was suggested in the experiments that ROS could be one of the factors, and there were fragment molecules and radicals produced in ion implantation into organisms. What other factors or signaling molecules would be induced and emitted/transferred in ion implantation into organisms, and how could the signals be transferred to longer distance from the irradiated site?

ACKNOWLEDGMENTS

The authors would like to thank Prof. G. F. Zhang and Dr. G. Yang for providing their experimental results.

BIBLIOGRAPHY

1. Feng, H. *et al.* Ion implantation of organisms. *Mat. Sci. & Technol.* **R54**, 3-4 (2006).
2. Yu, Z. *et al.* Introduction to ion beam biotechnology, Springer Press, New York, 77-80 (2006).
3. Huang, W. *et al.* Study of mass and energy deposit effects of ion implantation of NAA. *Radiat. Phys. Chem.* **48**, 3 (1996).
4. [4] T. Schlatholter, *et al.*, Ion-biomolecule interactions and radiation damage, *Nucl. Instrum. Meth.* **B233**, 62-69 (2005).
5. Yang, G. *et al.* Targeted irradiation of shoot apical meristem of *Arabidopsis* embryos induces long - distance bystander effects. *Radiation Research* **167**, 298-305 (2007).

Zinc Finger Nuclease-Mediated Gene Targeting in Plants

C Q Cai^{1,*}, M Ainley¹, J Miller², P Gregory², R Garrison¹, L Schulenberg¹, R Blue¹, A Worden¹, L. Baker¹, B Rubin-Wilson¹ & J F Petolino¹

Abstract

Zinc finger nucleases were used to facilitate homology driven repair and site-specific transgene integration in transgenic tobacco cell cultures. A target DNA sequence containing a non-functional, partial 3' PAT gene sequence flanked by zinc finger binding sites was stably integrated into BY2 suspension cultures using *Agrobacterium*-mediated transformation. A transgenic event containing a single integrated copy of the target sequence was used for gene targeting through co-transformation with two different *Agrobacterium* strains containing: i) donor DNA sequences comprising the 5' partial DNA fragment necessary to correct the non-functional PAT gene flanked by sequences homologous to the pre-integrated target DNA and ii) DNA that encoded a zinc finger nuclease that specifically recognized binding sites within the pre-integrated target. Two gene targeting strategies differing with respect to the distance between the zinc finger binding site and the homologous sequences were used. Gene targeting was demonstrated for both strategies as evidenced by the re-constitution of a functional PAT gene and was confirmed via molecular and biochemical analyses. Sequencing of recombined DNA confirmed that PAT gene reconstitution resulted from homology-driven repair at the zinc finger nuclease cleavage site. However, imperfect recombination resulting from non-homologous processes was also observed.

Introduction

Gene targeting can be used for making site-directed mutations, gene editing, deleting or inserting DNA sequences to pre-determined loci in the genome. Unfortunately, gene targeting in plants is not yet routine [1]. Attempts to enhance gene targeting efficiency in plants have included the use of negative selectable markers to enrich for cells that have undergone rare targeted integration [2] and over-expression of genes encoding proteins believed to be involved in natural recombination processes [3]. Nonetheless, the overwhelming occurrence of random DNA integration via non-homologous processes compared to homology-directed repair appears to be a major limitation to the routine application of gene targeting in plants [4].

Most recently, substantial increases in the frequency of gene targeting have been observed following the induction of DNA double stranded breaks in host cells and the apparent stimulation of cellular repair mechanisms [5]. Restriction enzymes whose recognition sites are rare in the plant genome have been shown to stimulate gene targeting following the formation and repair of DNA double stranded breaks in the host DNA [6]. Strategies to achieve targeted DNA double stranded breaks have been developed by fusing zinc finger DNA binding proteins with sequence-independent nuclease domains derived from Type IIS restriction endonucleases [7-8]. Site-specific mutagenesis in *Arabidopsis* [9] and targeted transgene integration in tobacco [10] using zinc finger

nuclease-mediated double stranded break formation have been demonstrated. In addition, endogenous gene correction frequencies up to 18% have been observed in human cell cultures following zinc finger nuclease-mediated gene targeting [11].

In the present study, a target construct, comprising zinc finger nuclease binding sites and a non-functional partial selectable marker gene, was stably integrated into tobacco cell cultures. Efficient gene targeting was demonstrated through the correction of the selectable marker gene following the co-transformation with a zinc finger nuclease gene and donor DNA comprising sequences capable of complementing the non-functional marker gene and homologous to the integrated target construct.

Materials and Methods

Vectors

The following four vectors were designed and constructed in this study:

Target vector

The target construct contains the following five components as shown in **Figure 1A**: i) a hygromycin phosphotransferase (HPT) expression cassette comprising an *A. thaliana* ubiquitin-3 (ubi-3) promoter [12] driving the *E. coli* HPT gene [13] terminated by an *A. tumefaciens* open reading frame-24 (orf-24) 3' untranslated region (UTR) [14]; ii) homologous sequence-1 (Homo 1), consisting of the *N. tabacum* RB7 matrix attachment region (MAR) [15]; iii) a β -glucuronidase (GUS) expression cassette containing a Cassava Vein Mosaic Virus (CsVMV) promoter [16] driving a GUS gene [17] terminated by the *A. tumefaciens* nopaline synthase (nos) 3'UTR [18]; iv) homologous sequence-2 (Homo 2), consisting of *A. thaliana* 4-coumaroyl-oA synthase (4-CoAS) intron-1 (Locus At3g21320, GenBank NC 003074) and; v) a *S. viridochromogenes* phosphinothricin phosphotransferase (PAT) [19] 3' 256 bp partial gene fragment terminated by *A. tumefaciens* ORF-25/26 3' UTR [14]. Two types of zinc finger binding sites, BS-1 and BS-2, were integrated into the target sequence. One binding site (BS-1) was inserted downstream of the CsVMV promoter and fused with the GUS coding sequence at the N-terminal. Two copies of a second binding site (BS-2) were placed next to Homo-1 and Homo-2, respectively. The transformation vector (pTARGET) comprising the target sequence is shown in **Figure 1A**.

Donor vector

The donor DNA construct consisted of Homo 1 from the *N. tabacum* RB7 MAR [15], a full-length *A. thaliana* ubi10 promoter [12], 299bp of 5' partial PAT gene coding sequence [19] and Homo 2 from *A. thaliana* 4-CoAS intron-1 (Locus At3g21320, GenBank NC 003074). Both Homo-1 and Homo-2 in the donor vector were identical to the corresponding Homo 1 and Homo 2 in the target vector (pTARGET). The transformation vector comprising the donor sequence (pDONOR) is shown in **Figure 1B**.

¹ Dow AgroSciences, LLC, 9330 Zionsville Rd., Indianapolis, IN 46268, USA

² Sangamo BioSciences, 501 Canal Blvd., Suite A 100, Richmond, CA 94804, USA

* Corresponding author. E-mail: ccai2@dow.com

Zinc Finger Nuclease

The zinc finger-FokI fusion protein genes were driven by a CsVMV promoter and 5' UTR [16]. Also included in the cassettes were *N. tabacum* osmotin 5' and 3' UTRs [20]. A schematic representation of the ZFN-1 and ZFN-2 transformation vectors (pZFN-1 and pZFN-2) is shown in Figure 1C.

Positive Control

A vector containing an intact PAT gene expression cassette comparable with the expected homologous recombinants included the *A. thaliana* 4-CoAS intron-1 (Locus At3g21320, GenBank NC 003074) inserted at the 299/300bp of the 'complete' PAT coding sequence [19]. The resulting positive control vector (pCONTROL+) which comprised the intron-containing PAT gene driven by the *A. thaliana* ubi10 promoter and terminated by the *A. tumefaciens* orf25/26 3' UTR is shown in Figure 1D.

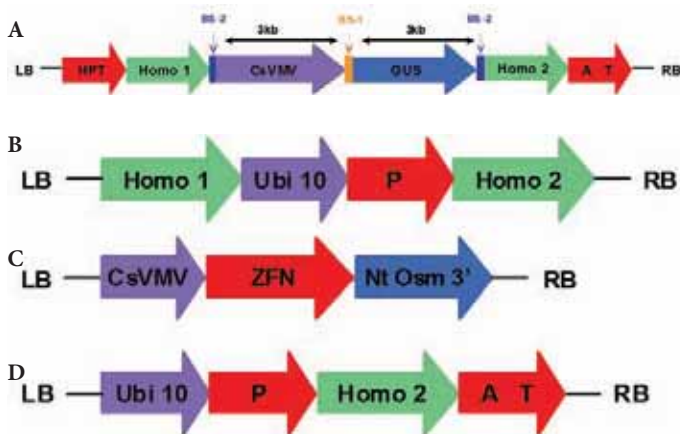

Figure 1 Schematic representation of vectors. (A) the integrated target vector pTARGET; (B) donor DNA, pDONOR; (C) zinc finger nuclease 1 (ZFN-1, pZFN-1) and 2 (ZFN-2, pZFN-2); (D) positive control pCONTROL+.

Transformation

Target Sequence Integration

BY2 tobacco cell suspension cultures were used for *Agrobacterium*-mediated transformation to stably integrate the target sequence. The BY2 cell suspension cultures were maintained in media containing LS basal salts (PhytoTechnology Labs M524), 137.4 mg/L K_2HPO_4 , 30 g/L sucrose, 2.22 mg/L 2,4-D, 1 mg/L thiamine-HCL, 100 mg/L myo-inositol and 0.5 g/L MES at a pH of 5.7. The BY2 cells were sub-cultured every seven days by adding 40 mL of fresh LS-based medium to 1 mL packed cell volume (PCV). The BY2 cell suspension culture was maintained in 250-mL flasks on a rotary shaker at 25°C and 125 RPM.

To generate transgenic BY2 cell cultures with the integrated target sequence, a four-day post sub-culture tobacco suspension was divided into 10-12 four mL aliquots which were co-cultivated in 100 x 25 mm Petri dishes with 100 μ L *Agrobacterium* strain LBA4404 harboring pTARGET grown overnight to an OD600 ~1.5. Dishes were wrapped with parafilm and incubated at 25°C without shaking for three days after which 11 mL of LS medium containing 500 mg/L carbenicillin. Following re-suspension of the tobacco cells, 1 mL suspension was dispensed onto 100 x 25 mm plates of appropriate base medium containing 500 mg/L carbenicillin and 200 mg/L hygromycin solidified with 8 g/L TC agar, and incubated unwrapped at 28°C in the dark. This resulted in 120-144 selection plates. Individual hygromycin-resistant isolates appeared 10-14 days after plating and were transferred to individual 60 x 20 mm plates (one isolate per plate) where they were maintained as callus on a 14-day subculture schedule until needed for analysis and subsequent re-transformation experiments.

Gene Targeting

A hygromycin-resistant, transgenic cell culture, BY2-380, containing a single, full-length integrated copy of the target sequence, was selected and used to re-initiate suspension cultures. *Agrobacterium*-mediated transformation of BY2-380 was performed as described above. For each experiment, 10 co-cultivation plates were generated as follows: one plate comprised cells co-cultivated with 100 μ L of an *Agrobacterium* strain harboring pDONOR (donor DNA); one plate was co-cultivated with 100 μ L of an *Agrobacterium* strain harboring pCONTROL+ (intron containing PAT selectable marker, the positive control); four plates were co-cultivated with 50 μ L of an *Agrobacterium* strain harboring pDONOR and 250 μ L of an *Agrobacterium* strain harboring pZFN-1; and four plates were co-cultivated with 50 μ L of an *Agrobacterium* strain harboring pDONOR and 250 μ L of an *Agrobacterium* strain harboring pZFN-2. Following co-cultivation, the cells were plated out on LS medium containing 500 mg/L carbenicillin and 15 mg/L Bialaphos[®]. Individual Bialaphos[®]-resistant isolates appeared 2-4 weeks after plating and were transferred to individual 60 x 20 mm plates (one isolate per plate) where they were maintained as callus on a 14-day subculture schedule until needed for analysis.

Analysis

Genomic DNA Extraction and Quantification

Genomic DNA was extracted from tobacco calli and cell suspension cultures using DNeasy 96 Plant kit (Qiagen, Valencia, CA USA) and quantified using PicoGreen ds DNA Quantitation kit (Molecular Probes, Eugene, Oregon USA). An aliquot of 2 μ L extracted genomic DNA was checked through agarose gel electrophoresis to ensure the DNA quality.

PCR and Sequence Analysis of Target and Recombinants

To confirm the full length of target sequence in the selected target lines, nested PCR was performed using Takara LA Taq polymerase (Takara, Japan). To further confirm the sequence in the selected target lines, The PCR products were cloned into pCR-Blunt II TOPO vector (Invitrogen, Carlsbad, California) and sequenced by Cogenics (Houston, Texas).

To confirm the herbicide resistance events from site-directed recombination experiments, all putative recombination events were analyzed by PCR assay initially with primer pair of TAAGGATCCAACCATGGCTTCTCC and AGATCTGGGTAAGTGGCCTAACTG. To further enhance the sensitivity of assay, a nested PCR was then performed using primer pair of TACCCTGGTTGGTTGCTGAGGTT and GAAGGCCTATAACAGCAACCACAG. To confirm if the recombination was occurred on site of target sequence rather than off site due to ectopic recombination, all events that were positive on initial PCR reaction were further analyzed through nested PCR.

The 5' end of the recombined sequence was analyzed through another set of nested PCR reactions using primer of GTGTAGAAGTACTCGCCGATAGTG) and GACGACTAGGTCACGAGAAAGCTA in the first PCR, and CCATGTTGGCAAAGGCAACCAAACandTGATAACACGACTCGTGTGTGCC in the nested PCR reaction. A subset of recombinant events were further analyzed by PCR that amplifies a DNA fragment across the entire recombined region, from the 3' end of the HPT gene to the 3' end of the PAT gene in the target sequence. This PCR analysis can eliminate the possibility that the positive PCR results in the above described reactions resulted from contamination of positive control, i.e., the intron-containing PAT expressing vector. To further confirm the sequence of the PCR products from recombinant events, the PCR fragment was purified from the gel using the QIAquick gel extraction kit (Qiagen, Valencia, CA, USA) and then either sequenced directly using the Dye terminator Cycle Sequencing Kit (Beckman Coulter) or sub-cloned into the pCR2.1 TOPO vector (Invitrogen, Carlsbad, California) then sequenced using the Dye terminator Cycle Sequencing Kit.

Results and Discussion

Production, Screening and Characterization of Target Events

A total of 224 hygromycin-resistant transgenic events were generated from BY2 suspension culture cells co-cultivated with *Agrobacterium* harboring the target sequence. Of the 123 events derived from BY2, 224 displayed GUS expression. Southern blot analysis was performed on all 123 GUS-positive isolates to determine the copy number of the integrated target sequence. Two probes representing the PAT and HPTII coding sequences were used to ensure there was no additional partial target sequence integrated into the selected event. One of the events (BY2-380) which showed GUS expression and contained a single full-length copy of the target sequence was selected for suspension culture re-establishment and subsequent re-transformation.

Gene Targeting

The two strategies deployed for zinc finger nuclease-mediated gene targeting are outlined in Figure 2. In one strategy the zinc finger binding site (BS-1) was centrally located in the target construct with ~ 3 kb of non-homologous sequence between BS-1 and the nearest homologous sequence. In the presence of ZFN-1 and donor DNA, which contained homologous sequences identical to that in the target, the 5' partial PAT gene along with its promoter, replace the entire ~ 6 kb fragment between the homologous sequences in the target through simultaneous gene replacement and addition whereby the two partial PAT gene sequences reconstitute a functional PAT gene, resulting in PAT expression and an herbicide resistance phenotype. A second strategy involved two zinc finger binding sites (BS-2) directly downstream and upstream of the left and right side homologous sequences, respectively. Between the two BS-2 sites was ~ 6 kb of DNA sequence. Expression of the ZFN-2 gene results in excision of the ~ 6 kb fragment and, in the presence of donor DNA, PAT gene correction via gene addition.

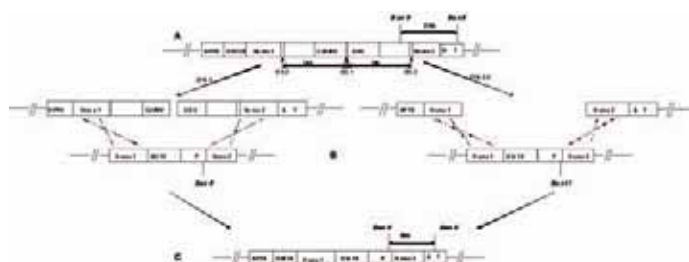

Figure 2 Predicted site directed gene replacement and addition mediated by zinc finger nucleases, ZFN-1 and ZFN-2.

Table 1. Summary of Re-transformation of Target Cell Cultures with Zinc Finger-FokI Fusion Protein Genes and Donor DNA.

Treatment	# of Selection Plates	# of Herbicide Resistant Events	Ave. # of Events per Selection Plate
Positive control (pCONTROL+, PAT gene only)	46	536	11.7
Donor DNA only (pDONOR)	46	0	0
Donor DNA + ZFP-1 (pDONOR + pZFN-1)	214	43	0.2
Donor DNA + ZFP-2 (pDONOR + pZFN-2)	214	47	0.2

Table 1 summarizes the results of retransforming target culture BY2-380 with zinc finger nuclease-containing constructs pZFN-1 and pZFN-

2. Out of 214 selection plates, 43 and 47 herbicide resistant isolates were obtained from the re-transformation with the donor DNA together with ZFN-1 and ZFN-2, respectively. When compared to the re-reformation with the positive control, the intron-contained PAT gene, the frequency of recombinants was 1.7% for both ZFN-1 and ZFN-2. No herbicide resistant isolates were obtained from the re-transformation with the donor DNA only.

All putative recombination events obtained following herbicide (Bialaphos[®]) selection were first analyzed by PCR using primers specifically for amplifying a DNA fragment spanning the re-constituted PAT gene, more specifically, the forward primer anchored to the 5' end of the PAT coding sequence in the donor DNA and the reverse primer anchored to the 3' end of the PAT coding sequence in the target DNA. A 2.3kb PCR fragment would be obtained only if the two partial PAT coding sequences were joined together through recombination. Figure 3 shows the PCR results from a set of 20 isolates selected from the co-transformation of BY2-380 target line with ZFN-1 or ZFN-2 gene along with donor DNA. As predicted, a 2.3kb PCR product was obtained from all of these isolates selected (**Figure 3A-I**). The 2.3kb PCR product from multiple independent isolates representing those derived from both ZFN-1 and ZFN-2 transformations were purified from agarose gels, cloned into the pCR2.1 TOPO vector, and then sequenced. The sequencing results confirmed that all of the PCR products cloned in the TOPO vector contained the recombined sequence as predicted, including the 5' and 3' partial PAT gene sequences with the intervening 4-CoAS intron-1. This result confirmed the predicted recombination for both strategies tested and exemplified gene targeting via zinc finger nuclease gene expression.

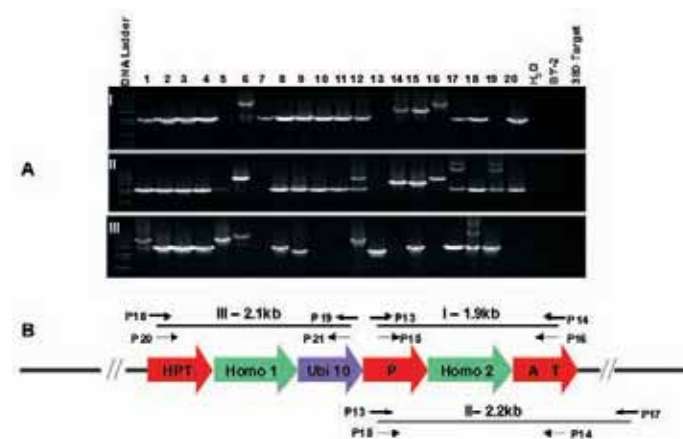

Figure 3 PCR confirmation of inter-chromosomal recombination events from BY2-380 target line. 1-16: recombinants derived from ZFN-2 treatment, 17-20: recombinants derived from ZFN-1 treatment. (A) PCR amplification of recombinants: I. 3' of predicted recombinants from 5' partial PAT to 3' partial PAT gene. II. 3' of predicted recombinants from 5' partial PAT to the flanking genomic sequence at 3' end. III. 5' of predicted recombinants from HPT to 5' partial PAT gene. (B) Predicted recombinants.

To further characterize the putative recombination events, two additional nested PCR reactions that allowed for a detailed analysis of the recombinant sequences were carried out (**Figure 3B**). In the four samples generated from co-transformation with ZFN-1 and donor DNA, two of the samples displayed amplification of the expected size fragment in all three reactions (lanes 17 and 18). The other samples displayed no amplification in one of the three PCR reactions. Of the 16 samples generated from co-transformation with ZFN-2 and pDONOR, five amplified the expected size fragment in all three reactions (lanes 2, 3, 4, 9 and 15). Six of the samples displayed amplification of the expected size fragment in the PCR reactions associated with the corrected PAT gene sequence. In one of the samples only the 5' reaction resulted in the expected size

fragment (lane 13). The remaining samples had either no amplification or altered size in at least one of the reactions. Thus, among this set of 20 Bialaphos[®]-resistant isolates 7 of the 20 samples gave results consistent with high fidelity recombination across the entire integrated sequence.

Conclusion

Zinc finger-mediated gene targeting was achieved in tobacco cells. This conclusion is based on the fact that functional herbicide resistance was observed following re-transformation of target events (containing a partial 3' PAT gene) with donor DNA (containing the corresponding 5' PAT gene sequence) and PCR amplification of expected recombinant fragments was demonstrated. In addition, sequence analysis of PCR products confirmed recombination.

Zinc finger nuclease expression stimulates homology-driven repair in a large region surrounding a double strand break in tobacco suspension cells (~3kb on each side). This conclusion is based on the simultaneous gene replacement and addition strategy employed with ZFN-1.

Imperfect recombination apparently resulting from non-homologous DNA repair was also observed.

BIBLIOGRAPHY

1. Iida, S., And Terada, R. Modification of endogenous natural genes by gene targeting in rice and other higher plants. *Plant Mol Biol.* **59**, 205-219 (2005).
2. Terada, R., Urawa, H., Inagaki, Y, Tsugane, K., Iida, S. Efficient gene targeting by homologous recombination in rice. *Nature Biotech.* **20**, 1030-1034 (2002).
3. Shaked, H., Melamed-Bessudo, C., Levy, A.A. High-frequency gene targeting in Arabidopsis plants expressing the yeast RAD54 gene. *Proc. Nat. Acad. Sci. USA* **102**(34), 12265-12269 (2005).
4. Puchta, H. The repair of double-strand breaks in plants: mechanisms and consequences for genome evolution. *J. Experimental Botany* **56**(409), 1-14 (2005).
5. Porteus, M.H., Carroll, D. Gene targeting using zinc finger nucleases. *Nature Biotechnology* **23**(8), 967-973.
6. Puchta, H., Dujon, B., Hohn, B. Homologous recombination in plant cells is enhanced by *in vivo* induction of double strand breaks into DNA by a site-specific endonuclease. *Nucleic Acids Research* **21**(22), 5034-5040 (1993).
7. Bibikova, M., Carroll, D, Segal, D.J., Trautman, J.K., Smith, J., Kim, Y., Chandrasegaran, S. Stimulation of homologous recombination through targeted cleavage by chimeric nucleases. *Mol. Cell. Biol.* **21**, 289-297 (2001).
8. Porteus, M.H., Baltimore, D. Chimeric nucleases stimulate gene targeting in human cells. *Science* **300**, 763 (2003).
9. Lloyd, A., Plaisier, C.L., Carroll, D., Drews, G.N. Targeted mutagenesis using zinc-finger nucleases in *Arabidopsis*. *Proc. Nat. Acad. Sci. USA* **102**(6), 2232-2237 (2005).
10. Wright, D., Townsend, J.A., Winfrey Jr, R.J., Irwin, P.A., Rajagopal, J., Lonosky, P.M., Hall, B.D., Jondle, M.D., Voytas, D.F. High-frequency homologous recombination in plants mediated by zinc-finger nucleases. *The Plant Journal* **44**, 693-705 (2005).
11. Urnov, F.D., Miller, J.C., Lee, Y., Beausejour, C.M., Rock, J.M., Augustus, S., Jamieson, A.C., Porteus, M.H., Gregory, P.D., Holmes, M.C. Highly efficient endogenous human gene correction using designed zinc-finger nucleases. *Nature* **435**, 646-651 (2005).
12. Callis, J., Raasch, J.A., And Vierstra, R.D. Ubiquitin Extension Proteins of *Arabidopsis thaliana*. *J. Biol. Chem.* **265**(21), 12486-12493 (1990).
13. Walters, D.A., Vetsch, C.S., Potts, D.E., And Lundquist, R.L. Transformation and inheritance of a hygromycin phosphotransferase gene in maize plants. *Plant Mol Biol.* **18**, 189-200 (1992).
14. Gelvin, S.G., TR-based sub-Ti-plasmids. *EP Patent 222493* (1987).
15. Thompson, W.F., Hall, G., Spiker, S., Allen, G.C. A plant nuclear scaffold attachment region which increases gene expression. *WO Patent 97/27207* (1997).
16. Verdaguer, B., Kochko, A.D., Beachy, R.N., Fauquet, C. Isolation and expression in transgenic tobacco and rice plants, of the cassava vein mosaic virus (CVMV) promoter. *Plant Mol Biol.* **31**, 1129-1139 (1996).
17. Jefferson, R. Assaying chimeric genes in plants: the GUS gene fusion system. *Plant Mol Biol Rep.* **5**(4), 387-405 (1987).
18. Depicker, A., Stachel, S., Dhaese, P., Zambryski, P., Goodman, H.M., Nopalinesynthase: transcript mapping and DNA sequence. *J. Mol Appl. Genet.* **1**(6), 561-573 (1982).
19. Wohlleben, W., Arnold, W., Broer, I., Hillemann, D., Strauch, E., Puhler, A. Nucleotide sequence of the phosphinothricin N-acetyltransferase gene from *Streptomyces viridochromogenes* Tu494 and its expression in *Nicotiana tabacum*. *Gene* **70**, 25-37 (1998).
20. Merlo, D.J., Liu, D., Burton, S.L., Glancy, T.P. Use of untranslated region of osmotin gene to enhance transgene expression in plants. *US Patent 2005/0102713* (2005).

Genetically Unstable Mutants as Novel Sources of Genetic Variability: The Chloroplast Mutator Genotype in Barley as a Tool for Exploring the Plastid Genome

A R Prina*, A M Landau, N Colombo, M Jaureguiualzo, M C Arias, R D Rios & M G Pacheco

Abstract

The presence of clonally variegated seedlings was used as a criterion to isolate putative genetically unstable mutants (GUMs) from the M_2 or further generations arising from X-rays and/or chemical treatments applied to barley seeds. Analysis of seedlings in the glasshouse revealed that in some of the families isolated, a particular spectrum of mutant phenotypes was repeatedly observed over several generations of auto pollination. By reciprocal crosses it was noticed that some of these GUMs produced maternally-inherited changes and they were classified in two groups manifesting either a narrow or a wide spectrum of mutant phenotypes. One case of the latter, designated as a “chloroplast mutator” genotype, has been studied in our Institute since 1985. In several mutants obtained from this GUM, evidence of major plastid-DNA changes were not detected, but interestingly, sequencing of some plastid genes showed that single nucleotide mutations were present. Mutational changes, consisting in transitions T/A – C/G which were located at three different positions in the plastid gene *infA*, were detected in three independently-originated *albo-viridis* mutants. Additionally, one transition and one base insertion on the *ycf3* locus were observed in a temperature-sensitive *viridis* type and one transition on the plastid gene *psbA* was observed in families selected for atrazine tolerance. Both the wide spectrum of mutants and the subtle DNA changes induced in this barley chloroplast mutator genotype, suggest that it can be an exceptionally valuable tool to explore the potential functionality of the otherwise highly conserved plastid genome.

Introduction

Induced mutation techniques have contributed impressive amounts of genetic variability to plant research and plant breeding. For the most-part, variability has been observed in nuclear genes, while little progress has been made in the induction of variability in genes of the plastid and mitochondria. Looking for novel sources of genetic variability that could fill this gap, we isolated several putative genetically unstable mutant (GUM) families originating from diverse X-ray and/or chemical treatments applied to barley seeds. Selection was based on the presence of clonally variegated seedlings (*striata* type) in M_2 -spike progenies or in plant progenies of further generations. Seedling analysis carried out in the glasshouse over several generations of autopollination revealed that in some of the families isolated, a particular spectrum of mutant phenotypes was repeatedly observed, suggesting that some parts of the genome were differentially affected depending on the different GUMs. Reciprocal crosses and glasshouse screening allowed the detection of cytoplasmically inherited mutations in some of these GUMs, which could be clearly classified into two groups according to whether they induced either a narrow or a wide spectrum of mutant phenotypes, as previously proposed [1]. GUMs belonging to the last group seem to

be more interesting to use as new sources of genetic variability. To our knowledge, this kind of experimental material has been reported several times in dicot species, but there is only one example in monocots [2]. So far, we have isolated only two GUMs of this type. In this paper we summarize results from molecular analyses of mutants isolated from one of them, previously reported as the barley “chloroplast mutator” genotype [2].

Results

The barley chloroplast mutator genotype and the isolation of genetically stable chlorophyll deficient types
The barley chloroplast mutator genotype was previously described as a nuclear gene that when homozygous, induces several types of cytoplasmically inherited chlorophyll deficiencies [2]. It was postulated that the nuclear genotype responsible for the recurrent occurrence of plastome mutants was probably related to failures in a DNA-repair mechanism [2]. It was observed that homozygous mutator plants had a normal vigor phenotype, that the expression of the mutator activity was limited to a low percentage of F_2 -seedlings from crosses using mutator plants as male parent and the phenotype was only manifested as narrow isolated streaks [2]. Chlorophyll-deficient types were mostly observed as clonally variegated plants, but in the F_3 and the F_4 some solid phenotypes were also observed at second-leaf seedling stage. In order to obtain genetically stable families, some of the chlorophyll mutants that were viable at the field nursery were backcrossed as female to wild type plants. Later on, selection of stable families was carried out in the F_3 and further generations. The first four genetically stable families showed particular chlorophyll deficient types and also differed in their genetic instability. They were designated as cytoplasmic lines (CLs) and a basic description was published [3].

No structural changes in plastid DNA were detected in four chloroplast mutator induced CLs

Extensive RFLP analysis showed no differences in the restriction patterns of CL1, CL2, CL3 and CL4 compared to the control genotype, suggesting that the barley chloroplast mutator did not induce major changes in plastid DNA [4].

Three different transitions on the *infA* plastid gene

CL2 is a chlorophyll deficient *albo-viridis* type that has a time-dependent phenotype mainly restricted to the upper part of the first leaf blade [3] and shows a pattern of greening and plastid development opposite to that usually observed in monocots [5]. Results from experiments in which embryogenesis occurred at different temperatures and with seeds with or without antibiotic treatments, indicated that CL2 syndrome produces a delay in plastid protein synthesis during embryogenesis and on this basis, the *infA* gene was proposed to be responsible for that syndrome [5]. This gene encodes a protein that is homologous to the bacterial translation initiation factor 1 (IF1) [6]. This is a highly conserved protein that belongs to the family of oligonucleotide binding fold

Instituto de Genética Ewald A. Favret- CICVyA-INTA. Castelar, Buenos Aires, Argentina

* Corresponding author. E-mail: aprina@cnia.inta.gov.ar

proteins, to which ribosomal protein S1 and the cold shock proteins CspA and CspB also belong [7]. The comparison of *infA* gene sequences found in wild type or CL2 seedlings showed a mutational change, it was a T→C transition at nucleotide 157 (GenBank AY488513), corresponding to a semi-conserved amino acid change of serine to proline at residue 52, which is a highly conserved residue of the IF1 protein in Poales [8]. Fifteen other CL2-like isolates from the same chloroplast mutator pool presented an identical mutation. However, on new pools made by crossing the mutator genotype as a male parent, two new CL2-like mutants showing maternal inheritance were isolated. One of these new mutants showed a T→C substitution at nucleotide 97 (GenBank AY743911), giving a conserved amino acid change from phenylalanine to leucine at the universally conserved residue 32 of the IF1 protein [8]. The third point mutation in the *infA* gene was recently identified (A.M. Landau and A.R. Prina, unpublished); it is an A→G transition at position 185 and it also corresponds to a highly conserved residue of the IF1 protein. To our knowledge, these three mutants carrying the CL2 syndrome are the first detected in the *infA* gene of higher plants and consequently, they can greatly contribute to the understanding of the functions of this plastid gene that are at present inferred from information in bacteria.

A transition and one-base insertion in *ycf3* locus

For CL3, a homogeneous light green (*viridis*) type [3] that is very sensitive to high temperature [9], *ycf3* and *ycf4* plastid loci, each encoding a different PSI-assembly chaperone, were postulated as candidate genes. In CL3 and in the wild type the sequences of *ycf4* were the same, while, in the *ycf3* locus two differences were found, a transition (T→C) at position 528 and a base insertion (T) at position 150. Both changes were localized in one of the two introns of the *ycf3* locus, intron 1, which interestingly resulted in a temperature-sensitive defective splicing (A.M. Landau, unpublished).

A transition on *psbA* gene

In order to test the generation of inheritable changes in traits other than chlorophyll deficiencies, we used selection experiments with atrazine as a model, due to the well-understood molecular basis of this character. Two atrazine-tolerant families were obtained after two generations of selection applied on a pool of mutator plants [10]. Molecular characterization was performed by PCR amplification of an internal fragment of the plastid gene *psbA*. The *BstXI* restriction pattern of the amplified fragments showed one band in the wild-type, but two in atrazine-tolerant plants. Sequence analysis of a 277 bp fragment showed a transition (A→G) at position 790 of the *psbA* gene, which created a *BstXI* restriction site, and corresponds to an amino acidic change of serine-to-glycine in the D1 protein of PS II. This result was in agreement with the molecular basis previously described for other atrazine-tolerant plants, such as rapeseed and several weed species [10]. As the two identical tolerant families were isolated from the same pool of plants carrying the mutator genotype it is not possible to determine the independence of the mutational events originating them.

Discussion and Conclusions

Based on more than 20 years of glasshouse and field observations in progenies from autopolllination, reciprocal crosses and backcrosses, we can conclude that the barley chloroplast mutator genotype induces a wide spectrum of mutants with cytoplasmic inheritance, including several viable and normal vigor types. Homozygous mutator plants show a normal vigor phenotype, suggesting that no massive disturbances are induced by the mutator action [2]. The lack of major plastid DNA changes in CLs and the point mutations observed in plastid genes, suggest that the barley mutator genotype presented here is an important source of genetic variability allowing the induction of mutant alleles with remaining functionality. This enables the induction of allelic series,

instead of gene knockouts, for the highly conserved plastid genes. This is exemplified by the induction of the three different viable *infA* gene mutants mentioned above, the first ones reported in higher plants [8].

It is important to state here that most of the mutants we isolated from the barley chloroplast mutator genotype were selected from a single pool of plants maintained for several generations by autopolllination. The isolation of 15 CL2-like mutants carrying identical *infA* gene sequences from that pool of plants, alerted us to the necessity of handling the plant material in a more controlled manner, in order to avoid duplications of mutants arisen from the same mutational event [8]. This is especially important for plastome mutants in higher plants for which the allelic tests used for nuclear genes are not available.

It must be remarked that the exploration of the plastid genome by postulating and sequencing candidate genes, as we have been doing so far, is limited to those genes that can be inferred from a particular mutant phenotype, or by using certain artificial selective pressures. During the last few years, the TILLING strategy (Targeting Induced Local Lesions in Genomes), which combines chemical mutagenesis with a powerful screening methodology [11, 12], has made allelic series of nuclear genes available and has become a powerful method for elucidating the function of nuclear genes in higher plants. In this context, the impact of the barley mutator genotype as a tool for exploring the plastid genome can be dramatically improved by developing a TILLING strategy targeted to the plastome.

BIBLIOGRAPHY

1. Kirk, J.T.O., Tilney-Basset, R.A.E. The plastids. Elsevier, North Holland, Amsterdam (1978).
2. Prina, A.R. A mutator nuclear gene inducing a wide spectrum of cytoplasmically - inherited chlorophyll deficiencies in barley. *Theor. Appl. Genet.* **85**, 245-251. (1992).
3. Prina, A.R. Mutator-induced cytoplasmic mutants in barley. Genetic evidence of activation of a putative chloroplast transposon. *J. Hered.* **87**(5), 385-389 (1996).
4. Colombo, N. *et al.* Plastome analysis of barley chloroplast mutator-induced mutants. *Basic Appl. Genet.* **17**(1), 5-9 (2006).
5. Prina, A.R. *et al.* A cytoplasmically inherited mutant controlling early chloroplast development in barley seedlings. *Theor. Appl. Genet.* **107**, 1410-1418 (2003).
6. Millen, R.S. *et al.* Many parallel losses of *infA* from chloroplast DNA during angiosperm evolution with multiple independent transfers to the nucleus. *Plant Cell* **13**, 645-658 (2001).
7. Laursen, B.S. *et al.* Initiation of protein synthesis in bacteria. *Microbiol. Mol. Biol. Rev.* **69**, 101-123 (2005).
8. Landau, A. *et al.* Two *infA* gene mutations independently originated from a mutator genotype in barley. *J. Hered.* **98**(3), 272-276 (2007).
9. Martínez, A.E. *et al.* Two mutants affecting adaptive responses to abiotic stresses in barley seedlings. *Czech J. Genet. Plant Breed.* **41**(1), 1-10 (2005).
10. Rios, R.D. *et al.* Isolation and molecular characterization of atrazine tolerant barley mutants. *Theor. Appl. Genet.* **106**(4), 696-702 (2003).
11. McCallum, C.M. *et al.* Targeting Induced Local Lesions In Genomes (TILLING) for Plant Functional Genomics. *Plant Physiol.* **123**, 439-442 (2000).
12. Till, B.J. *et al.* Discovery of chemically induced mutations in rice by TILLING. *BMC Plant Biol.* **7**, 19 (2007).

Mutagenesis of Genes for Starch Debranching Enzyme Isoforms in Pea by Zinc-Finger Endonucleases

H Hussain

Abstract

Starch debranching enzymes in plants are divided into two groups based on their ability to hydrolyze different substrates. The first group, pullulanases, hydrolyze α -1,6-glucosidic linkages in substrates such as pullulan, amylopectin and glycogen. The second group of debranching enzymes, isoamylases, hydrolyze glycogen and amylopectin and are not active on pullulan. Three isoforms of isoamylase and a pullulanase have been isolated from a cDNA library of *Pisum sativum*. These isoamylases have been characterized following their heterologous expression in *E. coli*. Based on the DNA sequence that encodes these debranching enzymes, a specific mutagenesis targeting these enzymes will be attempted. The technique involves the homologous recombination of DNA mediated by zinc-finger endonucleases. Vectors will be constructed to include a fragment that will modify these genes. Using this technique, it is hoped that null mutants for each enzyme will be created and the exact role of these enzymes for the synthesis and degradation of starch in plants will be elucidated.

Introduction

Synthesis of starch involves several major enzymes such as ADP-glucose pyrophosphorylase (AGPase), starch synthases (soluble and granule bound), starch branching enzymes (SBE) and starch debranching enzymes (DBE). Of the four main enzymes, the isoforms of starch DBE are the least described in terms of their exact role in the process of starch biosynthesis. Starch DBE can be divided into two major groups, namely isoamylases and pullulanases. The differences between these two groups are in their ability to hydrolyze different type of starch substrates. The isoamylases hydrolyze glycogen and amylopectin and are not active on pullulan. Genes encoding three different isoforms of isoamylases have been characterized in potato [1]. In addition, to the isoamylase isoforms from potato, similar isoforms from wheat have also been described [2]. These isoforms showed different catalytic properties towards starch substrates. The pullulanases hydrolyze α -1,6-glucosidic linkages in substrates such as pullulan, amylopectin and glycogen. Genes encoding pullulanases have also been described in several plants [2, 3]. This paper describes the identification of starch DBE from pea, including isoamylase isoforms and pullulanase. The data can be used for further characterization of starch biosynthesis in plants, such as using the gene sequence to produce null mutants. Mutational studies of pullulanase in *Zea mays* have been described [3]. However, no studies report the effects of mutagenesis of isoamylase isoforms and pullulanase on starch formation.

There are several techniques for mutagenesis of plants, such as TILLING methods, ion-beam implantation, and *in planta* transformation methods using *Agrobacterium*. Another method of plant mutagenesis is by homologous recombination of the targeted gene using zinc-

finger endonucleases or zinc finger nucleases (ZFN). In this method, a specific gene can be targeted for mutation *in situ* leaving the rest of the genome unperturbed. This strategy has several advantages over gene addition procedures, which include the risk of mutations arising from random insertion, because the approach aims to incorporate exogenous DNA at a predetermined site in the chromosome. In addition, the exogenous DNA does not have to include a complete protein coding sequence or separate signals to ensure its expression because it is incorporated at an endogenous locus. Inappropriate tissue specificity, timing, level and duration of expression are not issues, because the targeted gene remains under normal, endogenous controls [4]. Thus, if targeted mutation can be accomplished with high efficiency, other genetic factors affecting the mutant can be ruled out. Therefore, based on the identification of starch DBE from pea as described here, we propose to develop a series of mutant plants harbouring frame-shift mutations (knockout mutants) for the starch DBE in pea.

Methodology

Methodology for identification of isoforms of isoamylase and pullulanase followed the methods that have been described previously [1]. They can be outlined as follows:

- Design of degenerate primers for isoamylase isoforms and pullulanase based on the sequences of these enzymes from other plant species that can be obtained from available databases.
- PCR of coding regions of isoamylase isoforms and pullulanase with degenerate primers.
- Screening of a pea embryo cDNA library using fragments obtained using the PCR described above.
- *In silico* characterization of nucleotide sequences including sequence alignments and structural determination.
- Heterologous expression of DBE genes in *E. coli* for enzyme analysis.
- Dinitro-salicylic acid (DNS) assay to determine debranching activities of isoamylase.

For the mutagenesis work, the methodology that is going to be employed will be based on the work described by Wright and co-workers [5]. The work is summarized as follows:

- Identify ZFNs target sites near the targeted locus within the gene of interest.
- Design and select zinc finger proteins (ZFPs) that recognize the chosen ZFN target sites.
- Convert the designed and/or selected ZFPs into ZFNs.
- Deliver ZFNs alone to induce a targeted double strand break (DSB) in starch DBE genes of normal cells and stimulate non-homologous end-joining to generate a pool of mutants, some of which will be frame-shift mutations resulting in functional deletion of DBE gene, i.e. knock-outs of DBE genes.
- Monitor for gene correction (or reverse mutagenesis) at the targeted gene loci using appropriate PCR techniques.

Department of Molecular Biology, Faculty of Resource Science and Technology, Universiti Malaysia Sarawak, 94300 Kota Samarahan, Sarawak Malaysia

E-mail: hhasnain@frst.unimas.my

- Monitor the resulting mutants so that the mutated fragment does not integrate elsewhere within the genome of the cell by appropriate PCR and hybridization techniques.

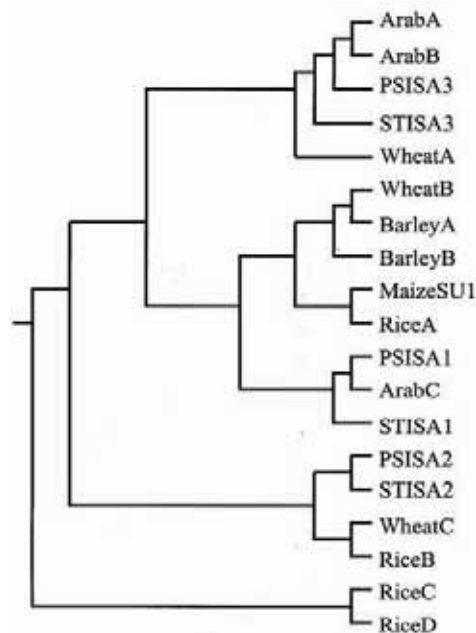

Figure 1 Phylogenetic tree of predicted amino acid sequences of isoamylase proteins from pea (PSISA1, PSISA2 and PSISA3) and other plants.

non-active isoamylase isoforms might play a non-catalytic role during the formation or degradation of starch. *In silico* characterization of the pea pullanase showed that the translated amino acid sequence of this gene was similar to pullulanases isolated from other plants and bacteria. The amino acids sequence also suggested that the gene encoded a plastidial form of pullulanase similar to that found in spinach and rice. These results can be used to design oligonucleotides that can be used in gene targeting studies.

The ZFC-mediated gene mutagenesis is rapidly becoming a powerful and versatile tool for targeted genome engineering of many different organisms and cells, including plant and human cells. Previous studies of gene targeting using ZFN has shown successful application. Since data from the *in silico* characterization of isoforms of isoamylase and pullulanase showed the complete sequence of the pea genes, the process of producing ZFNs to induce double strand break is likely to be successful.

Conclusion

The screening of a pea cDNA library for gene sequences of starch debranching enzymes indicated the existence three different isoforms of isoamylase and one isoform of pullulanase. This is similar to results obtained for potato [1]. Further investigation of the exact roles of these enzymes in starch biosynthesis can be undertaken by null mutation, employing ZFN-technology. Gene targeting offers great promise for studying the functions of various genes through reverse genetics, which is sometimes difficult to achieve using other methods. It is hoped that the mutagenesis study can reveal more details of exact role of starch DBE in the synthesis and degradation of starch in plants.

ACKNOWLEDGEMENTS

The author wishes to thank IAEA and University Malaysia Sarawak for awarding grants to attend the symposium. Also, special thanks to Cathie Martin (John Innes Centre, UK) for her help with the work.

BIBLIOGRAPHY

1. Hussain H., Mant A., Seale R., Zeeman S., Hinchliffe E., Edwards A., Hylton C., Bornemann S., Smith A.M., Martin C., Bustos R. Three isoforms of isoamylase contribute different catalytic properties for the debranching of potato glucans. *Plant Cell* **15**, 133-149 (2003).
2. Genschel U., Abel G., Lorz H., Lutticke S. The sugary-type isoamylase in wheat: tissue distribution and subcellular localization. *Planta* **214**, 813-820 (2002).
3. Dinges J.R., Colleoni C., James M.G., Myers A.M. Mutational Analysis of the Pullulanase-Type Debranching Enzyme of Maize Indicates Multiple Functions in Starch Metabolism. *Plant Cell* **15**, 666-680 (2003).
4. Porteus M.H., Carroll D. Gene targeting using zinc finger nuclease. *Nature Biotech.* **23**, 967 - 973 (2005).
5. Wright D.A., Townsend J.A., Winfrey Jr R.J., Irwin P.A., Rajagopal J., Lonosky P.M., Hall B.D., Jondle M.D., Voytas D.F. High-frequency homologous recombination in plants mediated by zinc-finger nucleases. *Plant J.* **44**, 693-705 (2005).

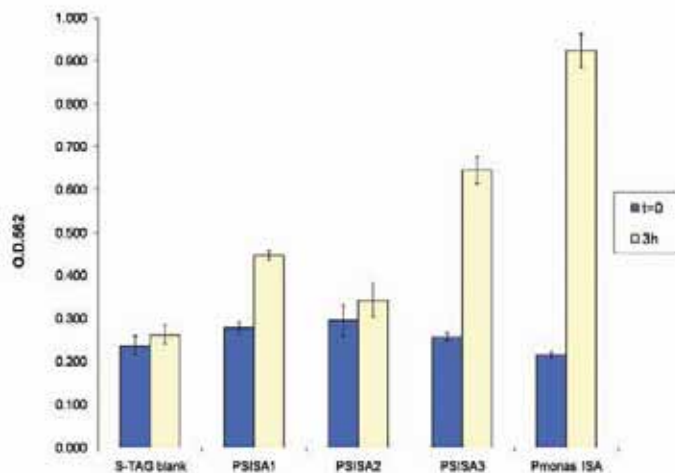

Figure 2 Debranching activities of pea isoforms of isoamylase expressed in *E. coli* tested using the DNS assay. PSISA1 and PSISA3 show the presence of activity, while PSISA2 did not show any significant difference to the control.

Results and Discussion

Comprehensive screening of a pea embryo cDNA library has shown that there are three different genes that encode isoamylases in pea (Fig. 1). Analyses of the primary structure of these isoamylase isoforms showed that two of them are most likely to have catalytic activity. However, one of the isoform, PSISA2 is unlikely to have the catalytic activity. This was further confirmed by the DNS assay using amylopectin as a substrate (Fig. 2). *In silico* analysis of the PSISA2 isoform also showed that it retained the characteristics to bind to glucans. Therefore, it is likely that

Generation of New Rice Cultivars from Mature Pollen Treated with Gamma-Radiation

H Wang, S Qiu, J Zheng, L Jiang, H Huang & Y Huang*

Abstract

Two new high-quality and early-yielding *indica* rice cultivars, Jiahezaozhan and Jiafuzhan, have been developed, certified, and cultivated by farmers in the provinces of Southern China. These new rice varieties were created by a new mutation breeding technique in which mature rice pollen irradiated with Gamma (γ)-ray was used to produce parents for crossing. The optimal dose for the irradiation was approximately 46Gy. The cumulative effects of the mutations increased in advanced generations and most of the mutant traits became stable in the fifth generation. These results showed that the mutations generated by Gamma- radiation on mature rice pollen were largely of quantitative trait loci.

Key Words:

Rice (*O. sativa* L. *indica*);Mature pollen; γ -ray irradiation;Mutation breeding

Introduction

The creation of new germplasm resources, such as dwarf, cytoplasm male sterile (CMS) and photo-thermo-period sensitive genic male sterile (PTGMS) rice derived from natural mutations, has brought significant changes to rice breeding and production in China [1]. In contrast, few human-assisted (induced) mutations have resulted in the development of new plant varieties, despite ample demonstration that the various mutation techniques can induce mutation and create new genotypes for the generation of novel germplasm by mutation breeding [2].

We have used Gamma-radiation of mature rice pollen to generate mutants with novel traits. When the haploid rice pollen is irradiated by Gamma-rays, there are different degrees of damage to the male gametes in the pollen and the induced mutation has no chimerism. However, the traits exhibited by progenies generated from the fusion of male gametes and eggs are variable. Our data demonstrates that the mutant traits of progenies generated using this technique are inheritable. This technique has been exploited to generate new plant varieties. The high-quality early *indica* rice cultivars, Jiahezaozhan and Jiafuzhan, were developed by the combination of this mutation technology and sexual hybridization. Our data is consistent with previous findings that irradiation of rice mature pollen with Gamma-rays can produce a wide mutation spectrum of progenies [3], but contradicts the argument that the rice pollen was more resistant to irradiation and that the variation of traits in the second-generation was similar to that produced by conventional hybridization [4, 5].

Materials and Methods

Rice varieties: Rice varieties, Ma 85 and Bai 85 (*Oryza sativa* L. *indica*), were obtained from the Rice Research Institute of Fujian Academy of Agricultural Sciences, China (FJRRRI). They are genetically stable, resist-

ant to blast, and have a seed set rate of more than 90%. The grain was short and elliptical in shape and basically impossible to thresh.

Radiation source: The ^{60}Co radiation facility at FJRRRI was used for the experiments.

Irradiation method: Spikes were collected in the proper time, placed in a glass Petri dish, and irradiated with Gamma-rays in doses of 0, 23, 46, 93, and 186Gy. The Petri dish maintains a moist environment, such that the floral glume of the rice spike can blossom and expose itself to others without dispersing the pollen. This method is practical and repeatable, and the pollen is still viable one to two hours after the radiation treatment.

Pollination and observation: Seeds were cut in half after a hot-water-emasculatation treatment, pollinated with mature rice pollen irradiated by Gamma-rays, and placed in dark envelopes until maturity. First-generation hybrid seeds (H_1) were cultivated from a single plant. Each individual plant was harvested. Second-generation hybrid seeds (H_2) were grown from a single plant from each line of 60 plants. From the third-generation (H_3) on, every generation was also cultivated from a single plant of each line. Plants in each generation and group were observed closely for their height, heading stage, seed setting rate and grain shape.

Results and Discussion

Establishment of sexual hybridization technology for rice mature pollen irradiated by Gamma-rays

The life span of rice pollen is only a few minutes. In order to treat the mature rice pollen with Gamma-radiation, whole plants were used. Irradiation of cultured spikes stripped from tillers and kept with wet tissue was not effective, as it was difficult to locate the pollen and keep it viable. However, over the past years, we have successfully performed hundreds of radiation treatments by preserving the spikes in Petri dishes. This overcomes the technological bottleneck of Gamma-radiation treatment of the mature rice pollen and is routinely applied in our research.

Table 1. Mutant traits in H_1 plants derived from mature pollen irradiated by different Gamma-ray doses.

Dose (Gy)	No. of individuals	Plant height (cm)	Heading stage (day)		Seed setting rate (%)
			Ahead of time	Postponed	
0	50	95-110	0	0	90
23	150	80-110	0	0	20-90
46	200	80-110	0	1-3	10-90
93	200	70-110	0	1-5	50-90
186	100	70-105	0	1-10	0.5-10

Mutant trait performance of H_1 plants derived from mature pollen treated with Gamma-radiation

Original plants of Ma 85 and Bai 85, with their glumes cut in half after a hot-water-emasculatation treatment, were pollinated with mature rice

School of Life Sciences, Xiamen University, Xiamen, Fujian 361005, China

* Corresponding author. E-mail: hym@xmu.edu.cn

pollen irradiated by Gamma-rays, and placed in dark envelopes until maturity. The H₁ was cultivated from a single plant and the plant height, heading stage and seed setting rate were recorded (Table 1).

The results showed that increasing radiation doses increased detrimental phenotypes in H₁ plants. The H₁ population traits showed no obvious difference to the control group, except a slight decrease of seed setting rate, when the radiation dose was 23Gy. However, with more than 46Gy dose, there were distinct inhibitory effects on the plant height, heading stage and seed setting rate of the H₁ population. However, for each treatment, the degree of inhibition differed between individual plants. It was obvious that the induced mutation of rice mature pollen irradiated by Gamma-rays was random.

Mutant trait variation of H₂ plants derived from mature pollen treated with Gamma-radiation

Because of different seed setting rates, each H₁ plant was harvested separately. Each H₂ plant was cultivated from single lines of 60 entries. Then, the variation of plant height, heading stage and seed setting rate of the H₂ population was recorded (Table 2). The results indicated that the H₂ generated from pollen exposed to radiation over 46Gy had two-way variation in plant height and heading stage. The variation was much greater than in mutagenesis experiments performed with dry seeds.

Table 2. Variation frequency of mutant traits in H₂ plants derived from mature pollen irradiated by different Gamma-ray doses.

Dose (Gy)	No. of individuals	Variation frequency of plant height (%)		Variation frequency of heading stage(%)		Variation frequency of seed setting rate(%)	
		Dwarf	Tall	Early	Later	<50%	50-85%
0	500	0	0	0	0	0	0
23	500	3.1	0	3.5	0	0	3.4
46	1000	19.5	5.7	6.4	3.6	13.8	26.9
93	200	20.3	4.9	4.7	5.3	15.2	30.1
186	500	21.5	6.8	4.2	7.2	19.7	27.3

We selected 121 individual plants of high quality, treated with different doses of Gamma-rays to investigate their panicle traits (Table 3).

Table 3. Variation of some panicle traits of 121 selected H₂ individuals.

No. of individuals (%)	Panicle length		Spikelets per panicle		Grain shape				Length-width ratio		1000-grain weight (g)		waxy drop	
	-	+	-	+	long	short	wide	slim	-	+	-	+	-	+
52	15	811	15	16	1	6	8	2	12	1	6	8	2	
	43.0	12.4	67	12.4	13.2	0.8	5.0	6.6	1.7	9.9	0.8	5.0	6.6	1.7

* + = increase, - = decrease



Figure 1 Panicle mutants derived from mature pollen irradiated by Gamma-rays.

Panicle traits of H₂ plants showed a distinct two-way variation. Individuals showed 1000-grain weight lower (3g) or greater (8g) than the control group. The change in grain shape of individuals was mainly due

to an increase of grain length to 8.4-10.6 mm (Fig. 1), with an increase in length-width ratio from 2.5 to 3.2.

There were new characteristics in the H₂ population, including individuals with seed of a waxy appearance, low seed setting rate, similarity to multiploids (long awn and big grain), and altered color of the glume hull. Among the 121 plants chosen, 112 (92.6%) were from the group treated with 46Gy. Moreover, 27 of the 30 best plants (90%) were treated with 46Gy of Gamma-radiation, suggesting that this group had a higher frequency of useful variation.

Genetic variation of mutant traits of H₃, H₄ derived from mature pollen irradiated by Gamma-rays

Plant height, heading stage, seed setting rate and grain shape of each individual of the H₃ and H₄ generations were recorded (Table 4). The results showed that separation of traits of each individual of the H₃ and H₄ generations was still very complex. There was a wider mutation spectrum in H₃ and H₄ plants than that of H₂ plants. Three mutant quantitative traits of plant height, heading stage and grain length all had cumulative phenomena. Seed setting rate gradually became normal with further generations. For grain shape mutation, the large grain mutants of H₂ and H₃ showed high variability and grain weight exhibited a cumulative phenomenon.

Table 4. Comparisons of the range of separation of some traits in the H₂, H₃ and H₄ generations.

	Plant height (cm)	Heading stage (d)	Seed setting rate (%)	Grain length (mm)	1000-grain weight (g)
CK	15-105	0	Above 90	8.0-8.8	29-31
H2	40-115	3-3	Above 0.2-90	8.0-10.6	24-39
H3	57-140	15-15	Above 10-90	8.0-13.4	21-54
H4	70-155	15-not heading	Above 20-90	8.0-13.8	21-51

In all generations, the length, width and 1000-grain weight of rice grain and brown rice were measured at random (Table 5). The results indicated that the grain shapes generated by Gamma-irradiation of mature pollen were heterogeneous. The change in the grain shape for each generation was mainly in the grain length with an absolute increase of 5 mm (4.4 mm), or an increase of 56.8% (68.8%), but the grain width could increase and decrease for each individual grain. In all, the length-width ratio rose from 2.5 (2.1) in the original seed to 5.3 (4.5), with absolute increase of 2.8 (2.4). The appearance of rice had been greatly improved because of reduced chalkiness or no chalkiness.

Table 5. Ranges of variation of grain shapes of progenies derived from mature pollen irradiated by Gamma-rays.

No. of individuals	Rice grain			Brown rice			1000-grain weight (g)	
	Length (mm)	Width (mm)	Length-width ratio	Length (mm)	Width (mm)	Length-width ratio		
Ma85	5	8.4-8.8	3.4-3.8	2.2-2.5	6.0-6.3	3.0-3.3	1.9-2.0	29-31
Bai85	5	8.4-8.7	3.6-3.7	2.3-2.4	6.2-6.4	3.0-3.1	2.0-2.1	29-31
H ₂	18	8.3-10.6	3.0-3.5	2.4-3.2	6.0-8.4	2.4-3.1	2.0-3.3	24-37
H ₃	356	8.0-13.4	2.6-4.0	2.2-4.2	6.0-10.8	2.4-3.6	1.6-3.6	21-54
H ₄	110	8.4-13.8	2.6-4.2	2.2-4.3	6.2-10.2	2.0-3.4	1.6-4.0	21-54
H ₅	55	8.5-13.8	2.0-3.4	2.3-5.3	6.2-9.0	1.8-3.4	1.8-4.5	21-54
H ₆	42	8.4-11.6	3.0-3.8	2.2-4.6	6.2-9.0	2.4-3.6	1.9-4.5	21-54
H ₇	44	8.4-11.7	2.6-3.7	2.5-4.3	6.3-9.3	2.3-3.1	2.1-3.6	21-54

The mutant individuals with altered 1000-grain weight also showed positive and negative two-way variation (Fig. 1), with variation in H₂

being smaller and variation in H_3 being larger. From the H_4 generation on, its change was within the range of the H_3 generation. The absolute decline of 1000-grain weight was 8g (27.6%) and the absolute increase was 23 g (72.4%). Rice had a reduced rate of chalkiness and good quality within 10 g of a decrease or increase of the 1000-grain weight. When the 1000-grain weight was over 40g, rice had a big white belly, loose structure and poor quality. Grain shape was the major characteristic affected by of mutating mature pollen. There have been no previous examples of changes of such magnitude in rice mutation breeding programmes.

Genetic stability of mutant progenies derived from mature pollen irradiated by Gamma-rays

Genetic stability of various lines of mutant progenies derived from rice mature pollen irradiated by Gamma-ray was studied further. The results showed that mutations in H_2 and H_3 lines derived from mature pollen irradiated by Gamma-rays all appeared to separate, and that the H_3 generation had more mutant types and a broader spectrum of mutations than the H_2 generation. These mutant types included: extremely incompact, double gulme hulled, extremely dwarf and sterile plants. The generations above H_4 gradually became stable and the H_5 generation had more than 70% stable lines. Some individuals with low-seed setting rate and large grain were very difficult to stabilize and these traits still exhibited great variability in the H_{15} generation, indicating that mutation of some male gametes is very complicated.

Developing good quality early *indica* cultivars using mature pollen irradiated by Gamma-rays

Jiahezaozhan, a high-quality and yield early *indica* rice cultivar, was developed in 1996, using the hybridization of a mutant generated from mature pollen irradiated by Gamma-rays as its original female parent plant. Jiahezaozhan was the first early *indica* rice cultivar in Fujian province with its quality meeting the standards of Second Class Good Edible Rice issued by the Agriculture Ministry.

Jiafuzhan, a new early *indica* rice cultivar with a 1000-grain high quality weight of 30 g, high yield, resistance to blast, resistance to planthopper, and wide adaptability, was bred by crossing "Jiahezaozhan" as the a female parent with a mutant having a 1000-grain weight of 36.4 g derived from mature pollen irradiated by Gamma-rays. This cultivar received the first prize in Science and Technology in Fujian province, having an annual planting area of 66,700 hm² in Fujian province, and additional hectares in neighboring provinces [6].

Conclusion

A mutation technology using mature rice pollen irradiated with Gamma-rays was established, and has produced more than 200 stable mutant rice lines with large grain, high quality and good plant types, to date. It is a potent technology by which new mutant types can still be produced in the third generation, probably as a consequence of multiple recessive mutations. The inheritance of traits for very large grain and very low seed setting rate tend to be unstable, and progenies with these traits continue to produce new types of mutant.

The mutation technology using mature pollen irradiated by Gamma-rays, mainly induces point mutations. It is especially effective in producing mutations relating to yield components controlled by minor genes. These include mutants in growth stage, grain shape and grain weight. There is no other report describing such a rich repertoire of changes in the grain shape and rice quality generated by irradiating mutation of mature rice pollen.

Bautista [7] and Wang [8] have observed chromosome aberrations in progenies derived from irradiating rice pollen. Tang [3] found that phenotypic variation in the second generations derived from rice pollen irradiated with different doses of Gamma-rays was larger than the control group. Our work has demonstrated unambiguously that Gamma-ray irradiation can elicit mutational effects on mature rice pollen, in contrast to the previous reports by Chin, *et al.* [4, 5].

ACKNOWLEDGEMENTS

This work was supported by China National 863 Project (2007AA10Z179), Fujian platform of Science and Technology Innovation Project (2007N2005), Fujian Science and Technology Key Project (2008N0122) and by Xiamen Science and Technology Project (3502Z20083003).

BIBLIOGRAPHY

1. Wang, L.Q. Progress on plant mutation breeding in China. *Nuclear Agricultural Science Bulletin* **13**, 282-298 (1992).
2. Wang, L.Q. The contribution of mutation breeding to improving crop variety. *Nuclear Agricultural Science Bulletin* **11**, 283-286 (1990).
3. Tang, Y.L. Preliminary study on rice pollen irradiation mutation of cross parents. *Guangxi Agricultural Science* **3**, 18 (1995).
4. Chin, S.F., Gordon, G.H. Pollination with irradiated pollen in rice (*Oryza sativa* L.) I. First (M_1) Generation. *Heredity* **63**, 163-170 (1989a).
5. Chin, S.F., Gordon, G.H. Pollination with irradiated pollen in rice (*Oryza sativa* L.) II. The second (M_2) Generation. *Heredity* **63**, 171-180 (1989b).
6. Wang H.C. Huang H.K., Qiu S.M. *et al.* Breeding and Application of Jiafuzhan, A new breed of early Indica Rice of high quality, *Front. Biol. China*, **2**, 144-150 (2007).
7. Bautista A.T.S. Induction of chromosomal variants through pollen irradiation in rice. College, Laguna (Philippines), Mar. (1993).
8. Wang Z.X., Iwata N., Sukekiyo T., Yoshimura A. Induction of chromosome aberrant in rice (*Oryza sativa* L.) by using irradiated pollen. *Journal of the Faculty of Agriculture* **36**, 99-108 (1991).

CONCURRENT SESSION 7

High Throughput Techniques for Mutation Screening

Global TILLING Projects

B J Till*, R Afza, S Bado, O A Huynh, J Jankowicz-Cieslak, M Matijevic & C Mba

Abstract

Induced mutation and natural nucleotide variation are powerful tools for probing gene function and improving traits in plants. Traditional mutagenesis has been widely used in forward genetic strategies and has led to the release of over 2,000 mutant plant varieties. Mutagens such as ethyl methanesulphonate (EMS) cause stable point mutations and thus produce an allelic series of truncation and missense changes that can provide a range of phenotypes. TILLING (Targeting Induced Local Lesions IN Genomes) uses traditional mutagenesis and nucleotide polymorphism discovery methods for a reverse genetic strategy that is high in throughput, low in cost, and applicable to most organisms. In less than a decade, TILLING has moved from a proof of concept to a well-accepted reverse genetic method that has been applied to over 20 different species. Large-scale TILLING services have delivered thousands of induced mutations to the international research community. Advancements in new mutation discovery techniques promise to increase further the efficiency and applicability of the TILLING method. Here, we review the progress in TILLING and describe the work of the Plant Breeding Unit of the Joint FAO/IAEA Programme to establish TILLING platforms for banana, cassava, and rice.

Background

Heritable genotypic variation is a major contributor to phenotypic diversification, and thus a fundamental driver of evolution. Naturally occurring alleles and induced mutations can be used as tools to study plant gene function and to develop crops with agronomically important traits. This is exemplified by the FAO/IAEA mutant variety database that catalogues more than 2,000 officially released crop varieties developed through the use of induced mutations (<http://mvgs.iaea.org/>). In recent decades, there has been a tremendous growth in the acquisition of genomic DNA sequences for plants and animals. The sequencing of entire genomes has been completed for some plant species and many more are planned (<http://www.ncbi.nlm.nih.gov/sites/entrez?db=genomeprj>).

With this information, it is now possible to predict genes important for crop traits based on sequence homology to well-studied model species. Reverse-genetic strategies that target lesions to specific genes, therefore, hold great promise in speeding up the process of gene-function analysis, and enhancing the efficiency of mutation breeding. While a number of reverse-genetic strategies have been described, Targeting Induced Local Lesions in Genomes (TILLING) has emerged as a robust, high-throughput, non-transgenic method that can be applied to most species [1, 2].

The TILLING method

TILLING combines traditional mutagenesis followed by high-throughput mutation discovery (Fig. 1 [3, 4]). Mutagens such as ethylmethanesulphonate (EMS) are typically used to induce single base point mutations

randomly throughout the genome. When multicellular organs, such as seed, are mutagenized, the resulting adult plant is chimeric because different cells that make up the plant harbor different mutations. Chimeras must be dissolved through self-fertilization or *in vitro* techniques before mutation screening. For sexually propagated plants, the first non-chimeric generation (the M_2 when mutagenizing seed) is selected to create the mutant population. A single-seed descent strategy is typically used, and a single M_2 plant from an M_1 parent is selected to create a mutant line. DNA is extracted from M_2 plants for mutation screening and the plants are allowed to self-fertilize to create M_3 seed for later phenotypic characterization. The DNA and seed libraries can be used for many years. Tissue culture, *in vitro* propagation and double haploidy can be employed to increase the efficiency of preparing mutant populations in species that are recalcitrant to the approach described above. Because mutagens such as EMS induce mutations randomly throughout the genome, each mutant line will harbor distinct mutations. With proper balance of mutation density and population size, multiple point alleles can be obtained in relatively small populations. For example, approximately 14 single-base mutations can be discovered when screening a 1.5kb gene fragment in a population of 3,000 mutagenized *Arabidopsis* plants (<http://tilling.fhcrc.org/arab/status.html>; [5]).

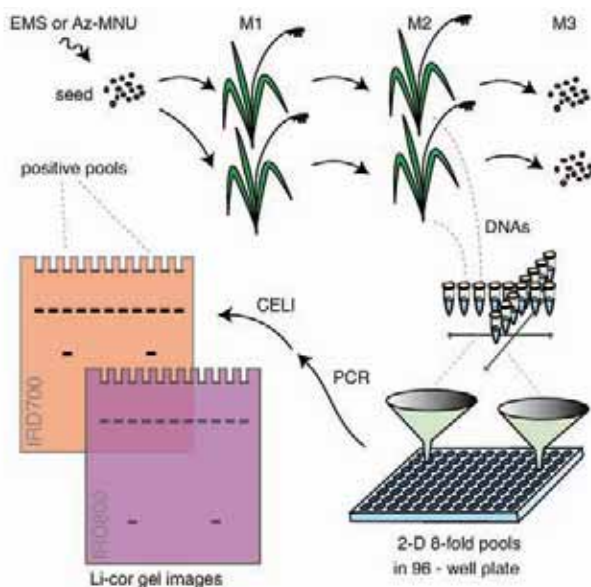

Figure 1 A typical TILLING strategy using seed mutagenesis. The first generation (M_1) is chimeric because of the multicellular composition of the seed at mutagenesis, making it unsuitable for mutation discovery. M_2 plants are non-chimeric and suitable for TILLING. DNA from each M_2 is collected for mutation screening and M_3 seed is collected and stored as the germplasm stock. DNAs are normalized to a common concentration, arrayed in 96 well plates, and pooled prior to screening to increase screening efficiency (a two-dimensional eight-fold pooling strategy is shown in this figure). DNAs are screened for mutations by PCR with gene-specific primers followed by mutation discovery via enzymatic mismatch cleavage, followed by fluorescence detection using denaturing polyacrylamide gel electrophoresis. This figure of a rice TILLING strategy is modified from [18].

Plant Breeding Unit, FAO/IAEA Agricultural & Biotechnology Laboratory, Joint FAO/IAEA Programme, International Atomic Energy Agency, Vienna, Austria

* Corresponding author. E-mail: b.till@iaea.org

Any method that can be used to identify single nucleotide mutations and small indels can be used for mutation discovery in TILLING. The first method described was denaturing HPLC [6, 7]. A variety of approaches have since been described, including direct sequencing and enzymatic mismatch cleavage with slab and capillary gel electrophoresis [3, 8–10]. A common approach is enzymatic mismatch cleavage using single-strand specific nucleases followed by denaturing polyacrylamide gel electrophoresis and fluorescence detection using the LI-COR DNA analyzer [11]. In this method, gene-specific fluorescently end-labeled PCR primers are used to amplify a ~1.5 kb genomic target. After PCR, samples are denatured and annealed to create heteroduplexed molecules from polymorphic amplicons. Mismatches in double-stranded molecules form at the location of induced mutations. Mismatches are cleaved by incubating DNA with a single-strand specific nuclease in a crude celery juice extract [12]. Samples are size fractionated and fluorescent signals detected using the LI-COR analyzer. The sum of the molecular weights of cleaved fragments equals the molecular weight of the full-length PCR product indicating the presence of a mutation. The molecular weights of fragments also indicate the position of the mutation to within ~10 base pairs [13]. Once discovered, mutations can be sequenced to determine the exact nucleotide change, and programmes such as PARSESNP can be used to estimate the effect of nucleotide changes on protein function [14]. Mutation discovery throughput can be increased and screening cost reduced by pooling samples up to eight-fold [3].

Examples of TILLING projects

TILLING projects have been reported for a large number of species including *Arabidopsis*, barley, *Drosophila*, maize, rice, soybean, and wheat (Table 1). The utility of TILLING for mutation breeding was shown by Slade and colleagues who used the method to develop wheat producing low amounts of amylase [15]. In addition to providing useful mutants, analysis of the spectrum and density of mutations can provide insights into the process of mutagenesis. For example, analysis of ~2,000 induced mutations indicates that EMS causes >99% G/C-A/T transition changes in the *Arabidopsis* genome and that mutations are distributed randomly across all chromosome arms [13]. Analysis of more than 2,000 induced mutations in *Drosophila* provided insight into the maintenance of mutations in populations propagated over 100 generations [16].

Table 1. Spectrum and density of induced mutations identified by TILLING.

Organism	Mutagen	Population screened	Spectrum of mutations	Mutation density (mutations/kb)	References
<i>Arabidopsis</i>	EMS	3000	>99% GC→AT	1/200	[5, 13]
Barley	EMS	4600	70% GC→AT	1/1000	[22]
<i>C. elegans</i>	EMS	1500	96% GC→AT	1/293	[23]
<i>Drosophila</i>	EMS (Ch2)*	5600	70% GC→AT	1/480	[16]
	EMS (Ch3)	6000	76% GC→AT	1/380	
Maize	EMS	750	>99% GC→AT	1/500	[19]
Pea	EMS	3072	100% GC→AT	1/669	[24]
Rice	EMS	768	70% GC→AT	1/290	[18]
			11% AT→GC		
	Az-MNU		67% GC→AT 20% AT→GC	1/270	
	MNU	767	92% GC→AT	1/135	[9]
	Gamma ray	2130	50% Transversion 17% Transition 33% small indel	1/6190 kb	[25]
Soybean	MNU	529	~90% GC→AT	1/140	[17]
	EMS	768	~90% GC→AT	1/140	
	EMS	768	~90% GC→AT	1/250	
	EMS	768	~75% GC→AT	1/550	
Wheat	EMS	1920	~99% GC→AT	1/40 (tetraploid)	[15]
				1/24 (hexaploid)	

* Separate populations balanced for mutations on chromosome 2 (Ch2) and 3 (Ch3) were screened.

The high-throughput and low-cost nature of TILLING has allowed the creation of public TILLING services. The first operational TILLING service was the *Arabidopsis* TILLING Project (ATP; [5]). In operation since 2001, ATP has delivered more than 8,000 induced mutations to *Arabidopsis* researchers in many countries (<http://tilling.fhcr.org/arab/status.html>). To streamline the service, a system for online ordering and automated generation of mutation reports was developed and incorporated into ATP and the later-developed Maize TILLING Project, and Fly-TILL screening services (http://tilling.fhcr.org/fly/Welcome_to_Fly-TILL.html, <http://genome.purdue.edu/maizetilling/>). Other TILLING services include those for rice (http://tilling.ucdavis.edu/index.php/Main_Page) and barley (<http://bioinf.scri.ac.uk/barley/>, <http://www.distagenomics.unibo.it/TILLMore/>). Because methods for mutation discovery are largely the same across species, a single screening facility can provide multiple TILLING services, benefiting from an economy of scale and centralization of expertise. For example, the Seattle TILLING Project currently provides the ATP and Fly-TILL services and has completed small-scale pilot projects to evaluate the efficacy of TILLING in maize, rice, and soybean (<http://tilling.fhcr.org/>, [17–19]). Likewise, RevGenUK provides TILLING services for Lotus and Medicago (<http://revgenuk.jic.ac.uk/>). Many other groups are involved in multi-species projects (for example, <http://www.gabi-till.de/>).

Global TILLING for developing countries

Success stories from TILLING suggest that this technology can be incorporated into the tool-kit of approaches for improving food security in developing nations. As a reverse-genetic approach, TILLING can improve the efficiency of using induced mutations to develop crops with improved traits. For example, knowledge of the spectrum and density of induced mutations in a population allows one to calculate the size of the population required to obtain desired alleles. In *Arabidopsis*, with a mutation density of ~1 mutation/200 kb, an average of 14 mutations in a 1.5 kb region can be obtained by screening ~3,000 plants (<http://tilling.fhcr.org/arab/status.html>). This is sufficient to deliver one predicted deleterious allele at least 95% of the time in 75% of all gene targets (http://tilling.fhcr.org/files/user_fees.html). Because genes in *Arabidopsis* are typically 3–4kb, a population size of 3,000 is sufficient to find deleterious alleles in many genes. To have the same chance of finding deleterious mutations in a maize TILLING population with a density of ~1/500 kb would require screening ~7,500 plants. Mutation densities can be estimated by screening a small subset of the population (~800 plants), and the decision to proceed with the population or to generate a new population can be made prior to a full-scale investment in thousands of plants. Thus, TILLING provides a means of reducing population size and increasing the chances of obtaining useful mutations when compared to traditional forward strategies where mutation densities are unknown. Furthermore, TILLING allows the discovery of mutations that provide no phenotype by themselves, but can when combined with others. This is important for duplicated genes, genes with redundant functions and in polyploid species such as wheat, where recessive traits are not likely to be obtained by traditional forward screens and mutation breeding [20, 21].

Induced mutation for plant breeding has been a powerful approach used by the FAO/IAEA Joint Programme. The Plant Breeding Unit has provided a plant mutagenesis service for decades, and maintains expertise in mutagenesis, plant growth and mutant evaluation that is shared with Member States. The Plant Breeding Unit (PBU) is therefore well-positioned to increase the efficiency of using induced mutations by establishing a TILLING facility that can serve Member States. Incorporating methods to improve efficiency is timely because a growing population and changing climate is expected to put increasing pressures on food security. We have chosen three crops: banana, cassava, and rice, to develop a TILLING platform at the PBU. Pilot-scale studies with all three crops have been successful, suggesting the efficacy of a centralized-

facility approach to providing reverse-genetics for crops important to developing nations. Mutagenized banana and cassava populations have been developed in-house and initial screening is promising. We have begun to collaborate with other groups to screen the mutant populations they have developed. We hope to expand this work to include more crops.

ACKNOWLEDGMENTS

We are grateful to all the organizations, institutions and individuals who collaborate with or provide materials to the Plant Breeding Unit. The Food and Agriculture Organization of the United Nations and the International Atomic Energy Agency through their Joint FAO/IAEA Programme of Nuclear Techniques in Food and Agriculture provide generous support for the work of the Plant Breeding Unit at the Agency's laboratories in Seibersdorf, Austria.

BIBLIOGRAPHY

- Till, B.J., Comai, L., Henikoff, S. Tilling and Ecotilling for crop improvement. In: *Genomics-Assisted Crop Improvement* (R. K. Varshney, and R. Tuberosa, Eds.), Vol. 1: Genomics Approaches and Platforms, p.333-349. Springer Netherlands (2007).
- Tisser, A., Bourgeois, P. Reverse Genetics in Plants. *Current Genomics* **23**, 269-284 (2001).
- Colbert, T., Till, B.J., Tompa, R., Reynolds, S., Steine, M.N., Yeung, A.T., McCallum, C.M., Comai, L., Henikoff, S. High-throughput screening for induced point mutations. *Plant Physiol.* **126**, 480-4 (2001).
- McCallum, C.M., Comai, L., Greene, E.A., Henikoff, S. Targeted screening for induced mutations. *Nat. Biotechnol* **18**, 455-7(2000a).
- Till, B.J., Reynolds, S.H., Greene, E.A., Codomo, C.A., Enns, L.C., Johnson, J.E., Burtner, C., Odden, A.R., Young, K., Taylor, N.E., Henikoff, J.G., Comai, L., Henikoff, S. Large-scale discovery of induced point mutations with high-throughput TILLING. *Genome Res* **13**, 524-30 (2003).
- Bentley, A., MacLennan, B., Calvo, J., and Dearolf, C.R. Targeted recovery of mutations in *Drosophila*. *Genetics* **156**, 1169-73 (2000).
- McCallum, C.M., Comai, L., Greene, E.A., Henikoff, S. Targeting induced local lesions IN genomes (TILLING) for plant functional genomics. *Plant Physiol.* **123**, 439-42 (2000b).
- Perry, J.A., Wang, T.L., Welham, T.J., Gardner, S., Pike, J.M., Yoshida, S., Parniske, M. A TILLING reverse genetics tool and a web-accessible collection of mutants of the legume *Lotus japonicus*. *Plant Physiol.* **131**, 866-71 (2003).
- Suzuki, T., Eiguchi, M., Kumamaru, T., Satoh, H., Matsusaka, H., Moriguchi, K., Nagato, Y., Kurata, N. MNU-induced mutant pools and high performance TILLING enable finding of any gene mutation in rice. *Mol. Genet. Genomics* **279**, 213-23 (2008).
- Wienholds, E., van Eeden, F., Kusters, M., Mudde, J., Plasterk, R.H., Cuppen, E. Efficient target-selected mutagenesis in zebrafish. *Genome Res* **13**, 2700-7 (2003).
- Till, B.J., Zerr, T., Comai, L., Henikoff, S. A protocol for TILLING and Ecotilling in plants and animals. *Nat Protoc* **1**, 2465-77 (2006).
- Till, B.J., Burtner, C., Comai, L., Henikoff, S. Mismatch cleavage by single-strand specific nucleases. *Nucleic Acids Res* **32**, 2632-41 (2004a).
- Greene, E.A., Codomo, C.A., Taylor, N.E., Henikoff, J.G., Till, B.J., Reynolds, S.H., Enns, L.C., Burtner, C., Johnson, J.E., Odden, A.R., Comai, L., Henikoff, S. Spectrum of chemically induced mutations from a large-scale reverse-genetic screen in *Arabidopsis*. *Genetics* **164**, 731-40 (2003).
- Taylor, N.E., Greene, E.A. PARSESNP: A tool for the analysis of nucleotide polymorphisms. *Nucleic Acids Res* **31**, 3808-11 (2003).
- Slade, A.J., Fuerstenberg, S. I., Loeffler, D., Steine, M. N., Facciotti, D. A reverse genetic, nontransgenic approach to wheat crop improvement by TILLING. *Nat Biotechnol* **23**, 75-81 (2005).
- Cooper, J.L., Greene, E.A., Till, B.J., Codomo, C.A., Wakimoto, B.T., Henikoff, S. Retention of induced mutations in a *Drosophila* reverse-genetic resource. *Genetics* **180**, 661-7 (2008a).
- Cooper, J.L., Till, B.J., Laport, R.G., Darlow, M.C., Kleffner, J.M., Jamai, A., El-Mellouki, T., Liu, S., Ritchie, R., Nielsen, N., Bilyeu, K.D., Meksem, K., Comai, L., Henikoff, S. TILLING to detect induced mutations in soybean. *BMC Plant Biol* **8**, 9 (2008b).
- Till, B. J., Cooper, J., Tai, T. H., Colowitz, P., Greene, E. A., Henikoff, S., Comai, L. Discovery of chemically induced mutations in rice by TILLING. *BMC Plant Biol* **7**, 19 (2007).
- Till, B.J., Reynolds, S.H., Weil, C., Springer, N., Burtner, C., Young, K., Bowers, E., Codomo, C.A., Enns, L.C., Odden, A.R., Greene, E.A., Comai, L., Henikoff, S. Discovery of induced point mutations in maize genes by TILLING. *BMC Plant Biol* **4**, 12 (2004b).
- Enns, L.C., Kanaoka, M.M., Torii, K.U., Comai, L., Okada, K., Cleland, R.E. Two callose synthases, GSL1 and GSL5, play an essential and redundant role in plant and pollen development and in fertility. *Plant Mol Biol* **58**, 333-49 (2005).
- Slade, A.J., Knauf, V.C. TILLING moves beyond functional genomics into crop improvement. *Transgenic Res* **14**, 109-15 (2005).
- Caldwell, D.G., McCallum, N., Shaw, P., Muehlbauer, G.J., Marshall, D.F., Waugh, R. A structured mutant population for forward and reverse genetics in Barley (*Hordeum vulgare* L.). *Plant J* **40**, 143-50 (2004).
- Gilchrist, E.J., O'Neil, N.J., Rose, A.M., Zetka, M.C., Haughn, G.W. TILLING is an effective reverse genetics technique for *Caenorhabditis elegans*. *BMC Genomics* **7**, 262 (2006).
- Triques, K., Sturbois, B., Gallais, S., Dalmais, M., Chauvin, S., Clepet, C., Aubourg, S., Rameau, C., Caboche, M., Bendahmane, A. Characterization of *Arabidopsis thaliana* mismatch specific endonucleases: application to mutation discovery by TILLING in pea. *Plant J* **51**, 1116-25 (2007).
- Sato, Y., Shirasawa, K., Takahashi, Y., Nishimura, M., Nishio, T. Mutant Selection from Progeny of Gamma-ray-irradiated Rice by DNA Heteroduplex Cleavage using Brassica Petiole Extract. *Breeding Science* **56**, 179-183 (2006).

TILLING with TILLMore

V Talamè^{1,*}, R Bovina¹, S Salvi¹, M C Sanguineti¹, P Piffanelli², U Lundquist³ & R Tuberosa¹

Abstract

A TILLING (Targeting Induced Local Lesion IN Genomes) resource in barley (cv. Morex) consisting of 4,906 families was produced by sodium azide (NaN₃) seed treatment. This resource has been named TILLMore. TILLMore was screened for mutants at several genes based on the analysis of 8- to 12-fold DNA pools produced from DNA samples from M₂ or M₃ plants. An average of about six alleles per gene was identified, which corresponds to a rate of one mutation per every 428kb. Almost all the mutations detected were C/G to T/A transitions and several (ca. 58%) implied a change in amino acid sequence, hence possible effects on phenotype. The mutagenized barley population, although developed for reverse-genetics purposes, is also a valuable resource for forward-genetics studies. A high frequency of M₃ families (ca. 33%) showed morphological alterations, which have been scored regularly during the growing seasons in reference to wild-type Morex plants (www.distagenomics.unibo.it/TILLMore/). In particular, a preliminary screening for phenotypes at the root level showed altered root morphology for ca. 7% of the families. Our results indicate the feasibility of using this collection of materials to investigate gene function in barley and closely related crops.

Introduction

One of the most widely adopted approaches in biological research is mutational analysis where chemical or physical mutagenesis is used to achieve a large-scale random gene inactivation in a population of plants. Forward genetics based on the phenotypic identification of individual mutations has been the most widely used tool in understanding the genetic control of plant development. However, this approach is not always effective in filling in the gap between gene structure and function; additionally, considerable efforts are needed to identify rare mutations [1]. These limitations can be overcome by high-throughput reverse-genetics tools that allow us to identify mutations in genes that are known only by their sequence.

Among other high-throughput reverse-genetics approaches, TILLING (Targeting Induced Local Lesion IN Genomes) is a technique combining chemical mutagenesis with a sensitive DNA screening-technique that enables the recovery of individuals carrying allelic variants at candidate genes [2]. TILLING can be applied to either chemically mutagenized populations or a collection of genotypes (e.g. cultivars, ecotypes, landraces and wild accessions), this latter approach also known as EcoTILLING [3]. TILLING can be applied essentially to any species, without significant differences in protocol. Since its first introduction, TILLING has been successfully used as a functional genomics discovery platform both in plants [2, 4, 5, 6, 7, 8, 9, 10] and animal species [11, 12, 13], and more TILLING resources are underway in model and non-model species. This study describes the utilization of TILLMore, our

recently developed sodium azide-mutagenized barley population in a cv. Morex background [10], both for reverse and forward-genetics studies.

Materials and Methods

TILLING analysis

DNA preparation and pooling. Genomic DNA isolated from the whole TILLMore population, including 4,906 M_{3/4} families, was quantified and diluted to a concentration of 30 ng/μl and used for serial dilution stocks of 10 and 2.5 ng/μl. Two different DNA stocks were prepared: one referred to 3,148 samples collected from M₂ plants, while the second DNA stock referred to the whole TILLMore population of 4,906 M₃ families. The first DNA stock was pooled four-fold and then combined to obtain eight-fold pools. The second DNA stock was pooled according to a two-dimensional gridding strategy combining all samples both in eight and in twelve-fold pools.

Mutation screening. The primer design, based on the Morex genomic sequence, was carried out using CODDLE (<http://www.proweb.org/coddle>; [14]) and Primer3 (<http://frodo.wi.mit.edu/>; [15]). PCR amplification was conducted as described in [16]. Amplified samples were digested with CeiI nuclease according to the manufacturer's directions for the Surveyor[®] Mutation Detection Kit for agarose gel (Transgenomics Inc., Omaha, NE, USA) and to the protocol described in [16]. Electrophoresis was performed either on a LI-COR4200 gel analyzer (LI-COR Inc., USA) according to the protocol described in [16] or on an ABI3730 capillary DNA Sequencer (ABI, USA) according to [11] with minor modifications. Images were analyzed visually for the presence of cleavage products using Adobe Photoshop software (Adobe Systems Inc.). Presumptive mutants were subsequently confirmed by sequencing genomic DNA using the ABI BigDye Terminator V1.1 Cycle Sequencing Kit (Applied Biosystems, Foster City, CA, USA). Sequences of mutant alleles were analyzed with the SIFT [17] and PARSESNP [14] programmes in order to rank mutations based on probability of affecting protein function.

Forward-genetics screening

The entire TILLMore population of 4,906 M_{3/4} families obtained by sodium-azide seed treatment was grown in the field and scored for visible phenotypes with reference to untreated Morex. Phenotypic information was collected as to habitus, heading date, leaf appearance, presence of necrotic spots, plant color, plant height, plant morphology, spike appearance and tillering.

To detect alterations in root morphology, a preliminary analysis of ca. 1,000 M₃ families was carried out using a paper-roll technique [18]. About 12 seeds/family/paper-roll were grown under controlled conditions (16/8 h photoperiod and 24/22°C day and night, respectively) in a replicated screen. Observations and measurements of seminal roots were performed on eight-day-old seedlings with reference to untreated Morex.

¹ Department of Agroenvironmental Sciences and Technology, Viale Fanin 44, 40127 Bologna, Italy

² Genomics Platform, CERSA, Parco Tecnologico Padano (PTP-Lodi), Via Einstein, 26900 Lodi, Italy

³ Nordic Genetic Resource Center, SE-230 53 Alnarp, Sweden

* Corresponding author. E-mail: valentina.talame2@unibo.it

Results and Discussion

TILLMore reverse-genetics screening

We screened TILLMore with assays designed for 11 target genes involved in different aspects of barley development and metabolism. The target genes were either analyzed for internal use or for scientific collaborations or screened for other research groups (Table 1). The molecular screening of the first set of five genes was carried out on 3,148 samples using a *CeII*-based heteroduplex assay coupled with gel-electrophoretic detection on a LI-COR analyzer, screening for mutations in eight-fold sample pools. For the second group of six genes, we used an ABI3730 sequencer system on the entire population of 4,906 samples, screening for mutations in eight and twelve-fold sample pools. The two methods showed comparable mutation frequencies in reference to the total number of samples screened.

For each TILLed gene, the molecular screening yielded an allelic series of mutants with an average of ca. six alleles per gene corresponding to a mutation density of ca. one mutation every 428kb. This parameter was estimated by dividing the number of base pairs screened by the total number of identified mutations. Considering that mutations placed in the terminal 80bp of both ends of the amplicon can escape identification due to PCR priming and electrophoresis artefacts, a correction for the effective screening window was applied by subtracting 160bp from the length of each amplicon [19].

A total of 69 point mutations were identified at the target genes. In 13 cases the mutations were in non-coding regions. Of the 56 point mutations identified in coding regions, some (29%) are predicted to be silent because they affect the third base of a codon which does not change the amino acid encoded by that codon, while 70% of them are missense alleles resulting in a change in one of the amino acids in the protein encoded by the gene (Table 1). Only one truncation mutation was identified for the targeted genes.

Table 1. TILLMore mutation screening

Gene	PCR size (bp)	Non-sense	Missense	Silent	Non coding	Total	User
BRXL	940	-	3	2	4	9	TILLMore
HvCO1	830	-	2	1	-	3	TILLMore
HvEXPB1	997	-	3	1	-	4	TILLMore
NR	990	-	7	3	-	10	TILLMore
RPD1	670	-	4	3	2	9	TILLMore
eIF4E	525	-	3	-	2	5	Collaboration
HvFZP	560	-	3	4	-	7	Collaboration
Rpg1	908	-	3	-	1	4	Collaboration
#1	677	-	5	1	1	7	Customer
#2	963	1	5	-	-	6	Customer
#3	789	-	1	1	3	5	Customer
Total	9149	1	39	16	13	69	

Of the 69 lesions, only two were C/G to A/T transversion, while 67 were G/C to A/T transitions. Although a base transition mechanism has been postulated to explain the mutagenic effect of sodium azide [20], the exact type of NaN_3 -derived mutants has not been described exhaustively in terms of nucleotide changes. To our knowledge, only one study investigating the nucleotide changes induced by NaN_3 in barley has been published to date [21]. The authors proposed that NaN_3 causes mutations of transition type. Although limited to few genes, our results combined with those reported by Olsen and colleagues [21] reinforce the hypothesis that NaN_3 -induced sequence alterations in barley are mainly transitions. Due to these considerations, plus the finding that all but two

of our mutations are G/C to A/T transitions, we feel confident in ruling out the possibility that they are naturally occurring polymorphisms due to seed contamination of the original Morex seed stock used for this study.

For the prediction of the impact of mutations on protein function, we utilized bioinformatic methods like PARSESNP [17, 14]. It is expected that values of SIFT or PSSM (for PARSESNP) scores above specific thresholds indicate missense mutations which are more likely to have a deleterious effect on protein function. In our case, five mutations showed significant PSSM values, while the application of the SIFT algorithm predicted possible deleterious effects for only two mutations.

Forward-genetics screening

The main purpose of our mutagenized barley population was the implementation of a TILLING resource facility to be used for reverse-genetics screenings. However, the same population can also be used for forward-genetics studies.

For this purpose, the 4,906 M_3 families were grown in the field and visible phenotypes were scored during the growing season with reference to untreated Morex plants. A visible variant phenotype was recorded for 32.7% of the M_3 families (1,605/4,906) either fixed or segregating within the family (Figure 1). Changes in plant color, including families showing segregation for albino seedlings, was the phenotype most frequently observed (27% of mutated families; 12% of total families).

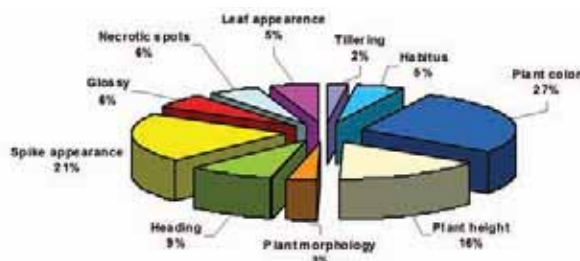

Figure 1 Proportions of different types of altered phenotypes in reference to cv. Morex recorded among M_3 families grown in field conditions.

Furthermore, a preliminary study of root morphology in 1,000 M_4 families by means of a paper-roll technique allowed the detection of putative mutants showing, for instance, a reduction of root length and severe modifications in root appearance and growth. About 7% of the families tested showed a clearly altered root phenotype. In order to confirm the observed phenotype the paper-roll screening will be repeated for the putative mutants identified during this preliminary screening.

An online database with further information on phenotypes observed in the forward-genetics screening is publicly accessible at www.distagenomics.unibo.it/TILLMore/ and seed is available upon request.

Conclusions

Our report confirms that TILLMore, a TILLING resource recently developed in Morex barley, is suitable for both forward- and reverse-genetics screening. The use of NaN_3 provided an efficient alternative to more commonly used mutagenic agents to obtain a high mutation density suitable for TILLING. TILLMore is available to the research community, both as forward and reverse-genetics resources, on a cost-recovery basis and/or through collaborations (for details, see www.distagenomics.unibo.it/TILLMore/).

ACKNOWLEDGEMENTS

We would like to thank Luca Comai and Bradley Till for helpful discussion and advice; Sandra Stefanelli and Stefano Vecchi for technical assistance. This work was supported by FIRB-Ministry of Research and University, Italy and IAEA-International Atomic Energy Agency.

BIBLIOGRAPHY

1. Stemple, D.L. TILLING - a high-throughput harvest for functional genomics. *Nat. Rev. Genet.* **5**, 145-150 (2004).
2. McCALLUM, C.M. *et al.* Targeted screening for induced mutations. *Nat. Biotechnol.* **18**, 455-457 (2000).
3. Comai, L. *et al.* Efficient discovery of DNA polymorphisms in natural populations by EcoTILLING. *Plant J.* **37**, 778-786 (2004).
4. Perry, J.A. *et al.* A TILLING reverse genetics tool and a web-accessible collection of mutants of the legume *Lotus japonicus*. *Plant Physiol.* **131**, 866-871 (2003).
5. Till, B.J. *et al.* Discovery of induced point mutations in maize genes by TILLING. *BMC Plant Biol.* **28**, 4-12 (2004).
6. Caldwell, D.G. *et al.* A structured mutant population for forward and reverse genetics in barley (*Hordeum vulgare* L.). *Plant J.* **40**, 143-150 (2004).
7. Till, B.J. *et al.* TILLING and EcoTILLING for crop improvement. In: *Genomics-Assisted Crop Improvement. Vol. 1: Genomics Approaches and Platforms* (Varshney, R.K., Tuberosa, R., Eds.). Springer, Dordrecht, 333-349 (2007).
8. Slade, A.J. *et al.* A reverse genetic, nontransgenic approach to wheat crop improvement by TILLING. *Nature Biotechnol.* **23**, 75-81 (2005).
9. Suzuki, T. *et al.* MNU-induced mutant pools and high performance TILLING enable finding of any gene mutation in rice. *Mol. Genet. Genomics* **279**, 213-223 (2008).
10. Talamè, V. *et al.* TILLMore, a resource for the discovery of chemically induced mutants in barley. *Plant Biotechnol. J.* **6**, 477-485 (2008).
11. Wienholds, E. *et al.* Efficient target-selected mutagenesis in zebrafish. *Genome Res.* **13**, 2700-2707 (2003).
12. Winkler, S. *et al.* Target-selected mutant screen by TILLING in *Drosophila*. *Genome Res.* **15**, 718-723 (2005).
13. Gilchrist, E.J. *et al.* TILLING is an effective reverse genetics technique for *Caenorhabditis elegans*. *BMC Genomics* **7**, 262 (2006).
14. Taylor, N.E., Greene, E.A. PARSESNP: A tool for the analysis of nucleotide polymorphisms. *Nucleic Acids Res.* **31**, 3808-3811 (2003).
15. Rozen, S., Skaletsky H.J. Primer3 on the WWW for general users and for biologist programmers. *Methods Mol. Biol.* **132**, 365-386 (2000).
16. Colbert, T. *et al.* High-throughput screening for induced point mutations. *Plant Physiol.* **126**, 480-484 (2001).
17. Ng, P.C., Henikoff, S. Predicting deleterious amino acid substitutions. *Genome Res.* **11**, 863-874 (2001).
18. Woll, K. *et al.* Isolation, characterization and pericycle-specific transcriptome analyses of the novel maize lateral and seminal root initiation mutant rum1. *Plant Physiol.* **139**, 1255-1267 (2005).
19. Greene, E.A. *et al.* Spectrum of chemically induced mutations from a large-scale reverse-genetic screen in *Arabidopsis*. *Genetics* **164** (2003) 731-740.
20. Kleinhofs, A. *et al.* Azide. *Mutat. Res.* **55**, 165-195 (1978).
21. Olsen, O. *et al.* Sodium azide mutagenesis: preferential generation of A-T-G-C transitions in the barley *Ant18* gene. *Proc. Natl. Acad. Sci. USA* **90**, 8043-8047 (1993).

EMAIL - A Highly Sensitive Tool for Specific Mutation Detection in Plant Improvement Programmes

L S Lee^{1,*}, M J Cross^{2,3} & R J Henry^{2,3}

Abstract

TILLING (Targeting Induced Local Lesions IN Genomes) is a useful tool for discovery of specific point mutations in genes of interest to plant breeders. It employs mismatch cleavage detection using endonucleases, particularly CEL I and CEL II. However, conventional protocols are limited in their ability to detect mismatch cleavage due to non-specific removal, by the nuclease, of 5' end-labelled termini. Mutation detection is further limited by the high background characteristic of PCR-based end-labelling mismatch scanning techniques. Here we show that, as nuclease activity increased, internal signal was maintained while 5' signal decayed and that internal labelling reduced the background signal. A new mismatch scanning assay called 'Endonucleolytic Mutation Analysis by Internal Labelling' (EMAIL), was developed using capillary electrophoresis, involving internal amplicon labelling by PCR incorporation of fluorescently-labelled deoxynucleotides. Multiple mutations amongst allelic pools were detected when EMAIL was applied with the mismatch nucleases CEL I and CEL II. This technique offers greatly increased sensitivity in the detection of mutations in specific genes in pooled samples, enabling enlarged pool sizes and improving throughput and efficiency. We are investigating the limits of pool sizes to deliver a highly efficient mutation detection and analysis strategy for plant breeders and geneticists.

Introduction

Over the past decade, the TILLING technique (Targeting Induced Local Lesions IN Genomes) has proven to be a useful tool for the discovery of specific point mutations in genes of interest to plant breeders and other researchers [1, 2]. The approach employs mismatch cleavage detection using endonucleases, particularly the enzymes CEL I and CEL II. During PCR annealing, heteroduplexes in dsDNA arise in pooled genomic DNA samples which contain one or more Single Nucleotide Polymorphisms (SNP), resulting, for instance, from induced mutation. The cleaved fragments can be distinguished from the larger perfectly-matched homoduplex DNA of the unmutated wild types in the sample of pooled individuals. The ability to efficiently detect individuals with specific mutations within pools of samples, provides plant breeders with a powerful early-screening tool with which to greatly reduce the numbers of plants requiring phenotypic assessment. Further, it enables geneticists to analyze gene function and associate genotype with phenotype.

TILLING was developed for scanning populations harboring point mutations derived primarily by chemical mutation, typically using ethyl methanesulfonate (EMS) [3], and extended to detection of natural mutants [4, 5]. Recently, however, TILLING has also proven useful in scanning gamma-irradiated mutant populations [6].

Mismatch detection protocols suffer from a limited ability to detect the mismatch cleavage signal due to non-specific removal, by the nuclease, of 5' end-labelled termini used in the conventional approach. Mutation detection is further limited by the high background that is characteristic of PCR-based end-labelling mismatch scanning techniques. By studying the activity of CEL nucleases using amplicon substrates labelled both internally and at each 5' terminus, we showed that, as nuclease activity increased, internal signal was maintained while 5' signal decayed. Furthermore, the background using internal labelling was reduced relative to conventional end-labelling techniques. The loss of end-signal constitutes a fundamental problem with the conventional approach to mismatch scanning with CEL nucleases.

An improved technique

A new mismatch scanning assay has been developed using capillary electrophoresis, in which amplicon labelling is achieved by PCR incorporation of fluorescently-labelled deoxynucleotides. We have named this strategy 'Endonucleolytic Mutation Analysis by Internal Labelling' (EMAIL) [7]. Multiple mutations amongst allelic pools have been detected when the EMAIL assay was applied with the mismatch nucleases CEL I and CEL II.

The electropherogram in Fig. 1 shows the effect of internal labelling compared to 5' end-labelling. The upper panel shows a sample pool detected with end-labelling; the lower panel shows the result of internal labelling. The sample comprised a six-fold genomic DNA pool consisting of four homozygous wild-type rice (*Oryza sativa*) individuals, but with inclusion of two additional homozygous mutant individuals. The rice samples consisted of cultivars highly characterized for their SNP content in exon 8 of starch synthase IIa. The mutant cultivars were known to contain SNP of A>G (SNP3) and GC>TT (SNP4) at positions 2412 and 2543-2544, respectively [8] (NCBI cDNA accession AF419099).

The electropherogram panels represent different dye traces from a single injection of purified heteroduplex digestion products following 18 minutes of CEL I activity. The single PCR product was amplified from the genomic DNA pool, consisting of homozygous wild-type individuals plus the homozygous mutant individuals, SNP3 and SNP4. The PCR product is in one instance end-labelled at both 5'-termini with HEX (hexachloro-6-carboxyfluorescein), and in the other case, internally-labelled with fluorescent dUTP [R110] (6-carboxyrhodamine), represented by the green and blue traces respectively. [R110]-labelled nucleotides were present in the PCR at 4µM. Peaks are noted for each site of mismatch cleavage. In each case, the ~5nt shorter internally labelled peak (lower panel) is of a considerably higher signal strength than its end-labelled counterpart (upper panel). Both cleavage fragments from SNP3, and the larger fragment from SNP4 are detectable, however, detection of the ~100bp cleavage fragment from SNP4 in the end-labelled sample is limited due to significant background in the small size range. In the internally labelled trace, all cleavage fragments from SNP3 and SNP4 are clearly detectable, both due to increased signal strength and reduced background, especially in the small size range. Although

¹ Center for Tropical Crops and Biocommodities, Queensland University of Technology, Brisbane, Australia

² Center for Plant Conservation Genetics, Southern Cross University, Lismore, Australia

³ Grain Foods CRC Ltd, 1 Rivett Road, North Ryde, Australia

* Corresponding author. E-mail: slade.lee@qut.edu.au

incomplete removal of [R110]dUTP artefacts (see lower panel) has resulted in carry-over, this does not pose significant problems for the purposes of mutation scoring, since the resultant interference is at two single-points, the 'size' of which is expected at ~76 and ~141 'nt'. For this individual assay, CEL I digestion time has been increased to optimize the internally-labelled approach, however, detection of the ~100nt cleavage fragment may not necessarily be improved simply by reducing digestion time, since increased background in the small size range will also result.

In summary, non-specific digestion of the end-labels results in significantly reduced signal from the cleaved amplicons (upper panel) compared to the result with internally labelled amplicons.

This new technique offers an increased degree of sensitivity in detection of mutations in specific genes in pooled samples, thereby enabling enlarged pool sizes to improve throughput and efficiency of the mutation scanning process. We are now investigating the limits of pool sizes in order to deliver a highly efficient mutation detection and analysis strategy for plant breeders and geneticists.

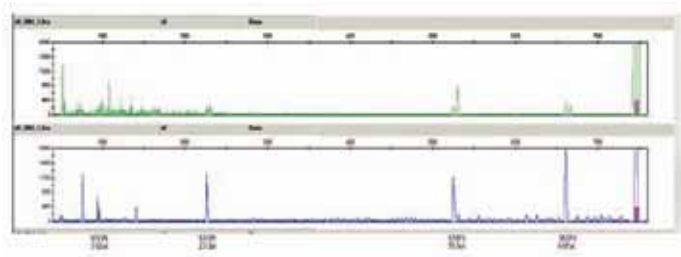

Figure 1 Comparisons of starch synthase IIa electropherograms of a pooled sample of rice genomic DNA digested with CEL I. The sample included two individuals with SNP mutations, detectable as cleavage fragments. The upper panel shows 5' end-labelled PCR products, whilst the lower panel shows the effect of internal labelling in increasing relative signal strength.

Practical implications

Previous work in our laboratories [4] demonstrated the improved detection of point mutations in polyploid sugarcane specimens by taking advantage of the sensitivity of capillary electrophoresis systems. This equated to fourteen-fold pooling due to the high ploidy level. Our research to date on the EMAIL technology has distinguished discrete SNP individuals in pools of 16 and we anticipate being able to perform routine detection in pools of at least 20. Developments in DNA sequenc-

ing have made sequencing the most cost-effective method for detection of most common mutations. However, the TILLING approach is an attractive option for discovery of rare alleles or mutations if large pools of individuals can be surveyed. EMAIL has now provided a protocol that has the capacity to meet this requirement and may prove to be the method of choice for the detection of rare mutations.

The advent of the EMAIL technique introduces a significant improvement in the efficiency of scanning pools of samples potentially containing point mutations in specific genes of interest. Furthermore, because of the degree of resolution of capillary electrophoresis, information is simultaneously obtained on the location of the mutation in the DNA sequence. Accordingly, the technique offers the plant breeder a new tool for the efficient screening of induced mutant populations at an early stage for variants in genes of interest before taking plants to field trial. It has the added advantage of providing information to assist the molecular characterization of mutations in genes of interest.

ACKNOWLEDGEMENTS

Grain Foods CRC Ltd. (Cooperative Research Centre) is acknowledged for financial support of this project.

BIBLIOGRAPHY

1. Comai, L., Henikoff, S. TILLING: practical single-nucleotide mutation discovery, *Plant J.* **45**, 684-694 (2006).
2. Caldwell, D.G., McCallum, N., Shaw, P., Muehlbauer, G.J., Marshall, D.F. Waugh, R. A structured mutant population for forward and reverse genetics in Barley (*Hordeum vulgare* L.). *Plant J.* **40**, 143-150 (2004).
3. Henikoff, S., Comai, L. Single-nucleotide mutations for plant functional genomics. *Ann. Rev. Plant Biol.* **54**, 375-401 (2003).
4. Cordeiro, G., Elliott, F.G., Henry R.J. An optimized ecotilling protocol for polyploids or pooled samples using a capillary electrophoresis system. *Anal. Biochem.* **355**, 145-147 (2006).
5. Comai, L., Young, K., Till, B.J., Reynolds, S.H, Greene, E.A., Codomo, C.A., Enns, L.C., Johnson, J.E., Burtner, C., Odden, A.R., Henikoff, S. Efficient discovery of DNA polymorphisms in natural populations by Ecotilling. *Plant J.* **37**, 778-786 (2004).
6. Sato, Y., Shirasawa, K., Takahashi, Y., Nishimura, M., Nishio, T. Mutant selection from progeny of gamma-ray-irradiated rice by DNA heteroduplex cleavage using Brassica petiole extract. *Breeding Science* **56**, 179-183 (2006).
7. Cross, M.J., Waters, D.L.E., Lee, L.S., Henry R.J. Endonucleolytic mutation analysis by internal labelling (EMAIL). *Electrophoresis* **29**, 1291-1301 (2008).
8. Waters, D.L.E., Henry, R.J., Reinke, R.F., Fitzgerald, M.A. Gelatinization temperature of rice explained by polymorphisms in starch synthase. *Plant Biotech. J.* **4**, 115-122 (2006).

DNA Sequence Analysis of Induced Mutants in Soybean

Kyujung Van¹ & Suk-Ha Lee^{1,2,*}

Abstract

Chemical mutagens, such as ethylmethanesulfonate (EMS), that cause point mutations were commonly used to induce mutations in both plants and animals due to the high frequency of heritable mutations. Saturated mutagenized populations could be generated with relatively few individuals. High-throughput genome sequencing is now available using the GS-20 or GS-FLX machines from Roche/454 Life Sciences, which are based on the advantages of emulsion PCR and pyrosequencing. Because of the wide availability of several high throughput genotyping methods, single nucleotide polymorphisms (SNPs) have drawn the attention of researchers. Degenerate oligonucleotide primed PCR (DOP-PCR) has been used for SNP genotyping in various organisms. In this study, we report the massive DNA sequence analysis of soybean mutants induced by EMS mutagenesis. Three soybean genotypes were used: 'Sinpaldalkong 2,' 'SS2-2' and '25-1-1.' Sinpaldalkong 2 is a recommended soybean variety in Korea and SS2-2 was generated by EMS mutagenesis of Sinpaldalkong 2. Genotype 25-1-1 is a regenerated M₃ plant from EMS-treated immature embryo culture of Sinpaldalkong 2. After genomic DNA from the three soybean genotypes was amplified with modified DOP-PCR, nucleotide sequences were determined using the GS-FLX. Assuming only orthologues show 100% identity in BLASTN, an average of 1,100 contigs and 7,000 singlets were formed in each soybean genotype. A total of 1,187 SNPs were detected, with a frequency as 1 SNP per 272bp, using POLYBAYES to survey sequence polymorphisms.

Introduction

Chemical mutagens, such as EMS, have been commonly used to induce mutations for forward genetics and enable saturated mutagenized populations to be assembled with relatively few individuals [1]. These chemical mutagens can be applied to many organisms [2-4]. The EMS treatment causes point mutations and any genome size is suitable for chemical mutagenesis by EMS [1, 5-7].

Several new 'next-generation' sequencing instruments, including GS-20 or GS-FLX from Roche/454 Life Sciences [8], Illumina's Solexa 1G sequencer [9], and the SOLiD system from Applied Biosystems (<http://solid.appliedbiosystem.com>), are available for high-throughput sequencing [10, 11]. The 454/Roche Genome Sequencers are based on emulsion PCR and pyrosequencing. They are used for various purposes. Initially, resequencing microbial genomes, studying phylogenetic relationships among microbial species and the identification of mutation sites in bacteria were performed with the 454/Roche platform [11-13]. Now, complicated large genomes are being studied for repetitive DNA and genomic copy number by high-throughput 454 sequencing [14, 15]. Many studies have been undertaken with maize using this Genome

Sequencer, such as the identification of polymorphic sequences with aligned cDNA transcriptome [16] and AFLP [17] and the detection of additional maize ESTs expressed in the shoot apical meristems collected via laser capture microdissection [18].

Point mutations, in the form of SNPs, can be used as molecular markers. These mutations of a single nucleotide have been studied extensively in both plants and animals following the recent availability of several high throughput genotyping methods [19-24]. Locus-specific primers were generally used for detecting these mutations, after comparing directly sequenced amplicons of individuals [25]. However, a new strategy, DOP-PCR, was used for SNP genotyping in human, mouse and *Arabidopsis thaliana* by massive DNA sequencing because of the requirement for sequence information and the high cost of designing primers for a limited number of SNPs [25-26].

Here we report the massive DNA sequence analysis of soybean mutants induced by EMS mutagenesis using the GS-FLX and DOP-PCR.

Materials and Methods

Three soybean genotypes were used: 'Sinpaldalkong 2,' 'SS2-2' and '25-1-1.' Sinpaldalkong 2 is a recommended soybean variety in Korea [27] and SS2-2 was generated by EMS mutagenesis of Sinpaldalkong 2 [28]. Genotype 25-1-1 is a regenerated M₃ plant from EMS-treated immature embryo culture of Sinpaldalkong 2. After genomic DNA from these three soybean genotypes was extracted [29], DOP-PCR was performed as described by Janiak et al. [25]. Amplified nucleotide sequences were determined using the GS-FLX.

Results and Discussion

Custom PERL scripts and the TGICL tool were used for trimming primers and alignment and assembly, respectively [30]. First, sequences were aligned and assembled, only if the aligned sequences showed 98% or 100% identity. Subsequently, we used only orthologues showing 100% identity to avoid possible inclusion of paralogous sequences. On average 1,100 contigs and 7,000 singlets were formed in each soybean genotype (Fig. 1).

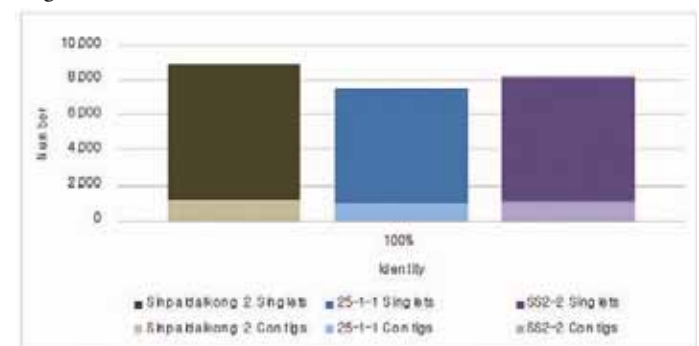

Figure 1 Number of singlets and contigs for each soybean genotype after alignments with sequences showing 100% identity.

¹ Department of Plant Science and Research Institute for Agriculture and Life Sciences, Seoul National University, Seoul, 151-921, Korea

² Plant Genomic and Breeding Research Institute, Seoul National University, Seoul, 151-921, Korea

* Corresponding author. E-mail: sukhalee@snu.ac.kr

Driving Forward in Reverse

T L Wang^{1,†}, J Perry¹, T Welham¹, J Pike³, M Parniske², C Rogers¹, G E D Oldroyd¹, P Stephenson¹, L Ostergaard¹, B Mccullagh¹, D Baker¹, S Walsh¹ & J Clarke¹

Abstract

We describe the use of TILLING in *Lotus japonicus* and the development of deletion (De)-TILLING in *Medicago truncatula*. The evolution of RevGenUK has been driven by the development of reverse genetics technologies in these two model legumes and *Brassica rapa*, which functions as a translational species for brassica crops. TILLING and De-TILLING are underpinned by populations of plants mutagenized with either EMS (that causes point mutations) or fast neutrons (that cause deletions), respectively. They permit the isolation of either allelic series of mutants or knockouts. Mutation detection will be developed from a number of independent gel-based systems to be carried out on a single platform – capillary electrophoresis. We are currently TILLING in both model legumes, but these developments will be applied to all three species. The resource will develop an open source database-driven system to support laboratory information management, analysis and the cataloguing of mutants in a genome context across all the species.

Introduction

We are currently experiencing a revolution in plant genomics since improvements to technologies and adoption of novel approaches have greatly reduced the cost of sequencing the genome of an organism. Assigning function, however, to the thousands of plant genes that have and will be discovered presents a major challenge to the research community. Reverse genetics allows the identification of plants carrying mutations in known genes and thereby provides the means to ascertain gene function by exploiting available genome sequences [1], [2].

Lotus japonicus TILLING

Several years ago, we set up the first reverse genetics TILLING platform in Europe [3] based on an EMS-mutagenised population of ca. 5000 plants of the model legume, *Lotus japonicus*, with help from the Seattle TILLING group. This platform consisted of pooled DNA samples from single M₂ plants representing each family in the whole population plus potential mutants isolated via forward screens for morphology, nodulation ability and starch content, plus a population for eco-TILLING [3], [4], [5]. The forward populations have been used as an enriched source of deleterious mutations. By the end of 2007, we had examined more than 150 gene targets for 20 collaborators representing 11 countries worldwide. On average, we have identified ca. 2 mutations per TILLed kb per 1,000 plants, equivalent to a mutation load of ca. one mutation per 0.5Mb (Table 1). This platform has allowed us to examine legume-specific processes in detail, especially the symbiosis with rhizobia. In several instances, however, we have been unable to recover homozygous plants for mutations that have been found; frequently they died at the seedling stage. This indicates that some genes may have a very important role in

plant growth and not one that is specific to symbiosis; loss of function in the nodule should not be lethal. In such circumstances, we can use the TILLING platform to isolate alleles that are not lethal and thus investigate gene function further. This is currently underway and demonstrates a major advantage of the TILLING platform over other types of reverse genetics that generate knockout mutants. Relying on TILLING alone for reverse genetics is limiting, since TILLING generates null alleles at a low frequency. As predicted for the original mutagen, 98% of all mutations caused G/C to A/T changes using our platform (Table 2), but this only mines a small proportion of the genome since of the 380 (20 amino acids x 19 alternatives) theoretical amino acid interconversions only 26 are possible through EMS mutagenesis [4]. Across all the fragments investigated, only ca. 5% of mutations identified lead to knockout mutants by causing premature stop codons or splicing abnormalities (Table 3) [4]. Hence, as a complement to TILLING, we have generated a novel reverse genetics platform initially in another model legume, *M. truncatula*. This platform utilizes deletions generated by fast-neutron (FN) mutagenesis and allows the identification of plants carrying deletions in target genes [6], [7]. Hence, TILLING and De-TILLING provide complementary reverse genetic platforms allowing reliable identification of allelic series and null mutants.

Table 1. Statistics of the *L. japonicus* TILLING population

Population	Total
Number of lines	4904
Number of genes TILLed	61
Number of fragments TILLed	84
Total fragment length TILLed [kb]	100
Non-overlapping fragment length TILLed [kb]	95.1
Number of mutations obtained	576
Mb screened ¹	294.6
Number of mutations per Mb ²	2
Mutation load [kb]	511

¹ Length of non-overlapping fragments multiplied with number of plants TILLed. ² Number of mutations obtained divided by length of non-overlapping fragments screened.

De-TILLING in *Medicago truncatula*

A major challenge to the identification of deletion mutants by PCR is overcoming the amplification of wild-type sequences to allow rare deletion-containing alleles to be preferentially amplified. Central to this platform, therefore, is our development of a detection strategy that allows a mutant amplicon, possessing an internal deletion, to be amplified in pools where the genomic target sequence is present at a 20,000-fold excess. This allows great efficiencies in time and cost in comparison to the standard eight-fold pooling of TILLING. This detection sensitivity has been achieved by combining two approaches that suppress the amplification of the undeleted wild-type fragment - restriction suppression and a

¹ John Innes Centre, Norwich NR4 7UH, UK

² Ludwig-Maximilian-Universitaet, D-80638 Munich, Germany

³ The Sainsbury Laboratory, Norwich NR4 7UH, UK

* Corresponding author. Email: trevor.wang@bbsrc.ac.uk

poison primer approach (Fig. 1). Restriction enzyme suppression relies upon the pre-digestion of highly complex DNA pools with a restriction enzyme which cuts once within the target sequence. This prevents a vast majority of the wild-type sequence from acting as a PCR template. This step relies on the fact that the deletion in the target gene will remove the restriction enzyme site and thus the deletion allele is protected from the restriction enzyme suppression. Wild-type target sequences escaping restriction enzyme suppression are subject to 'poison primer' suppression. In this strategy a third functional 'poison' primer is included in the first round of PCR. A shorter fragment, known as the suppressor fragment, is produced more efficiently and acts to suppress amplification of the longer fragment. Amplification from a mutant template present within the DNA pool, in which the poison primer-binding site has been deleted, produces a single amplicon from the external primers. Using a combination of poison primer and restriction enzyme PCR suppression we have been able to obtain detection sensitivities that allows us to screen very large pools of M_2 plants from which we can recover mutants carrying deletions in target genes [6]. Where conventional TILLING is carried out on pools of eight DNAs from individual plants, the De-TILLING platform has been optimized for the detection of a single heterozygous mutant in tower pools of 6,000 plants. Such a screening strategy is essential for exploiting fast neutron mutagenesis by reverse genetics because much larger populations of plants (50,000-100,000) are required compared to the EMS-populations required for TILLING (3,000-5,000). This is because the large deletions introduced by FN mutagenesis are tolerated at a much lower frequency than point mutations. Because there are fewer mutations per genome, however, much less clean up is required before the phenotype can be fully analyzed.

Table 2. Mutation types by nucleotide change detected in the TILLING population.

Change	G to A	C to T	other	Sum
Absolute number	298	264	14	576
Percentage of total	51.74	45.83	2.43	100

Table 3. Distribution of mutation types in the TILLING population

Mutation type ¹	Total mutants	HOM ¹	HET ¹	Ratio HOM:HET ¹
All	576	51	55	1:10
Missense	275	20	255	1:12
Stop	16	2	14	1:7
Splice	4	0	4	0
Deletion	0	0	0	0
Silent (intron)	163	16	147	
Silent (no aa change)	118	13	105	1:9

¹ HOM, homozygous mutants; HET, heterozygotes

Pooling lines of mutants to very high depths has the obvious advantage of reducing the amount of screening required. De-convolution of these pools, once a mutant has been detected can be time-consuming. To avoid this problem the De-TILLING platform employs a three-dimensional pooling strategy. The population is segregated into tower structures consisting of five 96-well plates of DNA extractions. Screening of the *M. truncatula* De-TILLING population is carried out on half tower pools, each representing 6,000 M_2 plants. Each tower is also pooled to create three-dimensional pools of rows, columns and plates. When a mutation is identified within a tower, these 25 pools can be screened simultaneously to identify a single seed lot within the tower in a single step. A population of 13 towers (156,000 M_2 plants) has now been established in *M. truncatula* at the JIC. A further population of around 20 towers has

also been established at the Noble Foundation, where there are plans to expand this population to 40 towers. We have focused on detecting deletions within 2-3kb PCR fragments. The screening that we have carried out on the JIC population alone indicates that we can recover mutants for 20% of targeted genes. Extrapolating this to the Noble population should allow a >50% recovery of knockout mutants for targeted genes.

The De-TILLING method can be used therefore, to isolate mutants at a fraction of the time of conventional TILLING. Fast neutron mutagenesis generates complete knockout mutants which possess a lower number of background mutations than those from TILLING platforms.

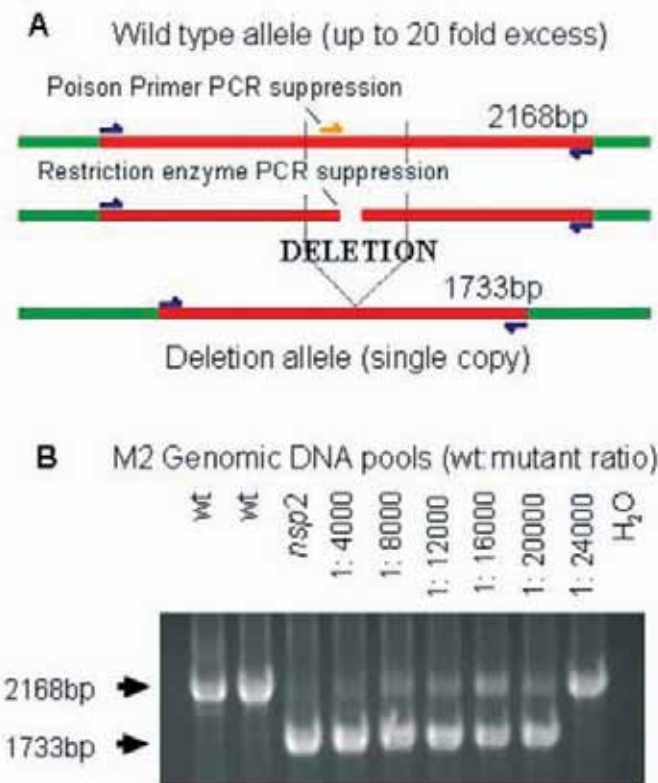

Figure 1 The De-TILLING deletion detection strategy. A. Amplification from a vast excess of wild-type sequences in DNA pools containing a deletion allele is suppressed by template restriction and production of the suppressor fragment from the poison primer. Amplification from an allele in which the restriction site and poison primer binding site is unaffected. B. A reconstruction experiment showing the amplification of the 435 bp deletion allele of *nsp2-1* in dilutions of wild-type genomic DNA. In the primary amplification only the relatively short poison primer product is visible. In a nested PCR the deletion allele is amplified from a pool of 20,000 wild-type genomes [6].

Fast neutron mutagenesis can also address the problems of targeting small genes as well as recovering mutations in tandemly duplicated genes, problems that are intrinsic to all methods based on insertion and point mutation. As the cost of sequencing continues to fall, the scalability, potential low cost and technical simplicity of fast neutron-based reverse genetics is likely to be exploited for a wide variety of plant species.

Investigating the rhizobium-legume symbiosis using TILLING

As mentioned above, we have made extensive use of reverse genetics to investigate symbioses. In recent years, our understanding of the root nodule symbioses has advanced considerably. Much detail has been added by map-based cloning of forward screened mutants and by reverse genetics using both RNAi and mutants isolated using our TILLING platform. Receptor-kinases (NFR1, NFR5 and SYMRK), ion channels (CASTOR and POLLUX), a nucleoporin (NUP133) and nuclear proteins (CCaMK, CYCLOPS, NIN, NSP1 and NSP2) are all involved (Fig. 2; see [8, 9][8] for further details), although the interplay between these

genes has not been established. Some of the genes for which we are currently undertaking TILLING with collaborators will help to elucidate the mechanisms involved. In *L. japonicus* serine/threonine receptor kinases recognize properly decorated rhizobial lipochitin-oligosaccharide signal molecules at their extracellular LysM domains and initiate the signal transduction cascade resulting in dedifferentiation of cortical cells and initiation of cytokinin-stimulated cell divisions (that establish the nodule meristem), organ formation and invasion of the organ tissue by the microsymbiont. To date, we have isolated mutants in a number of key components of the signaling pathway that lead to the formation of a nodule as shown in Fig. 2 (see also [4]).

As the nodule is formed, bacteria re-differentiate to form bacteroids that rely on the plant for all their nutrients, in return supplying fixed atmospheric nitrogen to the plant. Carbon is obtained via the breakdown of sucrose either by sucrose synthase or invertase as these are the only enzymes that carry out this process in plants. The carbon is believed to enter bacteroids in the form of dicarboxylic acids. Since the TILLING platform permits targeting of specific isoforms, it was also used to isolate mutants including null alleles for two of the family of six sucrose synthases in *L. japonicus* that are the main ones present in the nodule. Analyses of these lines demonstrated that both isoforms were required for nitrogen fixation and assimilation in *L. japonicus*; only double mutants that knocked out both genes were unable to assimilate nitrogen via their nodules [11].

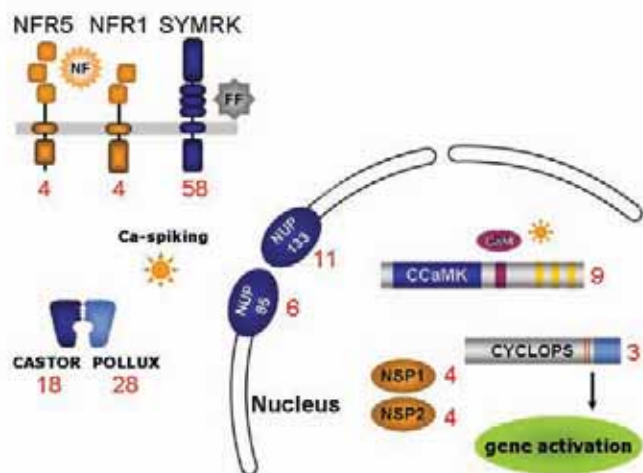

Figure 2 Components of the legume-rhizobium symbiosis signaling pathway in *Lotus japonicus*. Numbers in red after each component are the number of mutant alleles obtained by TILLING to date (see [8], [9], [10] for further details of genes.)

RevGenUK

There is an increasing demand for mutant alleles in conventional breeding programmes. TILLING and De-TILLING strategies provide an alternative to transgenic approaches. Using these technologies as the main pillars, in May 2008 we launched a 'single-stop' shop for use in functional genomics research based around the EMS and FN populations of *L. japonicus*, *M. truncatula* and *B. rapa* and a single capillary electrophoresis platform. It is hoped that the platform (*RevGenUK*), supported by the UK's Biotechnology and Biological Sciences Research Council, will eventually provide TILLING and De-TILLING services across three model species: our two legumes and *B. rapa*; initially only TILLING in the model legumes is being offered to the community. The platform will also have a web-accessible informatics capability and be of sufficient flexibility to allow for future expansion as the research community demands.

ACKNOWLEDGEMENTS

We should like to thank the Biotechnology and Biological Sciences Research Council for their continuing support of *L. japonicus* and *B. rapa* TILLING and for their support of *RevGenUK*. We should also like to thank the EU Framework 6 project 'Grain Legumes Integrated Project' (GLIP; FOOD-CT-2004-506223), for supporting the development of *M. truncatula* TILLING and De-TILLING.

BIBLIOGRAPHY

1. Østergaard, L., Yanofsky, M. Establishing gene function by mutagenesis in *Arabidopsis thaliana*. *Plant Journal* **39**, 682 (2004).
2. Alonso, J., Ecker, J. Moving forward in reverse: genetic technologies to enable genome-wide phenomic screens in *Arabidopsis*. *Nature Reviews Genetics* **7**, 524 (2006).
3. Perry, J. *et al.* A TILLING reverse genetics tool and a web-accessible collection of mutants of the legume *Lotus japonicus*. *Plant Physiology* **131**, 866 (2003).
4. Perry, J. *et al.* TILLING in *Lotus japonicus* identified large allelic series for symbiosis genes and revealed a bias in non-functional alleles towards hits in glycine codons. *Plant Physiology* (submitted).
5. Comai, L. *et al.* Efficient discovery of DNA polymorphisms in natural populations by EcoTilling. *Plant Journal* **37**, 778-86 (2004).
6. Rogers, C., Oldroyd, G.E.D. Fast neutron mutagenesis for functional genomics. In: *The Handbook of Plant Functional Genomics* (Kahl, G., Meksem, K., Eds.), Wiley-VCH, Weinheim, 291-306 (2008).
7. Li, X. *et al.* A fast neutron deletion mutagenesis-based reverse genetics system for plants. *Plant Journal* **27**, 235 (2001).
8. Oldroyd, G.E.D., Downie, J.A. Coordinating nodule morphogenesis with rhizobial infection in legumes. *Annual Reviews of Plant Biology* **59**, 519 (2008).
9. Yano, K. *et al.* CYCLOPS, a mediator of symbiotic intracellular accommodation. *Proceedings of the National Academy of Sciences* **105**, 20450-20545 (2008).
10. Parniske, M. Arbuscular mycorrhiza: the mother of all endosymbioses. *Nature Reviews Microbiology* **6**, 763-775 (2008).
11. Horst, I. *et al.* TILLING mutants of *Lotus japonicus* reveal that nitrogen assimilation and fixation can occur in the absence of nodule-enhanced sucrose synthase. *Plant Physiology* **144**, 806-820 (2007).

CONCURRENT SESSION 8

Mutation Induction and Breeding of Ornamental and Vegetatively Propagated Plants

A Report on 36 Years of Practical Work on Crop Improvement Through Induced Mutagenesis

S K Datta*

Abstract

Induced mutagenesis work was conducted from 1971 to July 2007, using both physical and chemical mutagens for improvement of a wide range of crops viz. vegetables, medicinal, pulse, oil-bearing, and ornamental crops. All classical and advanced methods were extensively used for the success of induced mutagenesis for the development of new and novel cultivars of economic importance. Being deeply engaged for the last 30 years on improvement of ornamentals through Gamma-ray induced mutagenesis, I have produced a large number of new and promising varieties in different ornamentals. A good number of ornamental mutant varieties have already been commercialized. A novel technique has been developed for management of floral chimeric sector in chrysanthemum through direct regeneration of mutated individual florets. A series of *in vitro* experiments were conducted and solid mutants developed through direct regeneration. *In vitro* mutagenesis has been successfully used for development of a salt-resistant strain in chrysanthemum, supported by biochemical analysis and field trials.

Introduction

Physical and/or chemical mutagens cause random changes in the nuclear DNA or cytoplasmic organelles, resulting in gene, chromosomal or genomic mutations. Induced mutagenesis is an established method for plant improvement, whereby plant genes are altered by treating seeds or other plant parts with chemical or physical mutagens. Voluminous work has been done worldwide for the improvement of both seed and vegetatively propagated crops through induced mutation. In the present paper, I will highlight important results of induced mutagenesis work carried out for the last 36 years, on both seed and vegetatively propagated crops. Appreciable knowledge and literature have been generated during 36 years of practical experiments on crop improvement using classical and modern induced mutagenesis techniques on aspects like radio-sensitivity, selection of material, methods of exposure to mutagens, determination of suitable dose of mutagen, combined treatment, recurrent irradiation, split dose, colchi-mutation, detection of mutation, mutation frequency and spectrum of mutations, nature of chimerism, classical and modern methods for management of chimera, *in vitro* mutagenesis, isolation of mutants, cytological, biochemical and molecular characterization of mutants, commercial exploitation of mutant varieties, etc.

Materials and Methods

Experimental materials

Crops selected as experimental materials included vegetables (*Trichosanthes anguina* L., *T. cucumarina*, *Cucurbita maxima* L., *Cephalandra indica*, *Luffa acutangula* Roxb., *Lagenaria ciceraria*),

medicinal plants (*Trigonella foenum-graecum* L., *Mentha citrata* Ehrh), pulses (Winged Bean - (*Psophocarpus tetragonolobus* L. D.C.), oil-bearing crops (*Jatropha curcas* L., *Rosa damascena*, *Cymbopogon flexuosus* (Nees) Wats) and ornamentals (Amaryllis, Asiatic Hybrid Lily, Bougainvillea, Canna, Chrysanthemum, Dahlia, Gerbera, Gladiolus, Hibiscus, *Lantana depressa* Naud, *Tagetes erecta*, Rose, Tuberose, *Narcissus tazetta* etc.).

Mutagen and treatment methodology

Both physical (X-rays and Gamma-rays) and chemical (EMS, MMS, Colchicine) mutagens were used for improvement programmes (Table 1).

Table 1. Crops where mutation breeding was performed, mutagens used and treatments applied

Crop	Propagule	Mutagens	Dose	Treatment	
<i>T. anguina</i>	Dry seeds	X-rays	6–30 kR	[for 18 hrs]	
		Colchicine	0.25–1.00%		
<i>T. cucumarina</i>	Dry seeds	X-rays	6–30 kR	[for 18 hrs]	
		Colchicine	0.25–1.00%		
<i>C. indica</i>	Dry seeds	X-rays	6–48 kR	[for 18 hrs]	
		Colchicine	0.25–1.00%		
<i>C. maxima</i>	Dry seeds	X-rays	6–30 kR	[for 18 hrs]	
		Colchicine	0.25–1.00%		
<i>L. siceraria</i>	Dry seeds	Colchicine	0.25–1.00%	[for 6 hrs]	
<i>L. acutangula</i>	Dry seeds	Colchicine	0.25–1.00%	[for 6 hrs]	
<i>T. foenum-graecum</i>	Dry seeds	Gamma-rays	30–50 Krad	[for 6 hrs]	
		2hrs H ₂ O soaked seeds	MMS		0.02–0.06%
		EMS	0.3–0.6%		
<i>M. citrata</i>	Rooted cuttings	Gamma-rays	2–8 Krad		
<i>P. tetragonolobus</i>	Dry seeds	Gamma-rays	10–30 Krad		
<i>J. curcas</i>	Dry seeds	Gamma-rays	6–24 Krad		
		Colchicine	0.25–1.00%		
<i>R. damascena</i>	Stem cuttings	Gamma-rays	1–2Krad	[for 18 hrs]	
Ornamentals					
Amaryllis	Bulb	Gamma-rays	250rads-5 Krad		
Bougainvillea	Stem cuttings		250–1250 rads		
Canna	Rhizome		2 and 4 Krad		
Chrysanthemum	Rooted cuttings/suckers		1.0 -3.5 Krad		
Gerbera	Rooted plantlet		1 and 2 Krad		
Gladiolus	Bulb		250 rads–5 Krad		
Hibiscus	Stem cuttings		1.0–4 krad		
<i>Narcissus tazetta</i>	Bulb		250,500,750 rad		
<i>Perennial portulaca</i>	Stem cuttings		250–1250 rads		
<i>Polianthus tuberosa</i>	Bulb		250 rad–8 Krad		
Rose	Stem with budding eyes		2–6 Krad		
<i>Tagetes erecta</i>	Rooted cuttings		500 rad–2 Krad		
<i>Lantana depressa</i>	Stem cutting		1–4 Krad		

4/184, Vivek Khand, Gomti Nagar, Lucknow-226010, U.P., India. Retired Deputy Director and Head, Floriculture Section, National Botanical Research Institute, Lucknow, India.

* Present address: CSIR, Emeritus Scientist, Madhyamgram Experimental Farm, Acharya J. C. Bose Biotechnology Innovation Center, Bose Institute, Jessore Road, Madhyamgram, 24-Parganas (N), Kolkata 700129, India. E-mail: subodhskdatta@rediffmail.com; subodhskdatta@yahoo.com

Combined treatment

Dry seeds of *T. anguina* were first treated with 24 and 30 kR X-rays and then kept immersed in 0.25, 0.50 and 1.00% aqueous solution of colchicines for 18 hours.

Treated seeds were sown in the field in randomized block design beds for biological assessment.

In vitro culture

Chimeric florets (developed through sport or gamma irradiation) were cultured for direct regeneration on MS medium [1, 2].

Results

Oil bearing crops

Both tall and dwarf, high-branching, high fruit and oil yielding and high biomass yielding variants were induced in *J. curcas*, the seed oil ("Curcas Oil"), an efficient substitute fuel for diesel engines [3, 4]. Gamma radiation was also found to be effective to induce suitable strains of *J. curcas* for growing on alkali soil [5]. Genetic variability in different morphological and agronomical characters could be induced in the essential oil-bearing plant *Cymbopogon flexuosus* [6]. *Rosa damascena* or Damask rose, which contains essential oil considered to be the best, was found to be very sensitive to gamma radiation and variability could be induced in different morphological characters. The original flower color of *R. damascena* was light pink, while one plant in 1Krad treated population showed white flowers. The mutant has been isolated and established in pure form [7].

Pulse crops

A dwarf mutant with determinate growth habit has been developed in Winged Bean, this trait being highly economic to solve staking problems in cultivation [8]. An early fruiting mutant has also been isolated from the Gamma-ray-treated population [9].

Medicinal crops

Response of *M. citrata* to gamma radiation was very promising in developing hairy mutants and mutants with higher herbage yield [10]. Gamma-rays, EMS and MMS were most successful in developing a series of mutants of economic importance in *T. foenum-graecum*, an important condiment, medicinal and fodder cum green vegetable crop. Mutants with small seeds, bold seeds, green and chocolate seed coat color against normal green, dwarf and high-branching, etc., were induced. Interestingly, a number of mutants with phylogenetic significance could be isolated. Mutants with uni to octa-foliolate leaflets were developed against normal tri-foliolate leaflets, playing a relevant role in understanding phylogenetic affinities [11-17].

Vegetable crops

Fruits of *T. anguina* are used as a summer vegetable. Its seeds also yield a kind of drying oil. One of the essential constituents of this oil is punicic acid, which is an isomer of alpha-oleostearic acid of tung oil. Mutants have been induced and isolated with promising and economic early flowering, short thick fruits, increased fruit weight, yellow fruits, high oil and punicic acid yield, crinkled leaves etc. [18-26].

Promising genetic variability in different economic characters could also be induced by X-rays in *C. maxima*, *L. siceraria*, *C. indica* and *T. cucumarina* [27-28].

Ornamental crops

Classical mutagenesis

Extensive work has been carried out for the last 30 years for improvement of different ornamental crops. The main objective was to develop new and novel varieties for floriculture trade. Large numbers of studies on mutagenesis in ornamental plants by using physical and chemi-

cal mutagens has been carried out in both applied and basic aspects. Gamma-rays have been most successfully used and 76 new mutant varieties with changed flower color/shape, and chlorophyll variegation in leaves have been developed and released in different ornamentals. Voluminous information has been generated on various basic aspects for successful application of classical mutagenesis. Work by the author on exploitation of mutagenesis for improvement of different ornamentals has been reported separately (IAEA-CN-167-283P).

Management of chimera and in vitro mutagenesis

The main bottleneck of induced mutation with vegetatively propagated crops is the formation of chimera. Chimeric tissues cannot be isolated using the available conventional propagation techniques. Both *in vivo* and *in vitro* techniques have been standardized for management of chimera. A novel technique has been standardized for the management of such chimeric tissues through direct shoot regeneration from flower petals. The technique has been standardized and a series of new solid flower color/shape mutants have been developed in chrysanthemum using *in vitro* mutagenesis through direct regeneration of mutated cells in florets without diplontic selection. These aspects are reported separately (IAEA-CN-167-284P).

Recently, systematic efforts have been made to develop trait-oriented mutation. Efforts were made to develop NaCl-tolerant chrysanthemum plants through *in vitro* mutagenesis. One such NaCl-tolerant chrysanthemum variant has been developed in a stable form through whole plant selection in *in vitro* mutagenesis using ethylmethane sulfonate (EMS) as the chemical mutagen [29-30]. Data reflects that a proper balance between enzymatic and non-enzymatic defence system is required for combating salinity stress in chrysanthemum. A better performance of the progeny of selected lines under the same salinity stress condition, even in the second year, confirmed the genetic stability of the salt-tolerance character. In a separate experiment, an attempt was made to develop stable NaCl-tolerant chrysanthemum plants by selection of a NaCl-tolerant callus line and subsequent differentiation under NaCl stress [31]. Enhanced tolerance of the variants was attributed to an increased activity of superoxide dismutase, ascorbate peroxidase, and dehydroascorbate reductase, and, to a lesser extent of membrane damage than NaCl-treated control plants. Salt tolerance was evaluated by the plant capacity to maintain both flower quality and yield under stress conditions. It has been concluded that a stepwise increase in NaCl concentration from a relatively low level to a cytotoxic level was a better way to isolate NaCl-tolerant callus lines, since direct transfer of callus to high saline medium was detrimental to its survival and growth [32].

More recently, attempts have been made to regenerate chrysanthemum plants from single cells, i.e. through somatic embryogenesis, for a management of single cell mutation events. An efficient somatic embryogenesis protocol has been standardized in chrysanthemum, which will open up a new way for isolating new flower color/shape ornamental cultivars through retrieval of single mutated cells [33].

Combined effects

Radiation induced genetic and physiological damages, and mutation frequency can be modified and influenced by pre and post-irradiation treatment of seeds with chemicals. Combined effects of mutagens i.e. post x-irradiation colchicine treatment were studied in *T. anguina*. Protective effects were estimated in combined treated population to reduce the damages caused by individual mutagens [34-35].

Colchi-Mutation

Colchicine was found to be very effective to induce genetic variability in *L. acutangula*, *L. siceraria* [36], *C. maxima* [18], *T. anguina* and *T. cucumarina* [18, 25]. High fruit, seed, oil and punicic yielding mutants were isolated from a colchicine-treated population of *T. anguina* [25].

Successful application of colchicine to induce somatic flower color mutations in vegetatively propagated ornamentals (Chrysanthemum and Rose), are reported separately in this volume (IAEA CN-167-283P).

Analysis of colchi-mutants (developed both in seed and vegetatively propagated crops), clearly indicated that instead of inducing complete polyploidy in the plant, colchicine produced gene mutations in both the presently experimental seed and vegetatively propagated plants. It may be pointed out that, normally, after colchicine treatment, attention is paid to chromosome duplication and its effect on phenotype. When there is no polyploid formation and when there are no gigantism in desired characters in induced polyploid in particular taxa, colchicine breeding is thought to be unsuccessful. But careful observations have led to the understanding that although colchicine is known more familiarly as a polyploidizing agent, it may also be used as a very good mutagen (37).

Domestication

It is commonly accepted that domestication of wild species has been conditioned by mutation following selection. *L. depressa* (Verbenaceae) is a semi-wild herb with creeping habit and yellow flowers with little genetic variability. It is grown on roadsides and borders of gardens for decoration. Gamma-rays have successfully induced one chlorophyll-variegated mutant i.e. *L. depressa* 'variegata', and two flower color mutants (one canary yellow – 'Niharika', and another yellow and white bicolored – *L. depressa* bicolored). These mutants are very attractive and can be grown as potted ornamentals, supporting the concept that induced mutagenesis can also be used as an efficient technique for domestication [38].

Radiosensitivity

The study of radiosensitivity is a prerequisite for large-scale mutation breeding work. A wide range of parameters known to influence radiosensitivity were studied to determine the radiosensitivity and their correlation, including nuclear factors (chromosome number and size, centromere number and position, Interphase Chromosome Volume, Interphase Nuclear Volume, degree of polyploidy, nuclear DNA content etc.), seed moisture content, seed size, seed coat, flower type, flower color, flower shape, etc. Direct, fractionated dose and storage effects of Gamma-rays on radiosensitivity were studied. Radiobiological responses of a large number of plant species clearly indicated that radiosensitivity varies according to the propagules. Different cultivars were differentially sensitive to gamma radiation, and it is very clear that radiosensitivity is a genotype-dependent mechanism [39-42].

Discussion

These results and those available elsewhere in the literature, clearly show that mutation by using both physical and chemical mutagens has successfully produced quite a large number of new and promising varieties in different seeds and ornamental plants, and is considered to be a most successful tool for breeding ornamental plants [43-46]. The main advantage of mutation induction in vegetatively propagated crops is the ability to change one or a few characters of an otherwise outstanding cultivars without altering the remaining and often unique part of the genotype [47]. Mutation breeding has been more successful in ornamental plants because changes in any phenotypic characteristics like color, shape or size of flower and chlorophyll variegation in leaves can be easily detected. In addition, the heterozygous nature of many ornamentals offers high mutation frequency. The capability of Gamma-rays in inducing desirable mutations in ornamental plants is well understood from a significant number of new varieties developed via direct mutation breeding. Recent genetic engineering techniques appear to be most promising and exciting for development of desirable transgenic ornamentals, but this technology is at the early stage of development. Every technique has its own advantages and disadvantages. After more than three decades of applied mutagenesis work, it is established beyond doubt that mutation breeding

will constitute an excellent supplement to the conventional methods in practice. Studies have clearly proved that mutation breeding techniques using nuclear radiation can be exploited for the creation of new and novel ornamental cultivars of commercial importance, by inducing genetic variation in already adapted, modern genotypes and can also enrich the germplasm of ornamental horticulture. Although mutation breeding is a random (chance) process, reports are available for directive mutation in flower color with some starting colors [48]. Mutation breeding at its present status appears to be well standardized, efficient and cost-effective. Classical mutagenesis combined with management of chimera and *in vitro* mutagenesis are most promising and standardized techniques for developing new and novel varieties. Voluminous practical knowledge generated by the author on basic and applied aspects for successful application of induced mutagenesis for improvement of seed and vegetatively propagated crops has been published in the form of research papers (258), review papers (13), book chapters (29), books (2), edited books (4), bulletins (8), popular articles (78), Symposium abstracts (123), etc.

ACKNOWLEDGEMENT

Thanks are due to the Director of the National Botanical Research Institute, Lucknow, India for providing the facilities. Thanks are also due to the Director, Bose Institute, Kolkata and Council of Scientific and Industrial Research, New Delhi for present association of Dr. S. K. Datta with the institute as CSIR, Emeritus Scientist.

BIBLIOGRAPHY

- Murashige, T., Skoog, F.A. revised medium for rapid growth and bio-assays with tobacco tissue cultures. *Physiol. Plant* **15**, 473-497 (1962).
- Chakrabarty, D. *et al.* Management of chimera through direct shoot regeneration from florets of chrysanthemum (*Chrysanthemum morifolium* Ramat.). *J. Hort. Sci. Biotechnol* **74**, 293-296 (1999).
- Datta, S.K., Pandey, R.K. Improvement of *Jatropha curcas* through induced mutations. *J. Ind. Bot. Soc.* **71**(I-IV), 213-215 (1992).
- Pandey, R.K. Cytogenetical studies in *Jatropha curcas* Linn., Ph.D. thesis, Avadh University, Faizabad, India (1995).
- Datta, S.K. *et al.* Performance of mutagen treated *Jatropha curcas* (Petro crop) on alkali soil. *J. Nuclear Agric. Biol.* **27**(3), 165-171 (1998).
- Banerji, B.K. *et al.* Karyomorphological studies in *Cymopogon flexuosus* (Nees) Wats. *Bangladesh J. Bot.* **16**(1), 109-110 (1987).
- Gupta, M.N. *et al.* Effects of gamma irradiation on *Rosa damascena* Mill. *The Indian Rose Annual.* **11**, 55-61 (1988).
- Jugran, H.M. *et al.* Gamma-ray induced dwarf mutant of winged bean *Psophocarpus tetragonolobus* (L.) D.C. *J. Nuclear Agric. Biol.* **15**(3), 175-178 (1986).
- Jugran, H.M. *et al.* Gamma-ray induced early fruiting mutant in Winged Bean *Psophocarpus tetragonolobus* (L.) DC. *Journal of Nuclear Agriculture & Biology.* **30**(2), 116-119 (2001).
- Gupta, M.N. *et al.* Effects of Gamma-rays on *Mentha citrata* Ehrh. *Indian Perfumer XXIII* **1**, 42-46 (1979).
- Laxmi, V. *et al.* Studies on the induced morphological mutants of fenugreek: stem fasciation. *J. Nuclear Agric. Biol.* **11**(2), 59-61 (1982).
- Laxmi, V. *et al.* A methyl methane sulphonate induced mutant of Fenugreek. *SABRAO Journal* **14**(1), 83 (1983).
- Laxmi, V. *et al.* Investigations on an induced green seed coat color mutant of *Trigonella foenumgraecum*. *Cytologia* **48**, 473-78 (1983).
- Laxmi, V., Datta, S.K. Gamma-ray induced small seeded mutant of Fenugreek. *J. Nuclear Agric. Biol.* **15**(3), 183-184 (1986).
- Laxmi, V., Datta, S.K. Chemical and physical mutagenesis in Fenugreek. *Biological Memoirs.* **13**(1), 64-68.
- Laxmi, V., Datta, S.K. Induced mutations of phylogenetic significance in Fenugreek. *Legume Research* **12**(2), 91-97 (1989).
- Datta, S.K., Laxmi, V. Induced morphological mutations in Fenugreek. *J. Ind. Bot. Soc.* **71**(I-IV), 65-68 (1992).

18. Basu, R.K., Datta, S.K. Effects of X-rays and cochicine on pollen of *Trichosanthes anguina* L. (Cucurbitaceae). *Grana* **16**, 105-109 (1977).
19. Datta, S.K., Basu, R.K. Abnormal plant growth in M₁ and C₁ generation of two species of *Trichosanthes*. *Trans. Bose Res. Inst.* **40**(3), 63-67 (1977).
20. Basu, R.K., Datta, S.K. Sensitivity of two species of *Trichosanthes* to X-ray and colchicine. *J. Cytol. Genet.* **17**, 107-112 (1982).
21. Datta, S.K. Studies on an X-ray induced crinkled leaf mutant of *Trichosanthes anguina* L. *J. Nuclear Agric. Biol.* **15**(2), 120-124 (1986).
22. Datta, S.K. Studies on an X-ray induced yellow fruit mutant of *Trichosanthes anguina*. *Crop Improvement* **14**(2), 182-184 (1987).
23. Datta, S.K. Induced high punicic acid yielding mutants of *Trichosanthes anguina* L. *J. Indian Bot. Soc.* **68**, 44-46 (1989).
24. Datta, S.K. Induction and analysis of early flowering mutants in *Trichosanthes anguina* Linn. *Biological Memoirs* **15**(1), 18-22 (1989).
25. Datta, S.K. Effects of X-rays and colchicine on fruit and seed yield of *Trichosanthes anguina* L. *J. Indian Bot. Soc.* **70**(I-IV), 401-402 (1991).
26. Datta, S.K. Induction and analysis of short thick fruit mutant *Trichosanthes anguina* L. *Indian J. Genet. & Pl. Breed.* **54**(1), 13-17 (1994).
27. Datta, S.K. Studies in *Cephalandra indica* Naud. *Cytologia* **53**, 731-737 (1988).
28. Datta, S.K. Studies on *Cucurbita maxima* L. *Prog. Hort.* **15**(1-2), 112-115 (1983).
29. Hossain, Z. *et al.* Isolation of a NaCl-tolerant mutant of *Chrysanthemum morifolium* by gamma radiation: *in vitro* mutagenesis and selection by salt stress. *Functional Plant Biology* **33**, 91-101 (2006).
30. Hossain, Z. *et al.* Development of NaCl-Tolerant strain in *Chrysanthemum morifolium* Ramat. through *in vitro* mutagenesis. *Plant Biology* **8**(4), 450-461 (2006).
31. Hossain, Z. *et al.* Development of NaCl-tolerant strain in *Chrysanthemum morifolium* Ramat. through shoot organogenesis of selected callus line. *Journal of Biotechnology* **129**, 658-667 (2007).
32. Hossain, Z *et al.* NaCl stress – its chromotoxic effects and antioxidant behavior in roots of *Chrysanthemum morifolium* Ramat. *Plant Science* **166**, 215-220 (2004).
33. Mandal, A.K.A., Datta, S.K. Direct somatic embryogenesis and plant regeneration from ray florets of chrysanthemum. *Biologia Plantarum* **49**(1), 29-33 (2005).
34. Datta, S.K., Basu, R.K. Modifications of chromosomal aberrations and polyploidy by combined treatment with X-rays and colchicine in *Trichosanthes anguina*. *Indian Biologist X1*, 59-64 (1978).
35. Datta, S.K. Assessment of single and combined X-ray and colchicine treatment of *Trichosanthes anguina* L. *J. Nuclear Agric. Biol.* **21**(4), 293-298 (1992).
36. Datta, S.K. Study of effects of colchicine in *Luffa acutangula* Roxb. and *Lagenaria siceraria* in relation to germination and polyploidy production. Bangladesh. *J. Botany* **7**(1), 59-64 (1978).
37. Datta, S.K. Colchicine induced mutations in seed and vegetatively propagated plants. *J. Indian Bot. Soc.* **69**, 261-266 (1990).
38. Datta, S.K. Induced mutation for plant domestication : *Lantana depressa*. *Proc. Indian. Sci. Acad.* **B61 No. 1**, 73-78 (1995).
39. Datta, S.K. *et al.* Radiosensitivity -A genotype dependendent mechanism. *J. Nuclear Agric. Biol.* **20**(3), 169-174 (1991).
40. Datta, S.K. Radiosensitivity of garden chrysanthemum. *J. Ind. Bot. Soc.* **71**(I-IV), 283-284 (1992).
41. Banerji, B.K., Datta, S.K. Varietal differences in radiosensitivity of garden chrysanthemum. *The Nucleus* **36**(3), 114-117 (1993).
42. Hossain, Z. *et al.* Direct, fractionated dose and storage effects of Gamma-rays on radiosensitivity of resting and dividing cells of onion. *J. Nuclear Agric. Biol.* **31**, 3-4 183-188 (2002).
43. Micke, A. Induced mutations for crop improvement. *Gamma Field Symposium* **30**, 1-21 (1991).
44. Maluszyski, M. *et al.* Application of *in vivo* and *in vitro* mutation techniques for crop improvement. *Euphytica* **85**, 303-315 (1995).
45. Datta, S.K. Ornamental plants- Role of mutation. Daya Publishing House, Delhi, p. 219 (1997).
46. Datta, S.K. Induction and analysis of somatic mutations in vegetatively propagated ornamentals. D.Sc. Thesis, Kanpur University, Kanpur, India (1992).
47. Broertjes, C., Van Harten, A.M. Applied mutation breeding for vegetatively propagated crops. Elsevier, Amsterdam (1988).
48. Datta, S.K. Role of mutation breeding in inducing desired genetic diversity in ornamentals for the floriculture trade. Proc. Symp. Induced Mutations and Molecular Techniques for Crop Improvement, jointly organized by IAEA and FAO, 19-23 June, 670-672 (1995).

Citrus Improvement Using Mutation Techniques

E S Louzada

Citrus cultivar improvement is hampered by several biological factors inherent to most citrus species. Facultative apomixis, self and cross-incompatibility, long juvenility period, and high heterozygosity are some of the vast arrays of impediments faced by citrus breeders in conventional hybridization.

Since oranges and grapefruits are highly polyembryonic, the production of enough numbers of zygotic offspring for selection of superior genotypes of these species is basically impossible; hence, most commercially important cultivars of these species have originated through natural or induced mutation. Star Ruby, a deep-red-fleshed grapefruit, was developed by irradiation of Hudson grapefruit seeds with thermal neutrons [1]. Unlike Hudson, which contains over 50 seeds per fruit, Star Ruby is nearly seedless. Hensz [2] irradiated buds of Ruby Red grapefruit with thermal neutrons and a tree that originated from one of the buds produced fruits three times redder than Ruby Red. It was named A&I-1-48. Ten trees were propagated from A&I -1-48, and out of one of the trees, a budsport mutation was found producing fruits five times redder than Ruby Red. Called Rio Red, it is currently the variety of choice for Texas and is known worldwide for its sweetness, red flesh and beautiful blush. Currently, 37 years after A&I -1-48 was first propagated, the trees are still producing several budsport mutations. So far, in the 2007/2008 season, more than 100 new mutations were obtained from a 100-tree block.

In the mandarin group, the existence of several monoembryonic cultivars facilitates conventional breeding, but still, induced mutation is part of most mandarin breeding programmes, and proprietary, new seedless cultivars have been produced in the US, Italy, Israel and elsewhere [3, 4, 5, 6]. Seedless mandarins produced by the University of California Riverside include Dayse, Fairchild, Encore, and Nova. The USDA-ARS, U.S. Horticultural Research Laboratory in Florida released a seedless Pineapple orange, and the University of Florida a seedless Murcot tangor.

Mutation has been also important in lemon breeding, and a seedless lemon, with tolerance to a devastating lemon disease was recently reported [7], in addition to earlier reports of a thornless lemon mutant produced by gamma irradiation [8].

Gamma irradiation is currently an important component of our breeding programme and several potentially improved cultivars of grapefruit, pummelos, and lemons are in the pipeline. Additional details of citrus irradiation programmes in the US will be provided.

BIBLIOGRAPHY

1. Hensz, R.A. Mutation breeding and the development of the 'Star Ruby' grapefruit. *Proc. Int. Soc. Citriculture* **2**, 582-585 (1977).
2. Hensz, R.A. 'Rio Red', a new grapefruit with a deep-red color. *J. Rio Grande Valley Hort. Soc.* **38**, 75-76 (1986).
3. Du Plooy C.P., Steenekamp, P.J., Vincent, A.P. Human, C.F., Koekemoer, P.J.J. Mutation breeding strate GY for citrus in South Africa. *Proc. Int. Soc. Citriculture* **1**, 110-112 (1992).
4. Froneman, I.J., Breedt H.J., Koekemoer P.J.J., Van Rensburg P.J.J. Producing seedless citrus cultivars with gamma irradiation. *Proc. Int. Soc. Citriculture* **1**, 159-163 (1996).
5. Russo, F. Donini, B., Starrantino, A. Mutation applied for citrus improvement. *Proc. Int. Soc. Citriculture* **1**, 68-70 (1981).
6. Starrantino, A., Mannino, P. and Russo, F. The genetic stability of three seedless clonal selections obtained by gamma rays of the seedy 'Monreal' clementine. *Proc. Int. Soc. Citriculture* **2**, 175-181 (1988).
7. Gulsen, O., Uzun, A. Pala, H., Canilhos, E., Kafa, G. Development of seedless and Mal seco tolerant mutant lemons through budwood irradiation. *Sci. Hort.* **112**, 184-190 (2007).
8. Starrantino, A., Russo, F., Donini, B., Spina, P. Lemon mutants obtained by gamma irradiation of the nucellus cultured *in vitro*. *Proc. Int. Soc. Citriculture* **2**, 231-235 (1988).

Mutation Breeding of Chrysanthemum by Gamma Field Irradiation and *In Vitro* Culture

S Nagatomi^{1,*} & K Degi²

Abstract

The purpose of this work is to clarify the effect of chronic (gamma field) and acute (gamma room) radiation and *in vitro* culture on mutation induction of flower color in chrysanthemum. The combination of both methods yielded a mutation rate 10 times higher than the conventional chronic cutting method, and also produced non-chimeric mutants. Somaclonal variation often occurred in plants regenerated from callus, but no significant variation appeared in callus regenerants from non-irradiated plants. Therefore, proper mutagenic treatment on cultured materials is indispensable for effective mutation induction. The chronic culture method clearly yielded the widest color spectrum in chrysanthemum, while the acute culture method resulted in a relatively low mutation rate and a limited flower color spectrum. Flower color mutation could be more readily induced in plants regenerated from petals and buds, than from leaves. In this respect, it is supposed that the gene loci fully expressed on floral organs may be unstable for mutation by mutagenesis or culture, but could perhaps induce mutation in a desired direction. A possible reason why the chronic culture methods showed higher frequencies than the acute, is discussed. Nine out of 10 registered mutant varieties were derived from chronic irradiation, and only one from acute. The combined method of chronic irradiation with floral organ cultures proved to be of particularly great practical use in mutation breeding, not only of flower species but of other species as well.

Introduction

Mutation breeding has been successfully applied for variety improvement of many crop species. About 70 % of the world's mutant varieties have been induced through Gamma-rays. There are two streams of Gamma-ray irradiations, chronic and acute. Since the 1960s, 14 chronic irradiation facilities have been constructed worldwide, but all facilities were shut down, except for a gamma field in Japan, which has been operating for almost half a century.

A Japanese pear variety resistant to black spot disease called "Gold Nijisseiki" or "Osa Gold" had been induced and selected in the gamma field, supported by a single and quick selection technique using leaf disks taken from irradiated trees and AK toxin of the disease [1, 2]. An ornamental mutant with pink and yellow striped leaves was induced in a gamma greenhouse and registered as a new variety of pineapple. New mutant varieties of evergreen and dwarfness in Manila grass were selected during the winter in the gamma field [3,4]. This variety can provide green turf throughout the year and reduce lawn-mowing frequencies. A wide spectrum of different shapes and color mutants in roses was induced in the gamma field, and three mutants were registered as new varieties.

The notable results derived from chronic irradiation using gamma field and gamma greenhouse in IRB were reevaluated in cooperation with nine countries in East Asia under the collaborative framework of "Forum for Nuclear Cooperation in Asia" [5]. Recently, new chronic irradiation facilities have been constructed one after another in member countries. A gamma bio-room in Thailand, a gamma greenhouse in Malaysia, and a gamma phytotron in the Republic of Korea are now operating. A gamma field is currently being planned for construction in Vietnam. A new venue for chronic mutation breeding has also opened in East Asia.

The purpose of this study was to clarify the effect of chronic (gamma field) and acute (gamma room) radiations and *in vitro* culture [6] on mutation induction of flower color in chrysanthemum [7, 8], and to establish an effective mutation breeding method for vegetatively propagated plant species.

Materials and Methods

Using a cut flower variety called "Taihei," a number of plants were regenerated from explants of petals, buds, and leaves excised from chronic, acute, and non-irradiated plants. Flower color mutation was then induced through the combined effects and analyzed in comparison with the conventional chronic cutting method.

For chronic irradiation, the gamma field in IRB was used to grow plants on field at optimal dose rates. Gamma-rays were irradiated from a cobalt source (⁶⁰Co 88.8 TBq, 2400 Ci) on the tower in the center of round field (100 m in radius). The growing plants were irradiated at dose rates ranging from 0.25 to 1.5Gy/day for 20 hours every day except Sundays and national holidays. Total treatment doses of plants were from 25 to 150Gy for 100 days until the flowering season of the chrysanthemum.

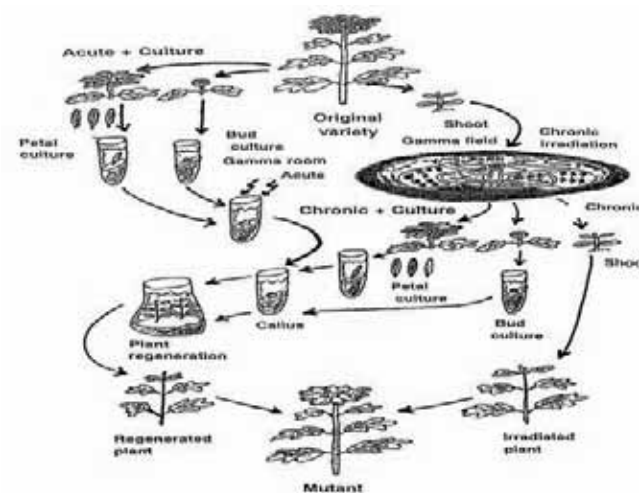

Figure 1 Experimental flowchart

Institute of Radiation Breeding (IRB), National Institute of Agrobiological Sciences (NIAS), Ibaraki, Japan
¹ Bio-oriented Technology Research Advancement Institution (BRAIN), National Agriculture and Food Research Organization (NARO), Tokyo, Japan;
² Okinawa Prefectural Agricultural Research Center, Okinawa, Japan

* Corresponding author. E-mail: nagatomi@affrc.gov.jp

Floral petals, buds, and leaves were excised from the irradiated plants and used as explants for callus induction culture (Fig. 1). In the petal culture, the explant sources were divided into their sectorial patterns.

The callus was induced on a callus medium comprised of Murashige and Skoog's basal formula [9], supplemented with 0.2 mg/l NAA (naphthaleneacetic acid), 1 mg/l BA (benzylamino purine) and 10% *vw* coconut milk. After the calluses were subcultured on the medium, regenerated plants were obtained on a medium composed of MS basal medium supplemented with 0.1 mg/l NAA and 1 mg/l BA. All the cultures were kept under 3000 lux light for 16 hours at a temperature of 27°C. The regenerated plants were acclimatized in a greenhouse, then transplanted to a field nursery to investigate mutation induction. The plants used as the control were established by cutting back twice the lateral shoots of the chronically irradiated plants.

For acute irradiation, the explant sources of leaves, buds and floral petals dissected from unirradiated plants were incubated on callus induction medium after sterilization. After three days of incubation, the explants were irradiated at a dose rate of 10Gy/hr, total doses ranging from 20 to 100Gy in a gamma room (44.4 TBq, ⁶⁰Co source). Soon after irradiation, the segments were transferred to fresh callus induction medium. The induced calluses were subcultured on callus medium and then on the regeneration medium. Regenerated plants derived from each explant source of unirradiated plants were treated for comparison. All of the regenerated plants obtained were transplanted to a field nursery at IRB. The mutant flower colors of the regenerated plants were observed and recorded using a TC-1800 MK-II spectrophotometer.

Results and Discussion

Radiosensitivity of chronic and acute irradiated materials

The radiosensitivity of the growing point of the main stem was estimated to be 100Gy at a 50% survival dose (LD 50) and 150Gy at a lethal dose (LD 100). The number of flowers decreased sharply as irradiation dose rate rose, and few flowers appeared at 1.25Gy.



Figure 2 Flower color mutant lines derived from chronic irradiation using floral petal cultures of chrysanthemum (Upper right: Original "Taihei" variety).

The radiosensitivity of cultured explants to acute irradiation was estimated, and although the callus was induced on explants irradiated at a dose as high as 80Gy, the subsequent regenerability of the callus stayed normal up to 20Gy, but diminished sharply at 40Gy. The critical dose for plant regeneration was assumed to be 40 to 50Gy, and none of the callus retained its generability at 80Gy. Accordingly, the optimum

dose of acute irradiation for cultured explants was estimated to be 20Gy. However, the optimum dose of acute irradiation for cuttings was estimated to be 15-20Gy, and the lethal dose 50Gy. Therefore, the optimum dose of chronic irradiation can be extended to almost 2.5 times that of acute irradiation. The chronic irradiation method employed in the study caused a relatively high accumulation of radiation in regenerants, but reduced adverse radiation damage to the proliferation and differentiation of the callus.

Mutation frequency in flower color

A total of 549 mutants (15%) were obtained from 3,688 plants in the field nursery; 79% of them fell into the category of light to dark pinks similar to the original variety and 21% were a different color from the pinks. A wide spectrum of flower color appeared in individual regenerants derived from floral organ culture. Wide, continuous variations also appeared in the shape and size of the flowers and leaves in regenerants from petal and bud cultures (Fig. 2).

At chronic irradiation, average mutation rates of flower color were 38.7%, 37.5%, 13.8% and 4.7%, respectively, in regenerants from petal, bud, and leaf cultures and shoots (conventional) (Fig. 3). The former two were approximately eight times higher than the latter. At acute irradiation, average mutation rates in regenerants from petal, bud, and leaf explants were 29.7%, 12.0%, and 12.9%, respectively.

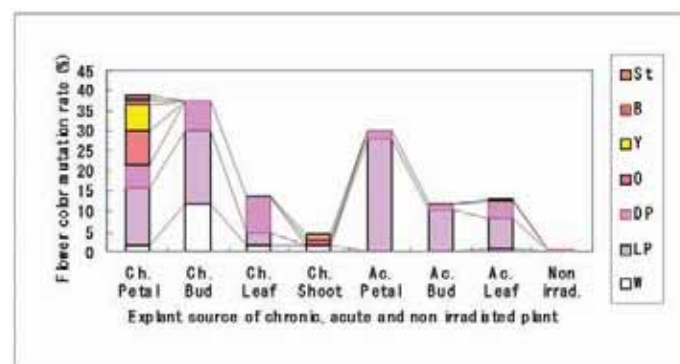

Figure 3 Comparison of flower color mutation rate and color spectra in regenerants derived from cultured explant sources and ordinary shoots from chrysanthemum, induced by chronic, acute and non-irradiation methods. Flower color of regenerants: W=white, LP=light pink, DP=dark pink, O=orange, Y=yellow, B=bronze, and St=striped.

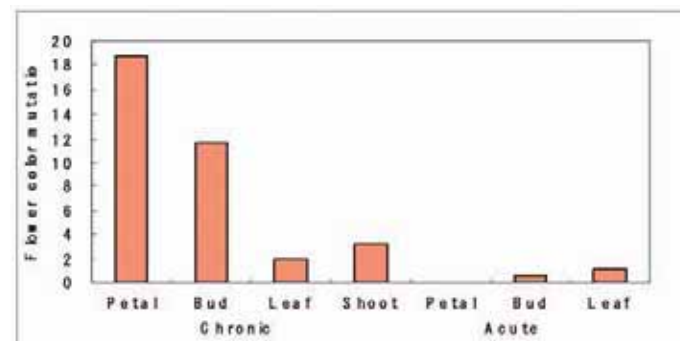

Figure 4 Comparison of flower color mutation rate of all colors, excluding the light and dark pinks that are similar to the original color, in regenerants derived from cultured explant sources and ordinary shoots, induced by chronic and acute irradiation methods.

At non-irradiation, the average mutation rate was a mere 0.5% in regenerants from all types of explants indicating somaclonal variation. Somaclonal variation often occurred in plants regenerated from the callus, but no significant variation appeared in callus regenerants from non-irradiated plants. Therefore, proper mutagenic treatment on cultured materials is indispensable to effective mutation induction.

The method using chronic petal culture gave the highest mutation rate, followed by chronic bud and acute petal cultures. The methods using a leaf with either chronic or acute irradiation provided a lower mutation rate than those using petals and buds. It was noted that most regenerated mutants directly induced from chronic shoots displayed chimera formation.

The mutation rate of all flower colors of the regenerants, excluding the light and dark pinks shown in Fig. 4, indicates which methods extended the mutated color spectrum. Thus, the highest mutation rate was obtained from the chronic petal culture, followed by the chronic bud culture. The other methods that used chronic shoot and chronic leaf culture and all acute irradiation methods proved to have lower mutation rates, with a narrow spectrum.

The chronic culture method clearly yielded the widest color spectrum in chrysanthemum, while the acute culture method resulted in a relatively low mutation rate and a limited flower color spectrum.

Flower color mutation could be more readily induced in plants regenerated from petals and buds, than from leaves. In this respect, it is assumed that the gene loci fully expressed on floral organs may be unstable for mutation by mutagenesis or culture, and therefore results in higher and wider mutations. The choice of desired organ as *in vitro* explants could perhaps induce mutation in a desired direction.

Comparison of mutation induction in chronic and acute irradiations

In short, chronic irradiation using petal and/or bud culture could be an effective method for inducing flower color mutant varieties. A possible reason why the chronic culture methods showed higher frequencies than the acute, is that most of the cells composing the tissue, organs and plant continually irradiated into a cell division and became more sensitive and mutable to irradiation (Fig. 5). It is well known that cells at the G₂ and M stages are more sensitive to radiation than those at the G₁ and S stages.

Under chronic irradiation, if continual low dose Gamma-rays are irradiated onto each cell division every day, mutated cells emerge (Fig. 6). These mutated cells then bear a couple of daughter cells with accumulated mutation in growing organs. Contrarily, under acute irradiation, when the explants composed of various cell stages are irradiated at high doses and dose rates at one time, the dormant cells (G₁, S stages), less sensitive to radiation, were able to survive, but the more sensitive dividing cells (G₂, M stages) were inactivated. In this state, there would be no more accumulation of mutation under acute irradiation. This is the reason why mutants from chronic irradiation yielded a wider color spectrum than those from acute irradiation.

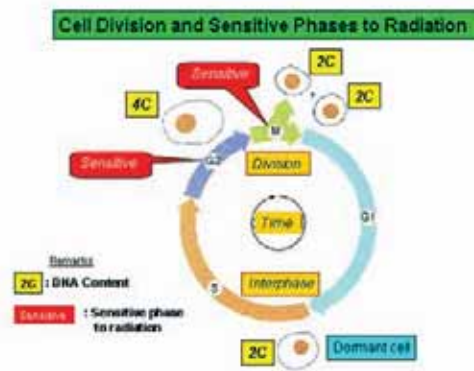

Figure 5 Cell division and phases sensitive to radiation.

In this study, nine out of 10 registered flower color mutant varieties were derived from chronic irradiation. As for culture techniques, five

varieties were derived from chronic petal culture, three from chronic bud culture, one from chronic shoot, and one from acute leaf culture (Fig. 7).

The combined method of chronic irradiation with floral organ cultures proved to be of practical use in mutation breeding, not only of flower species like *Cytisus* and *Eustoma* [10, 11], but also of other species such as sugarcane, pineapple, banana and so on [12, 13, 14].



Figure 6 Relationship between cell cycle and mutation induction under chronic and acute irradiations.



Figure 7 The original variety, "Taihei," its registered mutant varieties and their induced methods using *in vitro* cultures of explants taken from different organs in chrysanthemum under chronic, acute and non irradiations. Chr.: chronic irradiation, Acu.: acute irradiation.

Conclusions

1. The optimum dose of chronic irradiation can be extended to almost 2.5 times that of acute irradiation. The chronic irradiation method employed in this study caused a relatively high accumulation of radiation in regenerants, but reduced adverse radiation damage to the proliferation and differentiation of the callus.
2. The combined methods of irradiation and *in vitro* culture yielded a mutation rate eight times higher than the conventional chronic cutting method, also producing non-chimeric mutants (Fig. 3).
3. Somaclonal variation often occurred in plants regenerated from callus, but no significant variation appeared in callus regenerants from non-irradiated plants. Therefore, proper mutagenic treatment on cultured materials is indispensable for effective mutation induction (Fig. 3).
4. The chronic culture method clearly yielded the widest color spectrum in chrysanthemum, while the acute culture method resulted in a relatively low mutation rate and a limited flower color spectrum (Fig. 4).

5. Flower color mutation could be more readily induced in plants regenerated from petals and buds, than from leaves. In this respect, it is supposed that the gene loci fully expressed on floral organs may be unstable for mutation by mutagenesis or culture, but could perhaps induce mutation in a desired direction (Fig. 4).
 6. A possible reason for why the chronic culture methods showed higher frequencies than the acute, is that most of the cells composing the tissue and organs continually irradiated into a cell division and became more sensitive and mutable to irradiation (Fig. 5). Under these conditions, many small mutated sectors accumulated in the cells of growing organs. In contrast, when explants composed of various cell stages were irradiated at high doses and dose rates, the dormant cells, less sensitive to radiation, were able to survive, but the more sensitive dividing cells were inactivated (Fig. 6).
 7. In this study, nine out of 10 flower color mutant varieties registered were derived from chronic irradiation (Fig. 7). The combined method of chronic irradiation with floral organ cultures proved to be of particularly great practical use in mutation breeding, not only of flower species but of other species as well.
 8. By using this technique, a number of useful mutant varieties could be developed in many kinds of crops, such as sugarcane, pineapple, *Eustoma* and *Cytisus*.
3. Nagatomi, S. *et al.* A new variety of Manila grass, "Winter Field". Frost resistance and dwarf mutant. *Technical News* **63**, 1-2 (1998).
 4. Nagatomi, S., Mitsui, K., Miyahara, K. Selection of evergreen mutant lines in Manila grass (*Zoysia matrella* MERR.). *Technical News* **44**, 1-2 (1993).
 5. Forum For Nuclear Cooperation In Asia (FNCA). <http://www.fnca.mext.go.jp/> <http://www.fnca.mext.go.jp/mb/mbm/mbm.html>
 6. Ahloowalia, B.S. *In vitro* techniques and mutagenesis for the improvement of vegetatively propagated plants. In: Somaclonal Variation and Induced Mutations in Crop Improvement, p.293-309 (1998).
 7. Broetjes, C., Roest, S., Bockelmann, G.S. Mutation breeding of *Chrysanthemum morifolium* Ram. Using *in vivo* and *in vitro* adventitious bud techniques. *Euphytica* **25**, 11-19 (1976).
 8. De Jong, J., Custer, J.B.M. Induced changes in growth and flowering of chrysanthemum after irradiation and *in vitro* culture of pedicels and petal epidermis. *Euphytica* **3(5)**, 137-148 (1986).
 9. Murashige, T., Skoog, F.A. Revised medium for rapid growth and bioassays with tobacco tissue cultures. *Physiol Plant* **15**, 473-497 (1962).
 10. Nagatomi, S., Katsumata, K., Nojiri, C. Induction of dwarf-type plants derived from *in vitro* cultures by gamma-rays irradiation in *Cytisus* Genus. *Technical News* **51**, 1-2 (1993b).
 11. Nagatomi, S. *et al.* Three mutant varieties in *Eustoma grandiflorum* induced through *in vitro* culture of chronic irradiated plants. *Technical News* **53**, 1-2 (1996).
 12. Nagatomi, S. Enlargement of induced variations by combined method of chronic irradiations with callus culture in sugarcane. *Gamma Field Symposia* **30**, 87-110 (1991).
 13. Nagatomi, S. Effects of various irradiation methods on mutation induction of regenerants through leaf trimming and tissue culture in pineapple. *Technical News* **41**, 1-2 (1992).
 14. Nagatomi, S. *et al.* Combined effect of gamma irradiation methods and *in vitro* explant sources on mutation induction of flower color in *Chrysanthemum molifolium* RAMAT. *Gamma Field Symposia* **35**, 51-68 (1996).

BIBLIOGRAPHY

1. Sanada, Tetsuro Induced mutation breeding in fruit trees: Resistant mutant to black spot disease of Japanese pear. *Gamma Field Symposia* **25**, 91-102 (1994).
2. Masuda, T., Yoshioka, T., Ito, Y. New Japanese pear cultivar 'Osa Gold'. A mutant resistant to the black spot disease from a self-compatible Japanese pear. *Technical News* **61**, 1-2 (1998).

Enhancing Genetic Diversity Through Induced Mutagenesis in Vegetatively Propagated Plants

C Mba*, R Afza, J Jankowicz-Cieslak, S Bado, M Matijevic, O Huynh & B J Till

Abstract

Conventionally, crop improvement strategies rely not only on the availability of heritable genetic variations within utilizable genetic backgrounds, but also on the transferability of the traits they control through hybridizations between the parental stocks. Procedures for producing hybrids of sexually reproducing plants are routine, while for vegetatively propagated plants, hybridizations are usually impractical. Therefore, the improvement of crops that lack botanical seeds necessitates alternative strategies for generating and utilizing genetic variations. Induced mutagenesis generates allelic variants of genes that modulate the expression of traits. Some of the major drawbacks to the widespread use of induced mutations for vegetatively propagated plants include the difficulties of heterozygosity of the genetic backgrounds, the incidence of chimeras and the confounding effects of linkage drags in putative mutants. In general, the inherent inefficiencies of time and space economies associated with induced mutagenesis are further exacerbated in vegetatively propagated crops mostly on account of the need for continual propagation. We highlight the mitigating roles on these drawbacks of judicious integration of validated biotechnologies and other high throughput forward genetics assays in induced mutagenesis pipelines. Using cassava and banana as models, we demonstrate the use of cell and tissue biology to achieve homozygosity, minimize or eliminate chimeras, and significantly shorten the duration of the generation of mutants. Additionally, use of these biotechnologies to attain significantly reduced propagation footprints while evaluating putative mutants without compromising population size is also presented. We also posit that molecular biology approaches, especially reverse genetics and transcriptome assays, contribute significantly to enhancing the efficiency levels of the induced mutagenesis processes. The implications for crop improvement and functional genomics via the concerted application of biotechnologies in the generation, identification, and tagging of mutation events in the genomes of vegetatively propagated crops are also discussed.

Introduction

Mutation, the heritable change to the genetic make-up of an individual, is a naturally occurring phenomenon. The outcome of the interplay of the accumulation of mutation events and the modulating influences of natural and artificial selection pressures is manifested in the evolutionary process. A vivid contribution of mutation to agriculture is crop speciation and domestication. Characterized mutation events that discriminate cultivated plant species from their wild relatives include the abolishment of shattering in cultivated peas and cereals such as barley and wheat. Other examples include non-bitter edible almonds and parthenocarpy that confers seedlessness in grapes and other fruits, e.g. bananas. A recent exploitation of a mutation event that is amply

chronicled in literature is the isolation of the semi-dwarf characteristics in wheat by scientists at the International Center for Maize and Wheat (CIMMYT, its Spanish acronym) in Mexico. The massive generation and deployment of wheat varieties with the mutant *sd1* gene, characterized to be a mutation leading to a deficiency in the growth hormone, gibberellic acid, led to the Green Revolution [1].

Early in the 20th century, X-rays and other forms of radiation were discovered; the demonstration of the ability of these physical agents to cause mutations followed quickly afterwards [2, 3, 4]. Naturally occurring mutations are referred to as spontaneous mutations, as opposed to induced mutations that are brought about through artificial means. For the past 80 years, mutation induction has been a routine tool for the generation of genetic variation in crop germplasm, and has been overwhelmingly used in crop improvement, a strategy that is known as Mutation Breeding. The use of these mutant stocks has since been expanded to include the more upstream activities of functional genomics which encompasses a body of procedures relating to the discovery of genes and elucidation of their functions. This has been achieved through the production of insertional and gene knockout lines. More recently, plants harboring induced subtle genome alterations, usually single base pair changes, are becoming commonly used in gene discovery and functional studies through the association of changes in their DNA sequences to modified phenotypic expressions.

Vegetatively propagated crops

A wide range of crops, grown for their edible roots, tubers, fruits, aerial stems and leaves, are not planted using botanical seeds. When plant parts other than true sexual seeds are used for propagating a plant, the mode of propagation is referred to as vegetative. Vegetatively propagated crops play critical food security roles in the tropical and neo-tropical regions of Africa, Asia and Latin America and the Caribbean. Increased and stable yields in these crops are therefore imperative for meeting the dietary needs of the rapidly growing populations in these parts of the world. Conventional crop improvement, predicated upon the availability of utilizable desirable genetic variation, is dependent upon the breeders' ability to generate progeny from hybridizing parental stocks. This is not an option for plants which, for a variety of reasons, are vegetatively propagated crops.

Due to this handicap, the development of improved varieties with stable high yields that enhance the nutritional status of the populace, are tolerant of the myriad of biotic and abiotic stresses, and suffer minimal post-harvest losses, remain veritable challenges to breeders for many of the staple food security crops in the tropics and neo-tropics. This daunting task is exacerbated by the other biological constraints of high heterozygosity of vegetatively propagated crops, the high levels of systemic disease and pest inoculums.

Survey of induced crop mutants

Considering the aforementioned drawbacks to the use of conventional hybridization-based strategies for the genetic improvement of veg-

Plant Breeding Unit, FAO/IAEA Agriculture & Biotechnology Laboratory, IAEA Laboratories Seibersdorf, International Atomic Energy Agency, Wagramer Strasse 5, P.O. Box 100, A 1400 Vienna, Austria

* Corresponding author. E-mail: c.mba@iaea.org

etatively propagated crops, it would be reasonable to assume that plant breeders and other scientists engaged with the generation of new varieties of these crops have been making use of induced mutations and other novel genetic improvement interventions. The facts however belie this assumption.

The elegant surveys of officially released induced crop mutants in [5] and [6] indicate that seed propagated crops constitute the overwhelming majority of crop mutant varieties. Of the 1,700 officially released crop mutant varieties surveyed in [5], only 97 were vegetatively propagated crops (Fig. 1). A similar skewed trend in favor of a disproportionately large ratio of seed propagated mutant crop varieties is evident when all mutant plant varieties (and not only crops) are surveyed. A search of the Joint FAO/IAEA Mutant Varieties Database [7] in November of 2008 showed that out of the total entry of 2,797 mutant plant varieties, only 310 vegetatively propagated mutant plant varieties (including food crops, ornamental plants and animal feeds crops) were listed (Fig. 1).

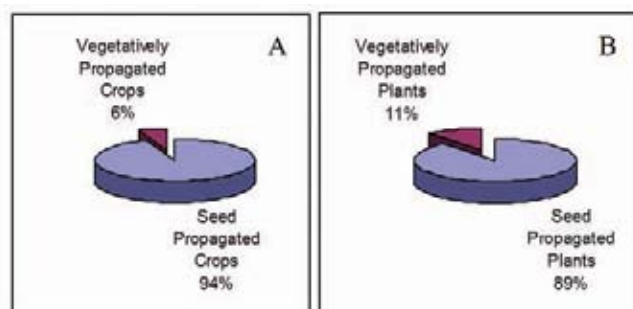

Figure 1 Officially released mutant crop varieties by mode of propagation: A, in 2000 [5]; B, in November 2008 [7].

Ahloowalia, *et al.* [6] highlighted this relative paucity of vegetatively propagated mutant crop varieties. Interestingly, according to these authors, the few vegetatively propagated mutant crop varieties were enthusiastically adopted by farmers and have been contributing to enhanced income for the growers. The most striking examples of these mutants, excluding the ornamental plants, are shown in Table 1.

Table 1. Summary of some widely cultivated vegetatively propagated mutant crop varieties with significant economic values for growers. Adapted from [5] and [6]

Crop type	Plant	No. of mutants
Oil	Peppermint	2
Fruit	Orange (Mandarins)	5
	Apple	10
	Banana	2
	Apricot	1
	Sweet Cherry	8
	Sour Cherry	4
	Peach	2
	Pomegranate	2
	Pear	5
	Japanese Pear	2
	Black Currant	1
	Ribes	1
	Raspberry	1
	Grape	1
Root	Cassava	1

Of note are the two varieties of peppermint, ‘Todd’s Mitcham’ and ‘Murray Mitcham,’ whose tolerance to *Verticillium* have made them varieties of choice in the US. Others are the 48 mutant varieties of fruits including the ‘Gold Nijisseiki’ Japanese pear (*Pyrus pyrifolia*), which is resistant to black spot disease (caused by *Alternaria alternata*), and the ‘Rio Star’ grapefruit which accounts for 75% of the grapefruit production area in Texas, USA. The inference from the widespread adoption and cultivation of these vegetatively propagated mutant crop varieties is that the relatively depressed number of mutant varieties in this class of crops is not for want of end-users. The reasons derive from the peculiarities inherent in the reproductive biology of these crops; overviews of these bottlenecks will be reviewed in subsequent sections of this paper.

Drawbacks to the induction of mutation in vegetatively propagated crops

In general, a major drawback to the routine application of induced mutagenesis to both crop improvement and genomics studies (through forward and reverse genetics strategies, respectively) remains the drudgery of producing, handling and assaying the requisite large populations of mutant stocks. This is because since the success of induced mutations is a function of statistical probability, protocols are not yet available (nor readily feasible) for targeted gene modifications, and large population sizes must be created in order to have a fair chance of detecting desirable mutations. This is expensive, laborious and time-consuming. For obligate vegetatively propagated plants, the starting materials for inducing mutations cannot be botanical seeds, usually more convenient to handle than the bulkier vegetative propagules, as is the case with the seed propagated crops. This immediately poses the first problem of footprint as at the very least, more space is required for handling the propagules and more time and resources will have to be invested in the actual exposure of the propagules to the mutagenic agent. This drudgery continues into the evaluation of the putative mutants, as this typically also requires more time and resources. Other peculiarities of vegetatively propagated plants go beyond this drudgery and require deliberative strategizing in order to efficiently generate mutants. The most common issues include the absence of meiotic sieves; the concurrent fixation of deleterious alleles; the transmission of pathogens to subsequent generations, and most importantly, the preponderance of chimeras [8].

Absence of meiotic sieves

Point mutations, physiological damage (primary injury), and chromosomal aberrations have often been identified as the three main effects of mutagenesis. In seed propagated crops, gross chromosomal aberrations – which are lethal – are ‘sieved’ out at the first mutagenic generation (M_1), as well as the physiological damages that are extra-nuclear. In practice, only point mutations and other non-lethal mutations are carried over to the next generations in seed propagated crops. With meiosis not intervening in the advancement of putative mutants to subsequent generations, this ‘sieve’ mechanism is obviated leading to the accumulation of inordinate levels of unintended mutation events.

Concurrent fixation of deleterious alleles

Pleiotropic effects, occasioned by creation of new alleles through mutagenesis, or linkage drags (the co-segregation of desirable with deleterious alleles), are easily mitigated through hybridization, usually backcrossing to the desirable genetic background. In vegetatively propagated crops, this facility cannot be exploited, leading to the accumulation of undesirable genic effects in the induced mutant. An otherwise excellent induced mutant could be dispensed with on this account, a situation that may have some contributory roles in the relatively lower numbers of induced mutants in this class of crops.

Transmission of pathogens to next generations

Plant pathogens - fungal, bacterial and viral – through systemic infection are propagated along with the host from one generation to the next. The presence of disease agents in a putative mutant may confound detection of the phenotypic expression of the mutation event. While systemic infection could also result in transmission of pathogens through seeds, the sheer bigger size of vegetative propagules ensures greater loads of inoculums of disease-causing agents which accumulate over generations.

Chimeras

A result of using a multi-cellular tissue (as most vegetative plant propagules do) as the starting material for mutation induction is the incidence of chimeras, i.e. sectorial differences whereby different mutation events exist side-by-side in the same individual. Bearing in mind the characteristic totipotency of plant cells, the ontogeny of the progeny from the same putative mutant would be distinctly dissimilar, a situation that is clearly undesirable in generating a mutant population; such a population should be uniform for the mutation event. The handling of the mutagenic population therefore requires significant effort being invested in the dissociation of chimeras, an added drudgery.

Strategies for mitigating the drawbacks to inducing mutations in vegetatively propagated crops

The identified bottlenecks to routine induction, isolation and deployment of mutations in vegetatively propagated crops can be ameliorated through a strategic use of biotechnologies; cell and tissue biology techniques are useful for the efficient production of mutants while molecular biology techniques enhance efficiency in the rapid genotyping of the mutation events, as reviewed below.

Cellular and tissue biology strategies

A critical bottleneck in the routine application of induced mutations in plants is the low level of efficiency of the processes; quality and quantity of induced mutant populations are sub-optimal when conventional strategies are used. Also, mechanisms for discovery and deployment of the mutated segments of genomes could be significantly improved. The requirement for generating and evaluating large population sizes remains imperative being the only way to ensure a fair chance of recovering the desired mutation events. Another drawback, the inherent problem of chimeras, is exacerbated in vegetatively propagated plants. A further significant hurdle is the need to have the mutated segment in a homozygous state so that the mutation, usually recessive, could manifest as a phenotype. A number of *in vitro* techniques have been shown to circumvent or significantly mitigate these bottlenecks to induced mutations. These include cell suspension cultures including somatic embryogenesis, and rapid *in vitro* multiplication. Strategies for mitigating the drawbacks of inducing mutations in a heterozygous state include the recovery of dominant alleles and exploiting existent haplo-insufficiency and limited sexual reproduction.

Somatic embryogenesis

The presence of chimeras, especially in vegetatively propagated crops, confounds strategies employed in the development of homohistonts. The validated methodology for mitigating this problem is to pass the putative mutant through several cycles of vegetative regeneration (*in vitro* and *in vivo*). The added expense, in terms of time and resources, could be circumvented through the use of single cells as starting materials for inducing mutations and subsequently regenerating whole plantlets from them, a path that mimics classical embryos (involving zygotes) and is referred to as somatic embryogenesis. This process typically involves mass proliferation of undifferentiated cells – callus – and subsequently through the modification of culture media, the induction of embryogenic properties in the cells. Typically, the most common paths taken include

the production of cell suspension cultures and friable embryogenic calli (FEC). The individual cell is then exposed to the mutagen, and taking advantage of the potential of each plant cell to regenerate into a whole plant, a phenomenon known as totipotency, plantlets are regenerated on appropriate culture media. Cell suspension culture processes include the production of cell lines from callus followed by the regeneration of plantlets through somatic embryogenesis. The FEC path circumvents the culturing of cells on liquid media, rather through the manipulation of growth media, embryogenic structures are induced which subsequently regenerate whole plantlets. Since Nickell [9] demonstrated the cell suspension technique with *Phaseolus vulgaris*, reproducible protocols have been validated for other plant species. This ability to grow individual plant cells under aseptic conditions, and from them, regenerate whole plantlets, permits the exposure of individual cells to mutagens. Arising from an individual cell, each plantlet is devoid of chimeras. Obviating therefore the requirement for several cycles of regeneration, significant gains in time and resources are achieved through this path. Following the demonstration of somatic embryogenesis through cell suspension cultures in *Musa* [10], the use of cell suspension cultures as starting materials in induced mutations has been successfully used in the generation of banana mutants [11, 12]. Lee, *et al.* [13] had also generated homohistonts in cassava through gamma irradiation of FEC in cassava.

Rapid *in vitro* multiplication

Protocols for somatic embryogenesis, being genotype-dependent, are not available for all crop species, therefore limiting the utility of this technology in the efficient induction of mutations in plants. In instances where somatic embryogenesis is an impractical option, or where protocols have not been validated, *in vitro* techniques, especially rapid multiplication systems using meristematic regions of plants, could be used to achieve some level of efficiency in induced mutations. Plantlets are regenerated, but not at the same levels of homozygosity and incidence of chimeras as in somatic embryos. Such plantlets are then passed through several cycles of regeneration to dissociate chimeras. Through this method (irradiation and *in vitro* culture of shoot tips), an induced mutant banana variety, Novaria, currently under cultivation in Malaysia, was developed [14]. Roux, *et al.* [11] reported that incidence of cytochimeras in *Musa* was reduced to 8% after three subcultures of plantlets arising from multi-apices. This could be used as a guide as it has not been possible to empirically demonstrate the complete elimination of chimerism through sub-culturing of the plantlets. Owoseni, *et al.* [15] reported the use of *in vitro* nodal segments as starting materials for the induction of mutations in cassava.

Molecular biology techniques for enhancing efficiency in induced mutations

While cell biology techniques could be used to address the bottlenecks imposed by the need to rapidly generate large mutant populations of suitable genetic backgrounds (homozygous for the mutation events, and devoid of chimeras), there is still a compelling need to query the mutant populations for the mutation events. This is of course not peculiar to vegetatively propagated crops, but nevertheless deserves a mention. Direct field trials or laboratory assays for the traits of interest for the large mutant population is usually laborious, expensive and hardly cost-efficient. Molecular biology strategies offer mechanisms for direct querying of target genes for changes. Molecular biology might not provide conclusive evidence of the desired mutation in itself, but such techniques will significantly obviate the need for field trials of large populations, enhancing the efficiency of the processes.

Reverse genetics strategies, especially Targeting Induced Local Lesions IN Genomes (TILLING), through its inherent high throughput platform, promise to be indispensable tools for the efficient and rapid identification of mutation events. Making use of a combination of polymerase chain reaction amplification of target regions of the genome and a subse-

quent identification of mutations in the target region through enzymatic mismatch cleavages [16, 17, 18], TILLING has been demonstrated in the identification of induced mutations in wheat [19].

Conclusions and perspectives

Continually, the scientific community is recognizing the critical roles of induced mutations in crop improvement and functional genomics. Thus, 'designer crop varieties,' such as high-yielding crops with targeted modifications to their genomes, are needed to address the uncertainties of global climate change and variations, and the expected increase in global food insecurity. There is a compelling need to invest significant efforts in the development of strategies for an efficient use of induced crop mutants in producing crops that are adapted to harsh environments and the development of genomics tools for use in marker-aided selection. On account of the almost total absence of sexual reproduction, genetic improvement of vegetatively propagated crops presents particular problems for which induced mutagenesis might be the most viable cost-effective solution. However, sub-optimal breeding strategies for these crops also affect the efficiency levels in the use of induced mutagenesis. One of the most serious identified bottlenecks is the incidence of chimeras, a problem that could be mitigated by a strategic deployment of appropriate cell and tissue biology techniques.

The need for recessive mutations to be in a homozygous state in order to manifest phenotypically, also poses a significant hurdle. However, the fact that vegetatively propagated plants that were induced to mutate using vegetative propagules constitute 11% of all reported officially released mutant plant varieties [7], demonstrates the feasibility of mutation breeding. The causative mutations underlying the mutant varieties are unknown. Phenotypic manifestations in the varieties could be ascribed to the abolishment of function in loci with only one active gene copy. The frequency of heteroalleles will be increased in vegetatively propagated species because of spontaneous accumulation of deleterious mutations and the lack of meiosis, independent assortment, and selection to cull such mutations from the population. Heterozygous mutations will also reveal haploinsufficient loci. It is also probable that dominant mutations could be in play for some of the traits in these vegetatively propagated crops.

As with seed propagated crops, the rapid and cost-effective identification of mutation events is desirable and could be achieved by using molecular biology tools to query targeted regions of the genome for mutations. Reverse genetics methodologies, especially those amenable to high throughput – in order to efficiently evaluate the requisite large mutant population sizes – such as TILLING, hold great promise for the use of molecular biology techniques to rapidly whittle down the size of putative mutants before field trials or other assays with cost implications that are required to confirm the phenotypic expression of the desired mutation. The reasoning is that if TILLING for instance, does not uncover a mutation in the target gene (already implicated in the expression of a trait), it is unlikely that the putative mutant would express a phenotypic variation from the wild-type, negating therefore the need for any further evaluation of that candidate. This could be a major contribution to easing the drudgery associated with induced mutations in crops, especially for crop breeding.

Validated protocols exist for these different biotechnologies, but a need remains for the assemblage, adaptation and interlacing of these novel cell and molecular biology techniques into components of the induced mutations process, as well as the adaptation to specific crops. The generation of protocols along these themes, in manners that achieve a seamless dovetailing of validated processes into a modular pipeline, will significantly ameliorate above drawbacks and consequently aid the routine application of induced crop mutations in crop improvement and in gene discovery and elucidation.

BIBLIOGRAPHY

1. Spielmeier, W., Ellis, M.H., Chandler, P.M. Semidwarf (*sd-1*), "green revolution" rice, contains a defective gibberellin 20-oxidase gene. *PNAS* **99**(13), 9043–9048 (2002).
2. Muller, H.J. Artificial transmutation of the gene. *Science* **66**, 84-87 (1927).
3. Muller, H.J. The production of mutations by X-rays. *PNAS* **14**, 714-726 (1928).
4. Stadler, L.J. Genetic Effects of X-rays in Maize. *PNAS* **14**, 69-75 (1928).
5. Maluszynski, M., Nichterlein, K., Van Zanten, L., Ahloowalia, B.S. Officially released mutant varieties – the FAO/IAEA database Mutation Breeding Reviews. The Joint FAO/IAEA Programme of Nuclear Techniques in Food and Agriculture, International Atomic Energy Agency, Vienna, Austria. p.88 (2000).
6. Ahloowalia, B.S., Maluszynski, M., Nichterlein, K. Global impact of mutation-derived varieties. *Euphytica* **135**, 187-204 (2004).
7. <http://mvgs.iaea.org/Search.aspx>
8. Van Harten, A.M. Mutation Breeding. Theory and practical Applications. Cambridge, U.K.: New York, Cambridge University Press. p.353 (1998).
9. Nickell, L.G. The continuous submerged cultivation of plant tissue as single cells. *Proc. Nat. Acad. Sci. U.S.A.* **42**, 848-850 (1956).
10. Novak, F.J., Afza, R., Van Duren, M., Perea Dallos M., Conger B.V., Tang X. Somatic embryogenesis and plant regeneration in suspension cultures of dessert (AA and AAA) and cooking (ABB) bananas (*Musa* spp.). *Bio/Technology* **7**, 154-159 (1989).
11. Roux, N., Tolosa, A., Dolezel, J., Panis, B. Usefulness of embryogenic cell suspension cultures for the induction and selection of mutants in *Musa* spp. In: Jain SM and Swennen R (Eds). Banana Improvement: Cellular, Molecular Biology and Induced Mutations. Science Publishers, NH, USA. p.33-43 (2004).
12. Lopez, J., Strosse, J.H., Ventura, J. De La C., Sanchez, R., Rodriguez, S., Swennen, R., Panis, B., Afza, R. Field evaluation of potential mutants obtained after gamma irradiation of banana and plantain (*Musa* spp.) shoot-tip and embryogenic cell cultures. In: Jain SM and Swennen R (Eds). Banana Improvement: Cellular, Molecular Biology and Induced Mutations. Science Publishers, NH, USA. p.87-96 (2004).
13. Lee, K.S., Van Duran, M., Morpurgo, R. Somatic embryogenesis in cassava: a tool for mutation breeding. Proceedings of a final RCM of a FAO/IAEA CRP, held in Naples, Italy, 30 October – 3 November, 1997. IAEA-TECDOC-951. International Atomic Energy Agency, Vienna, Austria. p.55–60 (1997).
14. Novak F.J., Afza R., Van Duren M., Omar M.S. Mutation induction by gamma irradiation of *in vitro* cultured shoot tips of banana and plantain (*Musa* spp.). *Tropical Agric. Trinidad* **67**, 21-28 (1990).
15. Owoseni, O., Okwaro, H., Afza, R., Bado, S., Dixon, A., Mba, C. Radiosensitivity and *in vitro* mutagenesis in African accessions of cassava, *Manihot esculenta* Crantz. International Atomic Energy Agency, Vienna, Austria. *Plant Mutation Reports* **1**(2), 32-36 (2007).
16. McCallum, C.M., Comai, L., Greene, E.A., Henikoff, S. Targeted screening for induced mutations. *Nat Biotechnol.* **18**, 455–457 (2000a).
17. McCallum, C.M., Comai, L., Greene, E.A., Henikoff, S. Targeting induced local lesions IN genomes (TILLING) for plant functional genomics. *Plant Physiol.* **123**, 439-442 (2000b).
18. Till, B.J., Reynolds, S.H., Greene, E.A., Codomo, C.A., Enns, L.C., Johnson, J.E., Burtner, C., Odden, A.R., Young, K., Taylor, N.E., Henikoff, J.G., Comai, L., Henikoff, S. Large-scale discovery of induced point mutations with high-throughput TILLING. *Genome Res.* **13**, 524-530 (2003).
19. Slade, A.J., Fuerstenberg, S.I., Loeffler, D., Steine, M.N., Facciotti, D. A reverse genetic, nontransgenic approach to wheat crop improvement by TILLING. *Nat Biotechnol.* **23**, 75-81 (2005).

Induction and Identification of Useful Mutations for Root Quality Traits in Cassava

T Sanchez¹, A Roserob, A P Tofiño², K Denyer³, A Smith³, H Ceballos^{1,2,*}, D Dufour⁴, N Morante¹ & J C Pérez¹

Abstract

A population of about 1,500 M_2 genotypes (from five different cassava families), were screened for relevant traits. Roots could be harvested from 800 of these genotypes and thoroughly screened for starch quality traits. Four distinctive phenotypes were identified: a small granule, high-amylose starch mutation with almost no paste viscosity, a group of genotypes with tolerance to post-harvest physiological deterioration, a “hollow” starch granule mutation with intermediate viscosity peaks, and a group of genotypes with a starchless (potentially “sugary”) root mutation. The last two mutations need to be further characterized and confirmed. The small granule mutation has been fully characterized and a lesion in the isoamylase one or two loci has been postulated to be the most likely site. The frequency of this mutation (present in two lineages out of the 800 M_2 genotypes analyzed) suggests that mutation at the putative locus is easy to attain, or else that the repair mechanisms are less efficient at that site. Several of these unusual phenotypes identified offer important commercial advantages.

Introduction

Cassava (*Manihot esculenta* Crantz), is a perennial crop originated and domesticated in the neo-tropics [1, 2]. Its most common product is the starchy root, but the foliage has an excellent nutritional quality for animal and human consumption [3]. Cassava is the fourth most important basic food and is a fundamental component in the diet of millions of people [4, 5]. The crop produces well under marginal conditions, particularly due to its tolerance to drought and infertile soils and its ability to recover from disease and pest attacks. It can also produce well in non-marginal areas. Cassava offers the advantage of a flexible harvesting date, allowing farmers to hold the roots in the ground until needed [6, 7].

In addition to its role in subsistence farming and food security, cassava is increasingly used as raw material for many industrial applications: as a source of energy in animal diets, for the starch industry and, more recently, in bio-ethanol production [7]. The presence of cyanogenic glucosides in the root limits their use [8]. Another constraint is the short shelf life of roots due to post-harvest physiological deterioration (PPD). PPD begins within 24 hours after harvest [9, 10], and rapidly renders the roots unpalatable and unmarketable. Consequently, cassava roots need to be consumed or processed soon after harvesting [11]. Finally, cassava has the disadvantage of low genetic variability for root starch traits [12, 13, 14]. The fact that roots are not reproductive or multiplicative organs may offer cassava (and other root crops) an advantage over seed-propagated crops.

In spite of their low frequency, generally negative effects and unpredictability of results, the induction of mutations has been a successful

approach to generate new variability in other crops where natural genetic variation is limited and insufficient. As a result, several varieties have been developed after induction of mutations [15, 16]. CIAT and National University of Colombia have implemented a joint mutation-breeding project in search of genetic modifications for useful traits. As a result of this project, cassava genotypes that showed distinctive root quality characteristics were identified in March 2006, and further confirmed in harvests in March of 2007 and March of 2008.

Materials and Methods

As part of the project to identify cassava germplasm with novel root or starch quality characteristics, CIAT and Universidad Nacional de Colombia (Palmira Campus) initiated a project to induce mutations in botanical seed from five different families. The project benefited from the financial and technical support of the International Atomic Energy Agency and the Rockefeller Foundation.

Seed Irradiation to obtain the M_1 generation, field growth and production of the M_2 generation

About 1400 botanical seeds from five different full or half-sib families (Table 1) were irradiated with 200Gy Gamma-rays (from Cobalt⁶⁰). The irradiated seed (M_1 generation) was germinated and grown in the greenhouse for two months. Seedlings were then transplanted to the field and normal cultural practices were used to maintain the crop in good growing conditions. By August 2004 several M_1 plants started to flower. Flowering in cassava does not follow a pre-defined pattern. Some genotypes flower few months after planting (four to five months), some do later in the season (six to nine-month-old plants) and some just fail to flower. Whenever possible, the M_1 plants were self-pollinated to generate M_2 seed. This action was fundamental to eliminate chimeras which are very common in M_1 generation. It is also important to increase the level of inbreeding, thus facilitating the phenotypic identification of recessive traits (a typical feature of mutations). As is frequently the case, irradiation affected vigor negatively.

Screening for useful traits in the M_2 generation

M_2 seeds were germinated and transplanted to the field in May 2005. About 1,500 M_2 genotypes were derived from the self-pollinations made during the previous season. In most cases, several M_2 genotypes were obtained from the same M_1 plant. M_2 plants were weak because, in addition to the mutations they were carrying that affected their general performance, they also suffered from the natural inbreeding depression. Nonetheless, up to 800 of these M_2 plants were vigorous enough to produce roots from which starch could be extracted. Harvest took place in March 2006. Only one plant per genotype was available because evaluations were made on individual plants obtained from botanical seed. At least one commercial-size root was harvested per genotype. Whenever possible, up to five roots per plant and genotype were harvested. Two tests were made immediately after harvest: iodine staining and analysis of starch granule morphology with an optic microscope. Roots were

¹ Cassava Breeding Project, International Center for Tropical Agriculture (CIAT), Cali, Colombia

² National University of Colombia, Palmira Campus, Palmira, Colombia

³ John Innes Center, Norwich Research Park, Norfolk, UK

⁴ CIRAD-PERSYST, Montpellier, France

* Corresponding author. E-mail: h.ceballos@cgiar.org

then washed and peeled before samples were prepared for the different analyses performed.

Iodine-stained field evaluation of roots

As soon as roots were harvested they were cut and one of the transversal sections was sprayed with iodine solution 2% (2g KI and 0.2g I₂ in 100cm³ of distilled water). Reddish-brown staining is typical of amylose-free starch, whereas cassava starch with normal amylose-amylopectin mixture stains dark-blue.

Optic and scanning electron microscopy (SEM)

A microscope slide was rubbed against the freshly cut section of the roots and stained with iodine solution 0.2%. The slide was observed through a light microscope (Olympus CX41) using a 40X magnification lens. If the initial optic analysis suggested changes in starch granule morphology, more detailed analysis was conducted with a scanning electron microscope. Dehydrated starch granules were sprinkled on double sided sticky tape, mounted on circular aluminium stubs, coated with 35 nm of gold-aluminium, and then photographed in a Scanning Electron Microscope (JSM 820 Jeol, Tokyo, Japan) at an accelerating voltage of 20 kV.

Granule size and distribution

Starch granule size and distribution was determined with a laser diffraction particle size analyzer (SALD-3001-Shimadzu Japan). This kind of study was only done on samples whose preliminary results suggested changes in starch granule morphology and/or size. Starch samples were mixed with distilled water and one drop of sodium hexametaphosphate (0.2%) was added. Suspension was mixed using a mechanical stirrer and sonicated to obtain a laser light obscuration level of ~ 30%. Refractive index of 1.600±0.101 was set for the starch. Measurements were run in triplicate on two different starch samples per genotype at room temperature.

Other tests

Other tests, following the standard procedures of the root quality laboratory at CIAT [17] were conducted in roots, flour or starch from the "seedling plants" (plants derived from botanical seed, not vegetative cuttings): cyanogenic potential, root and starch moisture content, paste clarity, colorimetric amylose determination, pasting properties, swelling power, solubility and dispersed volume fraction measurements. Any genotype whose analyses suggested a change in root quality trait(s) or modifications in plant architecture or physiology, was immediately selected and stem-cuttings were obtained to vegetatively multiply it. Cloned genotypes were then harvested in March 2007 and March 2008 to confirm the stability of the changes and their genetic nature and to provide further phenotypic information.

Results

A total of 11 M₂ genotypes derived from botanical seed irradiated with Gamma-rays were selected because of their unusual characteristics. As explained above the M₂ genotypes, initially selected in "seedling plants," were cloned as soon as their unusual characteristics were first identified.

Small-granule, high-amylose starch mutation

Results from the discovery of a small-granule mutation (SGM) have already been published [18]. A total of four genotypes with a similar starch phenotype were identified. Three of these genotypes (5G160-13; 5G160-16; 5G160-18) originated from self-pollinations the same M₁ genotype (5G160), which traces back to family C4 from the TME3 x TMS30555 cross (Table 1). They were therefore, siblings from the same mother plant and their special starch phenotype originated in a common mutation event induced in the M₀ seed. The fact that these three related

genotypes expressed the same unusual starch phenotype was a strong indication that their special starch characteristic was, indeed, genetically controlled. The fourth genotype (3G43-1) was the only M₂ plant derived from the M₁ genotype (3G43) expressing the same starch phenotype observed in the 5G160 M₂ family. 3G43 originated in SM 3015 (Table 1), which is an open-pollinated family whose female progenitor was MCOL 1505 and different known potential male progenitors acted as source of pollen.

Table 1. Cassava germplasm irradiated with Gamma-rays (from Cobalt⁶⁰)

Family	Mother	Father	No. Seeds	
1	CM 9331	SM 1210-10	MNGA 1	150
2	SM 3015	MCOL 1505	Unknown	150
3	SM 3045	HMC 1	Unknown	150
4	GM 155	MTA1 1	SM 2102-34	153
5	C-4	TME3	TMS30555	787

The initial evidence of unusual starch granule morphology was first observed through light microscope analysis of the starch from the four genotypes, which were distinctively smaller than wild-type (WT) (Fig. 1). Further evaluation through scanning with an electron microscope not only confirmed the smaller size of starch granules, but a surface that was not as smooth as in WT starch granules (Fig. 1). Results from the laser diffraction particle size analyzer indicated that granule size was about one third the typical average of WT cassava starch granules (Table 2).

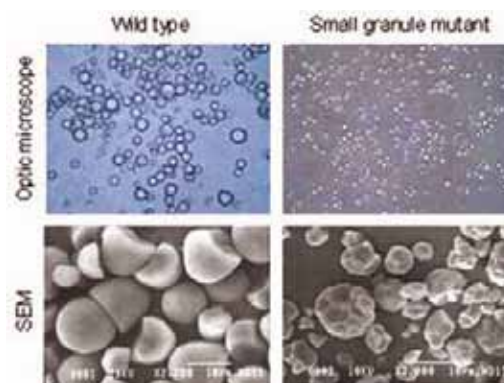

Figure 1 Microscopic (transmission and scanning electron) comparison of starch granules between the WT and small granule mutant of cassava.

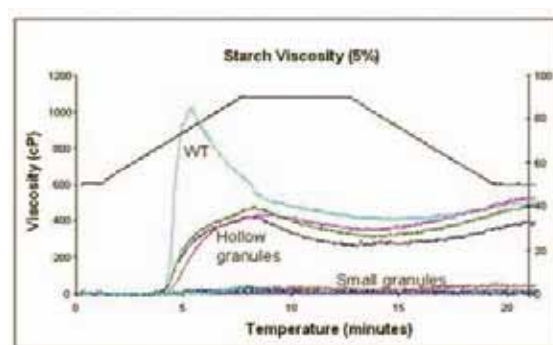

Figure 2 Amylograms of WT and various mutants of cassava.

The most outstanding difference in the amylograms relates to the very low viscosity of SGM (peaks ranging only from 19 to 76 cP compared to 976 to 1080 cP in WT cassava). This striking difference is clearly illustrated in Fig. 2. Hot and cool paste viscosities, breakdown, setback

and consistency were very low and difficult to quantify in the almost flat amylograms of SGM (Fig. 2). Another interesting observation was that the average amylose content in SGM using the colorimetric method ranged from 28-36%, a considerably higher value compared with the 20-22% values observed in the WT genotypes presented in Table 2 or the average of 20.7% obtained after the analysis of more than 4,000 cassava genotypes [19]. Paste clarity was also much lower in SGM (13-26%) compared with WT starch (59-64%).

Table 2. Analysis of the starches from SGM and three WT genotypes. Data from one SGM came from a seedling plant (March 2006 harvest) and five cloned plants in later harvests. Analyses for these five plants were made individually so SD (in brackets) values could be provided. For the second SGM (5G160-16), only data from the seedling plant is available. Peak viscosity and pasting temperatures are based on 5% starch suspensions.

Parameter	Seedling			Cloned		
	5G 160-16	5G 160-13	5G 160-13	MTAI 8	MCOL 1505	MNGA 11
Average granule size (μm) (St. Deviation)	n.a.	n.a.	5.80 (0.327)	16.17 (0.086)	18.73 (0.099)	13.97 (0.118)
Paste clarity (%) (St. Deviation)	17	26	13 (1.18)	63 (1.76)	63.5 (0.14)	58.7 (1.06)
Amylose (%) (St. Deviation)	36.23	28.49	30.07 (0.87)	20.67 (1.62)	22.18 (0.76)	22.6 (0.60)
Pasting temperature in $^{\circ}\text{C}$ (St. Deviation)	67.4	67.15	60.17 (1.06)	64.23 (0.53)	61.60 (0.49)	63.55 (0.07)
Peak viscosity in cP (St. Deviation)	44	76	22 (4.5)	976 (2.82)	1052 (6.36)	1080 (4.94)
Solubility (% db) (St. Deviation)	33.83	37.17	36.84 (0.67)	10.15 (0.03)	12.20 (0.73)	8.34 (0.55)
Swelling Index (g g^{-1}) (St. Deviation)	16.45	14.19	9.25 (0.26)	21.77 (0.44)	27.92 (0.57)	26.55 (0.66)
Volume fraction dispersed phase (Φ) (St. Deviation)	0.32	0.28	0.66 (0.66)	0.70 (0.002)	0.72 (0.002)	0.68 (0.009)

A preliminary screening for the most likely cause of the small granule SGM was conducted for two candidate enzymes: starch branching enzyme (SBE) and isoamylase (ISA). The activities of SBE and ISA were assayed using native gels. The native gel analysis also gave information about the activities of other enzymes [18]. These preliminary results suggested that the SGM does not lack SBE, one of the common causes of a high-amylose phenotype in mutants of other species. However, a consistent difference between WT and SGM in the banding pattern of isoamylase on native gels was observed. Whether the changes in ISA bands shown here for the cassava SGM are due to a lesion in an isoamylase gene or due to secondary effects remains to be determined. Other enzymes such as starch synthase are potential sites for the mutation in cassava and will also be investigated after the next harvest. In addition to isoamylase, other enzymes (pullulanase, disproportionating enzyme, and α -glucan water dikinase) have also been related to amylopectin biosynthesis in different crop species and are also potential site(s) of the observed mutation. Although on native gels of the mutant no effect on SBE activity could be observed, this enzyme cannot be entirely ruled out at this stage. TILLING [20] using primers from as many as 16 different enzymes known to be related to starch biosynthesis is also underway. Until further information is produced, the tentative site of the lesion causing this mutation is in one of the isoamylase genes.

A remarkable feature of this mutation is that two totally independent events with the same phenotype have been identified (5G160 and 3G43), in a relatively small population of about 800 M_2 genotypes from which roots could be harvested and starch extracted. After an extensive evaluation of the cassava germplasm collection at CIAT (more than 4,000 genotypes) in no case has such SGM phenotype been reported, including in the female progenitor of 3G43 (MCOL 1505). A large number of

cassava genotypes (including MCOL 1505) have been self-pollinated in search of useful recessive traits [13], and SGM has not been observed in any of these S_1 families either. Also very important is the fact that only one M_1 genotype from the many representatives of families C4 and SM3015 produced M_2 plants with the SGM phenotype. If the mutation was already carried by one of the progenitors of these families, it should have surfaced in more than a single lineage of each of these two families. Therefore, a reasonable working hypothesis is that these two SGM phenotypes were created *de novo*, as a result of the irradiation of the botanical seed. The effect of irradiation overlaps and confounds with the normal genetic segregation that made each botanical seed unique and different from each other. To rule out the possibility that progenitor(s) of each of the two families whose seed was irradiated (C4 and SM 3015) were already carrying the mutation, they were retrieved and self-pollinated. Several of the potential male progenitors in the open-pollinated SM 3015 family will also be recovered.

The higher-than-normal level of amylose in the small-granule mutation has important commercial implications. Increased amylose levels lead to slowly digestible and resistant starches, which have distinctive advantage in health, particularly in diabetes management and other industrial uses [21, 22]. Crosses between the two different SGM have been made. Since they are genetically unrelated, the resulting F_1 cross will not have the negative effects of inbreeding observed in the M_2 cloned genotypes currently available, and may produce reasonable yields. Moreover, the F_1 crosses will be segregating for many loci, including those causing the small-granule phenotype (in case the mutations in 5G160 and 3G43 affected different loci). This segregation could allow selecting for amylose levels higher than the maximum level of 36% already observed in one of the quantifications made in this study.

Alternatively, the starch granule characteristics of SGM may have other commercial applications. The reduced granule size and the obvious irregularities in their surface (Figure 2) would lead to a facilitated hydrolysis [23], thereby offering advantages for the bio-ethanol industry. It is acknowledged, however, that while the starch granule appearance would facilitate bio-ethanol production, the higher proportion of amylose would tend to make it less efficient. Only when proper fermentation studies are conducted, the relative importance of these contrasting and opposed trends will be clarified. A similar problem has already been analyzed for starches from other crops [23].

Tolerance to post-harvest physiological deterioration (PPD)

The processes involved in PPD resemble typical changes associated with the plant's response to wounding that triggers a cascade of biochemical reactions, which are frequently oxidative in nature. Specific genes involved in PPD have been identified and characterized, and their expressions evaluated [9, 24, 25]. As a consequence, there are several potential loci where the induction of mutations could result in the alteration of this cascade of biochemical reactions. It is therefore, not surprising that, in preliminary evaluations, five different genotypes have shown tolerance to PPD: two M_2 genotypes from family C4 (5G108-3 and 5G108-4), two from family SM 3045 (4G77-4 and 4G77-5), and a single genotype from family GM155 (2G15-1).

Reaction to PPD is difficult to assess. PPD is influenced by environmental conditions [26] and cultural practices [11]. Root to root variation in PPD, even when they have been harvested from the same plant can be high. The preliminary evaluations made on few roots harvested from "seedling plants" and the first cloned generation, needs further confirmation. A total of 67 plants from the five cloned genotypes were grown in the field and were supposed to be harvested in March 2008. Unfortunately, weather conditions during the 3-4 months prior to the harvest were unusually wet, resulting in generalized root rots and atypical root quality conditions that made the assessment of the reaction to PPD unreliable. Further confirmation for these phenotypes will have to wait until March

2009. PPD implies high marketing costs for cassava roots and causes frequent losses. The logistic complications derived from having to consume or process cassava roots within one or two days after harvest are severe. Therefore, any action directed towards an alleviation of PPD would have very significant and positive impact on the livelihood of millions of people who depend on this crop, either producing or processing it [27].

Hollow-granule phenotype

Genotype 2G28-9 (from family GM155) showed atypical starch granule morphology. Granules looked empty or hollow inside. Unfortunately, this genotype was very weak and produced little amount of starch for extensive evaluation. Amylograms showed a pasting property with an intermediate viscosity peak (Figure 2), but this kind of behavior is not totally unusual and similar viscosity curves have been observed occasionally before although they were not necessarily linked to a “hollow granule” phenotype. The heavy rains before the harvest of March 2008 did not help to harvest enough roots for adequate starch extraction to perform extensive analyses on the properties of this suspected mutation.

Starchless / sugary phenotype

A fourth unusual phenotype was identified during the early screening of the M₂ generation. Genotype 5G190-11 from family C4 failed to produce roots with the normal levels of starch. In fact, it was very difficult to extract any starch even from the cloned plants harvested in March 2007. Carvalho and co-workers [14] described a landrace in cassava, which produces very little starch (<3%). However, the roots of this interesting group of “sugary” cassava landraces have high levels of free sugars (mostly glucose) and a glycogen-like molecule. The roots from these genotypes have reduced levels of amylose as well. As for the previous mutations, a large number of roots are required for the proper characterization of this putative starch mutation. Because of the limited amount of starch they contain and the environmental conditions during the harvest in March 2008 which did not allow an adequate production of roots, further studies on this mutation will have to wait until the harvest in March 2009.

Conclusions

At least four different root or starch phenotypes have been identified. One of them has already been confirmed and fully characterized [18]. Relevant to the understanding mutation induction, genetic lesions and DNA repair mechanisms, is the fact that the SGM may be a high-frequency event either because locus or loci involved are particularly susceptible to radiation damage, or else because repair mechanisms are more relaxed for this kind of locus/loci given the relatively neutral impact for the fitness of the genotypes carrying the mutations (little selective disadvantage). Given the frequency of mutations affecting amylose and amylopectin biosynthesis and their relative contents in cereals, potato and sweet potato, this hypothesis may be true not only for cassava but for these other crops as well.

The other mutations need further confirmation and characterization. PPD tolerance, if confirmed, would imply a breakthrough discovery given the huge and negative economic implications of PPD. For decades cassava researchers worldwide have been searching for a solution to this problem [27]. Induction of “sugary” cassava, if confirmed, is more relevant from the scientific (suggesting also the possibility of a high frequency mutation rate for the involved loci) than from the economic perspective, considering that sugary phenotypes already exist [14]. The relevance of the “hollow granule mutation” can only be assessed after it has been confirmed and starch quality characteristics properly evaluated.

As in the case of other crops the induction of mutations in cassava through irradiation with Gamma-rays has proven to be an effective tool for the development not only of germplasm suitable for basic research but also capable of offering important benefits in the livelihood of farmers and processors of cassava.

BIBLIOGRAPHY

1. Allem, A.C. The origins and taxonomy of cassava. In: Hillocks, R.J. *et al.* (Eds.), *Cassava: biology, production and utilization*. CABI Publishing, England, p.1-16 (2002).
2. Olsen, K.M., Schaal, B.A. Microsatellite variation in cassava (*Manihot esculenta*, Euphorbiaceae) and its wild relatives: further evidence for a southern Amazonian origin of domestication. *Amer. J. Bot.* **88**, 131-142 (2001).
3. Bokanga, M. Processing cassava leaves for human consumption. *Acta Horticulturae* **375**, 203-207 (1994).
4. Kawano, K. *et al.* Yield improvement in a multistage breeding programme for cassava. *Crop Sci.* **38**, 325-332 (1998).
5. Nweke, F. New challenges in the cassava transformation in Nigeria and Ghana. EPTD discussion paper No. 118. Environment and Production Technology Division, International Food Policy Research Institute. Washington, D.C. USA (2004).
6. Dixon, A.G.O. *et al.* Cassava: from poor farmers' crop to pacesetter of African rural development. *Chronica Horticulturae* **43**, 8-15 (2003).
7. Ceballos, H. *et al.* Cassava Genetic Improvement. In: Kang, M.S., Priyadarshan, P.M. (Eds.), *Breeding Major Food Staples*. Blackwell Publishing, USA, p. 365-391 (2007).
8. Kakes, P. Properties and functions of the cyanogenic system in higher plants. *Euphytica* **48**, 25-43 (1990).
9. Reilly, K. *et al.* Towards identifying the full set of genes expressed during cassava post-harvest physiological deterioration. *Plant Mol. Biol.* **64**, 187-203 (2007).
10. Rickard J.E. Physiological deterioration of cassava roots. *J Sci Food Agric* **36**, 167-176 (1985).
11. van Oirschot, Q. *et al.* The effect of pre-harvest pruning of cassava upon root deterioration and quality characteristics. *J Sci Food Agric* **80**, 1866-1873 (2000).
12. Ceballos, H. *et al.* Development and Identification of High-Value Cassava Clones. *Acta Horticulturae* **703**, 63-70 (2006).
13. Ceballos, H. *et al.* Discovery of an amylose-free starch mutant in cassava (*Manihot esculenta* Crantz). *J Agric Food Chem* **55**(18), 7469-7476 (2007).
14. Carvalho, L.J.C.B. *et al.* Identification and characterization of a novel cassava (*Manihot esculenta* Crantz) clone with high free sugar content and novel starch. *Plant Mol Bio* **56**, 643-659 (2004).
15. Ahloowalia, B.S. *et al.* Global impact of mutation-derived varieties. *Euphytica* **135**, 187-204 (2004).
16. Maluszynski, M. *et al.* Heterosis in crop mutant crosses and production of high yielding lines using double haploid systems. *Euphytica* **120**, 387-398 (2001).
17. Aristizábal, J., Sánchez, T. Guía técnica para producción y análisis de almidón de yuca. Boletín de Servicios Agrícolas de la FAO. Roma, FAO (2007).
18. Ceballos, H. *et al.* Induction and identification of a small-granule, high-amylose mutant in cassava (*Manihot esculenta* Crantz). *J Agric Food Chem* **56**(16), 7215-7222 (2008).
19. Sánchez, T. *et al.* Screening of starch quality traits in cassava (*Manihot esculenta* Crantz). *Starch/Stärke* (In press)
20. Till, B.J. *et al.*, Large-scale discovery of induced point mutations with high-throughput TILLING. *Genome Res.* **13**, 524-530 (2003).
21. Davis, J.P. *et al.*, Synthesis of novel starches in planta: opportunities and challenges. *Starch/Stärke* **55**, 107-120 (2003).
22. Jobling, S. Improving starch for food and industrial applications. *Current Opinion in Plant Biology* **7**, 210-218 (2004).
23. Lehman, U., Robin, F. Slowly digestible starch – its structure and health implications: a review. *Trends in Food Sci. & Technology* **18**, 346-355 (2007).
24. Uritani, I. *et al.* Biochemistry of postharvest deterioration of cassava and sweet potato roots. In: URITANI, I. *et al.* (Eds.) *Tropical Root Crops: Postharvest Physiology and Processing*, Japan Scientific Societies Press. Tokyo, p.61-75 (1984).
25. Cortés D.F. *et al.* Mapping wound-response genes involved in post-harvest physiological deterioration (PPD) of cassava (*Manihot esculenta* Crantz). *Euphytica* **128**, 47-53 (2002).
26. Sánchez, T. *et al.* Reduction or delay of post-harvest physiological deterioration in cassava roots with higher carotenoid content. *J Sci Food Agric* **86**(4), 634-639 (2005).
27. International Fund For Agriculture Development (IFAD) And Food And Agriculture Organization Of The United Nations (FAO). *Cassava Global Development Strategy*. Rome, Italy (2000).

Application of Induced Mutation Techniques in Ghana: Impact, Challenges and the Future

K E Danso^{1,*}, O Safo-Katanka², Y Adu-Ampomah³, V Oduro¹, H M Amoatey¹, D K Asare¹, E Ofori Ayeh¹, G Amenorpe¹, S Amiteye¹ & Y Lokko⁴

Abstract

Over two decades of application of induced mutation techniques toward crop improvement in Ghana have led to the production of improved mutant varieties in two crops. In cassava (*Manihot esculenta* Crantz), irradiation of stem cuttings using gamma irradiation resulted in the production of “Tek bankye,” a mutant variety with high dry matter content (40%) and good poundability from the parental line which was a segregant of a hybrid between the Nigerian landrace Isunikaniyan (ISU) and the breeder’s line TMS 4(2)1425, both from IITA, Nigeria. Similarly, irradiation of vegetative buds of ‘Amelonado’ (P30), ‘Trinitario’ (K5) and ‘Upper Amazon’ (T85/799) cocoa varieties resulted in the production of Cocoa Swollen Shoot Virus (CSSV)-resistant mutant variety. Multi-locational on-farm trials of the mutant line indicate significant increases in yield by farmers with no symptoms of the disease. Despite these achievements, application of induced mutation in Ghana has been challenged by low funding, inadequate statistics on small-holder farms, high attrition rate of researchers, low rate of useful mutant regeneration and lack of indicators for early mutant selection. Recent advances in plant breeding, which combine *in vitro* techniques with mutation induction hold better prospects for generating useful mutants.

Introduction

Mutation induction is a useful technique in plant breeding used to improve traits without disrupting the original genetic constitution of the crop [1]. It has been used extensively in the improvement of several crops, especially vegetative propagated species without extensive hybridization and backcrossing. Mutation breeding has led to release of more than 2,250 plant varieties in the past 70 years [2, 3].

The application of nuclear techniques in Ghana dates back to the mid-1980s. Research efforts in various plant breeding programmes have used these techniques to develop improved varieties of several food crops including cassava, yam, plantain, banana, oil palm, winged bean and cocoa.

Whereas most of these programmes yielded no useful mutants, a few have been successful, having a positive impact on farmer output with a highly significant improvement in the general economy of the nation. This paper reports the achievements made in induced mutation breeding over the past 20 years in the face of frustrating challenges, and also examines the continued application of the technique in future breeding programmes.

Historical perspective

The establishment of the Department of Biology, Food and Agriculture (now Biotechnology and Nuclear Agriculture Research Institute) in the

Ghana Atomic Energy Commission in the early 1980s marked the beginning of the application of nuclear techniques in crop improvement in Ghana. Early scientists were trained by the International Atomic Energy Agency (IAEA) in Vienna and in Italy to acquire basic skills in the use of physical and chemical mutagens through Technical Cooperation projects. The training was later extended to other scientists in universities and research institutions in Ghana. The acquisition of these skills provided the impetus for the commencement of efforts at the induction of mutations for improvement of several food crops including yam, plantain, cocoyam, oil palm, coconut, winged bean, African Yam bean, bambara groundnut, groundnuts and maize. Beside the establishment of the LD50 for various plant parts and plant regeneration protocols in the case of pineapple [4] and cocoyam [5], the initial enthusiasm did not result in the release of mutant varieties. Furthermore, there is no peer-reviewed documentation on the outcomes of most of these programmes, suggesting that they were truncated for one reason or another. In the case of cassava and cocoa, results have been well documented by [6,7] and [8], respectively.

Induction of mutation in cassava

Cassava is a staple food crop in Ghana, used for human consumption in various forms. Systematic breeding of cassava was initiated in 1930 when the Cassava Mosaic Virus Disease (CMD) was first observed in the country [9]. Use of local landraces in a hybridization programme with exotic varieties imported from other West African countries and the Caribbean led to the production and release of four varieties, namely, Queen, Gari, Williams, and Ankrah which were high yielding, of good taste and highly resistant to the CMD (ACMV). However, resistance to CMD broke down in all except Ankrah, which later succumbed to the disease due to increased vector population and probably the resurgence of other strains of CMD virus by 1950. Later, another set of four varieties, namely, K357, K162, K680 and K491 were released as a result of hybridization between local varieties and four closely related *M. esculenta* species [9].

Incorporation of mutagenesis in the cassava improvement programme began in the 1980s. In 1984, seeds of two high-yielding cassava varieties Isunikaniyan or TME117 (ISU) a landrace from Western Nigeria and the improved breeders line, TMS 4(2)1425 introduced from IITA, Nigeria, served as parents for mutation induction using gamma radiation to improve the poundability (mealiness, elasticity and smoothness of the pounded paste). In 1988, cuttings from the ISU X TMS 4(2)1425 F₁ plants were irradiated at 25 and 30Gy Gamma-rays. Selection at the M1V4 stage produced a mutant line with good poundability, high dry matter content (40%) and low incidence of CMD (Tables 1 and 2). This was adopted as a new variety after a series of multi-locational trials and officially released in 1997 by the Ministry of Food and Agriculture known as “Tek bankye.”

Cocoa development in Ghana

Since its introduction in 1878, cocoa has been a major foreign exchange earner playing a key role in the national economy with about 17% of the

¹ Ghana Atomic Energy Commission, Biotechnology and Nuclear Agriculture Research Institute, Department of Plant and Soil Sciences, P.O. Box 80, Legon-Accra, Ghana.

² Department of Crop Science, Kwame Nkrumah University of Science and Technology, Kumasi.

³ Cocoa Research Institute of Ghana, P. O. Box 8, New Tafo-Akim, Ghana.

⁴ Plant Breeding and Genetics, Joint FAO/IAEA Division, International Atomic Energy Agency (IAEA), Wagramer Strasse 5, PO Box 200, Vienna, Austria

* Corresponding author. E-mail: kaedanso@hotmail.com

country's labor force depending on it for the family budget. The rapid expansion of the cocoa industry in the early 1900s declined in the 1980s due to climatic changes, bushfires and other socio-economic factors. In addition to these factors, the cocoa industry was seriously constrained by the black pod disease caused by *Phytophthora palmivora* and *P. megakarya* and the cocoa swollen shoot virus disease (CSSV) transmitted by the mealy bug *Planococcoides njalensis* (Laing) [10]. The CSSV disease could not be controlled either by chemicals [11] or biological methods [12]. Earlier attempts to eradicate the disease by removal of infected trees from their symptomless neighbors [10], which initially proved successful, also failed after over 190 million infected trees had been removed [13]. Thus, genetic improvement of the crop to produce resistant CSSV varieties remained the most suitable option for the control of the disease.

Table 1. Tuber yield, cooking quality and cassava mosaic disease (CMD) incidence of cassava varieties

Variety	No. of tubers/plant	Tuber yield/plant	CMVD* incidence	Cooking quality		
				Fufu Mealiness	Ampesi Elasticity	Gari
Abasa Fitaa	5.3	25.1	0.8	2.3	2.3	2.9
Afisiayi	7.4	28.8	0.8	1.0	1.0	3.0
Gblomoduade	7.4	42.6	1.6	1.0	1.0	3.0
ISU-W	5.7	27.0	0.5	2.5	2.0	2.9
Local Variety	4.8	15.5	2.8	2.5	2.5	2.9
C.V.	16.8	27.2	2.4	30.9	36.1	8.2
L.S.D.	1.0	7.6	0.6	0.6	0.6	0.67

Source: Asare and Safo-Katanga [6]. Note: Score of CMD: 0-3, None- very heavy incidence.

Table 2. Root tuber yield of cassava varieties in different locations

Variety	1	2	3	4	5	6	7	8
Abasa fitaa	22.2	23.6	15.4	18.0	16.0	49.4	30.4	26.0
Gblemoduade	25.8	26.8	20.6	56.0	44.8	90.0	48.5	28.5
Afisiayi	22.7	28.1	13.2	32.0	34.0	60.4	25.0	15.5
ISU-W (Mutant)	27.8	18.0	13.0	35.0	25.2	58.7	24.3	14.1
Local variety	14.8	9.8	11.7	12.0	13.5	36.3	15.3	11.0

Source: Asare and Safo-Katanga [6]. Locations: 1- Duase; 2-Akomadan; 3-Of-fino; 4-Datoyili; 5-Nyeshie; 6-Subinso; 7-Techiman; 8-Nkoraza.

Development of hybrid cocoa variety

Genetic improvement of cocoa in Ghana has included introductions of exotic varieties, conventional hybridization and induced mutations. According to [14] there have been seven cocoa varietal releases dating from as far back as 1887 (Table 3).

Mutation induction for improvement of cocoa started in the 1980s when vegetative buds of three cocoa varieties, 'Amelonado' (P30), 'Trinitario' (K5) and 'Upper Amazon' (T85/799) were irradiated with 15, 20 and 25Gy of Gamma-rays, respectively and budded on to root-stocks to generate MV1 shoots. At MV3, shoots were screened for Cocoa Swollen Shoot Virus (CSSV)-resistance by infecting developing shoots with strain 1A of CSSV, and screened for resistance to the virus using patch-graft inoculation and enzyme-linked immunosorbent assay (ELISA). Mutant lines were selected and budded to produce MV4 and again indexed for resistance and multiplied to produce MV5. MV5 mutant lines with high yield and producing good quality beans have been planted in multi-locational on-farm trials in farmers fields for over 10 years with no symptoms of the CSSV virus disease.

Table 3. Stage in cocoa varietal development programme in Ghana.

Variety no.	Variety name	Parent	Source	Extension period	Years to bearing
"Traditional varieties"					
1	Amelonado	Amelonado	Equatorial Guinea	Before 1887	6-8
2	Trinitario	Trinitario	Trinidad, Jamaica, Venezuela	1900-1909	6-8
3	Mixed Amazon	Mixed Amazon	Peru via Trinidad	1950s	5-6
4	Original Series II Hybrids	Upper Amazon x Amelonado and local Trinitario	Peru and WACRI	1966-1970	4-6
5	Modified Series II	Upper Amazon x Amelonado hybrids	WACRI	1971-1985	2-3
"New Varieties"					
6	BRT collection	Inter-Amazon	British Research Team	Mid-1980s	2-3
7	Mutant Hybrids	Irradiation techniques	Current CRIG collections	1990s	4

Source: Edwin and Masters [14].

The challenges

Although the impact of induced mutations has been highly significant, it has not been without challenges. One major constraint has been the low level of efficiency of mutant production resulting in screening of large populations of both cocoa and cassava for mutant selection. For instance, between 1,500 to 3,050 individual cassava and cocoa seedlings respectively were screened at various stages for screening and selection of high-yielding mutants. Although mutation breeding is considered to be cheap and easy to use, with the minimum recommended planting space at 1x1m for cassava and 3x3m for cocoa, the cost involved in handling such large populations is high and may hinder progress.

This problem is further compounded by the absence of efficient screening methods *in vitro*, or earlier in the seedling nursery stages due to the absence of simple phenotypic markers for the desired traits, and either lack of or inadequate biotechnology and/or molecular biology facilities at the early stages of the breeding programme. Until recently, molecular biology equipment was lacking and thus their application for mutant selection was limited. Both crop plant species used for mutation induction are heterozygous vegetatively propagated crops and may carry undesirable traits, which may need three or four generations of selfing before homozygous lines are produced.

There is also no data available to assess the direct economic impact of the mutants produced both at the small-holder farmer and at a national level. Thus, the direct benefit from mutation breeding cannot be assessed. In the case of cassava, it is extremely difficult to determine the contribution of the "Tek bankye" mutant to food security in the country. Similarly, the Mutant Vegetative bud 5 (MV5) is currently being extended to farmers in the Eastern region; it is very difficult to estimate its economic benefit to farmers involved in the planting of this mutant.

Another major bottleneck to mutation breeding in Ghana is the low level of funding allocated for research. This problem is also compounded by the wrong perception that people had of the use of nuclear energy. The implication of this wrong perception is enormous as it often hinders policy decisions on the use of nuclear techniques, as well as release of funds to replace expired or weak gamma irradiation sources.

Future prospects

In spite of these bottlenecks, the use of induced mutation has a bright future as the technique continues to be a cheap and the only option for

breeding vegetatively propagated crops. Additionally, the combination of induced mutation with *in vitro* cell culture may resolve the problem of early selection, thereby making the technique attractive.

BIBLIOGRAPHY

1. Sleper, D.A., Poehlman J.M. *Breeding Field Crops*, 5th Edition, Blackwell Publishing, Iowa (2006).
2. Maluszynski, M., Nichterlein, K., Van Zanten, L., Ahloowalia, B.S. Officially released mutant varieties—The FAO/IAEA Database, *Mutation Breeding Review* **12**, 1-84 (2004).
3. Ahloowalia, B.S., Maluszynski, M., Nichterlein, K. Global impact of mutation-derived varieties. *Euphytica* **135**(2), 187-204 (2004).
4. Lokko Y., Amoatey, H. Improvement of pineapple using *in vitro* and mutation breeding techniques. In: *In vitro* techniques for selection of radiation induced mutations adapted to adverse environmental conditions. Proceedings of a final Research Co-ordination Meeting organized by the Joint FAO/IAEA Division of Nuclear Techniques in Food and Agriculture and held in Shanghai, China, 17–21 August 1998. IAEA-TECDOC-1227 pg 25–31. http://www.pub.iaea.org/MTCD/publications/PDF/te_1227_prn.pdf.
5. Blay E.T., Offei, S.K., Danquah, E.Y., Amoatey, H.A., Asare, E. Improvement of cocoyam (*Xanthosoma sagittifolium*) using gamma irradiation and tissue culture. In: Genetic improvement of under-utilized and neglected crops in low income food deficit countries through irradiation and related techniques. Proceedings of a final Research Co-ordination Meeting organized by the Joint FAO/IAEA Division of Nuclear Techniques in Food and Agriculture and held in Pretoria South Africa, 19–23 May 2003 IAEA-TECDOC-1426 pg 127–130. http://www.pub.iaea.org/MTCD/publications/PDF/te_1426_prn.pdf.
6. Asare, E., Safo-Katakanka, O. Improvement of cassava cooking quality through mutation breeding. Improvement of basic food crops in Africa through plant breeding, including the use of induced mutations. IAEA-TECDOC-951, Vienna (1997).
7. Ahiabu, R.K. *et al.* Mutagenesis for ACMV resistance in a Ghanaian cassava cultivar “Bosom nsia”, Improvement of basic food crops in Africa through plant breeding, including the use of induced mutations. IAEA-TECDOC-951, Vienna (1997).
8. Adu-Ampomah, Y., Owusu, G.K., Sackey, S., Padi, B. Use of gamma rays to induce mutants resistant to cocoa swollen shoot disease in *Theobroma cacao* L. *Plant Breeding* **115**, 74-76 (1996).
9. Anonymous. FAO Corporate Document Repository, A country case study of Cassava Development in Ghana prepared by the Ministry of Food and Agriculture, (2008).
10. Bowman, J.S., Casida, J.E., Systemic insecticides for *Theobroma cacao* L., their translocation and persistence in foliage and residue in cocoa beans. *J. Econ. Entomol* **51**, 773-780 (1958).
11. Donald, R.G. Mealy bug studies: introduction of exotic parasites, Annual Report WACRI 1954/55, p.49 (1945).
12. Posnette, A.F. Control measures against swollen shoot virus disease of cocoa. *Trop. Agric.* **20**, 116-123 (1943).
13. Ollenu, L.A., Hughes, J. Assessment of the current swollen shoot disease situation in Ghana, Annual Report, Cocoa Research Institute, Ghana, 96-97 (1991).
14. Edwin, J., Masters, W.A. Genetic improvement and cocoa yields in Ghana. *Expl. Agric* **41**, 1-13 (2005).

Molecular Characterization of Somatic Mutation in *Musa acuminata* 'Red'

A S Nair^{1,*}, T Schwarzacher² & J S (Pat) Heslop-Harrison²

Abstract

Musa acuminata 'Red' (AAA) is a South Indian dessert banana cultivar ($2n = 3x = 33$) with a characteristic red color in the pseudostem, petiole and fruit peel. Red banana undergoes the process of somaclonal variation, producing the 'off types' *Musa acuminata* 'Green' cultivars. The frequency of the production of this 'green variant' is high during *in vitro* multiplication. In plants, anthocyanin pigments are assembled from phenyl alanine and acetyl CoA by the enzyme chalcone synthase (CHS). To understand the molecular mechanism for the somaclonal variation in Red banana, the chalcone synthase gene sequences were amplified using PCR products and sequences were compared with those of 'Green variants (AAA)', 'Dwarf Cavendish (AAA)' and diploid 'Pisang lilin' (AA). Sequence variations were observed only in amplified product from Red cultivar. Predicted amino acid sequences of the longest ORF indicated changes in seven amino acids such as arginine, glutamine, alanine, aspartic acid, isoleucine, phenylalanine and asparagine to serine, leucine, proline, alanine, valine, tyrosine and serine respectively. *Musa acuminata* cv. Red with anthocyanin content might have originated as a natural mutant, selected and maintained by vegetative propagation through generations.

Introduction

Musa acuminata 'Red' has originated as a backyard clone of dessert banana in South India. It is cultivated in the states of Maharashtra, Tamil Nadu and Kerala [1]. Cultivation of red banana has also been reported from Indonesia, Papua New Guinea, Eastern Australia, Fiji, Samoa, Hawaii, Philippines, Thailand, Myanmar, Sri Lanka, East Africa, the West Indies and continental America. The plants are tall and vigorous, slightly susceptible to Panama disease, and resistant to leaf spot disease. The fruit bunch in red banana is compact and bears 50 to 100 red rind fruits that are good in size, slightly curved and possess a blunt apex. The fruits do not easily fall off from the pedicel. The pulp is cream-colored and has a characteristically strong flavor. Because of the attractive size and coloration, the fruits always fetch high prices in the local markets.

The cultivar is named 'Red' because of its very distinctive color in the pseudostem, petiole, midrib and in the fruit rind. The epidermal peels from petiole showed characteristic accumulation of anthocyanin pigments in the vacuoles of parenchymatous cells in the sub epidermal layer. In nature, the red cultivar rarely produces green suckers; while the reverse change from green to red has never been recorded [2]. *In vitro* propagation of the red cultivar on MS medium with 8mg/l BA increased the shoot multiplication rate as well as the frequency of the green variants [3]. The green variants produced green fruits that on ripening turned yellow, with low market demand. In this study, our primary goal was to understand whether red banana is a chimera consisting of red skin on a green core and variegation results from developmental accidents rather

than mutation. Chalcone synthase (CHS) is involved in the beginning of anthocyanin biosynthesis. Molecular analysis CHS sequences of Red and Green cultivars were carried out to investigate if any changes in the gene are linked to red banana.

Materials and Methods

Musa acuminata Red (AAA), Green variants (AAA), Dwarf Cavendish (AAA) and Diploid (AA) cv Pisang lilin were selected in the present study. While 'Red' has red coloration in the pseudostem, petiole and fruit rind, the other three have green colored pseudostems, petioles and fruits. In Red cultivars the fruits remained red even after ripening, whereas in others the green fruits turned yellow on ripening.

Genomic DNA was isolated from young leaves of field grown plants (Banana Agriculture station, Peringamala, Kerala, India), packed in plastic bags and kept in ice-boxes for two days before DNA extraction. DNA was extracted using a modified CTAB (hexadecyltrimethylammonium bromide) method [4]. The percentage of polyvinylpyrrolidone with molecular weight 40,000 (PVP-40 SIGMA) was increased to 6% due to the high phenolic compounds in banana leaves.

The two primers used for PCR amplification reactions were 5'-TCTCCGACGCCTTCAGCACG-3' (forward primer) and 5'-AACATGGAGCGGAGCCTGCG-3' (reverse primer). All PCR reactions were carried out in a final volume of 20 μ l reaction mixture consisting of 100ng DNA, 1X PCR buffer (cat # M 1861, Promega), 1.5 mM MgCl₂, 200 μ M dNTP mix, 10 pmol of each primer and 1U *Taq* polymerase (cat # M 1861, Promega). Amplification was performed using a Biometra T-Gradient (Gottingen) thermocycler. The programme was run for five minutes at 94°C followed by 30 cycles of 60 S at 94°C, 60 S annealing at 56°C and two-minute extension at 72°C. Amplification products were resolved in 1.5% agarose gels. The products obtained from the gel were purified using QIAquick gel extraction kit (QIAGEN, cat # 28706). Purified products were cloned in the pGEM Teasy vector system 1 (Promega, cat # A1360). Cloned products were sequenced commercially using an ABI3700 capillary sequencer and compared with GeneBank sequences using NCBI BLASTN services. The similarities between the sequences were studied using ClustalW multiple sequence alignment programme (www.ebi.ac.uk).

Results and Discussion

The PCR produced single bands of ~500 bp in size (Fig. 1). Following the cloning of the PCR products from all samples, the identity of the putative target segments was determined by sequencing followed by a blast search and by alignment with heterologous GeneBank sequences (Fig. 2). The products showed more than 99% homology with products in a *Musa* EST database (C_600145587T1). ClustalW analysis produced multiple sequence alignments of the CHS sequences and calculated the similarities between samples. The neighbor joining tree showed that sequences from Green, Dwarf Cavendish, and Pisang lilin come under a single cluster, whereas the sequence from Red falls into a separate group. When the DNA sequences were translated using the biology workbench

¹ Department of Botany, University of Kerala, Kariavattom, Thiruvananthapuram 695 581, India

² Department of Biology, University of Leicester, Leicester LE1 7RH, United Kingdom

* Corresponding author. E-mail: ashahot2004@yahoo.co.uk

3.2 (<http://workbench.sdsc.edu>), the red cultivar differed in the seven amino acids arginine (R), glutamine (Q), alanine (A), aspartic acid (D), isoleucine (I), phenyl alanine (F), and asparagine (N) to serine (S), leucine (L) proline (P), alanine (A), valine (V), tyrosine (Y), and serine (S), respectively (Fig. 3). The amino acid changes in the ORF obtained from the red cultivar also showed more transversion mutations (Table 1).

Color differences in fruits are easily scorable features of genetic diversity and are important for taxonomic classification. In India, red fruits fetch high prices and color is widely used to assess the market value and quality. Extensive studies in anthocyanin biosynthesis were reported in petunia, snapdragon, and maize [5, 6]. The enzymes in the anthocyanin pathway are encoded by structural genes and regulatory genes control the expression of structural genes in response to environmental stimuli such as light and temperature [6, 7]. Mutations in either structural or regulatory genes can produce mutants with reduced or without pigmentation [8]. The first committed step in the biosynthesis of flavanoides and anthocyanins is catalyzed by chalcone synthase. Four genes encoding CHS have been isolated from Petunia, two from Maize and one from Snapdragon [9]. In banana, the distribution of anthocyanins in the bracts of wild and cultivated varieties separated them into different chemotypes [10], but the molecular analysis of the genes involved in pigment synthesis was not reported. The primers used in this study produced ~500 bp fragment in all the samples and amino acid variation was observed only in the red cultivar, indicating the red cultivar as a genetic variant. Despite the large number of CHS sequences in the Gene Bank database, only the identity of a comparatively small number was verified by heterologous expression [9]. Therefore, several sequences in the data base which are annotated as CHS by similarity may have different metabolic roles.

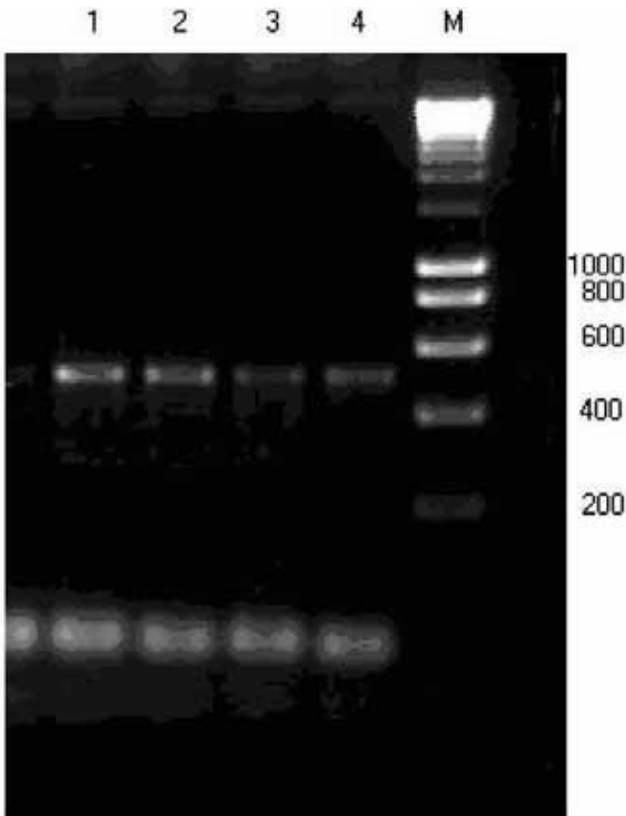

Figure 1 PCR analysis of DNA isolated from young leaves of banana cultivars: lane 1-Red, lane 2- Green variants, lane 3- Dwarf Cavendish, lane 4 Pisang liliin. The numbers to the right indicate the DNA size markers (kb, lane M).

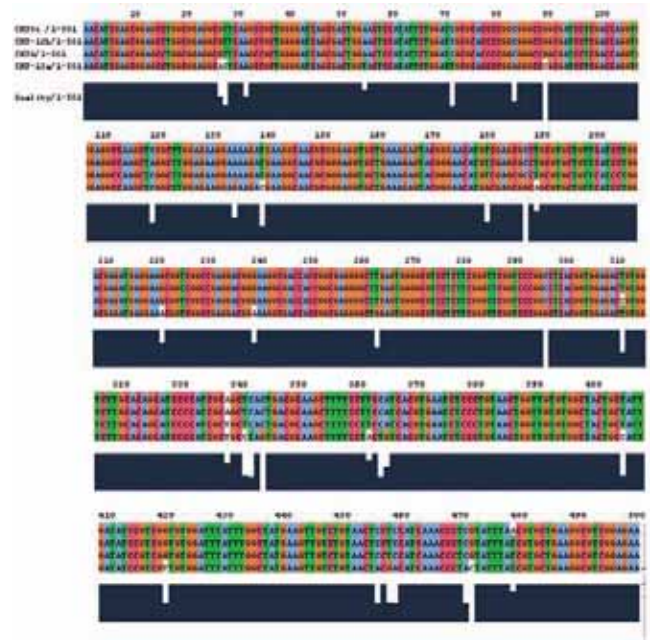

Figure 2 Alignment of 500 bp CHS gene sequences. Chse (Pisang liliin) Chs12b (Green) chsA (Dwarf cavendish) and CHS 13 (Red)

Table 1. Mutational changes in the ORF region in CHS sequences from *Musa* cultivars

Nucleotide position	Genetic code		Base change	Type of mutation	Aminoacid change	
	*Green	Red			Green	Red
39	agg	agc	g→c	Transversion	Arginine	Serine
146	cag	ctg	a→t	Transversion	Glutamine	Leucine
148	gcg	ccg	g→c	Transversion	Alanine	Proline
155	gac	gcc	a→c	Transversion	Aspartic acid	Alanine
198	atc	gtc	a→g	Transition	Isoleucine	Valine
281	ttc	tac	t→a	Transversion	Phenylalanine	Tyrosine
307	aac	agc	a→g	Transition	Asparagine	Serine

* Other three DNA has exactly like the sequences in Green

Anthocyanins are secondary plant products that play a major role as pigments of flowers and fruits. They also protect leaves from ultraviolet radiation [10]. In vegetatively propagated, sterile triploid banana cultivars genome modifications occur through spontaneous mutations. In nucleotide sequence models of evolution, the transition transversion (TI/TV) is an important aspect because it expresses the relative probabilities of different types of nucleotide changes [11]. When a base mutates it can undergo a transition in only one way, but a transversion occurs in two ways. Amongst spontaneous mutations, there are about twice as many transversion mutations as there are transitions. Also, replacement of amino acid proline probably changes the enzyme activity. In proline, the nitrogen atom of the amino group is incorporated into a ring and can cause a sharp transition in the organization of polypeptide. This speculation needs more experimental evidence, however, this study indicates the potential of CHS gene as a molecular marker to study the evolution of *Musa* germplasm.

BIBLIOGRAPHY

1. Singh, H. P. Scenario of banana production, utilization and trade, Souvenir, Global conference on banana and plantain. Oct 28-32, p.1- 17 (2002).
2. Simmonds, N.W. Bananas, Longmans, London, p.57-63 (1958).
3. Vidhya, R., Nair, A. S., Molecular analysis of somaclonal variation in *Musa acuminata* (AAA) cv. Red. *Phytomorphology* **52**(3), 293-300 (2002).
4. Doyle, J.J., Doyle, J.L. A rapid DNA isolation procedure for small quantities of fresh leaf tissue. *Phytochem. Bull.* **19**, 11-15 (1987).
5. Boss, P.K., Davies, C., Robinson, S.P. Analysis of the expression of anthocyanin pathway genes in developing *Vitis vinifera* L. cv. Shiraz grape berries and the implications for pathway regulation. *Plant Physiol.* **111**, 1059-1066 (1996).
6. Holton T.A., Cornish C.E. Genetics and biochemistry of anthocyanin biosynthesis. *The Plant Cell* **7**, 1071-1083 (1995).
7. Kim, S., Yoo, K.S., Pike, L.M. Development of a co-dominant PCR-based marker for allelic selection of the pink trait in onions (*Allium cepa*) based on the insertion mutation in the promoter of the anthocyanidin synthase gene. *Theo. Appl. Genet.* **110**(3), 573-578 (2005).
8. Rausher, M.D., Miller R.E., Tiffin, P. Patterns of evolutionary rate variation among genes of the anthocyanin biosynthetic pathway. *Mol. Biol. Evol.* **16**(2), 266-274 (1999).
9. Horry, J. P., Jay, M., Distribution of anthocyanins in wild and cultivated banana varieties. *Phytochemistry* **27**(8), 2667-2672 (1988).
10. Aras, A., Cevahir, G., Yentür, F., Eryilmaz, Sarsag, M., Cag S. Investigation of anthocyanin localization in various part of *Impatiens balsamina* L. *Biotechnol. & Biotechnol.* **EQ1**, 69-73 (2007).
11. Springob, K., Nakajima, J., Yamazaki, M, Saito, K. Recent advances in the biosynthesis and accumulation of anthocyanins. *Nat. Prod. Rep.* **20**, 288-303 (2003).

Gamma Irradiation-Induced Mutation for the Improvement of Josapine Pineapple Against Bacterial Heart Rot Disease and Improved Fruit Quality

R Ibrahim^{1*}, A Hamzah¹, Z Jan Jam¹, M Bahagia² & M Joyo²

Abstract

Bacterial heart rot disease, caused by *Erwinia chrysanthemi*, is one of the most serious diseases of the susceptible cultivars of pineapple in Malaysia, namely, Josapine, Sarawak, Gandul and N36. Using acute irradiation of Gamma-rays and *in vitro* cultured meristems, selection of resistant mutants to bacterial heart rot disease with improved fruit quality has been carried out in the most popular variety, Josapine. Suckers were collected from the experimental field plot at MARDI Research Station in Pontian Johor. Explants from meristem tissues were transferred to MS (Murashige & Skoog) solid media with 2.5mg/l benzyl aminopurine (BA) and incubated at 23°C at a 16-hour photoperiod. After 10 days in culture, meristem explants were irradiated with a series of Gamma-ray doses of 0, 20, 40, 60, 80, 100, 120, 140 and 160Gy and radiosensitivity was investigated based on shoot formation and survival rate. Radiosensitivity of meristem tissues producing shoots was inversely proportional to the irradiation dose. As the dose was increased mutations appeared more frequently, indicated by the formation of albino and striped leaves. The dose required for 50% lethality (LD₅₀) and 100% (LD₁₀₀) of meristem tissues for shoot formation were 40Gy and 83Gy, respectively. On the other hand, the LD₅₀ and LD₁₀₀ for survival rate were 77Gy and 147Gy, respectively. Suitable doses for mutation induction are suggested in the lower region alongside with LD₅₀ curve, where multiple shoots are regenerated from the irradiated meristem tissues. Therefore, for field screening, four lower doses of gamma irradiation viz. 10, 20, 30 and 40Gy were applied. The limit for shoot induction from irradiated explants generally agreed with the LD₁₀₀ curve. Shoots derived from irradiated meristem explants at 10, 20, 30 and 40Gy were sub-cultured up to M1V5 to minimize chimerism. Multiplication of irradiated shoots was carried out in Temporary Immersion Bioreactor System using MS liquid media with 5 mg/l BA and incubated at 23°C with a 16-hour photoperiod. Rooting of shoots was promoted on MS media with 2 mg/l of Indole-3-butyric acid (IBA). Rooted plantlets measuring 10 to 12.5cm were transplanted to soil-mix in plastic trays for hardening. Mutation of regenerated plants was investigated two months after acclimatization. Preliminary screening of 20,000 irradiated plants in the nursery was first undertaken to select for potential mutants with desired characters, and 60% of the irradiated plants were observed to have smooth leaves and vigorous growth. Hardened irradiated plants with smooth leaves measuring 17.5 to 20cm were field planted in hot spot until fruiting. Potential mutants were selected based on desired characters such as a) resistance to bacterial heart rot disease, b) single crown, c) cylindrical fruit shape with big fruit size and weight, and d) high sugar content. At 10 and 20Gy, there were no potential resistant mutants with a significantly improved total sugar content and fruit weight. However, at higher doses of 30 and 40Gy, 11 and five resistant plants with significant increase in total sugar content and fruit weight were recorded, respectively.

¹ Division of Agrotechnology and Biosciences, Malaysian Nuclear Agency, Bangi, Malaysia.

² Department of Horticulture, Malaysian Agriculture Research Institute and Development (MARDI), Serdang, Malaysia

* Corresponding author. E-mail: rusli_ibrahim@nuclearmalaysia.gov.my

Introduction

The Third National Agriculture Policy stressed that the fruit industry will be expanded to cater the increasing demand for fresh and processed tropical fruits, both for local and export markets. Fifteen fruits have been identified as priority crops for development: banana, papaya, pineapple, watermelon, starfruit, mango, durian, jackfruit, rambutan, citrus, duku langsat/ dokong, cempedak, guava, ciku and mangosteen. The world trade in pineapple is dominated by canned fruit. Some fresh fruit for table consumption is also traded but the volume is small compared with to market for canned fruit. Pineapple in Malaysia is grown for both table consumption and canning, though the majority of production is for canning by far. Pineapple is the most important fruit in terms of revenue earner in this country. There are about 10,000 ha cultivated and half of this is owned by estates and planted for the canning industry. The export of canned pineapple is about two million standard cases annually valued at RM 60 million, while the export of fresh pineapple is about 40,000 ton and worth about RM 10 million. However, the industry for canning an ailing one, with production on the decline since the 1970's.

The current varieties Josapine (fresh fruit) and Gandul (canning) have several weaknesses. For Josapine, improving the resistance to bacteria heart rot and occurrence of multiple-crown will increase production and fruit marketability by 25% in some instances. The estates have complained that Gandul had declined in vigor and yield (from 25 t to 10-13 t/ha) over many years of replanting and a vigorous variety with early 'annual' bearing habit and improved cannery recovery is required to boost the flagging industry. Cannery recovery from 20% currently to 25-28% (close to Cayenne) would significantly improve profits. There is also a shift to a demand for canning in natural juices (30% of current production). But Gandul has low TSS% content and sugar has to be added during canning. A new variety having TSS% of 18% or higher can be processed into a health product in its natural juice with 'no-added-sugars.' Canneries would stand to save at least RM three million annually in sugar input.

Somaclonal variations and induced mutation using irradiation in breeding are least invasive in changes to genetic make-up of an established variety and will be useful for improving the Josapine cultivar. This has proven to be an excellent fresh fruit variety with the exception of two weaknesses: susceptibility to black heart rot and multiple crowns. The use of tissue culture to generate somaclones with minute genetic changes that do not damage the overall varietal identity would be the most suitable tool for improving the variety. This breeding tool has been successfully used for development of several local banana varieties. Recent work by Chan & Lam (2002) has developed protocols to produce Josapine plants by tissue culture. Nuclear techniques using gamma-irradiation that causes small 'point mutations' are employed for the improvement of this variety, with variants that arise from this technique screened for tolerance to heart rot and occurrence of multiple-crown.

The specific research objectives of the programme are: a) to develop a generation of economically important mutations for crop improvement, clonal propagation and field evaluation of mutants that exhibit desir-

able traits such as disease resistance, long shelf-life, resistance to abiotic stresses; b) to overcome major constraints in plant regeneration by tissue culture for large-scale multiplication of desirable induced mutants in order to sustain natural and induced fruit tree biodiversity, leading to improved economic viability of growers and the nutritional component; and c) to access the impact of induced mutants on early fruit bearing, fruit yield, fruit vigor, and quality components (high sugar content for canning, and high cannery recovery rate) depending on the fruit tree life cycle, under field conditions.

Materials and Methods

Establishment of tissue culture protocols for micropropagation

Suckers of cultivar Josapine were obtained from our collaborator, Malaysian Agricultural Research & Development Institute (MARDI) at Pontian Experimental Station in Johor. Outer leaves were removed, roots were cut off and they were excised into small pieces of meristem tissues about 2.0-2.5cm in size. These meristem explants were first rinsed under running tap water for 20 minutes in a beaker added with a few drops of Tween 20 solution. Bacterial contamination is very high using suckers collected from the field, and explants were soaked in 0.3% Mercury chloride for five minutes and then rinsed three times with sterile distilled water. They were then surface sterilized using 20% sodium hypochlorite for 30 min and then rinsed three times with sterile distilled water. These meristem tissues were explanted onto MS media with 0.3% Phytigel and 2.5mg/l benzyl aminopurine (BA) and incubated at 23°C at a 16-hour photoperiod. Cultures were regularly observed for the formation of adventitious buds and *in vitro* shoots for two to three months.

Radio-sensitivity test and *in vitro* mutagenesis

Radiosensitivity test (dose response) for cultivar Josapine was carried out by irradiating meristem explants which had been cultured for 10 days on MS media plus 2.5mg/l BAP with a series of 0, 20, 40, 60, 80, 100, 120, 140 and 160Gy Gamma-ray doses. For each dose, 100 meristem explants were irradiated and divided into five replicates for statistical analysis. Radiosensitivity was determined based on:

1. Percentage survival of irradiated explants
2. Average number of *in vitro* shoots

Irradiated meristem explants were transferred to fresh MS media with 2.5mg/l BAP and incubated at 23°C at a 16-hour photoperiod. Cultures were regularly observed for the formation of adventitious buds and *in vitro* shoots for a period of two to three months. Data on percentage survival of irradiated explants and formation of adventitious buds and *in vitro* shoots was recorded after three months of culture and compared with the control. Effective doses for the main field experiment were selected based on the observed LD₅₀ for both percentage survival of irradiated explants and average number of *in vitro* shoots formed after three months of culture.

Mass propagation of *in vitro* plantlets using bioreactor system

Shoots derived from irradiated meristem explants at selected effective doses were sub-cultured onto fresh MS liquid media supplemented with 2.5mg/l BA in Temporary Immersion Bioreactor System at 23°C with a 16-hour photoperiod up to M₁V₅ generation in order to minimize chimerism.

In vitro rooting of regenerated shoots from M₁V₅ generation was on MS solid medium containing 1% activated charcoal and supplemented with 2.0mg/l Indole-3-butyric acid (IBA), with cultures incubated at 23°C with a 16-hour photoperiod for 30 days. Rooted plantlets measuring from 10.0 to 12.5cm in height were transplanted to soil-mix in plastic trays for hardening in the nursery for a period of two months before

being transferred to the field. Mutated plants were screened and selected for desired characters such as smooth leaves and vigorous growth.

Field screening in hot spot

A total of 20,000 irradiated plantlets regenerated from four selected effective doses of 10, 20, 30 and 40Gy, measuring 10.0 to 12.5 cm in height were acclimatized and hardened in the nursery. During this stage, plantlets with smooth leaves and vigorous growth resulting from mutation were carefully recorded. Hardened irradiated plants with those two traits and measuring 17.5 to 20cm were first isolated and field planted in hot spot. Slow growth irradiated plants with smooth leaves were also transferred to the field when they reached 17.5 to 20cm. Plants with spiny leaves were discarded. Selected irradiated plants together with the controls were grown in hot spot for black heat rot disease until fruiting for a period of 10-12 months after field planting. Potential mutants were selected based on desired characters compared to the control such as a) resistance to bacterial heart rot disease, b) single crown, c) cylindrical fruit shape with bigger fruit size and weight (>1.0kg/fruit), and d) higher sugar content.

Results and Discussion

Establishment of tissue culture protocols for micropropagation

From previous tissue culture work on pineapple, it was known that the use of sodium hypochlorite alone or in combination with ethyl alcohol for surface sterilization was not very suitable since high rate of both bacterial and fungal contaminations occurred (>70%). Pretreatment of meristem explants with 0.3% mercury chloride for five minutes before surface sterilization using sodium hypochlorite was able to reduce contamination rate drastically (>90%).

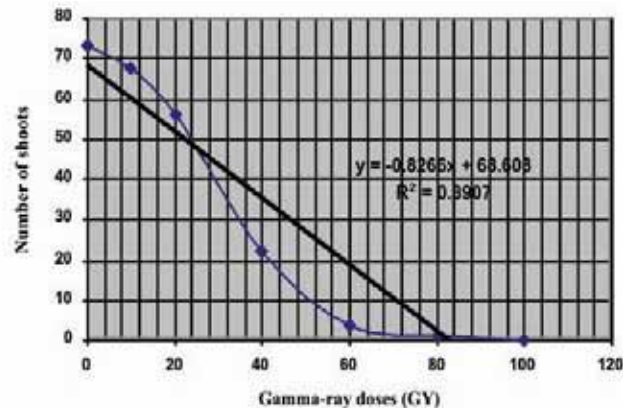

Figure 1 Radiosensitivity test - Percentage shoot formation.

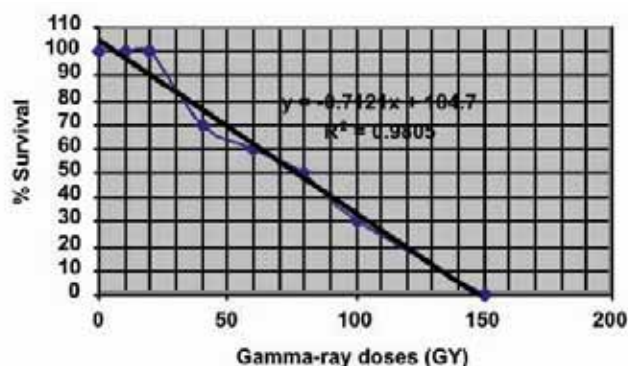

Figure 2 Radiosensitivity test - Percentage of survival.

Adventitious buds began to appear after two months in culture and shoots started to proliferate when meristem explants from suckers were explanted on MS medium with 2.5mg/l BA. Media with higher BA concentration (>3.0mg/l) have provoked high rates of somaclonal variation in pineapple, including plants with multiple crowns when planted in the field. Newly formed *in vitro* shoots were transferred onto liquid MS medium with 2.5mg/l BA and multiplication was routinely carried out every three to four weeks using Temporary Immersion Bioreactor System.

Radio-sensitivity test and *in vitro* mutagenesis

In a mutation breeding experiment, LD₅₀ gives an indication of the response of different types of explants of a species to radiation, so that the right dose(s) for the main field experiment can be selected. When selecting the most effective dose(s) for the main experiment, it is advisable to select a few (more than one) which are 20-30% lower than the LD₅₀ value. Induction of desired mutations by radiation being by chance, it is safer to choose the doses that can cause less damage and give higher multiplication and survival rate.

Radiosensitivity of meristem tissues producing shoots of pineapple was inversely proportional to the irradiation dose. As the dose was increased, mutations appeared more frequently, indicated by the formation of albino and striped leaves. The doses required LD₅₀ and LD₁₀₀ of meristem tissues for shoot formation were 40Gy and 83Gy, respectively (Fig. 1). On the other hand, the doses required for LD₅₀ and LD₁₀₀ for survival rate were 77Gy and 147Gy, respectively (Fig. 2). Suitable effective doses for the main field experiment are suggested in the lower region alongside with LD₅₀ curve where multiple shoots are regenerated from the irradiated meristem tissues. Therefore, for the main field experiment 10, 20, 30 and 40Gy were selected based on shoot multiplication rate. The limit for shoot induction from irradiated explants generally agreed with the LD₁₀₀ curve.

Mass propagation of *in vitro* plantlets using bioreactor system

Mass propagation of irradiated shoots was carried out using Temporary Immersion Bioreactor System in MS liquid media with 2.5mg/l BA, at 23°C with a 16-hour photoperiod. Previous multiplication work done on pineapple using MS solid media with 2.5mg/l BA gave an average of 3.5 new shoots after 30 days in culture. In comparison, MS liquid media with 2.5mg/l BA using Temporary Immersion Bioreactor System produced an average of 15.5 new shoots after 30 days in culture. Shoots were routinely sub-cultured for multiplication using fresh MS liquid medium every 30 days. By the M₁V₃ generation, a total of 20,000 *in vitro* shoots were regenerated from selected doses of 10, 20, 30 and 40Gy.

In vitro roots started to form after two weeks of culture on MS solid media containing 1% activated charcoal and with 2.0mg/l IBA. Plantlets with fully formed *in vitro* roots measuring 10.0 to 12.5 cm in height were transferred to soil-mix in the nursery for acclimatization and hardening for a period of two months.

From a total of 20,000 irradiated plantlets, which were pre-screened in the nursery for desired characters, 60% of the mutant plants had smooth leaves with vigorous growth compared to spiny leaves of control plants. Percentages of mutant plantlets with smooth leaves recorded were 15% for 10Gy, 20% for 32Gy, 30% for 30Gy and 35% for 40Gy. In addition, 10 and 20Gy produced mutant plantlets, which were vigorous in growth compared to higher doses of 30 and 40Gy. This experiment clearly indicates that *in vitro* mutagenesis of meristem tissues of pineapple using low doses of gamma irradiation (10, 20, 30 and 40Gy) was able to produce useful mutant plants with smooth leaves and vigorous growth. Pineapple plants with smooth leaves are very much preferred for large-scale field planting since harvesting of fruits is done manually and this will result in fewer injuries to the workers. In addition, vigorous growth mutants were

also specially selected so as to screen for early fruiting mutants (less than 12 months) in the field.

Field screening in hot spot

After pre-screening in the nursery for a period of two months, a total of 12,000 mutant plantlets with smooth leaves and vigorous growth were selected for field planting. Only rooted plantlets reaching a height of 17.5 to 20 cm were first transferred to the field for screening against bacterial heart rot disease. Previous work done by MARDI has indicated that small rooted plantlets (10.0 to 12.5cm in height) were unable to survive and almost 90% died after one month field planting, while tissue culture derived plantlets of pineapple with specific height of 17.5-20cm have a >95% survival when transferred to the field.

After field planting and screening for bacterial heart rot disease in hot spot for a period of 10-12 months, performance of mutant plants were recorded and compared with the control. Out of 12,000 mutants plants screened in hot spot during the first planting season, a total of 21 potential mutant plants were selected based on desired characters, such as: a) resistance to bacterial heart rot disease, b) single crown, c) cylindrical fruit shape with bigger fruit size and weight (>800g/fruit), and d) higher sugar content (>18 TSS). A total of 2,100 mutant plants were regenerated using suckers from selected 21 mutant lines and screened again in hot spot for a second planting season. After harvesting, 16 potential mutant lines were selected. At doses of 10 and 20Gy, there were no potential resistant mutant plants with a significant improvement in total sugar content and fruit weight. However, at 30 and 40Gy, 11 and five resistant plants with significant increase in both total sugar content (20-25 sugar index compared to control, only 18) and fruit weight (800-900g/fruit compared to control, 500-600g/fruit). Further investigations on molecular analysis using AFLP technique will be conducted to identify markers for the selected characters.

The present method of gamma irradiation in combination with tissue culture, proved to be excellent in increasing efficiencies of useful induced mutation and it is an innovative technology which represents high improvement to the somaclonal variation and conventional breeding of pineapple (Chan, 1993). Potential mutants will be micropropagated and released to the farmers for large-scale planting.

BIBLIOGRAPHY

1. Chan, Y.K., Lam, P.F. Field performance of tissue-cultured 'Josapine' pineapple. *J. Trop. Agric. Fd. Sci.* (in press) (2002).
2. Chan, Y.K. Recent advancements in hybridization and selection of pineapple in Malaysia. *Acta Horticulturae* **334**, 33-44 (1993).

Natural Genetic Variation in Cassava (*Manihot esculenta* Crantz) Landraces: A Tool for Gene Discovery

L J C B Carvalho^{1*}, C R B de Souza², J C de Mattos Cascardo³, M A Valle Agostini¹, E Alano Vieira⁴, J V Anderson⁵ & J Lippolis⁶

Abstract

Cassava landraces are the earliest form of the modern cultivars and represent the first step in cassava domestication. Our forward genetic analysis uses this resource to discover spontaneous mutations in the sucrose/ starch and carotenoid synthesis/accumulation and to develop both an evolutionary and breeding perspective of gene function related to those traits. Biochemical phenotype variants for the synthesis and accumulation of carotenoid, free sugar and starch were identified. Six subtractive cDNA libraries were prepared to construct a high quality (phred > 20) EST database with 1,645 entries. Macroarray and microarray analysis was performed to identify differentially expressed genes aiming to identify candidate genes related to *sugary* phenotype and carotenoid diversity. cDNA sequence for gene coding for specific enzymes in the two pathways was obtained. Gene expression analysis for coding specific enzymes was performed by RNA blot and Real Time PCR analysis. Chromoplast-associated proteins of yellow storage root were fractionated and a peptide sequence database with 906 entries sequences (MASCOT validated) was constructed. For the sucrose/starch, metabolism a *sugary* class of cassava was identified, carrying a mutation in the BEI and GBSS genes. For the pigmented cassava, a pink color phenotype showed absence of expression of the gene CasLYB, while an intense yellow phenotype showed a down regulation of the gene CasHYb. Heat shock proteins were identified as the major proteins associated with carotenoid. Genetic diversity for the GBSS gene in the natural population identified 22 haplotypes and a large nucleotide diversity in four subsets of population. Single segregating population derived from F₂, half-sibling and S₁ population showed segregation for *sugary* phenotype (93% of individuals), waxy phenotype (38% of individuals) and glycogen like starch (2% of individuals). Here we summarize our current results for the genetic analysis of these variants and recent progress in mapping of loci and with large-effect genes.

Introduction

Biochemical phenotypes are essential for the definition of gene functions and to understanding gene regulation. Currently, such functional analysis uses either forward or backward genetic approaches with laboratory-induced mutants. Studies on genetics of cassava are rare, incomplete and most of the time difficult, because of long life cycle of the plant. Mutants have not been found in cassava. Some reports have attempted to identify phenotype variants in landraces for starch type without genetic analysis [1], laboratory-induced mutants in starch [2], and linamarin cleavage [3] in a restricted number of genetic backgrounds. In cassava, an alternative to laboratory-induced mutants is identifying biochemical phenotypes in landraces in their center of origin and domestication. Since cassava

is not a selfing species, most of the collected plants are highly heterozygous, making it practically impossible to find in nature an inbred line that could carry a recessive character like a mutation in phenotype using conventional genetic analysis. Therefore, exploitation of such genetic variation for either quantitative or qualitative traits needs molecular species-specific tools for genetic analysis. In considering the constraints of producing offspring and the complexity of the cassava genome, our two complementary strategies are based on association genetics analysis using natural populations and single segregating population, the latter involving more time and field experiments.

For association studies, we accessed the center of origin and domestication of cassava [4] to explore the possibility of isolating useful natural mutants. Our search was focused on starch and carotene accumulation because relatively few major genes are involved. Because resources were often limited, our study was performed in a two-stage approach by using a subset of samples to identify biochemical phenotypes and SNPs. Instead of genotyping hundreds of controls for the characterization of haplotype tag SNPs (htSNPs), we genotyped sample cases and carried out preliminary tests of association to aid the selection of htSNPs. Once the subset has been genotyped, the whole set of loci will be tested for equilibrium to proceed. In addition, cross populations are being prepared, based on a modified backcross breeding design, to obtain single segregating populations with alternate new local adapted parental divergent from the antecessor parental identified by marker assisted recurrent selection (MARS). Here, we summarize our advances on this systematic exploitation of the naturally occurring variation as a complementary resource for the functional analysis of the cassava genome.

Biochemical phenotype characterization

The use of the candidate gene approach requires considerable knowledge of the physiology and biochemistry of the phenotype. This knowledge is available for starch and carotenoid accumulation in model plants as well as grain crops and has been applied successfully in carotenoid candidate gene analysis in *Solanaceae* [5]. However, the biology of biochemical phenotypes is usually species-specific and varies with the organ and storage tissue studied. Consequently, different mechanisms of regulating starch and carotenoid accumulation are involved, including genetic background of the cultivar, as well as the general environment.

Sugary cassava: Normal cassava storage root accumulates a large amount of starch with distinct features such as clarity of the gel, excellent thickening (swelling capacity), neutral flavor and good-texture quality. All these properties are largely determined by the starch type and composition (amylose/amylopectin proportion). Some variation in amylose proportion has been observed, but the lack of variation in amylopectin structure is remarkable. A new class of cassava (named *sugary*) was reported [1], with high free sugar content, several variants in the starch type and composition, including amylose-free starch, glycogen-like starch, and a unique amylopectin structure when compared with normal cassava (Fig. 1A). Landrace CAS36.1 showed the highest glucose content (248.2 mg g⁻¹ DWt) and a glycogen-like starch [1]. The

¹ Embrapa-Genetic Resources and Biotechnology, Brasília-DF, Brazil.

² Universidade Federal do Para, Belém-PA, Brazil.

³ Universidade Estadual de Santa Cruz, Ilhéus-BA, Brazil.

⁴ Embrapa Cerrados Brasília-DF, Brazil

⁵ USDA-ARS, Plant Science Research Unit, Fargo-ND

⁶ USDA-ARS National Animal Disease Center, Ames-IA

* Corresponding author. E-mail: carvalho@cenargen.embrapa.br

sugar profile separated in a GC-MS analysis revealed free sugars such as arabinose, glucuronic acid, galacturonic acid, manose and xylose that were not observed in the profile for normal cassava (Fig. 1B). Enzyme activities and protein blot analyses revealed that the branching enzyme I (BEI), and its corresponding protein, is either low or not detected in landrace Cas36.1 [1]. Therefore, the *sugary* cassava phenotype revealed biochemical variants related to free sugar content and composition that could involve starch synthesis/degradation, as well as cell wall degradation and modification in amylopectin structure associated to the missing activity of BEI [1].

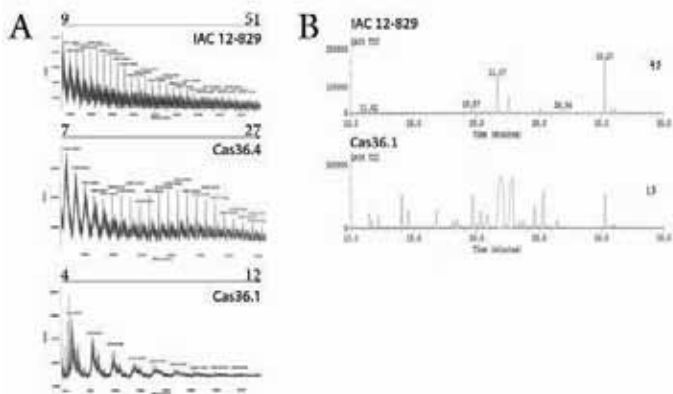

Figure 1 Sugar composition and amylopectin structure variation in cassava. (A) Amylopectin structure as revealed by digestion of amylopectin with β -glucosidase and polyglucan fragment identified by mass spectrometer analysis (MALDI-TOF apparatus). Polyglucan fragments varied from 9-51, 7-27 and 4-12 units of glucose for cv. IAC 12-829 and landraces Cas36.4 and Cas36.1, respectively. (B) Free sugar profile revealed by GC-MS analysis.

Pigmented cassava variants: Naturally occurring color variation associated with carotenoid accumulation was observed in cassava storage root. Carotenoid separation, identification and quantification by HPLC analyses indicate that total β -carotene is the major carotenoid form present and accounts for 54% to 77% of the total carotenoid in cassava storage roots. The carotenoid biosynthetic pathway is fully activated in cassava storage root, including the white phenotype. No detection of α -carotene in 24 landraces studied was observed, but variable amounts of lutein (an β -ring xanthophyll) were present. Yellow color intensity variation was associated with the accumulation of different carotenoids. Landraces with white storage root showed a profile with eight types, whereas intense yellow showed 17 types. Variation in total β -carotene content ranged from none in landrace Mirasol (pink) that accumulates only lycopene (99.81 $\mu\text{g g}^{-1}$ DWt), to 49.91 ($\mu\text{g g}^{-1}$ DWt) in landrace MC008 (deep yellow) that accumulates β -carotene (66%) its colorless precursor phytoene (31%) and its derived intermediate β -criptoxanthin (3%). Variations, in α and β -ring xanthophyll content, preferentially accumulate high amounts of lutein or violaxanthin, together with β -carotene, such as in landraces MC002 and MC016, respectively. The possible mechanisms responsible for this genetic variation include genetic regulation by genes coding for enzymes in the syntheses pathway as observed with the pink landraces, variants in the yellow that differentially synthesize β -carotene and β -ring xanthophylls (violaxanthin, neoxanthin, luteoxanthin and auroxanthin) but not α -ring xanthophylls (lutein) and carotenoid cleavage enzymes. In addition, the differential accumulation of β -carotene could possibly be associated with the sink capacity of chromoplasts related to carotenoid sequestering proteins as shown below.

Chromoplast-associated proteins analysis: Carotenoid accumulation is likely to be regulated by the carotenoid sequestering proteins in chromoplasts and may have a three-fold importance to cassava: firstly, to explain the range of β -carotene content in the yellow color gradient, secondly, to better understand the carotenoid protein sequestering mecha-

nism in non-photosynthetic tissue and, thirdly, to account for protein content enhancement in cassava storage root due to the need for more functional proteins in the root tissue. In exploring this alternative, we first observed that protein content was 40-60% higher in intense yellow than in white cassava [6]. Correlation studies between total carotenoid and protein content indicated that the level of significant correlation is dependent on the method and procedure used to estimate protein and that protein is linearly correlated with β -carotene (Fig. 2). To dissect this correlation, a procedure combining chromoplast-enriched suspension, fractionation of carotenoid-protein complex in size exclusion chromatography (SEC) and protein blot analysis was developed. **Figure 3A and 3B** show two protein peaks separation in the SEC profile for white and yellow root. The carotenoid-protein complexes in peak 1 revealed β -carotene (Fig. 3C) as the major pigment present in yellow and traces of it in white landraces. 2DE gel [6] and SDS-PAGE analysis of fractions of peak 1 and peak 2 showed a large protein number difference between yellow and white color phenotypes (data not shown). To identify which proteins are specifically associated with β -carotene present in peak 1, the protein complex in each peak was sequenced.

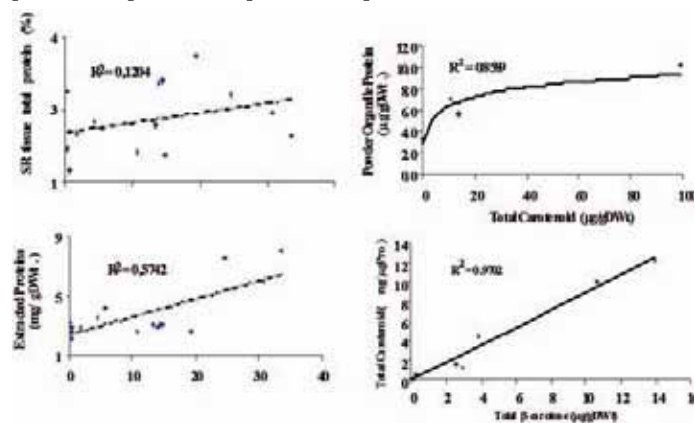

Figure 2 Correlation between total carotenoid and protein content. (A) crude protein (%; factor 3.24). (B) saline buffer soluble protein (mg/gDW, Bradford). (C) Enriched chromoplast suspension proteins quantified (Bradford). (D) Total carotenoid expressed on protein base. Total carotenoid was extracted and quantified by spectrometry. β -carotene was separated by HPLC and amount estimated by peak integration.

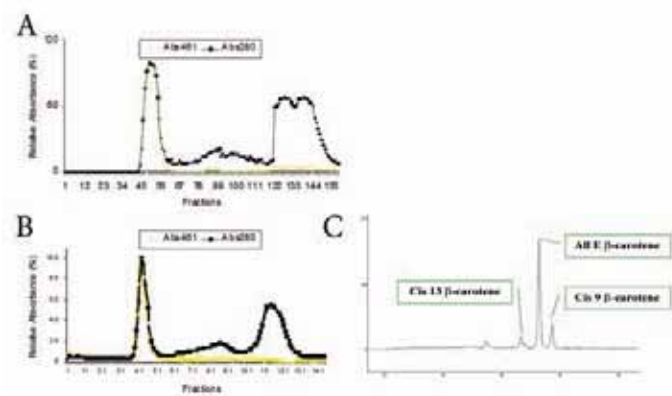

Figure 3 Protein-carotenoid complex characterization. Size exclusion chromatography separation of carotenoid-protein complex (Peak 1) and non-associated protein (Peak 2) in yellow (A) and white (B). (C) HPLC carotenoid profile present in Peak 1 identifying β -carotene.

Molecular isolation and characterization of candidate genes responsible for naturally occurring variation

To find candidate genes of interest, global (macroarray and microarray) and specific gene expression analysis was performed. Six subtractive

cDNA were constructed and an EST database was assembled for *sugary* and pigmented cassava. Clones of cDNA fragments for genes coding for enzymes related to starch and carotenoid synthesis were sequenced. Chromoplast-associated proteins sequences and their corresponding genes were identified using three EST cassava databases (<http://genoma.embrapa.br/genoma/>, http://titan.biotech.uic.edu/cgi-bin/ESTWebsite/estima_start?seqSet=cassava, <http://www.brc.riken.go.jp/lab/epd/Eng/catalog/pDNA.shtml>) to identify differentially expressed proteins and genes.

Differentially expressed gene in *sugary* cassava: Global differentially expressed genes between normal and *sugary* cassava were accessed with a membrane base cDNA chip built up with 264 genes and hybridized with cDNA obtained by reverse transcription of total RNA population. Results indicated that the major genes differentially expressed are largely related to stress response such as up-regulated gene for ABA synthesis (two genes), transcription factor homolog related to hypoxia (2 genes), transport proteins for glucose/ABA (one gene), nitrogen (one gene), and three unknown genes. Due to the low resolution of this technique, seven cDNA clones for gene coding for enzymes related to starch synthesis were cloned, sequenced and used for mRNA blot analysis. Results showed that the expression of the gene coding for BEI is missing in the *sugary* phenotype with glycogen-like starch [1]. For the waxy starch type, the analysis of cDNA and genomic DNA sequence of the GBSSI gene for normal and *sugary* cassava carrying waxy starch type showed a nonsense mutation on the N-terminal in the coordinates 337-372 of the mRNA (data not shown).

Differentially expressed genes in pigmented cassava: Global differentially expressed genes (microarray) between normal and pigmented cassava were accessed with a cDNA chip built up with 24,000 Euphorbiaceae genes and hybridized with cDNA obtained by reverse transcription of total RNA population. Preliminary results indicated that three carotenoid cleavage enzyme coding genes were upregulated in relation to pigmented cassava (not shown). Sequences of cloned cDNA fragments for the genes coding phytoene synthase (CasPSY), phytoene desaturase (CasPDS), carotenoid isomerase (CasCRTISO), lycopene β -cyclase (CasLCYb), β -ring hydroxylase (CasHYb), and neoxanthin synthase (CasNXS) were obtained. Transcript profiles for those genes across landraces contrasting carotenoid HPLC profiles consistently correlated with end products of carotenoid synthesis. Transcript levels for CasPSY were equivalent in all landraces evaluated, while trace values of CasLCYb and CasHYb were observed in landraces that accumulate only lycopene (Mirasol) or β -carotene (MC008), respectively. Taken together, these results indicated two kinds of color mutations related to carotenoid synthesis: the pink color genotype, which accumulates only lycopene with traces expression value detected for the gene CasLCYb, and the intense yellow genotype (MC008), which accumulates mainly β -carotene, indicating a down regulation of the gene coding for CasHYb.

Identification of carotenoid-associated proteins: From the SEC results above, proteins recovered from Peak 1 were sequenced by a classic PROTEOMIC procedure. The majority of the pigment-associated proteins in Peak 1 belong to the small heat shock proteins (sHSP) family class I and II. This provides evidence to support roles of sHSPs on the specificity of β -carotene accumulation in cassava, as observed for chaperonin21 for lycopene in tomato [7, 8]. The mechanism by which sHSPs promotes carotenoid accumulation is yet unknown. To gain knowledge on the sHSPs effects on β -carotene differential accumulation in yellow root phenotype, cDNA sequence for the gene coding for all the sHSPs identified in the carotenoid-protein complex were obtained and tested with Real time PCR. The results confirmed the protein blot experiment for fibrillin protein (not shown) and indicated traces of HSP18.1 protein in white cassava and a 7.2-fold higher expression value for the intense yellow phenotype. Together, these results indicate a possible gene mutation related to the carotenoid protein-sequestering mechanism in white

cassava. Genes coding for sHSPs are not single copy but are distributed in six different classes, hence making it difficult to be used as a candidate gene in the genetic analysis.

Forward genetic studies of naturally occurring variation

Our forward genetic analysis is focused on two alternative experimental designs. In the first one, a population genetic analysis is carried out with candidate genes derived from the biochemical phenotypes as described above and tested under an evolutionary perspective in a subset sample of a population including cassava ancestors (33 individuals), and landraces (121 individuals). The analytical procedure follows the rational and computer soft as (9,10). In the second, crossing populations based on a modified backcross breeding design to obtain single segregating populations for mapping, field evaluation and new cultivars are being prepared.

Genetic analysis of natural populations: Two candidate genes coding for starch synthesis (CasBEI and CasGBSSI) and three for carotenoid synthesis (CasPSY, CasLCYb and CasHYb) were selected and are sequenced across a population of 154 individuals. Here we show our preliminary analyses in a subset sample for the N-terminal region of the CasGBSSI. Table 1 summarizes the statistics describing the sequence diversity in the combined and each subset of the four classes of population. Larger nucleotide diversity is observed in the cassava ancestor followed by the pigmented cassava. Tagima's D value was highly significant for the combined subset sample indicating genetic neutrality. Haplotype number and diversity was also high for combined and ancestor subset.

Table 1. Genetic diversity estimates and neutrality test for GBSS (N-Terminal).

Phenotype	Sample	Nucleotide Diversity (π)	Theta (θ)	Tagima's D	Haplotype number	Haplotype diversity
Ancestor	4	0,02044 (0,00689)	0,02187 (0,00157)	-0,66711 (NS)	22	0,966 (0,00031)
Normal	14	0,00978 (0,00021)	0,01659 (0,00688)	-1,73316 (NS)	12	0,978 (0,00119)
<i>Sugary</i>	8	0,00749 (0,00165)	0,00889 (0,00458)	-0,77880 (NS)	6	0,929 (0,084)
Pigmented	6	0,01992 (0,00619)	0,02416 (0,01212)	-1,10378 (NS)	5	0,933 (0,01481)
Combined	32	0,01232 (0,00245)	0,03068 (0,01006)	-2,29800 **	22	0,966 (0,018)

Values in parenthesis are standard deviation.
(NS) is not statistically significant.
** is statistically significant at $P < 0.0001$.

The likely genealogical history of the genetic diversity showed in **Table 1** was inferred from RM networks constructed for haplotypes in the combined (**Fig. 4A**) and separate population samples (**Fig. 4B-E**).

Genetic analysis in single segregating populations: Field-tests for agronomic performance and morphological descriptors have been performed in the Cerrado region of Brazil since 2002 in a provenance test. Results showed identical *sugary* and pigmented phenotypes as observed early in the center of origin and domestication. In 2006, a breeding programme was initiated to transfer these new identified traits to local varieties. In addition, RAPD and SSR markers were also applied and showed a large genetic diversity among the *sugary* accessions. Agronomic performance indicated that the landrace Cas36.17 (waxy starch type) yielded about 9 ton/ha (12 month growth season base) while the best-adapted local variety (cv. Japonésinha) yielded 28 ton/ha. All the other *sugary* accessions showed mainly lower yield due to a severe attack of *Xanthomonas axonopodis* pv. *manihotis*. This information was used to better orientate the selection of landraces within individuals obtained in the crossed populations (F_1 segregating and self pollination population). Preliminary results for a half sibling population (55 individuals) tested in the 2006/2007 growth season revealed segregation of *sugary* phenotype

(93% of the individuals), waxy phenotype (38% of the individuals) and glycogen-like starch (2% of the individuals). Individuals (185) of the S_1 population for the best-adapted *sugary* landrace were planted in the 2007/2008 growth season in the Cerrado region and are being evaluated as above.

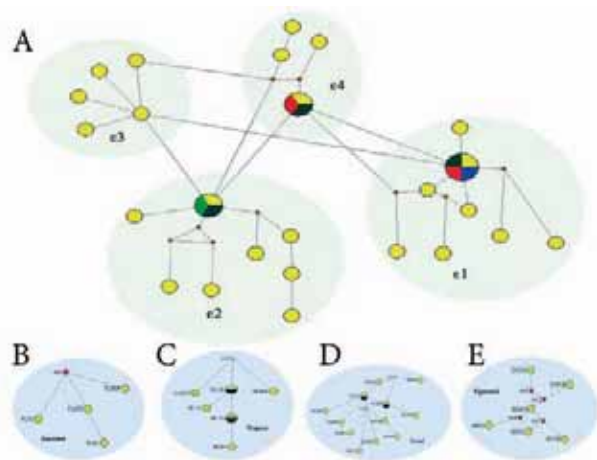

Figure 4 RM network of GBSS sequence haplotype. **(A)** Combined samples and sample subset for Cassava Ancestor **(B)**, *sugary* cassava **(C)**, normal cassava **(D)** and pigmented cassava **(E)**.

Concluding remarks and prospects

Cumulatively, our results confirm the importance of landraces, the efficiency of developing species-specific molecular tools directly from the naturally occurring variations and point out new research for cassava, related to protein enhancement in the storage root.

The exploitation of these variants will increase and become more systematic and efficient with the development of more permanent mapping populations, high-throughput genotyping technologies, improved QTL mapping statistical methods and more precise assays for phenotype analysis.

ACKNOWLEDGEMENTS

For financial support, we would like to thank Conselho Nacional de Desenvolvimento Científica e Tecnológico – CNPq (Grant # 480410.2001-1); Programme Nacional de Pesquisa em Biotecnologia – CENARGEN (Project N° 060302058) and IAEA (contract # 13188.). The germplasm derived from this study was donated to Harvest-Plus Initiative and deposited in CIAT germplasm collection.

BIBLIOGRAPHY

1. Carvalho, L.J.C.B., Souza, C.R.B., Cascardo, J.M.C., Junior, C.B., Campos, L. Identification and characterization of a novel cassava (*Manihot esculenta* Crantz) clone with high free sugar content and novel starch. *Plant Molecular Biology* **56**, 634-659 (2004).
2. Raemkers, K., Schreuder, M., Suurs, L., Furrer-Verhorst, H., Vincken, J.P., Vetten, N., Jacobsen, E., Visser, R. Improved Cassava Starch by Antisense Inhibition of Granule-bound Starch Synthase I. *Molecular Breeding* **16**, 163-172 (2005).
3. Siritunga, D., Sayre, R.T. Engineering cyanogen synthesis and turnover in cassava (*Manihot esculenta*). *Plant Molecular Biology* **56**, 661-669 (2004).
4. Schaal, B.A., Olsen, K.M., Carvalho, L.C.B.J. In: Darwin's Harvest: New Approaches to the Origins, Evolution, and Conservation of Crops edited by Timothy J. Motley, Nyree Zerega, and Hugh Cross. Columbia University Press, New York, NY, p.390 (2005).
5. Thorup, T.A., Tanyolac, B., Livingstone, K.D., Popovsky, S., Paran, I., Jahn, M. Candidate gene analysis of organ pigmentation loci in the Solanaceae. *PNAS* **97**, 11192-11197 (2000).
6. Carvalho, L.J.C.B., Agostini, M.A.V., Junior, C.B. Sixth International Scientific Meeting of Cassava Biotechnology Network. Cali, Colombia (2004).
7. Neta-Sharir, I., Isaacson, T., Lurie, S., Weiss, D. Dual Role for Tomato Heat Shock Protein 21: Protecting Photosystem II from Oxidative Stress and Promoting Color Changes during Fruit Maturation. *Plant Cell* **17**, 1829-1838 (2005).
8. Sabehat, A., Weiss, D., Lurie, S. The Correlation between Heat-Shock Protein Accumulation and Persistence and Chilling Tolerance in Tomato Fruit. *Plant Physiol.* **110**, 531-537 (1996).
9. Templeton, A.R., Maxwell, T., Posada, D., Stengard, J.H., Boerinkle, E., Sing, C.F. Tree scanning: a method for using haplotype trees in phenotype/genotype association studies. *Genetics* **169**, 441-453 (2005).
10. Posada, D., Maxwell, T.J., Templeton, A.R. TreeScan: a bioinformatic application to search for genotype/phenotype associations using haplotype trees. *Bioinformatics Applications Note* **21**, 2130-2132 (2005).

Induced Mutations in Coleus (*Solenostemon rotundifolius*) (Poir. J.K. Mortan) – An Under-Utilized Medicinal Tuber

M Abraham* & V V Radhakrishnan

Abstract

Sixty Coleus accessions collected from different eco-geographical regions of Kerala and neighboring states exhibited genetic diversity. High heritability was observed for tuber yield, harvest index, biological yield per plant, tuber volume and tuber weight. The 60 accessions were grouped into 10 clusters and there was no parallelism between genetic diversity and geographical distribution. Representative genotypes from the 10 clusters were subjected to mutagenic treatment using Gamma-rays and EMS. The response of Coleus to mutagen varied with concentration as well as with genotype. Mutation has changed the plant height, size of tubers and tubers per plant. In addition, selected mutants showed photoin sensitivity to tuberization and acceptable qualitative changes. Based on their field performance, mutants M 131 and M 61 were identified for year round cultivation.

Introduction

Solenostemon rotundifolius (syn. *Coleus parviflorus*), commonly known as Chinese potato, is a native of Africa and possesses elite flavor, taste and unique medicinal properties due to the presence of flavanoids which help to lower cholesterol level in blood [1]. The crop has high consumer preference and is extensively grown in southern peninsular India, but year-round cultivation is not possible as it is photosensitive. Furthermore, the yield is also low. As it is vegetatively propagated, seed set is absent and there is no appreciable variability in the germplasm for genetic improvement. Hence, an attempt was made to explore and assess the genetic variability present in the major growing areas and to supplement it through mutation for further exploitation in breeding of the crop.

Materials and Methods

An eco-geographical survey of the cultivation of Coleus was conducted in three southern states of India viz., Kerala, Karnataka and Tamil Nadu. Samples of Coleus cultivars along with its wild progenitors were collected from farmers' fields and main markets of the area. Sixty accessions thus collected, formed the basis of the study. The seed tubers collected from various sources were multiplied in primary nurseries and 45-day-old cuttings were planted in the main field at the College of Horticulture, Vellanikkare from June to November 1999. The first experiment was laid out in randomized block design with two replications. Each plot consisted of 10 plants in two rows 60 cm apart, with 30 cm between each plant. The data of 13 important quantitative characters were recorded from five randomly selected plants and subjected to statistical analysis, namely tuber yield, tuber girth, point of tuber formation (base of stem / leaf node / base of stem and leaf node), volume of tuber, weight per tuber, tuber density, tubers per plant, days to tuberization, nematode susceptibility, days to flowering, plant height, biological yield and harvest index.

The variability in present population was partitioned into heritable and non-heritable components with the aid of genetic parameters like genotypic coefficient of variation (gcv), heritability (h^2), and genetic advance (ga), (Table 1).

Cluster analysis was carried out following the methods compiled by Singh and Chaudhary [2]. The 60 accessions were grouped into 10 clusters based on the economic traits. Based on the ranking, the overall best tuber yielder from each cluster was selected and subjected to physical and chemical mutagenic treatment with EMS as the chemical mutagen, and Gamma-rays as the physical mutagen.

Table 1. Estimates of genetic parameters for thirteen characters in Coleus

Character	P.C.V	G.C.V	h ² (%)	G.A	G.G
Tuber yield (g)	49.97	41.89	70.70	162.56	72.34
Tuber girth (mm)	18.18	10.35	33.16	5.96	12.14
Point of tuberization	22.72	9.34	17.74	0.18	7.89
Volume per tuber (cc)	42.71	37.90	79.08	4.13	69.30
Weight per tuber (g)	42.63	38.27	80.89	4.56	70.81
Tuber density (g/cc)	7.53	5.70	57.92	0.09	8.49
Tubers per plant	39.69	22.09	31.72	13.75	25.32
Days to tuberization	5.24	1.46	8.64	1.07	0.85
Nematode susceptibility	48.54	22.68	22.63	0.52	21.94
Days to flowering	52.94	1.33	0.01	0.0004	0.16
Plant height (cm)	23.13	19.89	74.28	34.70	35.21
Biological yield	48.80	42.98	77.92	520.84	77.99
Harvest index	51.81	45.15	76.31	0.22	81.09

The seed tubers from selected genotypes were grown in the primary nursery and 45-day-old single node cuttings were taken for mutagenic treatment using physical and chemical mutagen. Estimation of LD₅₀ was done for both Gamma-rays and EMS. Twenty different doses of Gamma-rays ranging from 1Gy to 100Gy were used under laboratory conditions, and survival was recorded based on the percentage of variation of sprouting of cuttings over the control. Based on this, LD₅₀ for Gamma-rays was found to be 40Gy. Hence, selected doses for gamma irradiation were 10, 20, 30, 40, & 50Gy.

For the estimation of LD₅₀ for EMS aqueous solutions of 0.05, 0.10, 0.15, 0.20, 0.30, 0.40, 0.50, 1.00, 1.50, 2.00 and 2.50 % were prepared, and 10 cuttings were immersed in different solutions for 30 minutes. The treatment duration was selected based on results from a preliminary study involving four durations viz., 15, 30, 60 and 90 minutes. The LD₅₀ value was fixed at 0.4 %. Based on this, selected doses of EMS were 0.2, 0.4, 0.6, 0.8 and 1.0 %. The treated cuttings were raised in 10 x 3 factorial RBD with two replications. Spacing and after care were given as per Package of Practice recommendations [3]. Data of 13 economic traits was taken from individual plants and subjected to statistical analysis in

Department of Plant Breeding and Genetics, College of Agriculture, Vellayani, Trivandrum, Kerala, India

* Corresponding author. E-mail: mareen1961@yahoo.co.in

which genotypes were taken as main effects and doses as sub effects. The effect of the mutagen was evaluated on the basis of the percentage of sprouting of single node cuttings and establishment of the mutant under field conditions. Superior genotypes were identified based on yield and yield-contributing characters and advanced to further generations to study their yield and photo insensitivity. Fourteen superior mutants thus isolated from mutagenic treatments were tested for photo insensitivity in three seasons viz., December 1999, February 2000 and April 2000. Observations were subjected to statistical analysis. Analysis of variance for different factors and its interactions were worked out as per [2] (Table 2).

Results and Discussion

Genetic variability

Sixty *Coleus* genotypes from different ecogeographical regions of Kerala and neighboring states were collected. The highest number of genotypes was collected from Thrissur district followed by Malappuram, since these two districts form the major *Coleus* growing tracts in Kerala, India. During the course of collection, wild progenitors were not seen in the areas of cultivation, which indicated that this is an introduced crop. Analysis of variance showed significant differences among genotypes for the 13 characters, suggesting the existence of genetic diversity among the *Coleus* genotypes. Variability for different characters was previously reported already [4, 5].

A high magnitude of *gcv* and *pcv* followed by h^2 and genetic advance were observed for tuber yield, harvest index, biological yield/plant, volume/tuber yield, harvest index, biological yield/plant, volume/tuber and weight/tuber. This indicates the heritable nature of these characters with negligible influence of environment. Tuber density showed low values for *ga* (0.09), *pcv* (7.53), *gcv* (5.70) and high values for h^2 (57.92), indicating an additive gene action. The same held true for point of tuber formation. Mean girth of tuber showed low values for h^2 (33.16), *pcv* (18.18), *gcv* (10.35) and genetic advance (5.96), stressing the higher influence of environment on this trait. Similar results were also observed in sweet potato [6]. Correlation and path analysis studies conducted in this investigation revealed that for tuber yield improvement in *coleus*, the breeder should give emphasis on high harvest index with optimum plant height and a larger number of tubers with medium size and high density. Such plant types should also be shorter in duration and coupled with high nematode resistance.

Genetic diversity

D^2 analysis employing a combined classificatory approach in respect of 13 selected characters recorded that the 60 accessions could be grouped into 10 clusters. This grouping indicated that some genotypes belonging to the same location grouped into different clusters, while certain genotypes habitating in different locations grouped in the same cluster. The results indicated that factors other than geographical diversity may be responsible for such clustering and that there was no parallelism between geographical distribution and genetic diversity, as also observed in rice [7] and in *Colocasia* [8]. Genotypes in a cluster with a high order of divergence among themselves would be the best breeding material for achieving maximum genetic advance with regard to yield.

Mutagenesis

Coleus mutants exhibited variation in yield attributes and photoinsensitivity with varying doses of Gamma-rays and EMS. The effect of the mutagen on *Coleus* was assessed in terms of mutant survival.

The sprouting percentage at 30 days after planting was found to decrease with increase in the concentration of mutagens, as previously reported in Canna [9] and in Ginger [10]. Delay in sprouting was another observed effect with increased concentrations of mutagen. The response of *Coleus* to mutagens varied with concentrations as well as with genotypes, which may be due to differences in the genetic architecture of the plant, which responded differentially to the mutagen. Similar mutagenic concentration and genotype relationships were reported in Kacholam [11]. Gamma-rays and EMS-induced positive variation in the number of tubers per plant. EMS created significant influence altering the density of tubers of various genotypes. Plant height, which had a significant negative correlation with yield in the parental population reversed to a positive correlation in mutants due to the mutation.

The field performance of selected mutants and parents for growth and yield traits during April 2001 to October 2001 (Table 3) indicated that the effect of mutation was related to concentration of mutagen and genotype. EMS at 1 % was effective in inducing variability in tuber yield. Chemical mutagens changed the size and number of tubers and plant height, both positively and negatively in *Coleus*.

Another important positive feature due to mutation was that some of the mutants showed photoinsensitivity for tuberization.

All the mutants differed significantly in many of the characteristics like tuber yield, tuber girth and harvest index for season as well as for its interactions. M 131 ranked first for all seasons for tuber yield taken

Table 2. Characteristics of *coleus* mutants in different seasons

Mutant	Season			Season			Season					
	I Feb 99-May 00	II Feb-May 00	III Apr 99-Oct00	I Feb 99-May 00	II Feb-May 00	III Apr 99-Oct00	I Feb 99-May 00	II Feb-May 00	III Apr 99-Oct00			
No	No. of tubers/plant			Mean	Tuber yield (g/plant)			Mean	Girth of tubers			Mean
131	12.0	29.7	27.3	23.0	103.3	13.3	275.0	130.6	5.3	5.8	5.8	5.6
61	25.7	6.3	22.7	18.2	175.0	38.3	153.3	122.2	5.0	5.6	7.4	6.0
112	5.67	40.7	7.7	18.0	14.0	30.0	30.0	24.7	4.5	4.4	4.2	4.3
641	4.67	11.7	11.7	9.3	26.7	258.3	13.3	99.4	6.4	4.7	5.7	5.6
422	4.3	21.3	17.7	14.3	15.7	228.3	140.0	128.0	4.4	6.7	6.7	6.0
111	7.0	10.3	10.3	9.2	43.3	103.3	121.7	89.4	6.2	5.5	5.7	5.6
121	5.3	5.7	32.0	14.3	34.3	173.3	134.0	113.9	4.1	4.7	5.3	4.7
62	8.3	10.3	31.0	16.6	22.0	170.0	106.7	99.6	3.6	5.7	7.7	5.6
Check	5.3	5.8	4.0	5.0	41.7	52.3	38.5	44.2	6.2	4.8	5.3	5.4
Mean	9.1	17.0	20.0		54.3	126.9	121.8		5.0	5.7	6.0	
CD (Mutants)	2.6				27.0				0.4			
CD (seasons)	4.2				44.1				0.6			

together (130.556 g/plant). In the off-season it was M 61 which recorded maximum tuber yield (175 g/plant). When comparing first and third season, M 61 ranked first in season one (off season 175 g/plant) second in third season (normal season 153.333 g/plant), with a mean of (122.222 g/plant), when all three seasons were taken together. The same trend was also shown for the harvest index and tuber girth. This result indicated that Mutant 131 and Mutant 61 are suitable for year-round cultivation for higher numbers of tubers, tuber yield per plant and size of tubers (Table 2).

Table 3. Growth and yield characteristics of 14 mutants and parents

Mutants and Parents	Plant height (cm)	Biological yield (g)	Tuber number	Tuber yield (g)	Tuber girth (cm)	Harvest index	Tuber density (g/cc)
111	78.33	843.33	10.33	121.67	5.17	0.13	0.58
112	94.67	850.00	7.67	30.00	4.20	0.04	1.24
121	86.67	640.00	32.00	134.00	5.33	0.18	1.19
131	85.33	836.67	27.33	275.00	5.80	0.32	0.72
352	82.00	773.33	10.67	310.00	4.40	0.32	1.57
412	66.33	796.67	7.67	116.67	4.30	0.13	0.37
421	64.67	321.67	15.33	90.00	5.67	0.22	1.20
422	70.33	1016.67	17.33	140.00	6.87	0.12	1.53
632	62.67	923.33	24.00	220.00	4.47	0.21	0.73
641	79.33	843.33	11.67	13.33	5.70	0.02	1.00
1012	75.67	426.67	19.67	128.33	5.67	0.30	1.79
1042	80.33	570.00	12.67	59.00	5.87	0.11	1.04
61a	77.00	730.00	22.67	155.33	7.40	0.16	2.87
61b	78.00	420.00	31.00	106.67	5.57	0.21	0.39
Parlikad local	89.00	1076.67	6.67	36.67	4.00	0.04	0.45
IC – 65724	63.00	1023.33	5.00	46.67	4.53	0.05	0.70
Kolazhy local	68.00	650.00	6.00	20.00	5.60	0.03	0.64
Paipra local	55.00	790.00	5.33	41.67	6.20	0.05	0.40
Mullurkkara III	64.33	450.00	7.00	34.33	6.53	0.07	1.00
SE	± 2.14	± 44.08	± 1.37	± 12.95	± 0.20	± 0.02	± 0.10
CD	4.45	91.69	2.85	26.94	0.42	0.04	0.21

BIBLIOGRAPHY

- Sandhya. Effect of flavanoids on lipid metabolism. Ph.D Thesis, University of Kerala, Thiruvananthapuram, p.160 (1996).
- Singh, R.K., Chaudhary, B.D. Biometrical Methods in Quantitative Genetic Analysis. Kalyani Publishers, Ludhiana, p.318 (1985).
- Kau. Package of Practices Recommendations 'Crops' Kerala Agricultural University, Trichur, p.173 (1993).
- Amalraj, V.A., Velayudhan, K.C., Muralidharan, V.K. Teratological variation in Coleus parviflorus. *J. Root Crops* **15**, 61- 62 (1989).
- Sreekumari, M.T., Abraham, K. Variation and correlation studies in Chinese potato (*Coleus parviflorus* Benth.). *J. Root Crops* **11**, 77-81 (1985).
- Vimala, B., Lakshmi, K.R. Heritability estimates in sweet potato (*Ipomoea batatas* L.). *J. Root Crops* **17**, 63-66 (1991).
- Roy, A., Panwar, D.V. Genetic divergence in rice. *Oryza* **30**, 197-201 (1993).
- Mannan, M.A., Saleh, A.M., Reshid, M.M., Bhuiyan, M.K.R., Gomes, R. Genetic diversity of *Coleus esculenta* (L.) Schott. in Bangladesh. *J. Root Crops* **19**, 95-99 (1993).
- Mukherjee, T., Khosoo, T.N.V. Genetic and evolutionary studies in starch yielding *Canna edulis*. *Gen. Iber.* **23**, 35-42 (1971).
- Giridharan, M.P. Effect of gamma irradiation in ginger (*Zingiber officinale* Rose.). M.Sc (Ag.) Thesis, Kerala Agricultural University, Trichur, p.126 (1984).
- Kanakamony, M.T. Induction of genetic variability in Kacholam (*Kaempferia galanga* L.). M.Sc (Ag.) Thesis, Kerala Agricultural University, Trichur, p.176 (1997).

Resistance of Mutants of Sweet Orange Induced by Gamma-rays to Citrus Canker (*Xanthomonas citri* subsp. *citri*) Under Artificial Inoculation

J Belasque Júnior¹, R R Latado^{2,*} & A Tulmann Neto³

Abstract

The sweet orange holds great economic and social importance for Brazil, but it is susceptible to citrus canker as is the majority of citrus species. In cases of high incidence, this disease caused by the bacterium *Xanthomonas citri* subsp. *citri* can result in great economic damage. More resistant cultivars are the best long-term solution for management of citrus canker and one of the approaches can be the production of mutant plants. In a previous work, several induced mutant clones of sweet orange cv. Pera were selected. They showed a lower intensity of symptoms of citrus canker in leaves and fruits in evaluations under natural incidence of the disease, in the field. The objective of this study is to assess the resistance to citrus canker of six mutant clones of cultivar Pera and control plants (three different varieties), in experiments of artificial inoculation. The parameters evaluated were: incubation period, diameter of the lesions and area under the disease progress curve (AUDPC), in evaluations every 15 days, until the 147th day. Only the clones 9-1, 9-2 and 9-3 showed lower incidence of disease, represented by the longest period of incubation of the disease, smaller diameter of lesion and lower AUDPC, using average data of the three experiments. This study is one of the first reports of success in citrus-induced mutations aimed to obtaining greater resistance to diseases.

Introduction

The citrus industry can be considered as one of the most globalized segments of Brazilian agribusiness. Most of its production is exported thus bringing more than 2.5 billion USD to the country every year [1]. One of the main products of the Brazilian Citrus Industry is frozen concentrated orange juice (FCOJ), which represents over 80% of the world's export [1]. In Brazil, oranges represent 89.3% of the production of citrus species, followed by mandarins, with 5.8%, and limes and lemons with 4.9%.

Asiatic citrus canker (ACC) is one of the most serious diseases of citrus species [2, 3]. Caused by *Xanthomonas citri* subsp. *citri*, the pathogen is distributed in many countries and can infect plants of the *Rutaceae* family [4]. It is a quarantine disease with regulated trade of fruits between countries by measures of exclusion, aimed at preventing the pathogen entrance in areas free of disease [2, 5, 6].

The first occurrence in Brazil was in 1957, in Presidente Prudente, São Paulo State [7], and was subsequently spread to almost the entire country [8, 9, 10]. Measures of exclusion and eradication were adopted in the same year in the form of a campaign for eradication of infected trees that remains active until the present days [11, 12]. The only exception occurs in Parana State, where the eradication is not mandatory, but the adoption of disease management practices is accepted, such as application of cupric agrochemicals and protection by windbreak curtains [13].

Citrus canker disease is characterized by the formation of circular and water soaked lesions that become raised and blister-like, growing into yellow spongy pustules, then to darken and thicken into a light tan to brown canker, often surrounded by a chlorotic halo [7]. On heavily infected trees, citrus canker causes defoliation and premature fruit drop in the most susceptible varieties [14, 15].

All citrus varieties are susceptible to citrus canker. Grapefruit, acid limes and lemons are highly susceptible. Sour oranges and oranges are moderately susceptible, while mandarins are termed moderately resistant [16]. In experiments with artificial inoculation it was shown that susceptibility varies according to the tissue infected and to the different modes of infection [17, 18, 19]. Young leaves and fruits are more susceptible than mature tissues [20], and inoculation methods that cause direct contact of the bacteria with mesophyll cells (pinprick inoculation, for example) are more efficient, often resulting in disease [21].

More resistant cultivars are the best long-term solution for citrus canker management. One of the approaches can be the induction of mutants. Mutant plants of citrus have been experimentally induced in several countries. The main characteristics selected were seedlessness or reduction in the number of seeds [22, 23, 24, 25], absence of thorns [22], better color of fruits [23], salinity tolerance [26] and increased resistance to diseases [27].

In a previous work, [28] reported the selection of 12 sweet orange mutant clones with less intensity of citrus canker symptoms in leaves and fruits. These mutants were obtained from mutagenic treatment with Gamma-rays and with selection in field conditions, on natural incidence of the disease. Two of those clones (9 and 41) were confirmed as more resistant to citrus canker, after five years of evaluation in the field [27].

The objective of this study was to assess the resistance to citrus canker of three mutant clones of orange Pera selected by [28], in experiments with artificial inoculation by wounding.

Materials and Methods

In the present study, we evaluated the resistance of six mutant clones of 'Pera' (numbers 9-1, 9-2, 9-3, 42-2; 61-1 and 61-2), four non-mutant clones of 'Pera' ('Pera Fischer', 3-1, 3-2 and 3-3), and three control genotypes, in experiments with artificial inoculation. The control plants used were 'Ponkan' mandarin (highly resistant), 'Pera IAC' sweet orange (control non-irradiated - medium resistant) and 'Hamlin' sweet orange (less resistant).

The experiment was carried out using a randomized design with four replications, each consisting of four one-year-old plants, maintained in vessels (4L), in a greenhouse. Plants were pruned 90 days before inoculation.

Ten leaves per plant were inoculated by pinprick inoculation using a needle (0.55 x 0.2 mm) previously immersed in a 10⁶ CFU mL⁻¹ of bacterial suspension (strain IBSBF 1421). Each leaf was pricked six times. Plants were kept under a humid condition in growth chambers for 18 hours after inoculation and then, transferred to a greenhouse. The experiment was repeated three times.

¹ Depto. Científico, Fundecitrus, Araraquara, Brasil

² Centro APTA Citros Sylvio Moreira-IAC, Cordeirópolis, Brasil

³ Centro de Energia Nuclear na Agricultura, Piracicaba, Brasil

*Corresponding author. E-mail: rodrigo@centrodecitricultura.br

The parameters evaluated were: a) Incubation period (number of days after inoculation to visualize at least one lesion in more than 50% of the inoculated leaves), b) Average diameter of the lesions, measured in four lesions taken at random at 15-day intervals for a period of 147 days, and c) Area under the disease progress curve (AUDPC) that was calculated from the average diameter of the lesions, in the same period of time (147 days). This parameter allows a comparison between treatments considering the whole assessment period.

Treatments were compared in pairs. Linear regression equations were fit to data for lesion diameter obtained in each treatment for each experiment. The curves were compared by analysis of variance (F test for coincidence between curves) and the angular coefficient (b) of each curve was also compared using *t* test (for parallelism between curves), separately for each experiment. Incubation period and AUDPC data were analyzed by ANOVA and means were compared using Tukey test ($P \leq 0.05$).

Results and Discussion

All plants showed disease symptoms but with large variability among treatments. The incubation period of all treatments ranged from eight to 12.8 days after inoculation (DAI), on average in the three experiments. The first genotype that showed lesions was Hamlin, after 9.2 DAI, while in Ponkan the incubation period was 10.7 DAI (Fig. 1). Four mutant clones, 'Pera Fischer' (non-mutant clone) and the control genotype (Pera IAC) did not show symptoms before 10 DAI. Mutant clone 9-3 was the only one that showed an incubation period longer than 11 days (11.2 DAI).

The inoculum concentration (10^6 CFU mL⁻¹) was appropriate in carrying out the screening between resistant and susceptible genotypes. Optimum inoculum density needed for infection varies depending on the mode of infection, [21] having recommended 10^4 and 10^5 CFU mL⁻¹ for infection via stomata (without wounding) and 10^2 CFU mL⁻¹ for infection by wounding. However, other authors used larger concentrations for screenings of resistance in citrus varieties using pinprick inoculation. Vilorio, *et al.* [29] only saw consistent differences between genotypes after increasing the inoculum concentration from 10^3 to 10^4 CFU mL⁻¹, while [30] used 10^6 CFU mL⁻¹ to assess citrus canker resistance of somatic hybrids between Hamlin sweet orange x Montenegro mandarin, and [31] evaluated ACC resistance of 54 citrus species using pinprick inoculation method with inoculum concentration of 10^8 CFU mL⁻¹.

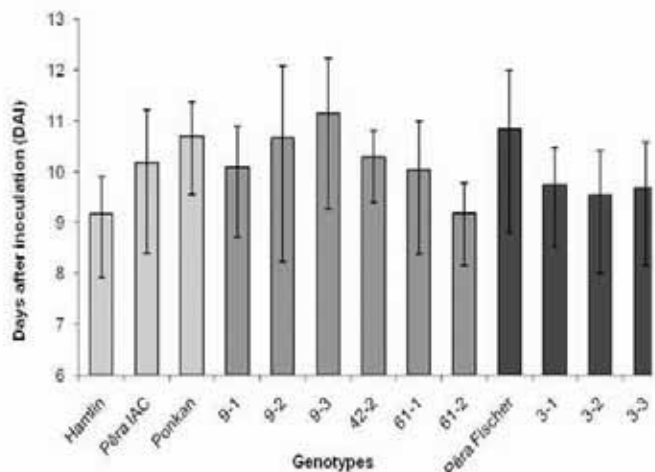

Figure 1 Incubation period up to lesion occurrence. Values represent average of three experiments.

The diameter of lesions increased in all treatments throughout the evaluation period of the experiment, which extended for 147 DAI (Fig. 2).

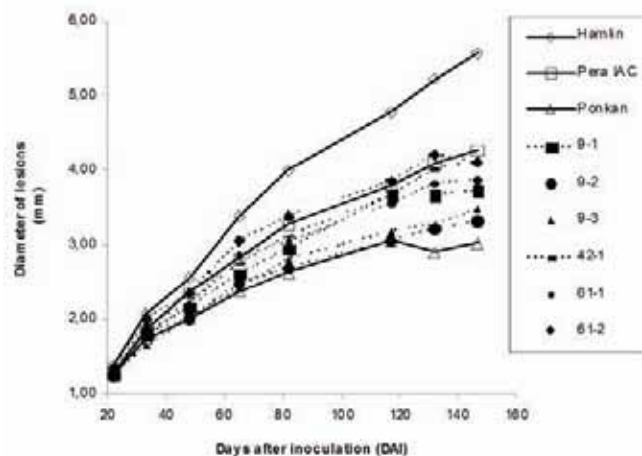

Figure 2 Diameter of lesions, measured for four lesions taken at random, at 15-day intervals until 147 days. Values represent the average of three experiments.

The ranking of genotypes, based on the assessment of lesion diameters, was the same in the three experiments. 'Hamlin' sweet orange showed lesions with greatest diameter (average of 5.6 mm, in 147 days), while 'Ponkan' mandarin was the genotype with the smallest lesions (3.0 mm, in 147 days). Among the mutants, only clones 9-1, 9-2 and 9-3 showed lesions with diameters significantly lower (3.3 to 3.7 mm) compared to 'Pera IAC' sweet orange (non-irradiated control - 4.3 mm) and similar to 'Ponkan' (3.0 mm). The other mutants and non-mutated clones showed no differences in relation to control plants (Pera IAC).

The results observed for the diameter of lesions confirm observations made by [16] that Ponkan mandarin is more resistant to infections by citrus canker and sweet oranges are more susceptible, but with differences among varieties. Hamlin, that is considered one of the most susceptible sweet orange varieties to citrus canker, showed lesions with larger diameter in all experiments, while Pera IAC and Pera Fischer had intermediate resistance.

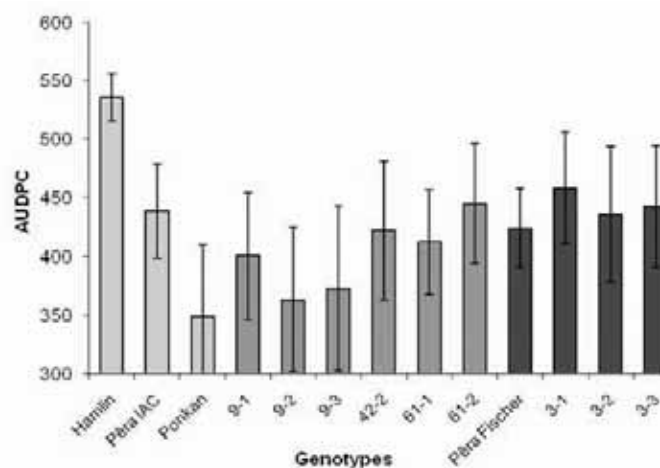

Figure 3 Area under disease progress curve (AUDPC), calculated from average diameter of the lesions of citrus canker. Values represent the average of three experiments.

The average AUDPC value obtained for Hamlin was higher than all other genotypes (536 ± 35) in all experiments, while smaller values were observed for 'Ponkan' (349 ± 104) and for three mutant clones (9-2, 9-3 and 9-1 - 363 ± 106 to 401 ± 93) (Fig. 3). Mutant 9-3 was the only one that did not differ from 'Ponkan' in all experiments, while mutants 9-2 and 9-1 differed in one or two experiments. Other mutant and non-

mutant clones did not differ from 'Pera IAC' in some experiments, nor when we analyzed the data as an average of the three experiments.

AUDPC is the most complete and informative variable for epidemiological studies and for studies of resistance of citrus canker, because it can retain maximum information such as disease onset, rate of increase and final disease incidence [21].

The causes of increased resistance of plants to direct inoculation of citrus canker in mesophyll are not fully clarified [31]. According to [21], the greater resistance of leaves by wounding inoculation may be associated with the process of healing, tissue age or other mechanisms of resistance because, in this type of inoculation, bacteria can be put directly in contact with the leaf mesophyll tissue. In leaves with maximum size or with two thirds of their maximum size, it has been proven that the increased resistance is correlated to water congestion [21], while [32] considered that in mature leaves, the mesophyll resistance is expressed by limitation of the multiplication of bacteria, which varies between species and cultivars.

The results obtained in all experiments suggest that mutant clones 9-1, 9-2 and 9-3 have higher resistance to citrus canker than control plants, comparable to that observed in 'Ponkan' mandarin (the most resistant cultivar) under conditions of artificial inoculation. Other experiments will be conducted to assess the fruit yield of these mutants and the resistance to citrus canker in field experiments, under natural infection. If they show yield and fruit quality suitable for commercial use, these mutant clones should be recommended for regions where citrus canker is endemic.

This study is one of the first reports of success in the induction of mutations in citrus aimed at obtaining greater resistance to diseases.

BIBLIOGRAPHY

1. FNP. *Agrianoal 2007: anuário da agricultura brasileira*. São Paulo: FNP, 516p. (2007).
2. Gottwald, T.R. *et al.* The citrus canker epidemic in Florida: The scientific basis of regulatory eradication policy for an invasive species. *Phytopathology* **91**, 30-34 (2001).
3. Stall, R.E., Seymour, C.P. Canker, a threat to citrus in the gulf-coast states. *Plant Dis.* **67**, 581-585 (1983).
4. Civerolo, E.L. Bacterial canker disease of citrus. *J. Rio Grande Valley Hort. Soc.* **37**, 127-146 (1984).
5. Civerolo, E.L. Citrus bacterial canker disease: The bacterium *Xanthomonas campestris* pv. citri. In: Citrus Canker: An International Perspective, Lake Alfred, 1985. Citrus canker: An international perspective. Lake Alfred: Citrus Research and Education Center, University of Florida, 11-17 (1985).
6. Schoulties, C.L. *et al.* Citrus canker in Florida. *Plant Dis.* **71**, 388-395 (1987).
7. Bitancourt, A.A. O cancro cítrico. *O Biológico* **23**, 1957 (1957).
8. Barbosa, J.C. *et al.* Incidência e distribuição de cancro cítrico em pomares comerciais do Estado de São Paulo e sul do Triângulo Mineiro. *Summa Phytopath.* **27**, 30-35 (2001).
9. Nascimento, J.F. *et al.* Ocorrência de cancro cítrico no estado de Roraima. *Summa Phytopath.* **29**, 81-82 (2003).
10. Porto, O. *et al.* Ocorrência de cancro cítrico no Rio Grande do Sul. (Proc. Congress Brasil. Frutic., Recife, 1981. Anais. Recife: Sociedade Brasileira de Fruticultura, 1386-1388 (1981).
11. Gimenes-Fernandes, N. *et al.* Plantas doentes não detectadas nas inspeções dificultam a erradicação do cancro cítrico. *Summa Phytopath.* **26**, 320-325 (2000).
12. Massari, C.A., Belasque Junior, J. A campanha de erradicação do cancro cítrico no estado de São Paulo – Situação atual e contaminação em viveiros. *Laranja* **27**, 41-55 (2006).
13. Leite Junior, R.P. Mohan, S.K. Integrated management of the citrus bacterial canker disease caused by *Xanthomonas campestris* pv. citri in the State of Paraná, Brazil. *Crop Protection* **9**, 3-7 (1990).
14. Gottwald, T.R. *et al.* Asiatic citrus canker: spatial and temporal spread in simulated new planting situations in Argentina. *Phytopath.* **78**, 739-745 (1988).
15. Gottwald, T.R. *et al.* Analysis of disease progress of citrus canker in nurseries in Argentina. *Phytopath.* **79**, 1276-1283 (1989).
16. Gottwald, T.R. *et al.* Citrus canker: the pathogen and its impact. Online. *Plant Health Progress*. DOI: 10.1094 / PHP-2002-0812-01-RV. (2002). <<http://plantmanagementnetwork.org/pub/php/review/citruscanker/>>.
17. Gottwald, T.R., Graham, J.H. A device for precise and non-disruptive stomatal inoculation of leaf tissues with bacterial pathogens. *Phytopath.* **82**, 930-935 (1992).
18. Graham, J.H. *et al.* Penetration through leaf stomata and growth of strains of *Xanthomonas campestris* strains in citrus cultivars varying in susceptibility to bacterial diseases. *Phytopath.* **82**, 1319-1325 (1992).
19. Graham, J.H. *et al.* Susceptibility of citrus fruit to bacterial spot and citrus canker. *Phytopath.* **82**, 452-457 (1992).
20. Canteros, B.I. Changes in the resistance of developing citrus fruit to canker. *Proc. Int. Soc. Citriculture* **2**, 825-827 (1992).
21. Verniere, C.J. *et al.* Disease development and symptom expression of *xanthomonas axonopodis* pv. citri in various citrus plant tissues. *Phytopath.* **93**(7), 832-843 (2003).
22. Spina, P. *et al.* Use of mutagenesis at the Instituto Sperimentale per Lagrumicoltura Acireale: Results and prospects for the future. (Proc. Inter. Symp. Contribution Plant Mutat. Breed. Crop Improvement) Vienna: IAEA, 257-261 (1991).
23. Hensz, R.A. Mutation breeding of grapefruit (*Citrus paradisi* Macf.) (Proc. Inter. Symp. Contribution Plant Mutat. Breed. Crop Improvement) Vienna: IAEA, 533- 536 (1991).
24. VARDI, A. *et al.* New considerations on the choice of irradiation dose rate in Citrus. In: International Agency of Atomic Energy. (IAEA) Induced Mutations and Molecular Techniques for Crop Improvement, Vienna 667-670 (1995).
25. Latado, R.R. *et al.* Mutantes de laranja Pera com número reduzido de sementes, obtidos através de mutações induzidas. *Rev. Brasil. Frutic.* **23**(2), 339-344 (2001).
26. Wang, L.Q. Induced mutation for crop improvement in China: A review. (Proc. Inter. Symp. Contribution Plant Mutat. Breed. Crop Improvement) Vienna: IAEA, 9-32 (1991).
27. Latado, R.R. *et al.* Seedless and citrus canker tolerant mutant clones in sweet orange induced by gamma rays. *Plant Mut. Rep.* **1**(2), 21-22 (2006).
28. Tulmann Neto, A. *et al.* Indução e seleção de mutantes de laranja Pera mediante o emprego de radiação gama. *Pesq. Agropec. Brasil.* **31**(10), 743-752 (1996).
29. Vilorio, Z. *et al.* Screening triploid hybrids of 'lakeland' limequat for resistance to citrus canker. *Plant Dis.* **88**(10), 1056-1060 (2004).
30. Pavan, A. *et al.* Evaluation of 'Hamlin' sweet orange + 'Montenegrina' mandarin somatic hybrid for tolerance to *Xanthomonas axonopodis* pv. citri and *Xylella fastidiosa*. *Scientia Hort.* **113**, 278-285 (2007).
31. Gottwald, T.R. *et al.* Differential host range of citrus and citrus relatives to citrus canker and citrus bacterial spot determined by leaf mesophyll susceptibility. *Plant Dis.* **77**, 1004-1009 (1993).
32. Stall, R.E. *et al.* Importance of mesophyll in mature-leaf resistance to canker of citrus. *Phytopath.* **72**, 1097-1100 (1982).

Use of Irradiation for the Induction of Mutations in Oyster Mushrooms for Improvement of Strains

P Huzar Fatty Beejan* & R Nowbuth

Abstract

In order to induce mutants with improved characteristics in terms of good yield and adaptability to a wider range of temperatures, five parent strains of *Pleurotus*, a species of edible mushroom, were subjected to gamma and UV irradiation. Mycelial plugs of the actively growing parent strains were subjected to doses of gamma radiation ranging from five to 400Gy using a ^{134}Cs radioisotope. Irradiated mycelia were assessed in laboratory experiments and were used to prepare mother flasks, spawn and fruiting bags for production experiments. Certain stimulatory effects of gamma-irradiation were noted on mycelial growth rate and yield of fruiting bags at different doses. However, these effects were not consistent. Similarly, for UV irradiation, multispore suspensions of the five parent strains were subjected to exposure times varying from three to 20 hours to UV-rays. After plating, vigorously growing mycelia were evaluated in laboratory assessments and production trials. Decreased viability was noted in several strains after repeated subcultures and storage. Viable UV-irradiated strains exhibited similar stimulatory effects as in gamma irradiation at certain exposure times. Again, an erratic effect at varying exposure times was noted. Based on these results, irradiated strains showing stimulatory effects on mycelial growth and yield have been selected for further evaluation at different agroclimates in Mauritius as well as for other breeding work.

Introduction

Oyster mushrooms (*Pleurotus* sp) are edible fungi, commercially cultivated for consumption worldwide. Mauritius imports various mushrooms, both fresh and processed, to a value amounting to around one million euro annually. This demand is supplemented by the local production, on a major part, of oyster mushrooms. Oyster mushroom cultivation in Mauritius is chiefly carried out in low cost growing houses at ambient conditions with no temperature and humidity control. As such, mushroom productivity is heavily dependent on agroclimatic conditions occurring in different areas of the island and on the seasonal variations. Mushroom growth and adaptability as well as quality and quantity produced are intrinsically linked to temperature, which is an important factor in mushroom development [1]. It would be beneficial to local producers to have oyster mushrooms strains adapted to a wider range of temperatures for their development and fruiting phases as well as strains of a higher productivity at a particular agroclimate. For seasonal mushroom growers, improved strains with better adaptability to a range of temperatures will enable an extension of their growing season or even year round production. Identification of higher yielding strains at low, medium or high temperatures will increase the productivity and eventually the revenue of growers. Thus, the cultivation of better-adapted strains for each agroclimate will help to ensure optimal mushroom development and yield. This can lead to an increase in local production

and a decrease in importation. Mutation breeding of oyster mushroom strains available in Mauritius was selected in order to increase the potential of obtaining strains with desirable characteristics.

Five *Pleurotus* mushroom strains were selected from the 52 strains maintained at the Culture Collection (CC) of Agricultural Research and Extension Unit detailed in [2]. The selection procedure was based on the fitted model of mycelium growth of these strains at eight different temperatures ranging from 13° to 34°C. Two *Pleurotus sajor-caju* strains, CC 46 and CC 116, were selected for good performance at low temperatures (16°-19°C). Similarly, *P. columbinus* (CC 66) and *P. hybrid* (CC 71) showing good mycelial growth rate at higher temperatures (28°-31°C) and the commercially cultivated *P. sajor-caju* CC 114 were selected for breeding and improvement purposes.

The principal aim of this study was to improve the five selected strains of oyster mushroom by irradiation to induce mutations. Two types of irradiation, namely irradiation using Gamma-ray and UV radiation were used in order to attempt to improve the five promising parent strains.

Materials and Methods

The work was divided into two distinct steps. The first consisted of the laboratory procedures including the induction of mutagenesis using irradiation, subculture of irradiated strains and mycelial growth assessment as per the procedure described in [2]. For all laboratory culture preparations and for plating for vegetative growth assessment of strains, Potato Dextrose Agar (PDA) medium (Hi Media laboratories, India) was used. Media and glassware were autoclaved. All mycelium transfers and culturing were carried out in aseptic conditions under a laminar flow hood. The second step consisted of the evaluation of irradiated strains in production trials. This involved multiplication of irradiated strains by the production of mother cultures followed by spawn and fruiting bag production for evaluation of mushroom yield.

Laboratory experiment

Induction of mutation in oyster mushrooms using gamma irradiation

The five parent strains were aseptically inoculated on PDA petridishes and incubated at $25^{\circ}\pm 1^{\circ}\text{C}$ for five days. From the perimeter of the actively growing culture, mycelium covered agar plugs of 6 mm diameter were aseptically excised using a cork borer. Each plug was centrally inoculated onto a PDA petridish (diameter 50mm). The Gammator Cesium-137 was used to subject four replicated petri-dishes per strain to each dose of gamma irradiation (ranging from five to 400Gy). Exposure time was determined for each dosage of irradiation. After irradiation, petri-dishes were placed in an incubator set at $25^{\circ}\pm 1^{\circ}\text{C}$. The rate of mycelial colonization was noted.

Induction of mutation in oyster mushrooms using UV irradiation

Multispore suspensions were used for UV irradiation. Only mature carpophores harvested from the first flush of the five parent strains were used to produce spore prints. Suspensions were obtained by streaking an inoculating needle on spores from spore prints into sterile distilled

Crop Department, Agricultural Research and Extension Unit, Quatre Bornes, Mauritius

* Corresponding author. E-mail: areucrop@intnet.mu

water. Before exposure to mutagenic treatment, the optimal multispore dilution level was determined, by evaluating four dilution levels (undiluted, 10^{-1} , 10^{-2} , 10^{-3}). The 10^{-1} multispore dilution level was selected for future work based on the incidence of fungal colony formation upon streaking of suspension onto a PDA petri-dish.

Spore suspensions of the five parent strains at 10^{-1} dilution level were subjected to varying periods of exposure to UV irradiation. Test tubes of spore suspensions were subjected to irradiation from the UV lamp within a laminar flow hood for seven exposure periods (0, 3, 6, 9, 12, 18, 20 hours). This procedure was carried out in darkness to inhibit photo-reactivation. After irradiation, spore suspensions were plated and incubated at $25^{\circ} \pm 1^{\circ}\text{C}$. The growth of surviving spores was noted. Actively growing mycelia from these developing spores were then subcultured followed by rate of growth evaluation.

Production experiment

Both the UV and gamma (0, 100, 200, 300, 400Gy) irradiated strains were assessed in production trials for their ability to fructify and their yield. All strains were subcultured onto PDA petri-dishes. Agar plugs were cut out and used to inoculate mother spawn flasks. The latter consist of a sterilized millet, talc, calcium carbonate and sugar cane bagasse medium. After inoculation, flasks were incubated at $25^{\circ} \pm 1^{\circ}\text{C}$. The time taken for complete colonization was noted. Mother spawn flasks were then used for the inoculation of sterilized spawn bags comprising of a maize seeds, bagasse and lime media. Spawn bags were incubated in a darkened room at ambient temperature. The rates of colonization of spawn bags were noted. Standard bagasse based substrate for local oyster mushroom cultivation comprising of bagasse, crushed maize and lime was prepared and pasteurized at 60° to 70°C . After cooling, the fruiting bags were inoculated with the colonized spawn. Each replicate spawn was used to inoculate nine fruiting bags of 0.75 kg capacity and seven bags of 3 kg capacity. These bags were allowed to colonize in an incubation room. After spawn run, bags were transferred to a growing house and fructification was initiated. Regular daily spraying of water was carried out. Yield of fruiting bodies from bags of each strain were noted. Production experiments were replicated over time for confirmation of observation and outcome.

Results

The highest gamma irradiation dose used in the laboratory experiments to induce mutation in oyster mushroom strains was 400Gy. At this dose, no mortality was induced in the five *Pleurotus* parent strains and all irradiated mycelial plugs successfully showed growth onset and mycelium development. Analysis of rates of mycelial growth during petridish incubation showed that increases in gamma irradiation dose beyond 200Gy resulted in a decrease in vegetative growth. There was not much difference in growth rate in doses below 200Gy. Doses of 300Gy and 400Gy resulted in a slight decrease in growth rate reflected in a longer time taken for media colonization, i.e. to reach a radial mycelial diameter of 50 mm (from seven to eight days for unirradiated and doses of less than 200Gy up to 14 to 15 days for 400Gy).

For UV-ray irradiation, the multispore dilution level of 10^{-1} was determined to be optimal for plating of spore cultures. After irradiation, a good spore survival rate was observed in irradiated strains with the exception of CC 71 irradiation duration 18 hours and CC 66 irradiation duration 12 hours, which showed no spore survival. Actively growing mycelia from surviving spores were transferred to fresh PDA medium for further evaluation. All UV and gamma-irradiated strains were also assembled in a culture collection. It was observed that some irradiated strains showed loss of vitality over a two-year period and were not included in further trials.

The mother spawn flasks prepared from all viable gamma and UV-irradiated strains for production experiments, took on average four

days for onset of mycelial growth, and colonization was completed on average in 11 days. The time taken for colonization of strain CC 116 UV-irradiated for three hours was 18 days, with onset of growth noted after five days. CC 46 irradiated at 100Gy showed faster colonization rate (nine days) compared with the unirradiated and the three higher irradiation doses of 200, 300 and 400Gy. The colonization rates for the respective (conventional 0.75 kg) spawn bags, however, varied greatly, and ranged from 21 to 35 days. No definitive trend alterations in spawn colonization rates were observed with increasing gamma-radiation doses or with increasing exposure time to UV radiation. For instance, colonization rate of CC 71 subjected to 0, 100, 400Gy gamma-radiation was 21 days with a marginal increase in replicate colonization rate (25 days) at a dose of 200Gy. Moreover, time taken for colonization of CC 46 irradiation doses 0, 200, 300Gy was 35 days, with a marginal decrease of three days noted at an irradiation dose of 100Gy. Increasing UV radiation exposure duration of CC 116 resulted in a decrease of colonization rate (from 27 days for unirradiated strain to 22 days for 18 hours UV radiation exposure). The strains subjected to gamma or UV radiation likewise exhibited alterations in colonization rates of fruiting bags. Similarly to spawn bags, no smooth trend was noted in the colonization rates of both the 0.75 and 3 kg fruiting bags. For example, time taken for colonization of fruiting bag of 0.75 kg of CC 46 (0Gy) decreased from 22 days for the unirradiated to 20 days after irradiation at 100Gy, followed by an increase in time taken at higher gamma-radiation doses. However, no change in time taken for colonization (33 days) was noted in gamma-irradiated CC 66 fruiting bags of 3 kg capacity unlike those of 0.75 kg. Furthermore, it was also noted that strains such as UV-irradiated CC 71 (six hours exposure) and gamma-irradiated CC 66 (100Gy) failed to colonize adequately.

The color of pilei surface and the gross morphology of the fruiting bodies of the irradiated strains were not markedly different from the original parent types. It was noted that CC 46 and 66 generally fructified later than the other parent strains. For ease of comparison, yield from the two sizes of fruiting bags were worked out per kilogram of substrate.

For gamma-irradiated strains, analysis of variance (two factors without replication at $p \leq 0.05$) of the compiled results of fruiting bodies yields was carried out. No significant difference in average number of fruiting bodies produced was obtained with respect to the gamma-radiation treatment. Average number of fruiting bodies varied significantly with respect to the fruiting bag type and strain. Fruiting bags of 0.75 kg produced numerous (average 17) but smaller fruiting bodies as compared 3 kg bags producing less in number (6) but larger fruit size. Strain CC 71 produced a higher number of fruits (23.5) than strains CC 46 and 66 as well as CC 114 and 116.

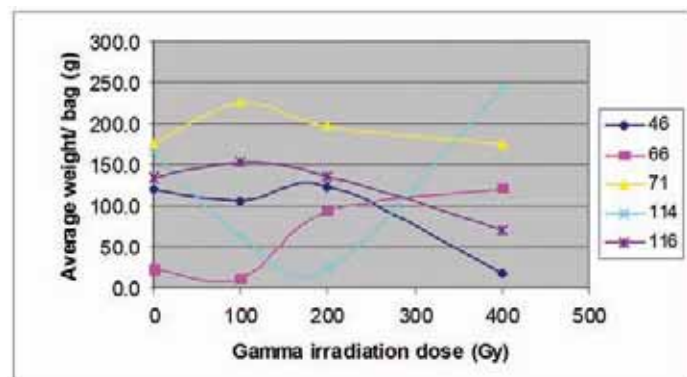

Figure 1 Average weight of oyster mushrooms obtained per kilogram of substrate from fruiting bags of 0.75 kilogram capacity for the five parent strains irradiated with Gamma-rays at doses 0-400Gy.

As shown in Fig. 1, the average total weight of fruiting bodies is influenced by different irradiation dosages for the parent strains. The analysis of variance of average fruiting bodies yield per kilogram of substrate indicated a significant difference, which was influenced by irradiation dosage, parent strain and size of the fruiting bag. The average weights of fruiting bodies obtained per kilogram of fruiting bag substrate irrespective of size of bag are summarized in Table 1.

In the case of UV irradiation, several strains showed loss of viability subsequent to subculture and storage as a result of which insufficient strains with different exposure times remained for possible comparison. CC 116 with exposure times of zero to 18 hours was the exception. The analysis of variance of the production results indicated that no significant difference in yield per kilogram of substrate occurred following exposure at varying periods to UV radiation. However, yield varied significantly with respect to fruiting bag size such that per kilogram of substrate, bags of 0.75 kg produced greater number of fruiting bodies (13 compared to 4 from 3 kg bags) and a higher average weight per bag (107g compared to 52 g from 3 kg bags).

Table 1. Yield of fruiting bodies of *Pleurotus* mushrooms harvested per kg of fruiting bag substrate after induced mutation using gamma radiation

Strain	Average Yield (g)			
	0 Gy	100 Gy	200 Gy	400 Gy
CC 46	109.8	97.1	120.2	24.6
CC 66	8.5	12.6	94.1	126.0
CC 71	180.9	203.6	176.3	168.2
CC 114	142.2	36.7	161.7	218.2
CC 116	94.5	110.1	120.0	44.4

Discussion and Conclusion

Gamma radiation induced mutants have been reported in several works on *Pleurotus* sp [3-5] and the use of UV-ray irradiation has been reported in others [6-7]. In the present study, it was demonstrated that improvement of parent strains of oyster mushroom could be induced by artificial mutagenesis using both gamma radiation and UV radiation. Mutation breeding of *Pleurotus* species by subjecting non-sexual spores and hyphal segments (mycelial plugs) to irradiation, a physical mutagen, so as to create variants as defined in [8], was carried out.

In this study, mycelial plugs were subjected to gamma radiation doses to a maximum of 400Gy after which all plugs showed mycelial growth during incubation. This indicates that the doses used were below the lethal doses for the parent strains. This is in line with the results of [4] where lignocellulolytic mutants were irradiated to doses of 1 to 2 kGy with no strain mortality. As discussed in [3], faster mycelial growth, decreased spawn run time and increased productivity in terms of yield were noted after gamma irradiation of *P. sajor-caju* spawn at 0.1 to 0.25 kGy. In this study, no changes in mycelial growth rate in petridishes were noted after irradiation up to 200Gy. At higher doses though, a marginal inhibitory effect on mycelial growth rate was noted. A stimulatory effect of gamma-irradiation on mycelial growth rate at the mother spawn and spawn bag level and decreased colonization time during spawn run as seen in [3] were noted in certain cases. For instance, gamma irradiation of CC 46 at 100Gy increased mycelial growth rate so that colonization was completed in nine days instead of the mode of 11 days. An increase in average yield of fruiting bodies was also noted following gamma irradiation at specific doses (CC 114 irradiated at 400Gy, CC 116 at 200Gy and CC 46 at 200Gy, etc). However, these stimulatory effects were neither consistent for the different parent strains throughout all the gamma radiation doses nor through the different stages of laboratory and production experiments. Erratic trends and slight inhibitory effects

of both irradiation types were noted. This may be due to the limitations of mutation breeding [9] in its basic form. These limitations arise due to the random and undirected nature of mutations as well as the possible occurrence of 'unsolicited' mutations having no bearing on the breeding objectives. Irradiation-induced desirable mutation in a cell not contributing to the next generation, decreased cellular fitness, poor regeneration after irradiation, chromosomal damage, chimerism especially in the case of use of mycelial plugs, can all be possible reasons accounting for the erratic trends in growth rate and yield of oyster mushroom.

Pleurotus species exhibit bifactorial heterothallism [10] and as such, their single spore cultures are sterile. Multispore cultures were thus chosen for UV-ray irradiation. The presence of clamp connections indicating fusing of compatible hyphae [8] were sought in order to select actively growing mycelium from irradiated spores. All UV irradiated strains showed mycelial growth after subculturing on PDA. After repeated subcultures and storage in the Culture Collection over the course of two years, it was observed that several UV irradiated strains lost their viability and failed to show mycelial growth when plated and incubated. This differs from the stable mutant character of UV irradiated strain maintained over more than 10 generations of subculturing as reported in [7]. This may be due to the lower exposure period of 75 minutes to UV-rays in [7], or to a faster degeneration of multispore cultures propagated by mycelial cultures than the single spore cultures explained by Fritsche as reported in [11]. A stimulatory effect similar to that of the reported Gamma-ray irradiation was also noted in the surviving UV irradiated strains. Increasing exposure times to UV radiation stimulated yield in certain cases. However, due to insufficient strain survival, a detailed analysis was not possible.

In production experiments, fruiting bags of smaller size, of 0.75 kg capacity, generally showed better productivity. This may be attributed to faster substrate colonization and less susceptibility to contamination of smaller bags, or to improved substrate utilization.

To conclude, it has been demonstrated that irradiation can improve oyster mushroom strains. Yield has shown to enhance for certain strains after different types of irradiation, different doses or different exposure times. Also the inherent productivity of strain CC 71 was found to be higher than that of CC 114, the actual commercial oyster mushroom strain, and can be considered as a potential substitute. All promising irradiated strains identified in these experiments will be evaluated during successive production experiments and will be assessed for growth and yield in different agroclimates for identification of better suited strains for each agrozone of Mauritius.

ACKNOWLEDGEMENTS

The authors thank the Food and Agricultural Research Council, Mauritius for funding the research project.

BIBLIOGRAPHY

- Daba, A.S., Mushroom Cultivation in Egypt. Foods of the Gods down the Nile Valley, Mushroom Int, 105, (2006).
- Huzar Fatty Beejan, P., Nowbuth, R. Development of a model for the evaluation of temperature adaptability of oyster mushroom strains. (Proc. Research Week 2007, Mauritius), Sci Technol Res J -Univ Mauritius, Mauritius (in press).
- Roy, M. K. *et al.* Gamma radiation in increasing productivity of *Agaricus bisporus* and *Pleurotus sajor-caju* and enhancing storage life of *P. sajor-caju*. *J Food Sci Technol* **37**, 83-86 (2000).
- Lee, Y-K. *et al.* Lignocellulolytic mutants of *Pleurotus ostreatus* induced by gamma-ray radiation and their genetic similarities. *Rad. Phys. Chem.* **57**, 145-150 (2000).
- Chang, H-H. *et al.* Mutation spectrum of manganese (II) peroxidase gene in the *Pleurotus ostreatus* mutants induced by gamma radiation. *J Microbiol* **41**, 52-57 (2003).
- Obatake, Y. *et al.* Isolation and characterization of a sporeless mutant in *Pleurotus eryngii*, *Mycosci* **44**, 33-40 (2003).

7. Ravishankar *et al.* Development of sporeless/low sporing strains of *Pleurotus* through mutation. *World J Microbiol Biotechnol* **22**, 1021-1025 (2006).
8. Bhandal, M.S., Mehta, K.B. Genetic improvement of *Pleurotus* species, *Advances in Mushroom Biotechnology* (NAIR, M.C., GOKULAPALAN, C., DAS, L., Ed.), Sci Publ, Jodhpur, India, 127-133 (1994).
9. Van Harten, A.M. Introduction to Plant Breeding: Genetic Variation. Part: Mutation Breeding. Int Course Appl Plant Breeding IAC Wageningen Agricultural University, (1991).
10. Roxon, J.E., Jong, S.C. Sexuality of an edible mushroom *Pleurotus sajor-caju*. *Mycologia* **69**, 203-205 (1977).
11. Mehta, K.B., Bhandal, M.S. Genetic improvement in the white button mushroom – *Agaricus bisporus*, *Advances in Mushroom Biotechnology* (NAIR, M.C., GOKULAPALAN, C., DAS, L., Ed.), Sci Publ, Jodhpur, India, 70-77 (1994).

The Breeding of *Arthrospira platensis* Mutants with Good Quality and High Yield Induced by Space Flight

X Hou*, Y Lu, Z Zhang & W Wang

Abstract

Arthrospira platensis mutant PNK-2 has been induced by space flight. PNK-2, with good quality and high yield, is suitable for outdoor large scale production. Compared with the initial ST-6, the helix number of PNK-2 was 12~18; the average length of algae body, thread pitch, helix width, diameter of trichome and the rate of large-scale production were 764.31 μ m, 52.98 μ m, 18.75 μ m, 6.02 μ m and 10g \cdot (m²·d)⁻¹, respectively, representing increase rates of 166.52%, 5.88%, 8.19%, 12.31% and 22.89%, respectively. The content of protein, chlorophyll, β -Carotene and phycocyanin in PNK-2 were 69.57%, 1.01%, 0.16% and 14.70%, respectively, with respectively raising rates of 8.31%, 8.60%, 6.67% and 6.68%. The γ -linolenic acid content of PNK-2, at 0.63%, was reduced by 3.08%. The results showed that PNK-2 was a new *A. platensis* strain with good quality and high yield.

Introduction

Spirulina is a photosynthetic, filamentous, spiral-shaped, multicellular cyanobacterium. It is particularly rich in protein and also contains carotenoids, vitamins, minerals, and essential fatty acids [1]. The nutritional composition of *Spirulina* is comprehensive and balanced for humans as a high-quality health product. Test tube and animal studies have demonstrated several properties of large amounts of spirulina or spirulina extracts, including antioxidant [2], antiviral [3], anticancer [4,5], anti-allergy [6,7], immune-enhancing [8], liver-protecting [9], blood vessel-relaxing [10], and blood lipid-lowering [11] effects. It is recommended as a fine food resource for humans by WHO and FAO.

The two most common species used for human consumption are *Spirulina maxima* and *S. platensis*. *Arthrospira platensis* is one of the two species of *Spirulina* that is applied for production. Its mutation is easily induced by environment factors such as temperature, radiation, etc. [12]. In order to improve the output and quality of *Spirulina* and decrease the cost of production, some new species had been bred by domestication, natural selection, and physical or chemical mutation [13,14].

Space mutation breeding is a new fast breeding technology. The biological material is taken to 200-400 km up into space by an airship or a return satellite. Variation occurs in space for factors such as microvacuums, cosmic rays, energetic particles, cosmic magnetic fields, microgravity, etc. The new idioplasm, material and species will be selected from the returning biological material. Space mutation breeding is characterized by inducing a high frequency and large amplitude variation, with good heredity and beneficial modifications [15].

Materials and Methods

Original *Spirulina*

ST-6, *Arthrospira platensis* (Shenzhen Nongke Group Corporation) was carried to space and returned in the 20th return S&T satellite of China.

Shenzhen Nongke Group Corporation, Guangdong, China, 518040

* Corresponding author. E-mail: houxueying@21cn.com - Tel: +86 755-83710821

Culture

Zarrouk culture indoors, NO.4 culture of Noneke (per liter culture components: sea salt 0.5g, urea 0.05g, NaHCO₃ 5g, NaNO₃ 0.7g, MgSO₄ 0.2g, FeSO₄ 0.01g, CaCl₂ 0.02g, H₃PO₄ 0.15g, KCl 0.5g, Na₂SO₄ 0.25g) outside.

Breeding

The returned *Spirulina* from the satellite was cultured at 25°C, illumination intensity 3200-4000 lx. After 30 d, robust trichomes with a helix number above 10 are separated by capillarity with the help of a microscope, and then cultured separately in a tube. The separating operation was repeated several times until the appearance of uniform, fast-growing trichomes with good quality of the species.

Comparison of growing speed

The selected species and original ST-6 were all inoculated in conical beakers at the same concentration (absorbance value at OD₅₆₀) and cultured stationarily, with the beaker shaken four times every day and the OD₅₆₀ value determined. The *Spirulina* was collected with the 50 eye silk cover after 336h. Test samples were prepared through rinsing, drying and weighing.

Determination of protein

The protein contents of samples were determined by Kjeldahl method for nitrogen [16].

Large-scale production

Large-scale production was carried in the *spirulina* farm of the Nongke base. Each pond area was about 1143 m². In order to obtain the best quality and most stable species, the shape, productivity and nutrient contents of *spirulina* must be determined and compared.

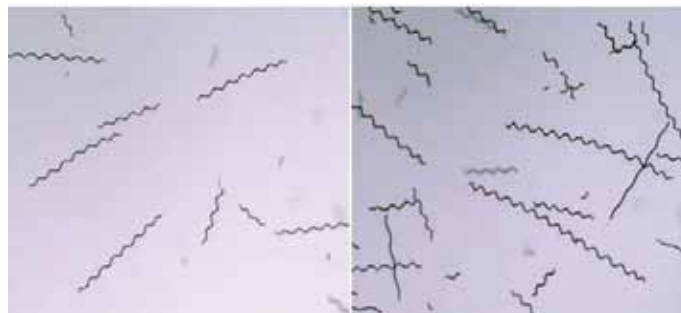

Figure 1 Differences of *A. platensis* mutants (left: before induction; right: after induction).

Results

Breeding of stable species

The space-mutated *spirulina* showed much variation in shape and length through the microscope observation (Fig. 1). Some were regular and robust, some linear and weak, others two to three times longer than the original.

Spirulina variation is mainly caused by the external factors. Cultured in an open environment, *spirulina* shows variations such as straightening, thinning and irregularity. However, space mutation could induce more significant changes in its shape and other aspects. Through single *spirulina* separation and breeding, seven stable shapes of *spirulina* species were obtained and numbered PNK-1 to PNK-7.

Selection of high yield species

Each species of PNK-1 to PNK-7 was inoculated in four bottles (500ml/ bottle). OD₅₆₀ value is the average of the four bottle sample. The results of one-factor analysis of variance are showed in **Table 1**. PNK-2, PNK-4 and PNK-5 were significantly different from ST-6. PNK-2 and PNK-5 were selected as the high yielding species due to OD₅₆₀ value at 280h and final biomass. The biomass of PNK-2 and PNK-5 increased 22.89% and separately in comparison with ST-6.

Table 1. Comparison of OD560 of different A.platensis

Species	Inoculation time/h						
	0	48	96	144	192	240	288
PNK-1	0.097±0.005	0.178±0.018	0.316±0.011	0.597±0.057	0.815±0.052	1.108±0.143	1.348±0.201 ^b
PNK-2	0.097±0.004	0.188±0.021	0.310±0.037	0.633±0.052	0.893±0.063	1.201±0.084	1.457±0.066 ^a
PNK-3	0.097±0.011	0.172±0.016	0.288±0.022	0.577±0.028	0.815±0.052	1.056±0.083	1.276±0.100 ^c
PNK-4	0.097±0.010	0.177±0.019	0.319±0.022	0.580±0.038	0.801±0.046	1.137±0.110	1.398±0.091 ^a
PNK-5	0.097±0.004	0.194±0.026	0.323±0.016	0.611±0.035	0.845±0.038	1.201±0.084	1.421±0.062 ^a
PNK-6	0.097±0.013	0.177±0.025	0.288±0.026	0.593±0.057	0.839±0.050	1.108±0.053	1.369±0.048 ^b
PNK-7	0.097±0.005	0.174±0.028	0.297±0.025	0.588±0.016	0.815±0.052	1.137±0.146	1.319±0.205 ^b
ST-6	0.097±0.007	0.163±0.026	0.271±0.029	0.547±0.037	0.714±0.047	0.921±0.096	1.164±0.137

^a P<0.01 (greatly significant difference),
^b 0.01<P<0.05 (significant difference),
^c P>0.05 (no significant difference).

Breeding of good quality species

The nutrients of *spirulina* were the significant standard of good quality. However contents of nutrients were affected by factors such as culture condition, collecting time and method [17]. PNK-2 and PNK-5 were cultured at a large scale and collected twice at logarithmic phase. The protein content of PNK-2 was 70.3% and 68.3%, and better than PNK-5 which had 68.7% and 64.7%.

Large-scale production

PNK-2 and ST-6 were cultured in the farm as a comparative trial for four batches. Comparative trial results are shown in **Table 2**. In the four batches comparative trial productivity of PNK-2 increased by 21.38%, 20.00%, 27.25% and 33.75%, separately than ST-6.

Spirulina is an exclusive photosynthetic autotroph. It can reduce the CO₂ to carbohydrate energized by light. Nutrition, temperature, light and pH can affect *spirulina* growth rate, output, chemical components and its contents. In fact, light is the major growth-limiting factor. Deficient sunshine on rainy days can weaken the photosynthesis of *spirulina* and lead to a lower output. In the outdoor trial, productivity of PNK-2 amounted to 9.55 and 9.62 g·(m²·d)⁻¹, respectively, at 50mm rainfall and 30mm rainfall. From **Table 2**, it can be concluded that PNK-2 has a high adaptability to the environment.

Morphological characters of PNK-2

PNK-2 and ST-6 had obvious differences in shape at logarithmic phase (**Fig. 3**). Compared with the initial ST-6: the helix number of PNK-2 was 12~18; the average length of algae body, thread pitch, helix width, diameter of trichome and rate of large-scale production were 764.31μm, 52.98μm, 18.75μm, 6.02μm and 10g·(m²·d)⁻¹, respectively with respec-

tive rates of increase of 166.52%, 5.88%, 8.19%, 12.31% and 22.89% against ST-6 (**Table 3**).

Table 2. Records of outdoor production data of A.platensis

Batch	Species	OD ₅₆₀			Quantity of dry powder (g)	Productivity g·(m ² ·d) ⁻¹	Weather
		Inoculation at 0 h	Collection	Filtrate			
1	ST-6	0.155	1.097	0.092	103000	8.19	1 d; rainfall 20 mm
	PNK-2	0.155	1.187	0.046	125000	9.94	
2	ST-6	0.167	1.125	0.108	105000	8.35	1 d; rainfall 15 mm
	PNK-2	0.167	1.222	0.056	126000	10.02	
3	ST-6	0.187	1.119	0.125	95000	7.56	2 d; rainfall 35 mm
	PNK-2	0.187	1.208	0.071	121000	9.62	
4	ST-6	0.180	1.131	0.143	98000	7.14	2 d; rainfall 50 mm
	PNK-2	0.180	1.268	0.086	131000	9.55	

Table 3. Comparison of morphology between PNK-2 and ST-6 (in μm)

Character	ST-6		PNK-2	
	Length range	Average length	Length range	Average length
Length of algae body	233.34~400.78	286.77±52.78	629.82~852.58	764.31±83.33
Thread pitch	48.28~52.11	50.04±1.38	50.93~59.00	52.98±2.71
Helix width	15.70~18.92	17.33±1.07	17.46~20.44	18.75±0.90
Diameter of trichome	5.07~5.66	5.36±0.20	5.83~6.42	6.02±0.18
Helix number	5~8		12~18	

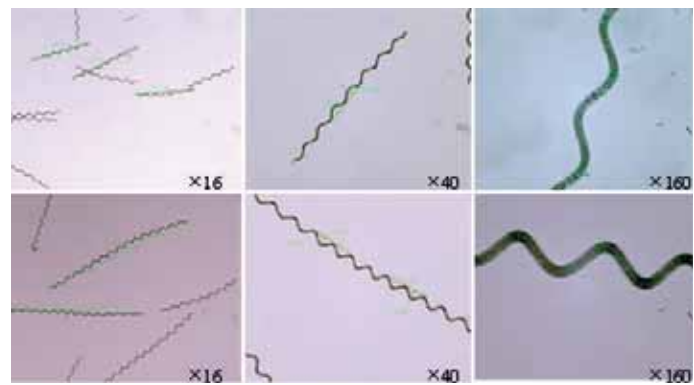

Figure 3 Microstructure of ST-6 (upper row) and PNK-2(lower row)

Biochemical character of PNK-2

The nutrients of the same batch of spirulina powder were analyzed by the authoritative institution (**Table 4**). The protein content in PNK-2 was 69.57% and increased by 8.31% than ST-6. The contents of chlorophyll, β-Carotene and phycocyanin in PNK-2 were 1.01%, 0.16% and 14.70%, respectively, having increased respectively by 8.60%, 6.67% and 6.68% compared to ST-6. Conversely, the γ-linolenic acid content of PNK-2 was 0.63%, i.e. reduced by 3.08% compared to the original strain.

Table 4. Comparison of nutrition contents between PNK-2 and ST-6

Species	Protein	Chlorophyll	β-carotene	Phycocyanin	γ-linolenic acid
ST-6	64.23%	0.93%	0.15%	13.78%	0.65%
PNK-2	69.57%	1.01%	0.16%	14.70%	0.63%

Discussion

Arthrospira platensis underwent great changes under the integrative effect of the space environment. The productivity of PNK-2, which was selected from the mutants, was increased by 22.89%. Yield of large-scale production increased by over 20%. The contents of protein, chlorophyll, β -Carotene and phycocyanin in PNK-2 were greatly increased. The protein content in particular reached 69.57% in PNK-2. All suggested that PNK-2 was a good quality and high-yielding *A. platensis* species, and could be retained for large-scale production.

BIBLIOGRAPHY

- Dillon, J.C., Phuc, A.P., Dubacq, J.P. Nutritional value of the alga *Spirulina*. *World Rev Nutr Diet* **77**, 32-46 (1995).
- Miranda, M.S., Cintra, R.G., Barros, S.B. *et al.* Antioxidant activity of the microalga *Spirulina maxima*. *Braz J Med Biol Res* **31**, 1075-79 (1998).
- Ayehunie, S., Belay, A., Baba, T.W. *et al.* Inhibition of HIV-1 replication by an aqueous extract of *Spirulina platensis* (*Arthrospira platensis*). *J Acquir Immune Defic Syndr Hum Retrovirol* **18**, 7-12 (1998).
- Mishima, T., Murata, J., Toyoshima, M. *et al.* Inhibition of tumor invasion and metastasis by calcium spirulan (Ca-SP), a novel sulfated polysaccharide derived from a blue-green alga, *Spirulina platensis*. *Clin Exp Metastasis* **16**, 541-50 (1998).
- Chen, F., Zhang, Q. Inhibitive effects of *spirulina* on aberrant crypts in colon induced by dimethylhydrazine. *Chung Hua Yu Fang I Hsueh Tsa Chih* **29**, 13-17 (1995) [in Chinese].
- Kim, H.M., Lee, E.H., Cho, H.H. *et al.* Inhibitory effect of mast cell-mediated immediate-type allergic reactions in rats by *spirulina*. *Biochem Pharmacol* **55**, 1071-76 (1998).
- Yang, H.N., Lee, E.H., Kim, H.M. *Spirulina* inhibits anaphylactic reaction. *Life Sci* **61**, 1237-44 (1997).
- Qureshi, M.A., Garlich, J.D., Kidd, M.T. Dietary *Spirulina platensis* enhances humoral and cell-mediated immune functions in chickens. *Immunopharmacol Immunotoxicol* **18**, 465-76 (1996).
- Torres-Duran, P.V., Miranda-Zamora, R., Paredes-Carbajal, M.C. *et al.* *Spirulina maxima* prevents induction of fatty liver by carbon tetrachloride in the rat. *Biochem Mol Biol Int* **44**, 787-93 (1998).
- Paredes-Carbajal, M.C., Torres-Duran, P.V., Diaz-Zagoya, J.C. *et al.* Effects of dietary *Spirulina maxima* on endothelium dependent vasomotor responses of rat aortic rings. *Life Sci* **61**(15), 211-19 (1997).
- Gonzalez, De Rivera C., Miranda-Zamora, R., Diaz-Zagoya, J.C. *et al.* Preventive effect of *Spirulina maxima* on the fatty liver induced by a fructose-rich diet in the rat, a preliminary report. *Life Sci* **53**, 57-61 (1993).
- Hu, H.J. Principle of *Spirulina* biology and biotechnology. Peking: Science & Technology Press, 2003.
- Voshak, A. Strain selection of *Spirulina* suitable for mass production. *Hydrobiologia* **151/152**, 75-77 (1987).
- Gong, X.M., Hu, H.J. Research of ^{60}Co -Gamma ray induces *A. platensis*. *Journal of Wuhan Botanical Research* **14**(1), 58-66 (1996).
- Wen, X.F., Liu, L.X. Progress of agriculture space induced breeding. *High-Technology & Industrialization* **6**, 31-34 (2001).
- Chen, J.X., Wang, X.F. Guide for botanical physiology experiment. Guangzhou: South China University of Technology Press, 2002.
- Lu, Y.M., Lai, Z.Y., Xiang, W.Z. Factory farming of *Spirulina*: critical factors affected quantity and quality. *Journal of Wuhan Institute of Chemical Technology* **23**(3), 11-14 (2001).

Improvement of Taro (*Colocasia esculenta* var *esculenta*) Through *In Vitro* Mutagenesis

S Seetohul, V Maunkee* & M Gungadurdoss

Abstract

An *in vitro* mutation programme was implemented to improve taro (*Colocasia esculenta* (L.) Schott) for resistance to the fungus *Phytophthora colocasiae*. Apical shoot tips used as explants were cultured on Murashige and Skoog medium (1962) with varying concentrations of Indole-3-acetic acid, Thidiazuron (1-Phenyl-3-(1,2,3-thiadiazol-5-yl) urea (TDZ) and N6-benzylaminopurine (BA). Optimal culture initiation and multiplication was obtained on MS supplemented with 10 mgL⁻¹ of IAA and 0.9 mgL⁻¹ TDZ/BA at 20 mgL⁻¹, respectively. Explants were exposed to various doses of gamma radiation and the effective mutation dose that causes 30% reduction in growth (LD₃₀) was found to be 7.65 grays. Nine accessions of *Colocasia* species (dasheen and eddoes type) and two from *Xanthosoma* species were used for morphological and molecular characterization. 44 morphological characters were assessed and analysed with an unweighed pair group method using an arithmetic average (UPGMA). For RAPD analysis, eight 10-mer random primers were selected as they amplified more than five polymorphic bands. UPGMA cluster analysis using Nei and Li's distance coefficient were then performed. Both morphological and molecular analysis revealed low genetic diversity among germplasm accessions. RAPD primers screened will be useful for characterization of mutant lines showing resistance to leaf blight while the micropropagation methodology developed will be useful for rapid multiplication of mutants.

Introduction

Taro (*Colocasia esculenta* (L.) Schott), which is considered to have originated in South East Asia [1] [2], is the most important edible member of the aroid family (*Araceae*). In Mauritius it is a highly appreciated commodity. However, its production has dropped drastically from 480 tons in 1995 to about 40-50 tons in 2003 due to severe attacks caused by the fungus *Phytophthora colocasiae*. *Phytophthora* leaf blight disease, which is known as the most destructive disease of taro and was identified for the first time in Mauritius in 1995, affected all local taro germplasm. Taro is a vegetatively propagated crop, which limits genetic variation within the species, and local quarantine regulations prohibit introduction of new resistant germplasm. Hence, an *in vitro* mutation breeding programme was implemented to develop mutant lines showing resistance to *Phytophthora colocasiae*.

This study focuses on the development of modern *in vitro* culture and molecular techniques to accelerate the improvement of taro for increased disease resistance.

Materials and Methods

In vitro mutagenesis of taro

In vitro initiation and multiplication media test

Explants were taken from axillary buds of developing suckers of taro. These were cleaned and rinsed with running tap water for one hour and

washed in a solution of benomyl (Benlate 50WP, 0.06%) for 15 minutes. They were then dipped in sodium hypochlorite (2%) for 15 minutes. Explants were established on Murashige and Skoog [3] medium with different concentrations of Indole-3-acetic acid (IAA) (0, 10, 15, 20 and 25 mgL⁻¹) for culture initiation. For multiplication, media based on MS medium with Thidiazuron (1-Phenyl-3-(1,2,3-thiadiazol-5-yl) urea (TDZ) at 0, 0.3, 0.6, 0.9, 1.0 and 1.2 mgL⁻¹ and N6-benzylaminopurine (BA) at 0, 1, 2, 3 and 4 mgL⁻¹ were tested. All media were solidified with Phytigel (0.18%) and had a pH adjusted to 5.7±0.1 before autoclaving for 15 min at 121°C. Explants were cultured at 23±2°C under 12-hour photoperiod.

Determination of effective mutation dose (LD₃₀)

Thirty apical shoot-tips of 3-4mm, excised from tissue culture plantlets, were irradiated with 2, 4, 6, 8, 10, 12, 14, 16, 20, 40 and 60GY. The control consisted of non-irradiated shoot tips. Explants were cultured on MS media with IAA (10mgL⁻¹). Data on percentage survival, number of leaves and roots, length of leaves and roots and number of buds was recorded weekly for eight weeks.

Determination of optimal hardening substrate for taro plantlets

Ten treatments of various combinations of composted scum, flyash, bagasse, vermiculite and peat were tested against control, imported substrates, which consisted of a mixture of lecca, peat and vermiculite in the ratio of 2:5:1. Each treatment consisted of three trays with 50 tissue-cultured plantlets per tray. Data on percentage mortality, number and length of leaves and root length was taken after 30 days.

Morphological and molecular studies of taro germplasm

Survey and Germplasm collection

Germplasm collection activities were undertaken from various parts of the country. Detailed data on place of collection, sample type, type of vegetation, habitat/ecology for collected germplasm accessions as shown in **Table 1** was recorded. From each location, random samples of plants were collected to constitute the population sample.

Table 1. Germplasm used for characterization

Colocasia esculenta spp		Xanthosoma spp	
Dasheen type		Eddoes	
Arouille violette – giant (Avg.)	Songe Blanc (Sb)	Arouille carri – Marron (Acm)	Arouille Popette-Blanc (Apb)
Arouille violette – dwarf (Avd)	Songe Noire (Sn)	Arouille carri – vert (Acv)	Arouille Popette-marron (SI)
	Songe Réunion (Sr)	Arouille carri – blanc (Acb)	
	Songe wild type (Wt)		

Morphological characterization

Morphological traits and taxonomical values in taro

The collected germplasm accessions, including *Colocasia esculenta* (*Dasheen and Eddoes* type) and two accessions from the *Xanthosoma* species were included in this study. The original collections were first multiplied and then grown at Reduit Crop Research station. All the accessions were grown in replicated trial (three replicates in randomized block design) following optimum agronomic practices. Forty-four morphological traits were described and quantified according to the IPGRI 1999, descriptors for taro (*Colocasia esculenta* var. *esculenta*). Data was recorded on five randomly selected plants per accession.

Molecular Characterization of collected germplasm

DNA extraction and quantification

Total genomic DNA was extracted from young rolled leaves of taro following the cetyl trimethylammonium bromide (CTAB) method [4] with modifications. The DNA concentration (after RNase treatment and phenol chloroform extraction) was quantified using a UV spectrophotometer.

RAPD analysis of taro germplasm

A series of optimization experiments was conducted where concentrations of template DNA, primers and MgCl₂ were varied to determine which conditions gave the strongest and most reproducible patterns. The optimized PCR reaction mixture (30ml) consisted of 40ng DNA, 1 x PCR buffer, 4mM MgCl₂, 200 μM dNTP mix of dATP, dTTP, dCTP, and dGTP, 0.2μM primer and 1U *Taq Polymerase* (Bioline, USA). PCR amplification was performed in a PTC-100 programmable thermal cycler, programmed to pre-denature DNA for 5 min at 94°C, denature DNA at 94°C for 1 min, anneal DNA to primers at 35°C for 1 min and polymerize DNA for 2 mins at 72°C. After 45 cycles, the programme allowed a final extension of 5 min at 72°C before maintaining at 4°C. Following amplification, RAPD products (10μl) were loaded in 1.5% agarose gels in TBE buffer (Tris /Borate /EDTA), separated by electrophoresis at 90-100 V for about 2½ hours, and photographed on a UV transilluminator. The size of amplification products was determined by comparison with Hyperladder II.

Initially, 62 random decamer primers from commercially available primer series (Inquaba Technology) were screened using the DNA from four accessions.

Data Analysis

In this study, pair-wise comparisons of taro genotypes, based on the presence or absence of unique and shared fragments produced by RAPD amplifications, were used to generate similarity matrices based on Nei and Li's [5] definition of similarity which is as follows:

$$S_{ij} = 2a / (2a + b + c)$$

where S_{ij} is the similarity between two individuals i and j , a is the number of bands present in both i and j , b is the number of bands present in i and absent in j , and c is the number of bands present in j and absent in i ; and this also known as the Dice coefficient.

The similarity matrix was then analyzed using UPGMA clustering methods. Analyses were performed using the software "Population." (CNRS; <http://www.cnrs-gif.fr/pge>).

Results and Discussion

In vitro mutagenesis studies of taro

In vitro initiation and multiplication media test for taro

In initiation media, healthier and more vigorous growth in terms of

highest average number of leaves and roots was obtained with IAA at 10 mg L⁻¹ (Fig. 1). There were significant differences at a 5% level in number of leaves between the different IAA concentrations. MS media with beyond 15mg L⁻¹ IAA did not support growth of taro explants compared to hormone-free MS medium, where growth may be attributed to the effect of endogenous growth regulators. Similar observations regarding the role of endogenous growth regulators in determining the shoot forming capacity of leaf disks have been reported in tomato [6, 7]. Another study [8] has also demonstrated that a critical endogenous level of growth regulators has to be attained before cell division and organogenesis can occur.

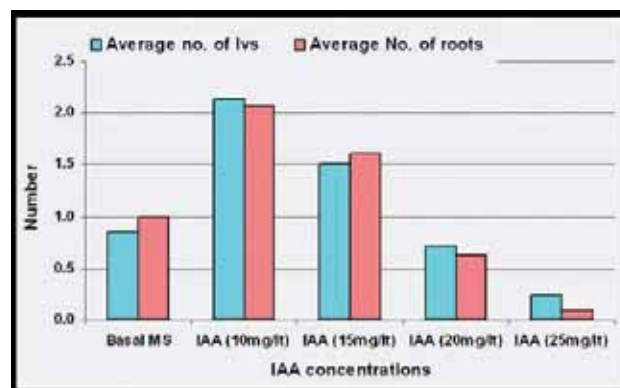

Figure 1 Effect of different concentrations of IAA on *in vitro* initiation of taro at eight weeks.

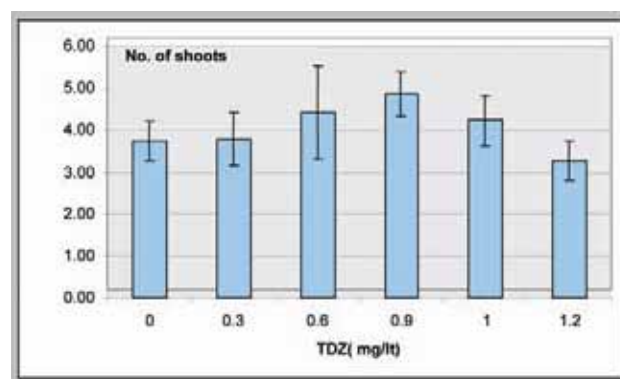

Figure 2 Effect of different concentrations of TDZ on *in vitro* multiplication of taro at eight weeks.

Determination of effective mutation dose (LD₃₀)

Among all the parameters studied, number of leaves was considered in determining LD₃₀ because it resulted in the least experimental error. The average number of leaves after 18 days, of shoot-tips treated with 2Gy was greatest, even more than that of the control, indicating the boosting effect of this dose (Fig. 3). A similar response was obtained when *Anthurium Andreanum in vitro* leaf explants were irradiated with 5Gy. The calli and seeds also expressed better responses at the 5Gy, but lethality at 15Gy [9]. In this study, irradiation doses above 20Gy were lethal to taro explants. Effective mutation dose is controlled by a number of parameters including the genotype, the type of explant, the orientation of explant on the culture medium, and the origin of the explant from the mother plant [10]. Data recorded on the number of leaves showed that the effective mutation dose, which caused a 30% reduction in growth, was 7.65Gy as shown in Fig. 4.

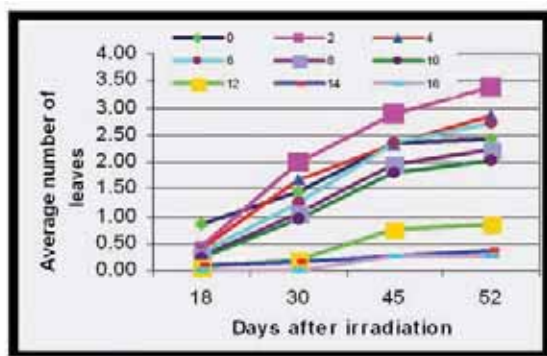
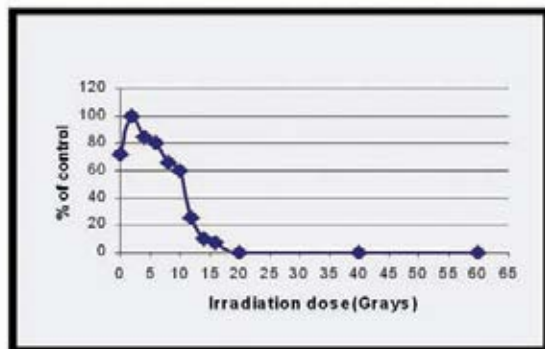

Figure 3 Response of *in vitro* culture of shoot tips of taro after irradiation.



Days after irradiation	LD30(Gy)
30	6.50
45	8.45
52	8.00
Average	7.65

Figure 4 Effective mutation dose which caused 30% reduction in growth.

Determination of optimal hardening substrate for taro plantlets

Almost no mortality was recorded in three treatments, viz. 50% scum + 50% bagasse, 70% Scum + 30% bagasse, and 100% peat. The number of leaves per plant ranged from three to five for all treatments. However, the highest growth of leaves in terms of length four weeks after hardening was recorded with 60% scum + 40% fly ash (13.60cm), and with 50% vermiculite + 50% peat (13.63cm). Vermiculite and peat being very expensive, the locally available substrate 60% scums + 40% fly ash from sugar cane industry was selected for hardening of *in vitro* taro plantlets.

Morphological characterization of taro germplasm

The UPGMA tree based on morphological traits is shown in Fig 6. Morphological observation showed that the Dasheen type could be distinguished from Eddoes by the presence of a main corm, stolons and absence of suckers, while Eddoes are characterized by a presence of cormels and suckers. However, it was difficult to distinguish between the two dasheen types “Songe” (*Sb* and *Wt*) and “Arouille” (*Avg* and *Avd*). Pair-wise genetic distances based on morphological traits for the 11 taro genotypes, ranged from 0.22-0.83. The dendrogram indicates that the majority of taro genotypes were clustered in three groups. As expected, both AP and SI, belonging to the *Xanthosoma species*, are clustered together, distantly apart from others. The Eddoes type (*Colocasia esculenta* var. *antiquorum*) namely *Acv*, *Acb* and *Acm* were separated in another group.

RAPD Analysis of taro germplasm

Table 2 lists the eight primers selected as useful for RAPD markers of taro based on their ability to generate complex and scorable amplifica-

tion patterns. Figure 8.0 shows the RAPD banding profile obtained with primer ONP 07. A total of 91 RAPD bands ranging from 200bp to 3.5Kbp were obtained, of which 95.7% were polymorphic with an average of 11 bands per primer. Pair-wise genetic distance based on RAPD data for the 11 taro genotypes ranged from 0.12 to 0.56 indicating low diversity. The analysis method UPGMA was used to provide detail insights into the genetic relationships (Fig. 7).

Table 2. Most informative RAPD primers, total number of bands, number of polymorphic bands and proportion of polymorphic bands

Primer	Sequence	Total No. of amplicons	No. of polymorphic bands	% Polymorphism	Fragment size (bp)
OPO 03	CTGTTGCTAC	10	10	100	500-1750
ONP 07	CAGCCAGAG	16	16	100	750-2750
OPC 16	CACACTCCAG	8	8	100	500-1400
OPA 17	GACCGCTTGT	15	14	93	350-2000
OPC 08	TGGACCGGTG	8	8	100	400-1000
OPP 16	CCAAGCTGCC	14	13	92.8	1250-3500
OPO 19	GGTGCACGTT	11	10	91	800-1400
OPO 07	CAGCACTGAC	9	8	88.8	200-1000



Figure 6 UPGMA dendrogram based on 44 morphological data.

Figure 7 UPGMA dendrogram on 11 taro genotypes based on RAPD data. Numbers represent percent bootstrap support for each node.

Based on RAPD data, the taro germplasm has been classified in three groups, with *SI* as an out-group. *SI*, which is also known as “Arouille Popette marron” together with *AP* (Arouille popette blanc), belong to the *Xanthosoma spp.* The three types of “Arouille carri” (*Acm*, *Acv*, *Acb*) were grouped together. This is expected as they form part of the eddoes type of *Colocasia esculenta*, var *antiquorum* (triploid), as compared to *Avd* and *Avg*, which belong to the variety *esculenta* (diploid), *SR*, believed to be introduced in Mauritius from Reunion Island was found closely related to *SN* (songe noire), hence grouped together, while songe “wild type” *Wt* is more related to *SB* (songe blanc) within the group. Resistance to *Phytophthora* leaf blight disease caused by *Phytophthora colocasiae* is observed in *Wt*, *SR*, *SI* and *AP*.

Analysis of morphological and RAPD markers to assess diversity. The dendrograms obtained from both morphological markers and genetic variations indicate that the majority of the 11 taro genotypes

were clustered in three groups, with low genetic diversity. Studies carried out by [11] revealed high genetic diversity among Indonesian germplasm and were able to distinguish between Hawaiian accessions by using RAPD markers. The low genetic diversity of our local germplasm can be explained by the fact that taro in Mauritius is propagated mainly by vegetative means, and although it bears flowers, these are sterile.

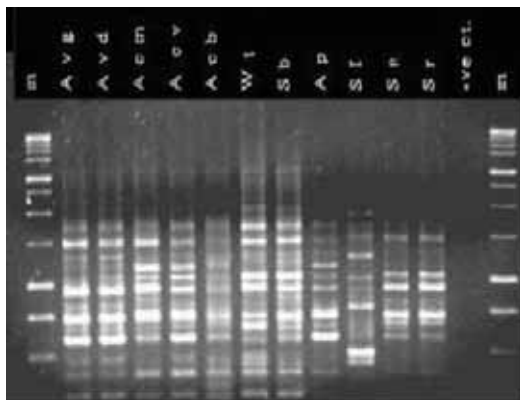

Figure 8 RAPD profile obtained with primer ONP 07. Lanes 1-11 accessions of taro (nine *Colocasia esculenta* spp. & 2 *Xanthosoma* spp) spp. Lane m: DNA size marker. A total of 16 amplified products ranging from 750 -2750 bp were produced. A unique fragment of 1000 bp was obtained with *SI*, differentiating this genotype from the rest of the group. Similar fingerprints were obtained with *Avd* and *Avg* and a common band of 2,500 bp is shared among *Acm*, *Acv* and *AP*. 1: **A.Violette (giant)**; 2: **A.Violette (dwarf)**; 3: **A.Carri marron**; 4: **A.carri verte**; 5: **A.Carri blanc**; 6: **Wild type**; 7: **Songe Blanc**; 8: **Arouille Popette blanc**; 9: **Arouille Popette Marron**; 10: **Songe Noire**; 11: **Songe Reunion**; 12: **Negative control**.

In the dendrogram based on RAPD data, *AP* and *SI* belonging to *Xanthosoma* spp, although branched out from the *colocasia* spp, were found to be related to the Dasheen Type (*Avd* and *Avg*) of this species. However, based on morphological traits, *AP* and *SI* although separated from others were closely related with the Eddoes type (*Acv*, *Acb*, *Acm*). This inconsistency in both RAPD and morphological analysis can be explained by several factors. The genetic origin of each RAPD marker is different, while morphological expression (phenotype) is conditioned by the state of the plant, by agricultural management and by the environmental conditions in which it develops. On the other hand, it is possible that the dominant nature of RAPD markers and RAPD technique can be limited to detecting polymorphism in cases of heterozygosity [12]. In such cases, only variables with strong genetic control should be quantified in morphological trait analysis, and other more effective molecular markers such as AFLP, SSR or ISSR should be used to obtain more precise taxonomic clusters within taro genotypes of low genetic diversity.

Conclusion

In this study the optimal initiation, multiplication and hardening media, along with the effective mutation dose were determined for taro. Such micropropagation methodology will be very useful for the rapid multiplication of promising mutant lines developed. The RAPD primers already identified for taro will be very useful for characterizing taro mutant germplasm showing resistance to Taro Leaf Blight disease, caused by *Phytophthora colocasiae*. Furthermore, these primers will also be very useful for future genetic analysis and provide taro breeders with a genetic basis for selection of parents with disease resistance in other crop improvement programmes.

ACKNOWLEDGEMENTS

The authors wish to thank IAEA for partly funding the project, FARC for providing tissue-culture facilities for implementing the project, Assistant Research Scientists of the Agronomy Division, the Management

of Agricultural Research and Extension Unit and the University of Mauritius for support in this study.

BIBLIOGRAPHY

1. Trujillo, E. E. Diseases of the genus *Colocasia* in the Pacific area and their control, Tropical Root crops (Proc. Symp.1967) Vol. 2 (Tai, E. A., Charles, W.B., Haynes, P. H., Iton, E.F. Leslie, K.A., Ed.), University of West Indies 13-18 (1967).
2. Zhang, K.M. *et al.* Isolates of *Phytophthora colocasiae* from Hainan Island in China, evidence suggesting an Asian origin of this species. *Mycologia* **86** 108-112 (1994).
3. Murashige, T., Skoog F. A revised medium for rapid growth and bio-assays with tobacco tissue cultures. *Physiol. Plant.* **15** 508-509 (1962).
4. Doyle, J.J, Doyle, J.L. A rapid DNA isolation procedure for small quantities of fresh leaf tissue. *Phytochemistry bulletin* **19**, 11-15 (1987).
5. Nei M., Li W.H. Mathematical model for studying genetic variation in terms of restriction endonucleases. *Proc. Natl. Acad. Sci.* **76** 5269-5273 (1979).
6. Kartha, K.K. *et al.* Morphogenic investigations on *in vitro* leaf culture of tomato (*Lycopersicon esculentum* Mill. cv. Starfire) and high frequency plant regeneration. *Z. Pflanzenphysiol.* **77** 292-301 (1976).
7. RANKENBERGER, E. *et al.* Diallel analysis of shoot-forming capacity among selected tomato genotypes. *Z. Pflanzenphysiol.* **102**, 233-242 (1981).
8. Pilet, E. Effect on Root Growth of Endogenous and Applied IAA and AB. *American Society of Plant Biologist* **83**(1), 33-38 (1987).
9. Puchoa D. *In vitro* mutation breeding of *anthurium* by gamma radiation, *International Journal of Agriculture and Biology* **7**(1), 11-20 (2005).
10. Douglas, G.C. Effects of gamma radiation on morphogenesis and mutagenesis in cultured stem explants of Poplar, Nuclear Techniques and *In vitro* Culture for Plant Improvement. (Proc.of a Symposium, IAEA, Vienna), 23-31 (1985).
11. Irwin, S.V. *et al.* Molecular characterisation of taro (*Colocasia esculenta*) using RAPD markers. *Euphytica* **99**, 183-189 (1998).
12. Parker, G.D., Chalmers, K.J., Rathjen, A.J., Langridge, P. Mapping loci associated with flour color in wheat (*Triticum aestivum* L.) *Theor Appl Genet* **97**, 238-245 (1998).

Role of Classical Mutagenesis for Development of New Ornamental Varieties

S K Datta

Abstract

Mutation techniques by using ionizing radiations and other mutagens have successfully produced and commercialized a large number of new promising varieties in different crops including ornamental plants worldwide. Considering the importance of induced mutagenesis, extensive work on classical mutagenesis has been carried out by the author, who has successfully developed 76 new mutant varieties using gamma radiation in different ornamentals. Research carried out generated voluminous literature on radio-sensitivity, selection of materials, methods of exposure to gamma-rays, suitable dose, detection of mutations, isolation of mutants and commercial exploitation of mutants. Different treatment methodologies such as recurrent irradiation, colchicine treatment, and mutation frequency and spectrum, have been precisely determined for successful development of new varieties. Changed flower type, development of appendage like structure on florets, striped flowers and induction of tubular florets are a few of the interesting observations in chrysanthemum. Development of late blooming varieties in chrysanthemum has tremendous commercial impact. Studies have clearly proved that classical mutagenesis can be exploited for the creation of new and novel ornamental varieties of commercial importance.

Introduction

As a result of science-based techniques and steady supply of improved plant materials floriculture has become a very important industry in many countries. The possibilities of creating different forms and improving ornamentals are infinite and a breeder will always have goals to work towards. Mutation is recognized as one of the most important technologies for the development of new varieties through genetic manipulation. Mutation techniques by using ionizing radiations and other mutagens have successfully produced a large number of new promising varieties in different ornamental plants. It will not be possible to consider all the scientific papers published in the field of application of mutagenesis for improvement of ornamental plants due to limitations of space. The details of utilization of induced mutations and its prospects and released mutant varieties have been reported [1-6]. The present paper will cover most of the basic information generated by the author during his practical work at National Botanical Research Institute (NBRI), Lucknow, India, for the successful application of classical induced mutagenesis for improvement of different ornamental crops. While describing the work carried out by the author on bougainvillea, chrysanthemum, hibiscus, gladiolus, perennial *portulaca*, *Polianthes tuberosa*, rose, *Lantana depressa* etc., attempts will also be made to incorporate important results obtained by other workers for improvement of ornamental plants.

4/184, Vivek Khand, Gomti Nagar, Lucknow 226010, India [Retired Deputy Director and Head, Floriculture Section, National Botanical Research Institute, Lucknow; India]

Present address : CSIR, Emeritus Scientist, Madhyamgram Experimental Farm, Acharya J. C. Bose Biotechnology Innovation Center, Bose Institute, Jessore Road, Madhyamgram, 24-Parganas (N), Kolkata 700129, India.

E-mail : subodhskdatta@rediffmail.com; subodhskdatta@yahoo.com

Materials and Methods

Plant materials

For practical experiments different ornamentals like bougainvillea (80 cvs.), chrysanthemum (150 cvs.), gladiolus (8 cvs.), *Hibiscus rosa-sinensis* cv. Alipur Beauty, perennial *portulaca*, *Polianthus tuberosa* (3 cvs.), rose (50 cvs.), *Lantana depressa* etc. were selected as materials.

Treatment methodology

Suitable propagules of above mentioned ornamentals were treated with different doses of Gamma-rays (cobalt 60 radiation source) as follows :

Ornamental plant	Propagule	Dose
Bougainvillea	Stem cuttings	250– 250 rads
Chrysanthemum	Rooted cuttings/suckers	1.0-3.5 krad
Gladiolus	Bulb	250 rads–5 krad
Hibiscus	Stem cuttings	1.0–4 krad
Perennial <i>portulaca</i>	Stem cuttings	250–1250 rads
<i>Polianthus tuberosa</i>	Bulb	250 rad–8 krad
Rose	Stem with budding eyes	2–6 krad
<i>Lantana depressa</i>	Stem cutting	1–4 krad

Recurrent irradiation

Recurrent irradiation experiments were carried out on chrysanthemum cv. 'Sharad Bahar' and rose cv. 'Contempo' as per experimental design mentioned earlier [7-8].

Colchicine treatment

Budwoods of rose cv. 'Contempo' and rooted cuttings of chrysanthemum cv. 'Sharad Bahar' were dipped in 0.0625 and 0.125% aqueous solution of colchicine for 4 and 5 hrs., respectively. Treated materials were washed thoroughly and planted in bed following all cultural practices [9-10].

Treatment of mutant genotypes

Gamma-ray induced mutant genotypes of chrysanthemum were treated with different doses of Gamma-rays for further improvement.

Results

Radiosensitivity and suitable mutagen dose (LD₅₀ dose), a prerequisite for large-scale irradiation for induction of mutations of all experimental cultivars have been determined precisely [11-13]. Radiosensitivity has been estimated with respect to influence of various factors including flower type, shape and color, chromosome number, Interphase Chromosome Volume, Interphase Nuclear Volume and 2c DNA content after treatment with different doses of Gamma-rays. On the basis of these observations and available literature it has been very clear that radiosensitivity in different ornamentals is a genotype-dependent mechanism [14-15].

The frequency of mutation varied with the cultivar and dose of Gamma-rays. Some cultivars were moderately sensitive, some were more sensitive and some were resistant to mutagens. Like mutation frequency, the spectrum of mutation also varied with the cultivar and dose of Gamma-rays. NBRI has developed 76 new mutant varieties using gamma radiation in different ornamentals (5 bougainvillea, 6 perennial *portulaca*, 43 chrysanthemum, 1 *Hibiscus*, 16 rose, 2 tuberose, 3 *Lantana depressa*) [16]. The mutations concerned mainly flower color/shape and chlorophyll variegation in leaves. Thus, almost all the experimental colors could be mutated, including yellow color from white. More than one flower color mutation could also be induced in different cultivars. Phenotypic variation, including several interesting novel changes in flower form, have been recorded. Induction of tubular florets was one of the interesting observations in chrysanthemum [5].

Chlorophyll variegation in leaves provides additional beauty to plants not only at the time of blooming but also even when there is no flower. A wide range of variegated plants have been developed through mutagenic treatment in different ornamentals. A number of chlorophyll variegated mutants have been developed and released in Bougainvillea, Tuberose and *L. depressa* [17]. Some of the most promising and beautiful variegated mutants induced by gamma irradiation in bougainvillea are 'Arjun,' 'Pallavi,' 'Mahara Variegata,' 'Los Banos Variegata' and 'Los Banos Variegata Jayanthi' [18]. 'Rajat Rekha' and 'Swarna Rekha' are the most promising chlorophyll variegated mutants of single and double flower Tuberose respectively.

In most cases, chlorophyll variegation developed as a mericlinal chimera. For establishment of mericlinal chimeric branches into a new variety (as periclinal form), all green leaves of the mericlinal branch were removed to avoid diplontic selection and to provide better growth for the auxiliary buds of the variegated leaves. Ultimately, new branches developed from the auxiliary buds of the variegated leaves, which were either periclinal or mericlinal. For a mericlinal branch, the same process was repeated, while periclinal variegated branches were multiplied directly by cuttings for establishment of a new variety. This technique was standardized with *Lantana depressa* and bougainvillea to convert mericlinal chimera into periclinal chimera [19-20].

For the first time, colchicine has been used to develop new flower colors in chrysanthemum (21-23) and rose (24-26). Chrysanthemum cv 'Sharad Bahar' was purple, whereas the mutant ('Colchi Bahar') color was terracotta red. The original color of rose cv 'Contempo' was orange with yellow eye and the mutant colors were tangerine orange and empire yellow.

Recurrent irradiation experiments with chrysanthemum and rose resulted in more genetic variability. Percentage of mutations and spectrum of mutations was more in recurrent irradiated populations in both of these species. In chrysanthemum, two new flower colors were detected in the recurrent irradiated population. It is concluded that recurrent mutagen treatment may provide an even greater range of genetic variability than a single mutagen treatment in vegetatively propagated ornamentals. This method can be successfully used in routine mutagenesis programmes for inducing novelties in flower color and shape [7-8].

Somatic mutations in all the above mentioned plants were mostly detected in M_1V_1 . But mutations have also been detected in M_1V_2 , M_1V_3 and later vegetative generations from normal looking irradiated plants in M_1V_1 . It has been observed that the chances of getting solid mutants were higher in M_1V_2 and later generations. The mutated cells of the lower auxiliary buds remain in the dormant stage (M_1V_1) and express their mutant character when included during vegetative propagation in M_1V_2 [5].

Sensitivity of mutant genotypes of chrysanthemum was found to be the same as the original cultivars. A wide range of flower color mutants were obtained, not only largely including the outstanding characteristics of the original cultivars, but sometimes even with an appreciable improvement in quality and yield [27-30].

A major drawback of classical mutagenesis is the formation of chimeras. The concept of management of chimera and *in vitro* mutagenesis has opened new possibilities for inducing increased number of mutants and solid mutants in a relatively short period of time [31-33]. Extensive practical work has been carried out by the author and his team on management of chimera and *in vitro* mutagenesis which has been discussed in more detail in another paper elsewhere in this volume (number IAEA-CN-167-284P).

Discussion

The main advantage of mutation induction in vegetatively propagated crops is the ability to change one or a few characters of an otherwise outstanding cultivar without altering the remaining and often unique part of the genotype [1]. Mutation breeding has been most successful in ornamental plants due to some additional advantages. Changes in any phenotypic characteristics like color, shape or size of flower and chlorophyll variegation in leaves can be easily detected. The heterozygous nature of many of the cultivars offers high mutation frequency. Mutation techniques by using ionizing radiations and other mutagens have successfully produced a large number of new promising varieties in different ornamental plants. Voluminous literature has been published in induced mutagenesis. Different basic and applied aspects of induced mutagenesis on ornamental plants have been reported earlier [1, 4, 5, 15, 17, 34-36]. Radiation-induced phenotypic variation including several novel changes in flower form have been reported earlier – double flower type begonia [1], chrysanthemum [34], gladiolus [37], hibiscus [38], *Hyacinthus* [1], semi-double or single carnation [3, 40], increase and decrease in petal number in rose [1], variegated and dwarf mutant in *Coleus* [41], dwarf mutants in *Impatiens platypetala* [42], changed flower color in *Lilium* [1, 43], begonia [44], *Streptocarpus* [45], etc. Effects of fractionated doses and different basic aspects of radiation-induced changes have been studied in African violet [1].

Out of all presently available crop improvement techniques, it is very clear that induced mutation breeding is well standardized for the development of new ornamentals, whereas a molecular technique is in progress. Although mutation breeding is considered to be a random (chance) process, the possibility of inducing a desired flower color mutation has been proved in chrysanthemum. If white flower color varieties are irradiated, and if there is any mutation, the mutation will be yellow. Red varieties, on the other hand, will produce either a completely yellow mutation, or a mixture of red and yellow. If yellow varieties are irradiated, and if there is any mutation, the mutation will be either different shades of yellow or white or a mixture of yellow and white (46). The product of molecular breeding is expected to be as per desire, but it will take time to develop a reproducible regeneration and transformation system. Induced mutants are mostly stable. Flower color mutants induced 25 years ago are still maintaining purity at NBRI, Lucknow, India. There are numerous reports for the variation and instability of genes in transgenic plants. It has been reported that a gene can lose its transcriptional activity after crosses into the next generation or after the introduction of another foreign construct into such a transgenic line. Induced mutagenesis and mutant induction through the application of classical mutagenesis is a relatively easy-to-apply technology for production of novel varieties in ornamental breeding. At this stage, induced mutation breeding combined with *in vitro* chimera management has tremendous potential for developing new flower colors and shapes.

ACKNOWLEDGEMENTS

Thanks are due to the Director, NBRI, Lucknow, India for providing the facilities. Thanks are also due to the Director, Bose Institute, Kolkata and CSIR, New Delhi for present association of Dr. S. K. Datta with the institute as CSIR, Emeritus Scientist.

BIBLIOGRAPHY

1. Broertjes, C., Van Harten, A.M. Applied mutation breeding for vegetatively propagated crops, Elsevier, Amsterdam (1988).
2. Schum, A., Preil, W. Induced mutations in ornamental plants. In: Jain SM, Bras, Ahloowalia, B.S. (eds) Somaclonal variation and induced mutations in crop improvement (1998) 333-366, Kluwer Academic Publishers, Dordrecht, The Netherlands.
3. Micke, A. Induced mutations for crop improvement, *Gamma Field Symposium* **30**, 1-21 (1991).
4. Datta, S.K. Mutation studies on Garden Roses: A review. *Proc. Ind. Nat. Sci. Acad.* **B63**(1&2), 107-126 (1997).
5. Datta, S.K. Mutation studies on garden Chrysanthemum- a review. (ed. S.P. Singh) *Sci Hortic* **7**, 159-199, Scientific Publisher, Jodhpur (2001).
6. Ahloowalia, B.S. *et al.* Global impact of mutation-derived varieties, *Euphytica*.
7. Datta, S.K. Effects of recurrent gamma irradiation on rose cv. 'Contempo'. *J. Nuclear Agric. Biol.* **15**(2), 125-127 (1986).
8. Datta, S.K. Evaluation of recurrent irradiation on vegetatively propagated ornamental: Chrysanthemum. *J. Nuclear Agric. Biol.* **20**(2), 81-86 (1991).
9. Gupta, M.N., Datta, S.K. Effects of colchicines on rose cultivar 'Contempo'. *Indian Rose Annual* **3**, 51-54 (1984).
10. Datta, S.K., Gupta, M.N. Colchicine induced somatic flower color mutation in chrysanthemum, Bangladesh. *J. Bot.* **16**(1), 107-108 (1987).
11. Datta, S.K. Radiosensitivity of garden roses. *J. Nuclear Agric. Biol.* **14**, 133-135.
12. Datta, S.K. Radiosensitivity of garden chrysanthemum. *J. Indian Bot. Soc.* **71**, 283-284 (1992).
13. Banerji, B.K., Datta, S.K. Varietal differences in radio sensitivity of garden chrysanthemum. *The Nucleus* **36**(3), 114-117 (1993).
14. Datta, S.K., Banerji, B.K. Analysis of induced somatic mutations in chrysanthemum. *J. Ind. Bot. Soc.* **71**(I-IV), 59-62 (1991).
15. Datta, S.K. Induction and analysis of somatic mutations in vegetatively propagated ornamental. D. Sc. Thesis, Kanpur University, Kanpur, India (1992).
16. Datta, S.K. Improvement of ornamental plants through induced mutation, Recent advances in genetics and cytogenetics (Farook, S.A., Khan, I.A., eds), Premier Publishing House, Hyderabad, 215-228 (1989).
17. Datta, S.K. Ornamental plants- Role of mutation. Daya Publishing House, Delhi, p. 219 (1997).
18. Datta, S.K. Bougainvillea research at National Botanical Research Institute, Lucknow, *J. Ornament Hort.* **7**(1), 1-14 (2004).
19. Banerji, B.K. *et al.* Mutation breeding in double bracted Bougainvillea cv. "Roseville's Delight". *J. Nuclear Agric. Biol.* **16**(1), 48-50 (1987).
20. Datta, S.K. Induced mutation for plant domestication : Lantana depressa. *Proc. Indian. Sci. Acad.* **B61**(1), 73-78 (1995).
21. Datta, S.K. 'Colchi Bahar'- A new chrysanthemum cultivar evolved by colchi-mutation. The Chrysanthemum. **43**(1), 40 (1987).
22. Datta, S.K. Gupta, M.N., Effects of colchicines on rooted cuttings of Chrysanthemum. The Chrysanthemum. **40**(5), 191-194 (1984).
23. Datta, S.K., Gupta, M.N., Colchicine induced somatic flower color mutation in Chrysanthemum. Bangladesh *J. Bot.* **16**(1), 107-108 (1987).
24. Gupta, M.N., Datta, S.K. Effects of colchicine on rose cv. 'Contempo'. *Indian Rose Annual.* **3**, 51-54 (1983).
25. Datta, S.K., Gupta, M.N. Treatment of budding eyes with colchicines for induction of somatic mutations in rose. *Indian Rose Annual* **4**, 80-83 (1985).
26. Datta, S.K. Colchicine induced mutations in seed and vegetatively propagated plants. *J. Indian Bot. Soc.* **69**, 261-266 (1990).
27. Datta, S.K. Gamma ray induced mutant of a mutant of chrysanthemum. *J. Nuclear Agric. Biol.* **14**, 131-133 (1985).
28. Datta, S.K., Effects of gamma irradiation on mutant genotypes: *Chrysanthemum cultivar 'D-5'* and its mutants. *J. Indian Bot. Soc.* **75**(1-2), 133-134 (1996).
29. Datta, S.K., Shukla, R. Effects of gamma irradiation on mutants of Tuberose (*Polyanthes tuberosa*). *Herbertia* **59**, 139-141 (1996).
30. Broertjes, C. *et al.* A mutant of a irradiation of progressive radiation induced mutants in a mutation breeding programme with *Chrysanthemum morifolium* Ram. *Euphytica* **29**, 525-530 (1980).
31. Ahloowalia, B.S. *In vitro* mutagenesis for the improvement of vegetatively propagated plants. In: Induced Mutations and Molecular Techniques for Crop Improvement. Proc IAEA/FAO Symp, Vienna 19-23 June 531-541 (1995).
32. Maliga, P. Isolation and characterization of mutants in plant cell cultures. *Ann Rev Plant Physiol* **35**, 519-552 (1984).
33. Maluszynski, M. *et al.* Application of in vivo and in vitro mutation techniques for crop improvement. *Euphytica* **85**, 303-315 (1995).
34. Datta, S.K. *Chrysanthemum cultivars* evolved by induced mutations at National Botanical Research Institute, Lucknow. *The Chrysanthemum* **44**(1), 72-75 (1988).
35. Datta, S.K. Some basic informations for induction of somatic mutations in vegetatively propagated ornamentals. *Adv Hortic For* **1**(33), 261-265 (1990).
36. Datta, S.K. Induction and analysis of somatic mutations in garden chrysanthemum. *Adv Hortic For* **1**(31), 241-254 (1990).
37. Lysikov, V.N. Experimental mutagens in plants. *Izvestiya Akademii Nauk Moldavskoi SSR Biologicheskije I Khimicheskije Nauki* **4**, 3-10 (1990).
38. Banerji, B.K., Datta, S.K. 'Anjali' - A new gamma ray induced single flower mutant of Hibiscus. *J. Nuclear Agric. Biol.* **17**(2), 113-114 (1986).
39. Simard, M.H.N. *et al.* Variants of Carnation (*Dianthus caryophyllus*) obtained by organogenesis from irradiated petals. *Plant Cell Tiss Organ Cult* **29**, 37-42 (1992).
40. Cassels, A.C. *et al.* Diplontic selection as a positive factor in determining the fitness of mutants of *Dianthus 'Mystere'* derived from x-irradiation of nodes *in vitro* culture, *Euphytica* **70**, 167-174 (1993).
41. Love, J.E., Malone, B.B. Anthocyanin pigments in mutant and non-mutant *Coleus* plants. *Rad. Bot.* **7**, 549-552 (1967).
42. Weigle, J.L., Butler, J.K. Induced dwarf mutant in *Impatiens platypetala*. *J. Heredity* **74**, 200 (1983).
43. Matsubara, H. Mutation breeding in ornamental plants. Techniques used for radiation induced mutants in Begonia, Chrysanthemum, Abelia and Winter Queen. *Agric Hortic* **50**, 811-812 (1975).
44. Doorenbos, J., Karper, J.J. X-ray induced mutants in Begonia x hiemallia. *Euphytica* **24**, 13-19 (1975).
45. Davis, D.R., Hedley, C.L. The induction of mutation of all-year round flowering in *Streptocarpus*. *Euphytica* **24**, 269-275 (1975).
46. Datta, S.K., Role of mutation breeding in inducing desired genetic diversity in ornamentals for the floriculture trade. Proc. Symp. Induced Mutations and Molecular Techniques for Crop Improvement, FAO/IAEA, 19-23 June 670-672 (1995).

Management of Chimera and *In Vitro* Mutagenesis for Development of New Flower Color/Shape and Chlorophyll Variegated Mutants in Chrysanthemum

S K Datta* & D Chakrabarty

Abstract

Mutation breeding is an established method for crop improvement and has played a major role in the development of many new flower color/shape mutant varieties in ornamentals. The main bottleneck with vegetatively propagated plants is that the mutation appears as a chimera after treatment with physical and/or chemical mutagens. A small sector of a mutated branch or flower cannot be isolated using the available conventional propagation techniques. A novel technique has been standardized for the management of such chimeric tissues through direct shoot regeneration from chrysanthemum florets. This direct novel regeneration protocol has been successfully used not only for the isolation of chimeric mutant tissues developed through sports, but also to develop a series of new flower color/shape mutants through induced mutagenesis. Gamma radiation and tissue culture techniques have been optimized to regenerate plants from stem internodes, stem nodes, shoot tips and ray florets for *in vitro* management of chimera and for *in vitro* mutagenesis. Chimera isolation has practical importance not only for chrysanthemum but for breeding of other ornamentals also. The present technique will open up a new way for isolating new flower color/shape ornamental cultivars through retrieval of mutated cells.

Introduction

Induced mutagenesis is an established method for plant improvement, and the technique has been successfully exploited for development of new and novel ornamental varieties in general and chrysanthemum in particular [1-3]. A large number of new flower color varieties have developed in chrysanthemum through sports. The main bottleneck of induced mutagenesis with vegetatively propagated plants is that the mutation appears as a chimera after treatment with physical and/or chemical mutagens. Sports are also chimeric in nature. Mutated cells are present along with normal cells in chimeric tissues. The size of the mutant sector varies from a narrow streak on a petal to the entire flower head and from a portion of a branch to the entire branch. The mutated tissue can be isolated in pure form when a portion of a branch or an entire branch is mutated. However, a small sector of a mutated branch or flower cannot be isolated using the available conventional propagation techniques. Therefore, many mutagen-induced new flower color/shape mutants or spontaneously developed mutants are lost due to lack of microtechnique for management of such chimeric tissues either *in vivo* or *in vitro*. *In vitro* regeneration methods for chrysanthemum are well established [4-8]. Reports of adventitious shoot regeneration from floret explants of chrysanthemum are also available, but in all cases shoots were produced from floret-derived callus [9-11], and there is always a loss of somatic genetic homogeneity with a lengthy callus phase [12-13]. Here, we report a novel technique, standardized for isolation of new chimeric flower color/shape mutants through *in vitro* direct shoot

regeneration from ray florets and development of solid mutants through *in vitro* mutagenesis in chrysanthemum.

Materials and Methods

Plant materials

Chrysanthemum morifolium Ramat was selected as material for management of chimera and *in vitro* mutagenesis work.

Plant sport

In the germplasm collection of National Botanical research Institute, Lucknow, India, one plant of large white flowered chrysanthemum cv. 'Kasturba Gandhi' developed a few yellow florets due to a spontaneous mutation. Yellow florets were collected and subjected to direct regeneration of shoot buds using suitable tissue culture medium [14-15].

Gamma irradiation

Rooted cuttings (13 cm height) of different December-January flowering chrysanthemum ('Puja', 'Lilith', 'Maghi', 'Purnima' and 'Colchi Bahar') cultivars were treated with 1.5, 2.0 and 2.5 Krad of Gamma-rays (^{60}Co radiation source) and grown in the field upto flowering. Plants showing chimeric mutated florets were selected, and mutated ray florets were cultured on agar-solidified basal medium [14] supplemented with sucrose and different combinations of BAP/kinetin and NAA [16-20].

Surface sterilized ray florets of different cultivars ('Lalima', 'Flirt', 'Puja', 'Maghi' and 'Sunil') were treated with 0.5 and 1.0 krad Gamma-rays before transfer to culture. All the regenerated shoots were rooted in suitable medium and rooted plantlets were subsequently planted in field and observations were taken until flowering [21-22].

Results and Discussion

All the direct and callus regenerated plants from chimeric florets of 'Kasturba Gandhi' produced flowers true to the chimeric floret color i.e. yellow [16]. The other morphological characters of 'Kasturba Gandhi' and its new yellow flower color mutant were the same (Fig. IV-Y).

'Maghi' is a pompon type, mauve color, small-flowered, late-blooming variety of chrysanthemum. One plant each from 1.5 and 2.0 krad treatment showed few chimeric florets with new colors of one flower-head. The new colors were white and yellow. Plants were regenerated in pure form from both the mutated florets on MS medium containing 0.2 mg l^{-1} NAA and 1 mg l^{-1} BAP [15]. 'Maghi' is a late-blooming variety, flowering in the end of January under the sub-tropical Lucknow climate, India, when no other chrysanthemum flowers are available. The isolated white and yellow varieties are very attractive and will create a good impact in the floriculture industry (Fig. 1A-H).

'Lilith' is a double Korean, white small-flowered chrysanthemum. Two and three plants showed flower color mutations in 1.5 and 2.0 krad respectively. In all cases the flower color mutation was yellow. A total of 59 yellow ray florets from sectorial flower head chimera were inoculated in media and 14 explants showed shoot bud formation. The floret color

Floriculture Laboratory, National Botanical Research Institute, Lucknow 226001, U.P., India

* Present address : CSIR, Emeritus Scientist, Madhyamgram Experimental Farm, Acharya J. C. Bose Biotechnology Innovation Center, Bose Institute, Jessore Road, Madhyamgram, 24-Parganas (N), Kolkata 700129, India. E-mail : subodhskdatta@rediffmail.com; subodhskdatta@yahoo.com

of all the tissue culture raised plants was yellow, i.e. true to the explant color [19] (Fig. 1R-U).

Chlorophyll variegation in leaves was detected after treatment with gamma radiation in cvs. 'Maghi' and 'Lilith'. Chlorophyll variegations were regenerated subsequently through vegetative propagation, i.e. by cuttings. *In vitro* direct regeneration from variegated leaf explants could not be standardized.



Figure 1 Management of chimera for development of new flower color/shape and chlorophyll variegated mutants in chrysanthemum. (A) Original chrysanthemum cv. Maghi, (B) Sectorial chimera (yellow) of cv. Maghi, (C) Sectorial chimera (White and Yellow) of cv. Maghi, (D) Shoot bud regeneration from mutated segments of ray florets of Maghi, (E) Plant established in pure form as new variety from sectorial white mutated tissue of Maghi, (F) Plant established in pure form as new variety from sectorial yellow mutated tissue of Maghi, (G-H) Chlorophyll variegated mutants isolated from Maghi, (I) Sectorial chimera (yellow) of cv. Puja, (J) Mutated florets of Puja, (K) Shoot bud regeneration from mutated segments of ray florets of Puja, (L-M) Plant established in pure form as new variety from sectorial mutated tissue of Puja, (N) Original chrysanthemum cv. Purnima, (O) Sectorial chimera (yellow) of cv. Purnima, (P) Shoot bud regeneration from mutated segments of ray florets of Purnima, (Q) Plant established in pure form as new variety from sectorial yellow mutated tissue of Purnima, (R) Original chrysanthemum cv. Lilith, (S) Sectorial chimera (yellow) of cv. Lilith, (T) Shoot bud regeneration from mutated segments of ray florets of Lilith, (U) Plant established in pure form as a new variety from sectorial yellow mutated tissue of Lilith, (V) Original chrysanthemum cv. Kasturba Gandhi, (W) Spontaneous sectorial chimera (yellow) of cv. Kasturba Gandhi, (X) Shoot bud regeneration from mutated segments of ray florets of Kasturba Gandhi, (Y) Plant established in pure form as new variety from sectorial yellow mutated tissue of Kasturba Gandhi.

'Purnima' is a ball type, white, large-flowered chrysanthemum mutant, developed through gamma irradiation from 'Otome Zakura' with mauve flower color (Fig. 1N-Q). 'Colchi Bahar' is a decorative type terracotta red flower color mutant chrysanthemum, developed through colchicine

treatment from 'Sharad Bahar' with purple flower color. Sectorial yellow floret mutations were detected after irradiation with 1.5 and 2.0 krad of Gamma-rays in both varieties respectively. Mutated ray florets were cultured on agar-solidified Murashige & Skoog [14] basal medium supplemented with sucrose and different combinations of BAP/kinetin and NAA. Plantlets developed through direct shoot organogenesis flowered true-to-explant floret color in both the cultivars [17, 18].

'Puja' is a decorative type chrysanthemum. Few florets of two flowers from treated population showed chimeric mutations. The original floret color of 'Puja' was red-purple and florets were flat spoon shaped. One of the mutant floret colors was yellow-orange with original flat florets and another mutant floret color was yellow-orange with tubular florets. Regenerated plants flowered true-to-explant floret color and shape [20] (Fig. 1I-M).

Ray florets of five decorative type chrysanthemum cvs. 'Lalima', 'Flirt', 'Puja', 'Maghi', and 'Sunil' after inoculation were irradiated with gamma radiation and all the regenerated shoots were isolated, rooted and transplanted in the field after hardening. Somatic mutations in flower color and floret shape were detected in Gamma-ray-treated population but no chimeric nature of mutation was detected in any plant. All the mutations were solid in nature. 'Lalima' was grey-red and florets were flat spoon shaped. Two mutants were obtained in the 0.5Gy irradiated plants. Both mutants were yellow colored but one had flat spoon shaped ray florets similar to the original cultivar, while the other had tubular florets. The original ray floret color of 'Flirt' was grey-purple. Two types of flower color mutations were observed with 0.5Gy treatments. In one mutant ray floret color was red with yellow tip, while in another mutant the ray floret color was yellow with very fine red stripes. Slight changes in ray floret morphology were observed in both mutants. The ray floret color of 'Puja' was purple, while its mutant developed in 1Gy treatment was darker in color. The mutant detected in 'Maghi' with 1Gy treatment showed change in floret shape. The original shape of ray florets was flat type, while it was tubular in the mutant. The original ray floret color of 'Sunil' was red-purple, but the mutant developed at 1Gy treatment was darker in color. The shape of the mutant ray florets changed from flat type to tubular type. The mutants were propagated vegetatively and have produced true-to-type florets [21, 22].

The difficulty in regenerating whole plants from sectorial mutated tissues is the main bottleneck in induced mutagenesis technique and a huge number of such spontaneous and/or induced mutant tissues were lost. Standardization of such regeneration protocol was most essential for isolation of chimeric tissues for commercial exploitation. The present *in vitro* technique has opened a new way for isolating new ornamental varieties through retrieval of chimeric tissues. This technique has practical importance not only for chrysanthemum but for other ornamentals also. The present experiments also indicated that solid flower color/shape mutants can be developed through direct *in vitro* mutagenesis by avoiding a chimeric phase.

ACKNOWLEDGEMENTS

Thanks are due to the Director, NBRI, Lucknow, India, for providing the facilities. Authors thankfully acknowledge Department of Biotechnology, Ministry of Science and Technology, Government of India for financial assistance of the project. Dr. S.K.Datta thanks the Director, Bose Institute, Kolkata and CSIR, New Delhi, for his present association with the institute as CSIR, Emeritus Scientist. Dr. Debasis Chakrabarty also thankfully acknowledges CSIR for financial assistance during his Ph.D programme.

BIBLIOGRAPHY

1. Datta, S.K. Chrysanthemum cultivars evolved by induced mutation at National Botanical research Institute, Lucknow, India. *Chrysanthemum* 49, 72-75 (1988).

2. Ahloowalia, B.S. *et al.* Global impact of mutation-derived varieties. *Euphytica* **135**, 187-204 (2004).
3. Broertjes, C., Van Harten, A.M. Applied mutation breeding for vegetatively propagated crops, Elsevier, Amsterdam (1988).
4. Hill, G.P., Shoot formation in tissue cultures of Chrysanthemum 'Bronze Pride', *Physiol Plant* **21**, 386-389 (1969).
5. Ben-Jaccov, J., Langhans, R.W. Rapid multiplication of Chrysanthemum plants by stem tip proliferation. *Hort Sci.* **7**, 289-290 (1972).
6. Earle, E.D., Langhans, R.W. Propagation of Chrysanthemum *in vitro*. I. Multiple plantlet from shoot tips and the establishment of tissue culture. *J. Am. Soc. Hort. Sci.* **99**, 128-132 (1974).
7. Kaul, V. *et al.* Shoot regeneration from stem and leaf explants of *Dendranthema grandiflora* Tzvelev (Syn. *Chrysanthemum morifolium* Ramat.). *Plant Cell Tiss Organ Culture* **21**, 21-30 (1990).
8. Lu, C.U. *et al.* Efficient direct plant regeneration from stem segments of Chrysanthemum (*Chrysanthemum morifolium* Ramat. Cv. Royal Purple). *Plant Cell Rep* **8**, 733-736 (1990).
9. Bush, S.R. *et al.* Plantlets from petal segments, petal epidermis and shoot tips of the periclinal chimera, *Chrysanthemum morifolium* "Indianapolis". *Am. J Bot.* **63** 729-737 (1976).
10. De Jong, J., Custers, J.B.M. Induced changes in growth and flowering of Chrysanthemum after irradiation and *in vitro* culture of pedicels and petal epidermis. *Euphytica* **35**, 37-148 (1986).
11. Malaure, R.S. *et al.* The production of novel plants from florets of Chrysanthemum morifolium using tissue culture 1. Shoot regeneration from ray florets and somaclonal variation exhibited by the regenerated plants. *J Plant Physiol* **139**, 8-13 (1991).
12. Bush, S.R. *et al.* Plantlets from petal segments, petal epidermis and shoot tips of the periclinal chimera, *Chrysanthemum morifolium* "Indianapolis". *Am. J Bot.* **63**, 729-737 (1976).
13. Sutter, E., Langhans, R.W. Abnormalities in Chrysanthemum regenerated from long term cultures. *Ann Bot.* **48**, 559-568 (1981).
14. Murashige, T., Skoog, F.A revised medium for rapid growth and bio-assays with tobacco tissue culture. *Physiol. Plant* **15**, 473-497 (1962).
15. Chakrabarty, D. *et al.* Management of chimera through direct shoot regeneration fom florets of chrysanthemum (*Chrysanthemum morifolium* Ramat.) *J. Hort. Sci. Biotechnol* **74**, 293-296 (1999).
16. Chakrabarty, D. *et al.* Retrieval of new colored chrysanthemum through organogenesis from sectorial chimera. *Curr. Sci.* **78**, 1016-1061 (2000).
17. Mandal, A.K.A. *et al.* Application of *in vitro* techniques in mutation breeding of chrysanthemum. *Plant Cell, Tiss Organ Culture* **60**, 33-38 (2000).
18. Mandal, A.K.A. *et al.* *In vitro* isolation of solid novel flower color mutants from induced chimeric ray florets of chrysanthemum. *Euphytica* **114**, 9-12 (2000).
19. Dwivedi, A.K. *et al.* Gamma ray induced new flower color chimera and its management through tissue culture. *Ind. J Agric. Sci.* **70**, 853-855 (2000).
20. Datta, S.K. *et al.* Gamma ray-induced genetic manipulations in flower color and shape in *Dendranthema grandiflorum* and their management through tissue culture. *Plant Breed* **120**, 91-92 (2001).
21. Misra, P. *et al.* Mutation in flower color and shape of *Chrysanthemum morifolium* induced by gamma irradiation. *Biol Plant* **47**(1), 153-156 (2003/4).
22. Datta, S.K. *et al.* *In vitro* mutagenesis – a quick method for establishment of solid mutant in chrysanthemum. *Curr. Sci.* **88**(1), 155-158 (2005).

Development of Promising Seedless *Citrus* Mutants Through Gamma Irradiation

I Sutarto^{1,*}, D Agisimanto² & A Supriyanto²

Abstract

Citrus are highly heterozygous, polygenic plants with a long juvenile period, whereby conventional breeding is laborious, time-consuming and expensive. Therefore, mutation breeding was carried out. Bud woods of two Indonesian local commercial mandarin (*Citrus reticulata* L. Blanco) cv. SoE and Garut, and pummelo (*Citrus grandis* L. Osbeck) cv Nambangan were exposed to Gamma-ray doses of 20, 40 and 60Gy, and irradiated bud woods were then budded onto rootstocks cv. Japanche citroen. Three-year-old untreated and irradiated plants grown in pots were checked for fruit characters such as seeds number per fruit, and color of flesh and skin. Selected promising mutant lines were found in terms of seedlessness in cvs SoE mandarin and Nambangan pummelo, and nearly seedless cultivars were found in cvs Soe, Garut and Nambangan when bud woods were irradiated at 20 and 40Gy. The performance of promising mutant lines obtained is now being observed and are propagated in the field to confirm their stability.

Introduction

Citrus are among the most important fruit crops in Indonesia, and their consumption has increased steadily with an increase in population. In modern and industrialized citriculture, highly adaptable varieties with high quality should be cultivated to secure high profitability. In many countries, the target of *Citrus* improvement has focused on high fruit qualities (e.g., seedless, easy peeling and mandarin types) and disease resistance. These breeding programmes have been carried out through conventional breeding (hybridization), mutation breeding, and biotechnological techniques. However, *Citrus* breeding has been confronted with difficulties such as high heterozygosity, polygenic traits and a long juvenile period, regardless of breeding techniques used.

Several important commercial *Citrus* varieties, such as Washington navel orange, Marsh grapefruit, Shamouti Orange, and Salustiana orange, have arisen as bud "sprout" mutation. Mutation induction techniques such as radiation or chemical mutagens are good tools for increasing variability in crop species because spontaneous mutations occur with an extremely low frequency. Mutation techniques have significantly contributed to plant improvement worldwide, and have made an outstanding impact on the productivity and economic value of some crops [1].

This study describes recent progress of induced mutation by Gamma-rays for breeding promising mutant lines of seedless *Citrus*, namely mandarin (cvs. *Citrus reticulata* L. Blanco cvs. SoE and Garut) and pummelo (*Citrus grandis* L. Osbeck cv Nambangan).

Materials and Methods

Gamma irradiation and plant maintenance

Fresh, non-dormant bud woods of mandarin (*Citrus reticulata* L. Blanco) cvs. SoE and Garut, and pummelo (*Citrus grandis* L. Osbeck) cv Nambangan were exposed to Gamma-rays at the doses of 0, 20, 40, 60 and 80Gy on April 2003, and were chip-budded onto rootstock 'Japanche citroen' (JC), two days after irradiation. Plants originated from irradiated bud woods along with plants from untreated bud woods were grown in the same plot for further observation. The number of surviving bud woods was measured four months after irradiation and the survival percentage of bud wood was calculated. 'Japanche citroen' (JC) was used as rootstock. Mother plants were maintained in the screen house of the Indonesian Citrus and Subtropical Fruits Research Institute (950 m above sea level) in Batu, East Java, Indonesia. Shoot length of growing bud woods was observed six times during four months.

Morphological Fruits Characters

Morphological characters of fruits were determined based on the International Plant Genetic Resources Institute (IPGRI) protocols [2]. Fruits were collected from the fifth flushes originating from irradiated bud woods (MV5) and more. Fruits were grouped based on the number of seeds per fruit as either seedless (0-5 seeds per fruit) or nearly seedless (6-10 seeds per fruits), according to Varoquaux, *et al.* [3]. Mutated branches for seedless were taken as bud woods, and grafted on to JC rootstocks. These plants were planted on individual pots and harvested fruits were evaluated for seedless.

Table 1. Number of bud wood per treatment and survival percentage of bud wood

No	Cultivar/Treatments	Survival	Total	Survival %
1	Keпок SoE (20Gy)	33	40	82.5
2	Keпок SoE (40Gy)	16	35	45.7
3	Keпок SoE (60Gy)	0	27	0
4	Keпок Garut (20Gy)	47	52	90.4
5	Keпок Garut (40Gy)	12	23	52.2
6	Keпок Garut (60Gy)	9	38	23.7
7	Pamelo Nambangan (20Gy)	20	21	95.2
8	Pamelo Nambangan (40Gy)	19	24	79.2
9	Pamelo Nambangan (60Gy)	16	25	64.0
Total		172	285	59.2

Results

Survival of bud wood

About 285 bud woods of Keпок SoE and Garut (mandarin) and Nambangan (pummelo) were gamma irradiated to induce variability.

¹ Center for Application of Isotopes and Radiation Technology (BATAN), Jalan Cinere, Pasar Jumat, Jakarta 12440, Indonesia.

² Research Institute for Citrus and Subtropical Horticulture Crops. Jalan Raya Tlekung no. 1, Junrejo, Kota Batu 63105. Indonesia.

* Corresponding author. E-mail: isutarto@batan.go.id

Survival percentage of bud woods to gamma irradiation was different among doses and varieties. Keprok SoE survived up to 40Gy only, while Keprok Garut's bud woods were able to produce new shoots after irradiation at a dose of 60Gy. These two mandarins showed higher survival rate at low doses of Gamma-rays. As indicated in **Table 1**, survival percentage of bud woods of mandarin decreased as gamma irradiation doses increased. Survival percentage on pummelo has shown that this variety was able to survive at a higher percentage at doses ranging from 20-60Gy. In total, only 172 out of 285 bud woods were flushed in the first three months after grafting.

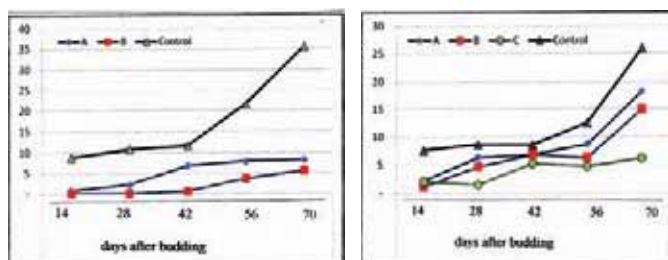

Figure 1 Development of shoot-length (cm) of mandarin from K. Soe and K. Garut (left) and pummelo of Nambangan (right) derived from irradiated shoots observed in the nursery.

Table 2. Variation on seed number per fruit collected and observed from seedless plants

Varieties	Number of seed per fruit	Number of seedless plants			Number of seeds/fruit in untreated plants
		20 Gy	40 Gy	60 Gy	
C. reticulata cv. Keprok SoE	0-5	11	9	0	12-14
	6-10	47	9	0	
C. reticulata cv. Keprok Garut	0-5	14	1	0	10-33
	6-10	9	4	0	
C. grandis cv. Nambangan	0-5	3	1	0	65-140



Figure 2 Citrus seedless mutants on *Citrus reticulata* L. Blanco cvs Keprok Garut and Keprok SoE.



Figure 3 Citrus seedless and changed color mutants on *Citrus grandis* L. Osbeck cv. Nambangan.

Time to produce new shoots was also different among doses of gamma and varieties. In Keprok SoE, irradiation delayed the first shoot growth

(**Fig. 1**). After four months, there was no difference in shoot growth between gamma irradiation at 20Gy and that at 40Gy.

Long-term observation showed that pummelo was resistant to low doses of Gamma-rays (20-40Gy). Seedlings derived from 20-40Gy irradiation treatment repressed shoot growth slightly. On the other hand, plants derived from 60Gy of gamma radiation grew slower than other treatments.

Fruit characters

Fruits were collected from three-year-old trees. In mandarin, 11 and nine fruits checked were seedless (0-5 seeds per fruit) in 20 and 40Gy gamma irradiation treatment, respectively (**Table 2**). Some fruits were completely seedless in Keprok Soe (**Fig. 2**). Gamma irradiation on mandarin also produced nearly seedless fruits (47 and nine seeds at 20 and 40Gy, respectively). All branches were labelled and grafted for further observations.

Gamma irradiation induced variations in fruit characters other than seedlessness, i.e., skin color (yellowish skin), flesh color (green flesh) and endocarp thickness, in pummelo. Four typical new characters were recorded from those branches, namely yellowish skin, green flesh, seedlessness and endocarp thickness (**Fig. 3**). Two branches derived from 20 gray irradiated bud woods bore completely seedless fruits. On the other hand, fruits with two seeds and green flesh were produced in a branch derived from 40 gray irradiated bud woods.

Discussion

Spontaneous and induced mutations have already played an important role in breeding of many fruit crops. Mutagenesis has already been used to improve many useful traits affecting plant size, flowering time and fruit ripening, fruit color, self-compatibility, self-thinning, and resistance to pathogens. Nowadays, the number of cultivars derived from mutation induction increases constantly [4, 5, 6].

Inducing mutations by Gamma-rays has been effectively used with several species of *Citrus*. Irradiation of Gamma-rays on bud wood can produce higher frequencies of mutation, leading to the creation of new variants compared to the control. Selection and testing of *Citrus* trees derived from mutations takes several years before they can be used commercially. In the present study, induced mutagenesis on *Citrus* can improve characters derived from the original variety three years after obtaining mutation bud woods showing seedless characters as well as new color flesh and skin. Even though it is not a final result, this procedure is much faster than conventional hybridization.

In *Citrus*, several attempts at inducing variability were conducted with some reports on seedless, spineless, changed color of fruit and juice [7]. Radio-sensitivity (LD_{50}) of acute exposure of *Citrus* ranges from 40-100Gy [8, 9], depending on species and varieties. Scion (bud wood), seeds, floral stage embryos, and *in vitro* material of *Citrus* were exposed to Gamma-rays.

Citrus sunki was irradiated with 20 or 40Gy of Gamma-rays at three different floral stages [10] and nucellar seedling [11]. A spine free mutant was selected from irradiated nucellar. In *Citrus sinensis*, immature seeds were exposed to Gamma-rays at the doses 80-100Gy [9], while those polyembryonic seeds were exposed to Gamma-rays of 100Gy [12]. Two seedless mutants were selected, leading to release of a new cultivar "Hongju 418 and Hongju 420" [12]. *Citrus paradisi* cv Hudson were exposed with thermal neutron, leading to release of a seedless mutant 'Star Ruby' [13]. Another five nearly seedless mutants of *Citrus paradisi* cv Foster were also selected from irradiated bud wood at the dose 50 gray of Gamma-rays [14].

Citrus limon cv Eureka and Israeli Villafranca were irradiated by 60 and 50Gy of Gamma-rays respectively, and completely new seedless varieties were released [15]. A red color of flesh and juice mutant derived from 80Gy gamma irradiation of *Citrus paradisi* cv Ruby Red was released as

cultivar Rio Red in 1984 [16]. Bud woods of pummelo, mandarin and Navel Orange irradiated by Gamma-rays at doses of 30 – 75Gy showed high sensitivity at higher dose, while Valencia and grapefruit produced more seedless fruits from those at the higher doses [17]. Irradiation of Gamma-rays (10-60Gy) on calli *in vitro* proliferation stage resulted in high mortality at the dose of 60Gy [4] When nucellus and embryonic masses of *Citrus sinensis* cv. Pera were exposed to gamma irradiation at the dose 0 – 160Gy and 0 – 189Gy respectively, normal growth of plantlets was obtained from irradiated nucellus exposed to 20 – 80Gy [18].

Here, complete seedless and seedless were found from doses of 20 and 40Gy on Keprok SoE and pumello Nambangan. One branch of pumello derived from gamma irradiation with a dose of 40Gy produced different juice color and skin. However, survival percentage of mandarins decreased largely at the dose of 60 gray. In pummelo, survival percentage decreased little at 60 gray, but no promising mutation lines were obtained. Therefore, it is likely that appropriate dosage in Indonesian cultivars of mandarin and pummelo is lower than that reported by other researchers.

Selected branches of trees have been grafted to rootstocks in the field. The new seedlings mutants obtained are now under investigation in the field to confirm their stability, agronomic advantages and for genetic tests with molecular markers.

ACKNOWLEDGEMENTS

This work was done under the IAEA TC Project INS/5/031 entitled Mutation Breeding of Horticultural Crops.

BIBLIOGRAPHY

- Ahloowalia, B.S. et al. Global impact of mutation-derived varieties. *Euphytica* **135**, 187–204 (2004).
- International Plant Genetic Resources Institute. Descriptors for Citrus. International Plant Genetic Resources Institute, Rome, Italy. (1999).
- Varoquaux, F. et al. Less is better: New approaches for seedless fruit production. *Trends in Biotechnology* **18**, 233-242 (2000).
- Predieri, S. Mutation induction and tissue culture in improving fruits. *Plant Cell. Tissue and Organ Culture* **64**, 185-210,
- Hearn, C.J. Development of seedless grapefruit cultivars through budwood irradiation. *Hortscience* **20**, 84 (2001).
- Maluszynski, M. et al. Application of *in vivo* and *in vitro* mutation techniques for crop improvement. *Euphytica* **85**, 303–315 (1995).
- Maluszynski, M. et al. Officially released mutant varieties – the FAO/IAEA database. *Mutation Breeding Review* **12**, 1–84 (2000).
- Sanada, T., Amano, E. Induced mutation in fruit trees. In JAIN, SM., et al., Somaclonal variation and induced mutations in crop improvement. Kluwer Academic Publishers. England. p.401- 419 (1998).
- Sparow, A.H. et al. Radiosensitivity studies with woody plants. I. Acute gamma irradiation survival data for 28 species and predictions for 190 species. *Radiation Bot.* **8**, 149-186 (1968).
- Spiegel-Roy, P., Padova, R. Radiosensitivity of Shamouti orange (*Citrus sinensis*) seeds and buds. *Radiation Bot* **13**, 105-110 (1973).
- Ikeda, F. Induced bud sports in *Citrus sunski* from Nucellar seedlings. In: Improvement of vegetatively propagated plants and tree crops through induced mutation. p.95-96 (1976).
- Kukimura, H.F. et al. Brief description of mutation in vegetatively propagated and tree crops. *Gamma Field Symp* **15**, 79-82 (1976).
- Chen, S. et al. Studies on the seedless character of *Citrus* induced by irradiation. *Mutation Breeding Newsletter* **37**, 8-9 (1991).
- Micke, A. et al. Plant cultivars derived from mutation induction or the use of induced mutants in crop breeding. *Mutation Breeding Reviews* **3**, 1-92 (1985).
- Hearn, C.J. Development of seedless grapefruit cultivars through budwood irradiation. *Hortscience* **20**, 84 (1985).
- Spiegel-Roy, P. et al. Seedless induced mutant in highly seeded lemon (*Citrus limon*). *Mutation Breeding Newsletter* **26**, 1-2 (1985).
- Wu, S. et al. Using Gamma-rays to induce mutations for seedlessness in *Citrus*. *Mutation Breeding Newsletter* **27**, 14 (1986).
- Froneman, I.J. et al. Producing seedless *Citrus* cultivars with gamma irradiation. *Proc. Int. Soc. Citriculture*, 159-163 (1996).
- Neto, A.T. et al. *In vitro* mutagenesis in *Citrus* Breeding. I. Gamma rays sensitivity of cultivar Pera explants. *Bragantia Campinas* **53**, 167-176 (1994).

The Development of New Genotypes of the White Yam by Mutation Induction Using Yam Mini-tubers

E C Nwachukwu*, E N A Mbanaso & K I Nwosu

Abstract

A method for the genetic improvement of the white yam, *Dioscorea rotundata* by mutation induction was investigated by irradiating mini-tubers of the yam with Gamma-rays. Batches of 150 mini-tubers of the well adopted local cultivar "Obiaoturugo" were gamma irradiated at doses of 0, 10, 20, 30, 40, 50, 60, 70, 80 and 90 Gray (Gy) using the ⁶⁰Co gamma source at the Center for Energy Research and Development, Obafemi Awolowo University, Ife-Ife in 2004. Each irradiated tuber including the control was divided into sets weighing 10-15g and planted in the field to establish the first mutated vegetative generation (MV₁), separating sets from the head (H) and the tail (T) regions. In 2005, first generation tubers harvested from the MV₁ generation were used to establish the MV₂ populations. At the MV₁ generation, increasing doses of Gamma-ray irradiation progressively inhibited sprouting of sets isolated from treated mini-tubers. These effects were more severe on sets from the tail (T) region than those from the head (H) region. Also, plant height, number of leaves, number of nodes and mean tuber yields per stand decreased with increased Gamma-ray doses. LD₅₀ and GR₅₀ were observed at 40Gy and 30Gy, respectively. At the MV₂ generation, the observed differences among the treatments means disappeared (or were not significant). MV₂ yam lines with modified vegetative characteristics were isolated. Distinct lines with bunchy and bushy vegetation and bushy with spreading vines were isolated. This is relevant, as one of the genetic improvement objectives apart from high tuber yields in yam, is for the development of lines that may be cropped without staking.

Introduction

Yams are very important in the economic and social life of Nigerians. Nigeria is the largest world producer of the crop accounting for about 75% of the crop produced in West Africa [1]. Among yams, *Dioscorea rotundata* (White yam) is the most widely cultivated. Although, *D. rotundata* is believed to be indigenous to West Africa, the species has one of the lowest yields [2]. The low yield is partly due to limited attempt at breeding the crop for high yields. Coursey and Martin [3] have the belief that it is possible to increase the yield of yams through hybridization. The successful germination of true yam seeds by various authors [4, 5, 6, 7] heightened this belief. However, more than 25 years after the successful germination of true yam seeds, it is only recently that new white yam hybrid varieties have been developed and released by breeders from IITA, Ibadan, in collaboration with National Root Crops Research Institute, Umudike. Many workers believe that the improvement of yams over the years has been through the selection of tubers with appealing characters and the vegetative propagation of such tubers by farmers. As a result of this asexual method of propagation, many important species and cultivars have lost the ability for efficient sexual reproduction [8]. In *D. rotundata*, many good and important cultivars have never been known to flower while others produce only male or female flowers. Only

few cultivars are truly dioecious [6, 9]. These and the problem of high ovule abortion after crosses [10], low fruit and seed production, and low genetic variability for many characters in yam cultivars [11], make yam a difficult crop to improve by hybridization. Therefore, mutation induction offers a veritable tool for the genetic improvement of yams. In fact, some important agronomic traits in yams are lacking in the Nigerian yam germplasm, such as dwarf erect vegetation that may not require staking for high yield. Such traits need to be induced.

Materials and Methods

Batches of 100 mini-tubers of *Dioscorea rotundata*, cv. "Obiaoturugo" were irradiated with Gamma-rays at doses, 0, 10, 20, 30, 40, 50, 60, 70, 80 and 90 Gray (Gy) using the ⁶⁰Co gamma source at the Center for Energy Research and Development, Obafemi Awolowo University, Ife-Ife in 2004. Each irradiated tuber including the control was divided into sets weighing 10-15g and planted in the field to establish the first mutated vegetative generation (MV₁). The sets from the head region (H) were planted separately from those from the tail region (T), using a split-plot experiment laid out in the field in a randomized complete block design (RCBD) with four replications.

Data collected was plant height (canopy height), number of leaves per stand and number of vines per stand. Others included the number of days from planting to the register of the first sprout and 50% sprout, the total number of sets planted and the number that sprouted. These were used to calculate percentage of sprout, relative survival and lethality. The relative survival (RS) was calculated as

$$RS = (\% \text{ survival of dose treatment } \times 100) / \% \text{ survival of control}$$

Lethality was estimated as Lethality = 100 – RS [12]

Tubers were harvested when senescence set in and the data collected from the harvested tubers was the number of tubers per stand and the tuber yield. Other traits assessed were the diameter (D) and length (L) of individual tubers, which were used to calculate the tuber shape index (TSI) as $TSI = \frac{D}{L}$ [13].

All data was subjected to statistical analysis based on RCBD method.

A total of 5,000 first-generation tubers (lines) harvested from MV₁ generation were used to establish MV₂ population. The field lay out in the present trial was similar to that of the earlier trial. Each plot contained equal number of lines and a minimum of five stands per line was planted. During data collection, at least three stands per line were sampled. During replication, care was taken to plant out each line (tuber) for easy identification and follow-up. However, during statistical analysis, data were pooled and expressed on per stand basis.

The MV₂ generation population was also screened and mutant lines with modified vegetative characters were tagged and isolated.

Results, Discussion and Conclusion

Increasing doses of Gamma-ray progressively inhibited sprouting of sets of treated mini-tubers (Table 1) as indicated by the number of days to first sprout emergence in the MV₁ generation.

National Root Crops Research Institute, Umudike, P. M. B. 7006, Umuahia, Nigeria

* Corresponding author. E-mail: nwachukwuec@yahoo.com

The number of days to 50% sprout and the mean percentage sprout (Table 2) in the MV₁ generation also showed the same trend. When the number of days to 50% sprout was compared among the treatment means, setts from the H region treated to 0 – 60Gy gamma irradiation recorded a range of 25.5 days to 81.1 days and those from the T regions recorded a range of 38.3 days to 95.0 days. Setts, isolated from mini – tubers treated to 70Gy and above Gamma-ray failed to sprout or did not record up to 50% sprout. In all cases, the effects were more severe on setts isolated from the tail (T) region than those from the head H region indicating that the tail region is more radiation sensitive than the head region.

Table 1. The effect of Gamma-ray dose rate on the mean number of days to first sprout of yam tuber setts isolated from the head (H) and tail (T) regions of irradiated yam tubers at the MV₁ and MV₂ generations

Gamma-ray Dose (Gy)	MV ₁			MV ₂		
	H	T	Mean	H	T	Mean
0	18.0	22.2	20.1	19.8	19.7	19.8
10	19.8	27.3	23.5	18.1	20.1	19.1
20	19.8	27.3	23.5	20.1	21.1	20.6
30	20.5	32.0	26.3	19.0	18.2	18.6
40	24.0	32.8	28.4	18.6	19.1	18.9
50	27.3	39.3	32.3	18.7	18.6	18.7
60	30.5	63.0	46.8	20.1	20.2	20.2
70	32.8	73.5	51.9	20.0	19.9	20.0
80	62.5	83.3	72.9	19.7	18.9	19.3
Mean	28.3	44.5	-	19.3	19.5	-

F – LSD (P=0.05) for comparing MV₁ means between two tuber sett source means = 7.8; between two Gamma-ray dose means = 5.1; between two Gamma-ray dose means at the same and different sett source level = 10.2. MV₂ means are not significantly different.

Table 3 illustrates how the mean canopy heights (plant heights), the mean number of leaves and the mean tuber yield per stand of stands from treated setts also decreased with increased Gamma-ray dosages. These effects were also more severe on setts isolated from the T regions than those from the H regions.

Table 2. The effect of Gamma-ray dose rate on the mean number of days to 50% sprout^a and mean percentage sprout^b of yam tuber setts isolated from the head (H) and tail (T) regions of yam tubers treated to Gamma-ray irradiation

Gamma-ray Dose (Gy)	Mean number of days to 50% sprout						Mean percentage sprout					
	MV ₁			MV ₂			MV ₁			MV ₂		
	H	T	Mean	H	T	Mean	H	T	Mean	H	T	Mean
0	25.5	38.3	31.9	26.1	25.0	25.6	95.0	80.0	81.5	90.0	91.1	90.5
10	29.5	50.3	39.9	25.5	25.2	25.4	85.3	69.3	77.3	89.2	90.0	89.6
20	33.0	57.5	45.3	25.9	27.0	26.5	74.8	59.3	67.0	85.5	91.5	88.5
30	36.3	58.5	47.4	26.1	25.5	25.8	48.5	40.5	44.5	92.0	88.5	90.3
40	45.8	59.5	52.6	24.9	26.0	25.5	46.0	34.3	40.1	80.7	89.4	85.0
50	60.8	75.0	67.9	25.6	25.5	25.6	39.0	28.8	33.9	92.1	90.3	91.2
60	81.8	95.0	88.4	28.1	27.0	27.7	29.0	15.0	22.0	87.7	95.0	91.4
70	0.0	0.0	0.0	25.5	26.1	25.8	21.3	7.5	14.4	90.9	92.0	91.5
80	0.0	0.0	0.0	26.1	27.3	26.7	7.55	1.3	4.4	89.8	88.7	89.3
Mean	34.7	48.2	-	26.0	26.1	-	49.6	37.3	-	88.7	90.7	-

^a 0.0 = Setts treated to 70Gy and above Gamma-ray irradiation failed to sprout or did not record up to 50% sprout. F – LSD (P=0.05) for comparing MV₁ means. Between two tuber sett source means = 8.5 between two Gamma-ray dose means = 7.7 between two Gamma-ray dose means at the same and different sett source level = 10.9. MV₂ means are not significantly different.
^b F – LSD (P=0.05) for comparing MV₁ means between two tuber sett source means = 2.7, between two Gamma-ray dose means = 4.7, between two Gamma-ray dose means at the same and different sett source level = 6.6 MV₂ means are not significantly different.

Gamma-ray irradiation did not seem to affect the mean number of vines per stand, the mean number of tubers and the mean tuber shape index (TSI) of yam tubers raised from tuber setts isolated from the H and T regions of treated mini-tubers. LD50 (50% lethality) and GR50, (50% growth reduction) were obtained at 40Gy and 30Gy respectively. There was complete inhibition of sprouting (100% lethality) at doses over 80Gy, as shown in Table 4. In the MV₂ generation, however, there were no significant differences among the treatment means. The significant differences among the treatment means observed in the MV₁ generation disappeared in the MV₂ generation.

Gamma irradiation of crop plant parts results in three types of effects, physiological damage, (primary injury), factor mutations (gene mutations) and chromosome mutations, (chromosomal aberrations) [14]. All these effects are referred to as radiation injury and may manifest in several forms. They may include reduced sprouting ability when vegetative organs are used, survival ability, reduced plant heights, and reduced number of plant organs such as number of leaves. From the work reported here, there was a decreased sprouting ability with increasing doses of Gamma-ray. The same trend was repeated when the plant heights, and the number of certain plant organs, such as the number of leaves were considered.

The induced variability observed in the MV₁ generation (as a result of gamma irradiation) was the result of the cumulative effect of physiological damage, gene mutations and chromosome mutation. However, the contribution of physiological damage, (primary injury) is much higher than the contributions by gene mutation and chromosome mutations in the MV₁ generation. This is because gene and chromosome mutations occur at very low frequencies [15]. Gene and chromosome mutations can be transferred from MV₁ generation to the subsequent ones but physiological damage may not. For practical purposes, selection for mutants started from MV₂ generations [16], once physiological effects may have disappeared.

The most effective dose range for mutation induction in vegetatively propagated crop plants like the yams must be between dosages that may cause lethality of not more than 50% and growth reduction of not more than 50%. Brunner [17] recommended a dose treatment range that must allow the survival of 40 – 50% and or a retardation in growth of not more than 50%. Within this range, enough populations of the treated plant parts will survive the lethal effects of the mutagen as well as inducing

Table 3. The effect of yam ray dose on the mean canopy height^a (cm) (plant heights), mean number of leaves^b and on the mean tuber yield per stand^c of yam plants raised from tuber setts isolated from the head (H) and tail (T) regions of yam tubers treated to Gamma-ray irradiation at the MV₁ and MV₂ generations.

Gamma-ray Dose (Gy)	Mean plant height (cm)						Mean number of leaves						Mean tuber yield per stand					
	MV ₁			MV ₂			MV ₁			MV ₂			MV ₁			MV ₂		
	H	T	Mean	H	T	Mean	H	T	Mean	H	T	Mean	H	T	Mean	H	T	Mean
0	125.4	104.9	115.1	159.0	158.9	159.0	18.0	22.2	20.1	19.8	19.7	19.8	126.2	81.5	103.9	240.00	260.00	250.0
10	109.3	97.0	103.1	149.2	159.9	154.6	19.8	27.3	23.5	18.1	20.1	19.1	110.6	67.5	89.0	220.0	230.0	225.0
20	88.9	73.0	80.9	159.7	154.6	157.2	19.8	27.3	23.5	20.1	21.1	20.6	98.1	60.7	79.4	260.0	260.0	260.0
30	62.2	53.1	57.7	159.2	153.3	156.3	20.5	32.0	26.3	19.0	18.2	18.6	85.0	49.7	67.3	230.0	230.0	230.0
40	59.2	43.9	51.6	148.9	149.1	149.0	24.0	32.8	28.4	18.6	19.1	18.9	75.1	45.7	60.4	260.0	270.0	265.0
50	52.0	36.7	44.4	145.4	149.5	147.5	27.3	39.3	32.3	18.7	18.6	18.7	63.5	37.3	50.4	270.0	250.0	262.5
60	47.4	28.7	38.0	155.8	150.1	153.0	30.5	63.0	46.8	20.1	20.2	20.2	38.6	19.6	29.1	250.0	230.0	240.0
70	39.3	8.3	23.8	153.5	158.1	155.8	32.8	73.5	51.9	20.0	19.9	20.0	29.1	12.8	20.9	260.0	260.0	260.0
80	24.5	0.0	12.3	158.9	157.2	158.1	62.5	83.3	72.9	19.7	18.9	19.3	16.5	6.0	11.2	240.0	250.0	245.0
Mean	67.6	49.5	-	154.4	154.5	-	28.3	44.5	-	19.3	19.5	-	71.4	41.6	-	247.8	248.9	-

^a F-LSD (P=0.05) for tuber sett source means = ns; for Gamma-ray dose means = 10.9; for tuber sett source and Gamma-ray interaction = 15.5 ; F.LSD(0.05) for comparing MV₂ means = ns
^b F - LSD (P=0.05) for comparing MV₁ means between two tuber sett source means = 7.8, between two Gamma-ray dose means = 5.1 between two Gamma-ray dose means at the same and different sett source level = 10.2 ns = not significantly different. MV₂ means are not significantly different.
^c F- LSD (P = 0.05) for comparing MV1 Means Two tuber sett source means = 13.7 Two Gamma-ray dose means = 11.7 Two Gamma-ray dose means at The same or different setts source = 16. MV₂ treatment means are not significantly different.

Table 4. The effect of gamma irradiation on the percentage height of control, relative percentage sprout and lethality (%) of setts isolated from the head (H) and tail (T) regions of treated yam mini-tubers.

Gamma-ray dose (Gy)	Percentage height of control	Percentage sprout	Relative percentage sprout	Lethality
0	100	87.6	100	0
10	89.6	77.3	98.0	12.0
20	70.3	67.0	70.6	23.4
30	50.1	44.5	50.9	49.1
40	44.8	40.1	45.8	54.2
50	38.6	33.9	38.7	61.3
60	33.0	22.0	25.1	74.9
70	20.7	14.4	16.5	83.5
80	10.7	4.4	5.0	95.0
90	0.0	0.0	0.0	100

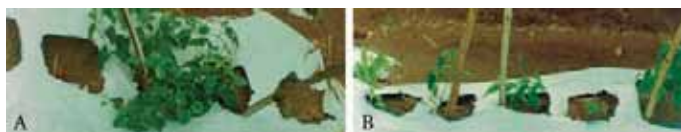

Figure 1 White yam mutants developed from Gamma-ray treated mini-tuber of Cvs. 'Obiaoturugo': (A) A dwarf non-climbing mutant; (B) Five stands of a dwarf mutant clone with erect non-climbing vegetation.

adequate genetic changes to allow for more efficient selection of desirable mutants. Thus, the Gamma-ray dose range from the results for mutation induction in the white yam, using mini-tubers was established to be 20 – 40Gy (GR₅₀ was 30Gy and LD₅₀ was 40Gy).

MV₂ yam lines with modified vegetative characteristic (Table 5, Fig. 1) were isolated.

Distinct lines with bunched and bushy vegetation, bunched with conical canopies and bushy with spreading vine branches were isolated. In these lines, vines had reduced lengths, and possessed comparatively shorter canopies. One of the genetic improvement objectives apart from high tuber yields, include the development of yam lines that may cropped for high yield without staking [2]. The characters associated with these dwarf mutants have proved stable over three generations.

Table 5. Lines isolated from irradiated mini-tubers with modified vegetative structure at the MV₂ generation

S/No	Line	Yield Per Stand (Kg)	Description
1.	10GyHR ₂ 009	0.10	Dwarf erect vegetation
2.	10GyHR ₄ 013	0.09	"
3.	10GyHR ₄ 014	0.10	"
4.	20GyHR ₃ 015	0.07	"
5.	H ₃₀ R ₂ 019	0.10	"
6.	H ₃₀ R ₃ 007	0.15	"
7.	H ₄₀ R ₄ 003	0.18	"
8.	H ₄₀ R ₄ 013	0.16	Bunchy, non-climbing
9.	H ₆₀ R ₃ 013	0.10	Erect vegetation
10.	H ₇₀ R ₂ 001	0.15	Non-climbing with spread vegetation
11.	H ₅₀ R ₃ 002	0.15	"
12.	T ₁₀ R ₁ 010	0.10	Erect with bunchy vegetation
13.	T ₄₀ R ₂ 002	0.09	Bunchy, non-climbing
14.	T ₂₀ R ₁ 013	0.17	Non-climbing, spreading.
15.	T ₇₀ R ₄ 001	0.05	Non-climbing, erect
16.	T ₃₀ R ₁ 002	0.14	Non-climbing, spreading
17.	T ₃₀ R ₄ 004	0.15	Non-climbing, spreading
18.	T ₆₀ R ₁ 003	0.27	Non-climbing, Spreading
19.	T ₅₀ R ₃ 001	0.10	Erect-dwarf
20.	H ₄₀ R ₄ 020	0.10	Erect-dwarf
21.	H ₅₀ R ₁ 004	0.20	Non-climbing, bunchy
22.	H ₃₀ R ₄ 011	0.06	Erect-dwarf
23.	H ₄₀ R ₃ 005	0.04	Erect-dwarf
24.	H ₄₀ R ₄ 015	0.21	Climbing, short canopy
25.	H ₄₀ R ₄ 014	0.28	Climbing, bunchy, short canopy
26.	Control	0.45	Normally climbing and staked

BIBLIOGRAPHY

1. F.A.O. (2006). F.A.O. Yearbook. F.A.O., Rome, Italy.
2. Onwueme, I.C. (1978). The tropical tuber crops: Yams, Cassava, Sweet Potato, Cocoyams. John Wiley and sons, New York. Pp. 234.
3. Coursey, D. G., Martin, F. W. The past and future of the yams as crop plants. Proc. 2nd Int. Symp. Trop. Root Tuber Crops. 87-90 (1970).
4. Waitt, A. W. Research on yam. Ann. Rep. Fed. Dept. Agric. Res. Nigeria, 1959-1961 (1961).
5. Doku, E.V. Yam in Ghana, Proc. 2nd Intern. Symp. Trop. Root Tuber Crops. Hawaii. 85-86 (1970).
6. Sadik, S., Okereke, O.U. A new approach to improvement of yam, *Dioscorea rotundata*. *Nature* **245**(5496), 134 (1975).
7. Okoli, O.O. Yam production from seeds. Prospects and problems. *Proc. Agric. Soc. Nigeria*. **12**, 6 (1975).
8. Ammirato, P. V. Yams. In: Handbook of Plant Cell Culture Vol. 33 Eds. Ammirato, P.V., Evans, D. A., Sharp, W. R. and Yamada, Y.) Macmillan Publishing Co. New York, p. 327-354 (1984).
9. IITA, Annual Report 1973 (1974).
10. IITA, Annual Report 1971 (1972).
11. IAEA, Improvement of root and tuber crops by induced mutations. IAEA – TECDOC-411 IAEA Vienna. p.15-7 (1987).
12. Nwachukwu, E.C., Ene, L.S.O., Mbanaso, E.N.A. Radiation sensitivity of two ginger varieties (*Zingiber officinale*, *Rosc.*) to gamma irradiation. *Der tropenlandwirt* **95**, 99-103 (1994).
13. Nwachukwu, E.C. Induced Mutations and *in-vitro* culture techniques in the improvement of the white guinea yam, *Dioscorea rotundata*, Poir. Ph.D Thesis University of Nigeria, Nsukka, Nigeria (2000).
14. Gaul, H. Mutagen effects in the first generation after seed treatment: plant injury and lethality. In: Manual on mutation Breeding, 2nd Ed. IAEA, Vienna, Tech. Rep. Series, 199 (1977).
15. Konzak, C.F., Michaelson, K. Selecting parents and handling the M₁-M₃ generations for the selection of mutants. In: Manual on mutation breeding, 2nd Ed. IAEA, Vienna, *Tech. Rep. Series* **199**, 125-138 (1977).
16. Vasudevan, K., Jos, J. S. Gamma-ray effects on yam *Dioscorea alata* L. and *D. esculenta* (LOUR) BURK.) *J. Root Crops* **18**, 94-98 (1992).
17. Brunner, H. Methods of induction of mutations. In: Advances in plant breeding methods. Eds. Canguli, P. K., Mandak, A.K., Oxford and IBH Publ. Co. New Delhi, India p.62 (1985).

CONCURRENT SESSION 9

Induced Mutations in Seed Crop Breeding (1)

Developing Herbicide-Tolerant Crops From Mutations

S Tan* & S J Bowe

Abstract

Several herbicide-tolerant crops have been developed and commercialized from herbicide-tolerant mutants obtained through chemical mutagenesis followed by herbicide selection or direct herbicide selection of spontaneous mutations. All mutations used in commercial herbicide-tolerant crops are derived from a single nucleotide substitution of genes that encode enzymes or proteins targeted by herbicides. The alleles of all commercial herbicide-tolerant mutations are incompletely-dominant except for the triazine-tolerant mutation.

Introduction

Herbicide-tolerant crops in combination with their corresponding herbicides are able to control many weeds that cannot be or are less effectively controlled with other means [1]. Commercial herbicide-tolerant crops developed from herbicide-tolerant mutants include imidazolinone-tolerant maize, rice, wheat, oilseed rape, sunflower, and lentil; sulfonylurea-tolerant soybean and sunflower; cyclohexanedione-tolerant maize; and triazine-tolerant oilseed rape [2].

Development of herbicide-tolerant mutants

Most of the herbicide-tolerant mutants were developed through chemical mutagenesis followed by herbicide selection [1]. Among the chemical mutagens, EMS was the most popular one. Several herbicide-tolerant mutants were also discovered through direct herbicide selection of spontaneous mutations [1]. Although gamma irradiation was also attempted in mutagenesis for herbicide tolerance, no commercial herbicide-tolerance trait has been developed by using this method [3].

Characterization of herbicide-tolerant mutations

All mutations used in commercial herbicide-tolerant crops are derived from a single nucleotide substitution of genes that encode enzymes or proteins targeted by herbicides. Imidazolinone-tolerant maize, rice, wheat, and oilseed rape have a gene variant encoding an altered aceto-hydroxyacid synthase (AHAS) with the S653N amino acid substitution [1]. Additionally, imidazolinone-tolerant maize and oilseed rape have an AHAS with the W574L amino acid substitution [1]. Imidazolinone-tolerant sunflower has been developed from the A205V AHAS gene mutation [1]. In contrast, sulfonylurea-tolerant sunflower selected from a farm field has an AHAS enzyme variant with the P197L amino acid substitution [4]. Similarly, sulfonylurea-tolerant soybean has a P197S AHAS gene mutation [5]. Sulfonylurea-tolerant sunflower from seed mutagenesis and imidazolinone-tolerant lentil are also derived from AHAS gene mutations [6, 7]. Cyclohexanedione-tolerant maize has an altered acetyl-CoA carboxylase with the I1781L amino acid substitution [8]. Triazine-tolerant oil seed rape possesses a *psbA* gene variant that encodes the D1 protein of photosynthesis with the S264G amino acid substitution [9].

Incorporation of herbicide-tolerant traits into elite varieties

To confer commercial tolerance to herbicides, some herbicide-tolerance alleles can be heterozygous, others need to be homozygous, and the rest must be stacked with another tolerance gene. The alleles of all commercial herbicide-tolerant mutations are incompletely-dominant and not pleiotropic except for the triazine-tolerant mutation which is inherited maternally and linked with several agronomic traits. The herbicide-tolerant trait can be incorporated in elite varieties through crossing of the elite variety with a trait donor.

BIBLIOGRAPHY

1. Tan, S. *et al.* Imidazolinone-tolerant crops: history, current status and future. *Pest Manag. Sci.* **61**, 246-257 (2005).
2. Duke, S.O. Taking stock of herbicide-resistant crops ten years after introduction. *Pest Manag. Sci.* **61**, 211-218 (2005).
3. Croughan, T.P. Herbicide resistant rice, *US patent (1998) 5773704*. <http://www.uspto.gov/patft/index.html>
4. Kolkman, J.M. *et al.* Acetohydroxyacid synthase mutations conferring resistance to imidazolinone or sulfonylurea herbicides in sunflower. *Theor. Appl. Genet.* **109**, 1147-1159 (2004).
5. Green, J. Review of glyphosate and ALS-inhibiting herbicide crop resistance and resistant weed management. *Weed Technol.* **21**, 547-558 (2007).
6. Gabard, J.M., Huby, J.P. Sulfonylurea-tolerant sunflower line M7. *US patent (2004) 6822146*. <http://www.uspto.gov/patft/index.html>
7. Slinkard, A.E. *et al.* Lentil plants having increased resistance to imidazolinone herbicides. *US patent (2007) 7232942*. <http://www.uspto.gov/patft/index.html>
8. Zagnitko, O. *et al.* An isoleucine/leucine residue in the carboxyltransferase domain of acetyl-CoA carboxylase is critical for interaction with aryloxyphenoxypropionate and cyclohexanedione inhibitors. *PNAS* **98**, 6617-6622 (2001).
9. Sundby, C. *et al.* Effects on photosystem II function, photoinhibition, and plant performance of the spontaneous mutation of serine-264 in the photosystem II reaction center D1 protein in triazine-resistant *Brassica napus* L. *Plant Physiol.* **103**, 105-113 (1993).

BASF Corporation, Research Triangle Park, NC, USA

* Corresponding author. E-mail: siyuan.tan@basf.com

Marker-assisted Backcrossing to Incorporate Two Low Phytate Alleles Into the Tennessee Soybean Cultivar 5601T

D Landau-Ellis* & V R Pantalone

Abstract

Development of low phytate soybean is favorable to the environment by reducing phosphorous loads to agricultural lands and surface waters. The trait also provides enhanced nutrition and metabolism for poultry and swine. Our source for the trait was a low phytate germplasm (CX1834-1-2) developed by the USDA and Purdue University through ethyl methanesulfonate (EMS) mutagenesis. The objective of this project was to develop a commercially acceptable, superior quality, high-yielding soybean cultivar with low seed phytate. In order to incorporate the low phytate trait into our regionally adapted soybean cultivar '5601T', we have combined a series of backcrosses with marker-assisted selection (MAS) at each backcross stage. Simple sequence repeat (SSR) markers have enabled us to i) transfer two recessive alleles governing the low phytate trait and ii) identify which specific individual backcross plants had DNA of the greatest commonality with the genome of the recurrent parent 5601T. We utilized two low-phytate SSR markers Satt237 (linkage group N) and Satt561 (linkage group L) for dual marker assisted selection for gene transfer of the low phytate trait. Molecular markers dispersed across the genome proved to be effective for facilitating genome recovery of the high-yielding 5601T recurrent parent every backcross generation. Chemical analyses confirmed that the low phytate trait was inherited in concert with the molecular markers. Thirty three lines homozygous for both low phytate recessive alleles have been planted in 2008 in a yield trial at the East Tennessee Research and Education Center in Knoxville, TN for field evaluation and seed production.

Introduction

The phosphorus in soybean seed is stored primarily as phytic acid or phytate [1]. Development of new cultivars with low phytate is important because phytate is of nutritional and environmental concern. Phytic acid can be anti-nutritional because it is a strong chelator of mineral nutrients and reduces the availability of divalent cations such as calcium, manganese, iron, magnesium and zinc. The phosphorus in phytate is non-bioavailable to monogastric animals such as poultry and swine [2].

Wilcox, *et al.* [3] isolated mutants with high inorganic phosphorus (Pi) and low phytic acid (*lpa*) phosphorus through ethyl methanesulfonate (EMS) mutagenesis. The germplasm CX1834-1-2 was developed from these mutant populations. Through segregation analysis, Oltmans, *et al.* [4] determined the inheritance of low-phytate phosphorous in soybean is controlled by recessive alleles *pha1* and *pha2* with duplicate dominant epistasis; both alleles must be present to obtain low-phytate seed.

Research by Walker, *et al.* [5] indicated that the simple sequence repeat (SSR) markers Satt237 on soybean linkage group N and Satt561 on linkage group L are associated with quantitative trait loci (QTL) for phytate level in soybean. Satt237 was linked to a major locus associated with seed phytate and Satt561 had a smaller effect on seed phytate concentration.

Our objective was to utilize these markers to facilitate *lpa* trait introgression from the non agronomic germplasm CX1834-1-2 into our regionally adapted and productive cultivar '5601T'.

5601T is a conventional (Maturity Group V) soybean cultivar developed by the Tennessee Agricultural Experiment Station and released in 2001 [6]. It was released because of its high yield throughout broad geographic regions of southern USA. It was the highest yielding line in the USDA Maturity Group V Regional tests for Tennessee and Kentucky for the years 2005, 2006, and 2007. It is currently used as a USDA check cultivar in the Southern Regional Uniform Tests. Because of its yield performance along with its somewhat higher protein content, it was an ideal line for transfer of the low phytate characteristic.

Materials and Methods

DNA Extractions

Three to five leaves were sampled from each plant. One leaf from each sample was pressed onto Whatman FTA® plant cards (Brentford, Middlesex, UK) and the remaining leaves were stored at 80°C. In order to identify double heterozygotes, we extracted samples from FTA cards according to Whatman instructions. Once we had identified the double heterozygotes we used Qiagen Plant DNeasy (Qiagen, Hilden, Germany) extractions for the corresponding stored leaf tissue to obtain a larger quantity of DNA from those individuals which would be submitted to analysis with a larger number of markers.

Polymerase Chain Reaction (PCR) amplification with SSR markers

Song, *et al.* [7] have made linkage analysis and more than 1,000 SSRs available to the soybean research community. These DNA markers serve as genetic landmarks interspersed throughout the 50,000 or more genes contained by the 20 chromosomes or linkage groups of the soybean genome. The markers on this linkage map can be used for marker-assisted selection.

PCR amplification was achieved with a ThermoHybaid multi-block system (Franklin, MA) with the following amplification conditions:

1 cycle	94°C for 5min
35 cycles	94°C denaturation 25sec, 48°C annealing 30sec, and 72°C extension for 30sec
1 cycle	72°C extension for 5min

Reverse primers were synthesized by Sigma Genosys custsvs@sial.com. Forward primers were synthesized by Sigma Proligo oligosupport-us@proligo.com and labeled with WellRed Dye. Our PCR protocol used HotMasterMix containing HotMaster Taq DNA Polymerase (5 Prime, Inc. Gaithersburg, MD)

Capillary electrophoresis

The Beckman CEQ™ 8800 Genetic Analysis System (Beckman Coulter, Fullerton, CA) was used to separate PCR products by capillary electrophoresis. Electropherograms are shown in **Figure 1**.

Soybean Breeding and Genetics Programme, Plant Science Department, 2431 Joe Johnson Drive, The University of Tennessee, Knoxville, Tennessee, 37996-4561 USA

* Corresponding author. E-mail: dellis@tennessee.edu

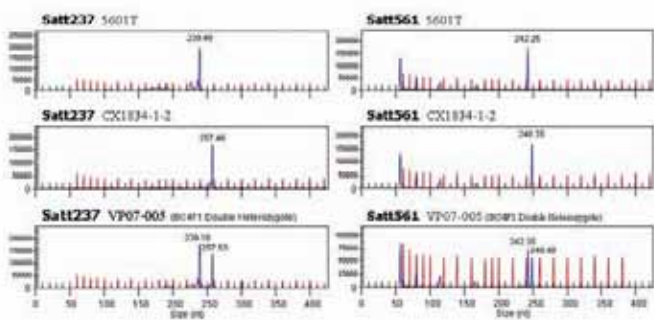

Figure 1 Separation of PCR products by size for the two markers associated with low phytate. The BC4F1 plant 005 is heterozygous for both Satt237 and Satt561.

AXB 2005 BC2F1 PLANT	Satt237 239nt = 5601T 257nt = CX1834-1-2	MSatt561 259nt = 5601T 265nt = CX1834-1-2	GENOTYPE 'A' = pha1 'B' = pha2
18 Plants	5601T	5601T	AABB
17 Plants	5601T	HETEROZYGOTE	AABb
22 Plants	HETEROZYGOTE	5601T	AaBB
19 Plants	HETEROZYGOTE	HETEROZYGOTE	AaBb

Colorimetric assays for inorganic phosphate (Pi) In the low phytate soybean lines developed by Wilcox, *et al.* [3], low phytic acid levels are inversely associated with an elevated level of Pi, which is easier to measure. We use a method of analysis adapted from Chen, *et al.* [8] and described by Raboy [9]. “Chen’s reagent” reacts with Pi to produce a blue color, and the intensity of the blue indicates the concentration of Pi in the extract solution. Therefore, samples which produce a darker blue color are from low-phytate seed.

Marker-assisted backcrossing to introgress the low phytate trait Our backcrossing strategy was to build upon the elite qualities of the recurrent parent 5601T by adding the low phytate trait. CX1834-1-2 was used as the pollen donor in our initial cross. The CX1834-1-2 germplasm was derived from a cross of ‘Athow’ (normal phytic acid levels) to M153-1-4-6-14, a selection from the *lpa* M153 mutant line by Wilcox, *et al.* [3].

First generation hybrid (BC1F1) plants were grown in a winter nursery in Isabela, Puerto Rico during winter/spring season of 2005. DNA from individual plants was collected and analyzed by capillary electrophoresis with the Beckman CEQ8800. BC1F1 individuals were identified from DNA selections to utilize for pollen transfer. Each selected donor contained the low phytate type alleles at both the molecular linkage group (MLG) N Satt237 locus and at the MLG L Satt561 locus in heterozygous form, thereby enabling dual marker assisted selection for gene transfer of the low phytate trait. A colorimetric assay, developed by Raboy, *et al.* [9] was used to measure inorganic phosphorous content among BC1F2 individuals in Knoxville, TN. Results of those tests confirmed that indeed the low phytate trait was inherited in concert with the molecular markers. This was important proof of concept that molecular markers tightly linked to the underlying QTL governing soybean seed phytate can be successfully utilized with a marker-assisted selection approach.

BC2F1 hybrids were grown in Knoxville, TN during summer 2005. DNA from each BC2F1 individual was isolated and analyzed at the Satt237 and Satt561 loci to identify low phytate genetic transmission. Seventy-six BC2F1 plants exhibited allelic segregation patterns at the Satt237 and Satt561 loci consistent with Chi-square expectations for a 1:1:1:1 inheritance pattern of gamete transmission from double-heterozygote parents (Table 1). Thus we verified that when molecular marker selection was

employed, genetic transfer of the low phytate loci continued to the BC2 generation.

BC2F1 individuals which proved to exist in the double-heterozygous state were screened for an array of polymorphic SSR markers spanning the soybean genome, in order to identify those individuals with greatest recurrent parent genome similarity.

The five best BC2F1 individuals, whose genetic similarities with the recurrent parent ranged from 87% to 93% were identified, and used in hybridizations with the recurrent parent to form BC3F1 hybrid seeds. Each selected donor contained one copy of the low phytate type allele at both the MLG N Satt237 locus and at the MLG L Satt561 locus, enabling dual marker assisted selection for gene transfer of the low phytate trait to proceed.

DNA analyses of putative BC3F1 seeds grown in Knoxville TN in 2006 revealed that a fourth backcross would be needed to recover a strong recurrent parent genome. The four best individuals which were confirmed double heterozygotes for the two low phytate loci and which molecular markers showed simultaneously had the greatest DNA homology with 5601T (recurrent parent) were selected as donors to form the BC4F1 generation.

Seeds of soybean plants from earlier generations (BC1, BC2, BC3) of this project were analyzed for phosphorous content in order to identify those that expressed the low phytate trait, following DNA molecular marker assisted trait selection. All generation lines were planted in rows at the East Tennessee Research and Education Center in Knoxville, TN for field evaluation and seed production. Chemical analyses confirmed that the low phytate trait was inherited in concert with the molecular markers.

LINKAGE GROUPS		N	L	A2	D2	F	G	K	L	N	O	O	SCORE
♀	♂	BC4F1	Satt 237	Satt 237	Satt 237	Satt 237	Satt 237	Satt 237	Satt 237	Satt 237	Satt 237	Satt 237	
5601T	91-10	001	HET	HET	0	0	1	0	0	0	0	0	1
5601T	91-10	002	HET	HET	0	.	1	1	0	0	.	0	2
5601T	91-10	005	HET	HET	0	0	0	0	0	0	0	0	0
5601T	91-10	009	HET	HET	0	0	1	0	0	0	.	0	1
5601T	91-12	014	HET	HET	0	0	1	0	0	1	0	0	2
5601T	91-12	017	HET	HET	1	0	0	0	0	.	0	0	1
5601T	91-21	029	HET	HET	0	0	0	0	0	0	0	0	0
5601T	91-24	030	HET	HET	0	0	0	0	0	0	1	1	2
5601T	90-19	052	HET	HET	1	0	0	.	1	0	0	0	2
5601T	90-19	054	HET	HET	.	0	0	0	.	0	0	1	1
5601T	90-22	062	HET	HET	0	0	0	0	1	0	0	1	2
5601T	90-22	063	HET	HET	0	0	0	0	0	0	0	1	1
5601T	90-22	064	HET	HET	0	0	0	0	1	0	0	1	2
5601T	90-23	072	HET	HET	0	0	0	.	1	0	0	1	3
5601T	90-23	073	HET	HET	1	.	0	0	.	0	0	1	2

SCORE: summation over linkage groups, where 1=Heterozygote, 0=5601T allele. We expect plants with the lowest score sum to have retained more of the 5601T genome

Newly created BC4F1 hybrid seeds were grown in a lighted nursery in Puerto Rico during the winter of 2006-2007. Leaf tissue was collected from each BC4F1 individual plant and DNA extracted to confirm true double-hybrids at the low-phytate loci, using molecular markers Satt237 and Satt561 via capillary gel electrophoresis on our Beckman-Coulter CEQ 8800 genetic analysis system. This enabled identification

of 15 double heterozygotes in the 5601T genetic background. Then, SSR markers (dispersed throughout the genome) which were polymorphic between the recurrent parent and the donor were screened to determine genomic similarity with the 5601T genome (**Table 2**). Two BC₄F₁ plants (Plant 005 from BC₃F₁ pollen donor 91-10 and Plant 029 from BC₃F₁ pollen donor 91-21) showed perfect genetic identity with the recurrent parent genome.

Summary

All 15 BC₄F₁ plants, from the 2006-2007 Puerto Rico winter nursery which were double heterozygotes for the two SSR markers Satt237 and Satt561, were advanced in BC₄F₂ rows grown in Knoxville the summer of 2007. Single plants were pulled from all progeny rows originating from plant 005 and 029 and BC₄F_{2,3} seed was harvested. Three to five seed from each plant was analyzed for phytate by the colorimetric assay. Seeds with high inorganic P and low phytate produced a solution that was dark blue in color. Seeds from these lines were sent to our winter nursery in Homestead Florida for seed increase in the 2007-2008 season. Seed was returned to us as BC₄F_{2,4} lines which are currently in a yield trial at the East Tennessee Research and Education Center in Knoxville, TN.

In summary, the molecular markers Satt237 and Satt561 proved to be effective for dual marker assisted selection for gene transfer of two recessive genes which collectively confer the low phytate trait, as evidenced by chemical analysis of seed phosphorous in selected progeny. The original donor line (CX1834-1-2) is poorly agronomic: it suffers from significant losses in seed germination, flowers and sets pods too early in southern USA latitudes, and produces low seed yields. A strategy was needed to rapidly transfer the donor's low phytate trait to a high-yielding genetic background. Molecular markers dispersed across the genome proved to be effective for facilitating genome recovery of the high-yielding 5601T recurrent parent every backcross generation. By the BC₄ stage we have fully captured the recurrent parent genome while simultaneously confirming the presence of both low phytate loci.

ACKNOWLEDGMENTS

The Tennessee Agricultural Experiment Station, the Consortium for Plant Biotechnology Research, the United Soybean Board, the Tennessee Soybean Promotion Board, and UniSouth Genetics, Inc. are gratefully acknowledged for their support of this project.

BIBLIOGRAPHY

1. Raboy, V., Dickinson, D.B., Below F.E. Variation in seed total P, phytic acid, zinc, calcium, magnesium, and protein among lines of Glycine max, and G. soja. *Crop Sci.* **24**, 431-434 (1984).
2. Brinch-Pedersen, H., Sørensen, L.D., Holm, P.B. Engineering crop plants: getting a handle on phosphate. *Trends Plant Sci.* **7**, 118-125 (2002).
3. Wilcox, J.R., Premachandra, G.S., Young, K.A., Raboy, V. Isolation of high seed inorganic P, low-phytate soybean mutant. *Crop Sci.* **40**, 1601-1611 (2000).
4. Oltmans, S.E., Fehr, W.R., Welke, G.A., Cianzio, S.R. Inheritance of low-phytate phosphorus in soybean. *Crop Sci.* **44**, 433-435 (2004).
5. Walker, D.R., Scaboo, A.M., Pantalone, V.R., Wilcox, J.R., Boerma, H.R. Genetic Mapping of Loci Associated with Seed Phytic Acid Content in CX1834-1-2 Soybean. *Crop Sci.* **46**, 390-397 (2006).
6. Pantalone, V.R., Allen, F.L., Landau-Ellis, D. Registration of '5601T' soybean. *Crop Sci.* **43**, 1123-1124 (2003).
7. Song, Q.J., Marek, L.F., Shoemaker, R.C., Lark, K.G., Concibido, V.C., Delannay, X., Specht, J.E., Cregan, P.B. A new integrated genetic linkage map of the soybean. *Theor Appl Genet.* **109**, 122-128 (2004).
8. Chen, P.S., Toribara, T.Y., Warner H. Microdeterminations of Phosphorous. *Anal. Chem.* **28**, 1756-1758 (1956).
9. Raboy, V. Progress in breeding low phytate crops. *J. Nutr.* **32**, 503S-507S (2002).

The Improvement of TAEK-Sağel Chickpea (*Cicer arietinum* L.) Mutant Variety in Turkey

Z Sağel*, M I Tutluer, H Peşkiricioğlu, K Y Kantoğlu & B Kunter

Abstract

This research is aimed to improve chickpea varieties that are well-adapted to chickpea growing areas, resistant to cold, suitable to machinery harvest type, exhibit high yield and high protein content, bigger seed size, resistance to antracnose and other diseases and pests, and improved quality characteristics. This chickpea breeding project was started with ILC 482, Akçin-91 and AK 71114 parental varieties and eight different gamma radiation dose rates between 50-400Gy were used. After following mutation breeding steps, location experiments started for testing yield and quality characteristics in 2004. According to the results of these experiments two outstanding mutant lines were given for registration. One of them was registered TAEK Sağel in 2006. In this paper, the yield and quality characteristics of 'TAEK-Sağel' mutant chickpea variety are discussed. It was found that this mutant has 186 kg/da average yield with 23% seed protein content. In addition, its cooking time was shorter than the others (37 minutes).

Introduction

Chickpea is an important legume in Turkey. Turkey is one of the most important legume gene centers in the world [1]. The most widely known characteristics of chickpea are that they are an important vegetable protein source used in human and animal nutrition. The dry seeds of chickpea, have two to three times more protein than traditional wheat. In addition, it has a high carbohydrate content and is valued as a important energy source. Chickpea is also very rich in some vitamins and minerals. In the plant breeding, mutation induction has become an effective way of supplementing existing germplasm and improving cultivars. Many successful examples of mutation induction have proved that mutation breeding is an effective and important approach to legume improvement. The induced mutation technique in chickpea has proved successful and good results have been attained. Realizing the potential of induced mutations, a mutation-breeding programme was initiated at the Nuclear Agriculture Section of the Saraykoy Nuclear Research and Training Center in 1994. The purpose of the study was to obtain high-yielding chickpea varieties with large seeds, good cooking quality and high protein content.

Materials and Methods

Seeds of the local chickpea varieties (Ak-71114, Akcin and ILC482) were irradiated with 0 (Control), 50, 100, 150, 200, 250, 300, 350 and 400Gy of Gamma -rays by using of ⁶⁰Co source [2-3]. One thousand seeds per treatment were sown in the field for the M₁ generation. At maturity, 3,500 single plants were harvested and 20 seeds taken from each M₁ plant and planted in the following season. During plant growth, mutants of the desired traits (earliness, yield per plant, plant height, first pot height and Ascochyta blight (*Ascochyta rabie*) resistance) were identified and isolated. Two thousand, five hundred and twenty desirable

M₂ mutants were selected and grown in progeny rows as the M₃ generation. The protein content was analyzed for the M₃ and M₄ seeds. In the M₃ generation, preliminary yield trials were conducted and after field observation, quality criteria (such as grain size, grain type, cooking time and protein content) were analyzed, and 12 mutant lines were selected. The mutant and control varieties were performed at two locations (Saraykoy and Haymana) for two years (M₇, M₈). Randomized complete block design (RCBD) with three replications was used for field trials. All data of investigated characteristics such as seed yield, grain size, grain type, first pot height, Ascochyta blight (*Ascochyta rabie*), cooking and protein content were analyzed statistically [4]. After these experiments, 2 promising mutant lines were selected and given to the Directorate of Seed Registration and Certification Center for official registration. These two mutants were tested for two years (2004 and 2005), in five different locations of Turkey (Ankara, Esenboga, Haymana, Konya and Eskişehir) by the Seed Registration and Certification Center.

Results and Discussion

Laboratory experiments

The effects of different doses of gamma radiation on seedling height in M₁ are presented **Table 1** and **Fig. 1**.

As compared to the control (untreated), seedling height was reduced in the irradiated material. Depending on the increasing dose rates, the seedling height was reduced from 15,7 cm to 27 cm for ILC482 and from 15,8 cm to 4,7 cm for AK71114. Laboratory experiments showed that the seedling height decreased when treated with increasing radiation doses [5]. The growth reduction doses (GR-50) were determined as 210Gy and 240Gy for ILC 482 and AK71114, respectively [6].

Field experiments

During plant growth in the field, mutants with the desired traits (earliness, yield per plant, plant height, first pot height and Ascochyta blight (*Ascochyta rabie*) resistance) were identified and isolated. About 2,520 desirable M₂ mutants were selected and grown in progeny rows as the M₃ generation. The protein content was analyzed for the M₃ and M₄ seeds. In M₃ generation, preliminary yield trials were conducted and after field observation, and quality criteria (grain size, grain type, cooking, protein) analyzed, and a total of 12 mutant lines were selected [7].

M₇ and M₈ generation were conducted with five promising mutant lines and control varieties (standard), at two locations (Saraykoy and Haymana). The results of these experiments were presented in **Table 2**. TAEK Sağel and TAEK Sağel-10 mutants gave the highest seed yield (about 220 kg/da) in both locations.

Morphological, agronomic and quality characteristics of the chickpea mutant lines are shown in **Table 3** and **Table 4**.

Registration experiments

Seed yield and seed quality results from Directorate of Seed Registration and Certification Center, are given in **Table 5**, **Table 6** and **Table 7**.

TAEA, Saraykoy Nuclear Research and Training Center, Nuclear Agriculture Section, Saraykoy, Ankara, Turkey

* Corresponding author. E-mail: zafer.sagel@taek.gov.tr

TAEK Sağel and TAEK Sağel-10 mutant lines gave a good performance in Ankara, Konya and Eskişehir. The average seed yield was 186 kg/da for these mutants (Table 5).

TAEK Sağel mutant line had 23.2 % protein content. This mutant has 41g dry weight, 85g wet weight, 45g/seed water uptake capacity, 1.15 % water uptake index, 81ml dry volume, 0.47ml/seed swelling capacity and 2.52 % swelling index. Cooking time was lower (37 minutes) than the others (Table 6).

In addition, the TAEK Sağel mutant line had a good stability as yield performance in different locations. Error mean square for this mutant was 171.2 and was much lower than the others (Table 7).

After two years of registration experiments, one of outstanding mutants was officially released as mutant chickpea variety under the name TAEK SAGEL in 2006.

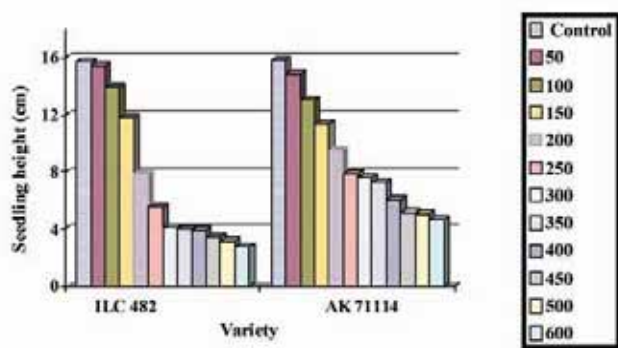

Figure 1 Effect of gamma radiation on seedling height in M_1 .

Table 1. Effect of gamma radiation on seedling height in M_1

Chickpea variety	Dose(Gray)											
	Control	50	100	150	200	250	300	350	400	450	500	600
ILC 482	15,7	15,5	13,9	11,8	7,9	5,5	4,1	3,9	3,9	3,4	3,1	2,7
AK 71114	15,8	14,9	13,0	11,46	9,5	7,8	7,6	7,2	6,1	5,1	5,0	4,6

Table 2. Chickpea yield results in two locations (2002-2003)

Variety	Dose (Gray)	Average yield (kg/da)		
		Sarayköy (2002)	Sarayköy (2003)	Haymana (2003)
TAEK SAGEL	150	228.2 ab	239.6 a	193.2 a
TAEK SAGEL 10	100	236.8 a	231.4 ab	191.1 a
TAEK 8	200	202.9 cd	226.4 b	178.6 a
TAEK 7	400	171.3 f	213.2 c	175.6 b
TAEK 6	250	189.9 de	207.8 c	173.6 b
AK-71114 (ST)	St	176.3 ef	212.5 c	175.0 b
AKÇ N-91 (ST)	St	166.7 f	212.8 c	176.8 b
ILC 482 (ST)	St	217.1 bc	177.5 d	188.2 b
F		**	**	**
CV (%)		13.73	8.87	4.46
LCD		4.46	14.92	7.75

*In a column, means followed by a common letter are not significantly different at the 0.05 P.

Table 3. Morphological characteristics of chickpea (2003)

Variety	Dose (Gy)	% 50 flower (days)	Maturity (days)	Plant height (cm)	First pot height (cm)	No of branches (plant)	No of pods (plant)	No of seeds (plant)	Growth habit (1-3)	Ascochyta blight (1-9)	100 Seed weight (g)	Yield (kg/da)
TAEK SAGEL	150	69	96	46,3	16,9	2-4	33,2	31,8	1	3	47,2	239,6 a
TAEK SAGEL-10	100	68	98	45,5	16,3	2-4	32,9	32,3	1	3	46,4	231,4 ab
TAEK-8	200	67	96	44,9	16,7	2-4	32,0	30,1	1	4	44,5	226,4 b
TAEK-7	400	68	97	44,4	17,1	2-4	29,6	28,8	1	5	44,0	213,2 c
TAEK-6	250	69	99	44,9	16,9	2-3	31,0	30,5	1	5	40,3	207,8 c
AK-71114 (ST)	St	66	98	44,4	16,2	2-3	30,0	29,0	1	5	40,9	212,5 c
AKÇIN 91 (ST)	St	65	95	44,7	15,9	3-4	33,1	32,3	1	5	40,1	212,8 c
ILC-482 (ST)	St	63	97	45,8	18,1	3-5	42,2	37,4	2	5	32,3	177,5 d

*In a column, means followed by a common letter are not significantly different at the 0.05 P.

Table 4. Quality characteristics of the chickpea mutants (2003)

Variety	Dry weight (g)	Wet weight (g)	Water uptake capacity (g/seed)	Water uptake index (%)	Dry volume (ml)	Wet volume (ml)	Swelling capacity (ml/seed)	Swelling index (%)	Cooking time (min)	Protein (%)
TAEK SAGEL	46,4	97,3	0.51	1.10	90	195	0.55	2.37	37	23.2
TAEK SAGEL-10	48,4	100,1	0.52	1.07	89	187	0.48	2.24	45	23.6
TAEK-8	46,1	95,8	0.49	1.08	85	188	0.53	2.50	38	22.9
TAEK-7	44,5	92,5	0.48	1.08	84	188	0.54	2.60	39	21.2
TAEK-6	40,1	84,4	0.44	1.11	80	175	0.45	2.51	39	21.7
AK-71114 (st)	43,1	88,8	0.46	1.06	81	182	0.50	2.58	50	23.0
AKÇIN 91 (st)	41,4	84,3	0.43	1.04	83	183	0.50	2.53	45	21.4
ILC482 (st)	32,8	68,3	0.35	1.08	76	168	0.43	2.66	55	22.3
GÖKÇE (st)	44,2	89,5	0.45	1.03	83	188	0.55	2.65	51	21.3

Table 5. Chickpea registration experiment results (2004-2005)

Variety	2004			Konya		Eskisehir		Average Yield (kg/da)
	Ankara 2004	Esenboga 2005	Haymana 2005	2004	2005	2004	2005	
TAEK SAGEL	213.3	196.7	204.6	166.9	154.9	212.2	154.5	186.7
TAEK SAGEL -10	200,6	194,7	249,8	170,1	149,3	213,3	125,2	186,2
AKN 291	157,4	157,4	197,3	145,8	108,4	167,6	94,9	147,0
Uzunlu 99 (st)	163,2	118,7	136,0	102,4	92,4	163,4	108,1	126,3
Gökçe (st)	213,4	199,0	168,2	167,7	125,6	189,4	156,5	174,3
Akçin 91 (st)	179,2	173,1	275,9	137,8	115,4	160,6	132,9	167,8
Canitez 87 (st)	200,2	159,3	203,9	89,2	115,8	183,3	159,7	158,8
F								**
CV (%)								10.7
LSD								9.3

Table 6. Quality characteristics of the chickpea mutants

Variety	Dry weight (g)	Wet weight (g)	Water uptake capacity (g/seed)	Water uptake index (%)	Dry volume (ml)	Wet volume (ml)	Swelling capacity (ml/seed)	Swelling index (%)	Cooking time (min)
TAEK SAGEL	41	85	0.45	1.15	81	178	0.47	2.52	37
TAEK SAGEL-10	43	90	0.47	1.13	82	181	0.49	2.53	48
AKN 291	46	99	0.53	1.14	86	189	0.53	2.47	48
Uzunlu 99 (st)	43	91	0.48	1.16	82	182	0.50	2.56	45
Gökçe (st)	40	84	0.44	1.09	81	175	0.44	2.42	54
Akçin 91 (st)	44	91	0.47	1.11	83	182	0.49	2.48	53
Canitez 87 (st)	47	97	0.50	1.04	86	185	0.49	2.36	55

Table 7. Chickpea registration experiment some stability parameters

Variety	Yield (kg/da)	%	b	a	R ²	%CV	Error mean square	
TAEK SAGEL	186.7	118.1	0.997	0.150	8.5	0.89	7.9	171.2
TAEK SAGEL-10	182.2	115.2	1.424	0.220	-60.3	0.89	11.2	340.9
AKN 291	147.0		0.924	0.208	0.9	0.80	11.7	298.9
Uzunlu 99 (st)	126.3		0.665	0.234	21.1	0.62	15.4	377.8
Gökçe (st)	174.3		0.604	0.276	78.9	0.49	13.2	525.5
Akçin 91 (st)	167.8		1.379	0.326	-50.2	0.78	16.1	730.7
Canitez 87 (st)	158.8		1.069	0.302	-10.4	0.71	15.8	631.7
Std. Average Yield	156.8							
Gen. Average Yield	158.1	100.0						

BIBLIOGRAPHY

- Eser, D. Türkiye Nohut ve Mercimek Tarımının Durumu, Uluslararası Nohut ve Mercimek Sempozyumu. 101-108 (1988).
- Constantin, M.J., Klobe, W.D. Skold, L.N. Effects Of Physical and Chemical Mutagens on Survival, Growth and Seed Yield of Soybean. *Crop. Sci.* **16**, 49-52 (1976).
- Conger, B.V., Konzak, L.F., Nilan, R.A. Radiation Sensitivity and modifying factors. In: *Manual on Mutation Breeding*. Technical Reports Series. No.119, IAEA, 40-43 (1977).
- Düzgünes, O. Bilimsel Arastur-malarda Istatistik. Ege Üniv. Yayinlari, Izmir, 375 (1963).
- Sagel, Z., Ilisulu, K. Farklı radyasyon dozlarının Calland ve Mitchell soya çeşitlerinin çeşitli karakterleri üzerine etkisi, I. Ulusal Nükleer Tarım Hayvancılık Kongresi, 13-15, Eylül 1990, Van.
- Sagel, Z. Calland Ve Mitchell Soya Çeşitlerinde Gama Radyasyonu Uygulamasından Sonra ED50 ve LD50 Degerinin Belirlenmesi. *Tarla Bitkileri Merkez Arastırma Enstitüsü Dergisi*. **3**, 113-129 (1994).
- Williams, P., El-Haramein, F.J., Nakkoul, H., Rihaawi, S. *Crop Quality Evaluation Methods and Guidelines*. ICARDA, April, 1986, p.142.

Development of *B. Napus* Canola Quality Varieties Suitable for Indian Agro-climatic Conditions by Induced Mutations

S P Landge¹, Y Y Barve^{2*}, R K Gupta², S S Bhaduria², R P Thakre¹ & S E Pawar¹

Abstract

In mutation experiments, dry seed and presoaked seeds of canola quality 'Westar' were used with different doses / concentrations of Gamma-rays and chemical mutagens EMS and SA. Among several morphological mutants, 11 early maturing mutants were identified. The maturity of these mutants ranged from 90-15 days as against 169 days of Westar in Central India. The maturity of mutants NUDB-38 and NUDB-26-11 was 107 and 105 days respectively. These mutants were further evaluated for their yield and agronomical characters along with non-canola quality *B. napus* checks GSL-1 and *B. juncea* varieties Pusa Bold and Varuna. NUDB-38 has shown 33% superior yield performance over check variety GSL-1 (non-canola quality) and the oil yield was comparable with *B. juncea* national check variety Varuna in Zone II. Where as NUDB-26-11 was comparable (2% higher) with gobhi sarson check GSL-1 and it has given 24.6% higher yield over *B. juncea* check variety Varuna in Zone I under different agroclimatic conditions in the national testing (Indian Council for Agriculture Research) where *B. napus* is grown. Mutant NUDB-38 has been granted US patent (patent No. US 6706953 B2 dated March 16th, 2004) for its early maturity and high yield potential. Mutant NUDB-26-11 was identified for release for Zone I by the All India Coordinated Research Project on Rapeseed Mustard during 2007.

Introduction

Brassica napus (L) commonly known as rapeseed (or 'gobhi sarson' in India), is grown in Europe, Canada, China, Australia, northwestern parts of the USA, and a few other countries. The development of canola quality *B. napus* varieties in early 1980's, revolutionized the Brassica seed industries thus making available nutritionally superior quality oil for human consumption and quality seed meal for animals. 'Tower' was first canola quality *B. napus* variety released in Canada [1]. The cultivation of *B. napus* in India is restricted to few states in northwestern region, which has a longer winter. The exotic *B. napus* varieties introduced in the country were not commercially successful due to their late maturity and poor seed yield. Later, non-canola quality variety GSL-1 was released in Punjab during 1984-85, which is used as national check in coordinated national trials. Fourteen new Brassica varieties have been developed using Gamma-rays, X-rays, EMS, DMS, and MNH for early maturity, high yield, cold tolerance, height, disease resistance, oil content and altered fatty acid composition [2]. The present investigation was initiated at RTM Nagpur University by Late Dr. A. S. Khalatkar on induction of mutations in *B. napus* in cv Westar (canola quality), with the objective of inducing early maturing mutants with high yield potential suitable for commercial cultivation for Indian agro-climatic conditions.

Materials and Methods

In mutation experiments, dry and presoaked seeds were used with different doses / concentrations of Gamma-rays and chemical mutagens EMS

and SA. The effectiveness and efficiency of these mutagens were studied in M_1 generation using different parameters. Several mutations affecting different morphological and biochemical characters were identified. Among these, 11 early flowering mutants (38-49 days) as compared to variety Westar (75 days) were identified. The maturity of these mutants ranged from 90 -115 days, as opposed to 169 days of Westar in Central India.

These mutants were further evaluated for their yield and agronomical characters along with non canola quality *B. napus* checks GSL-1 and *B. juncea* varieties Pusa Bold and Varuna under different agroclimatic conditions in the national testing (Indian Council for Agriculture Research) programme in Zone II and Zone I where *B. napus* is grown.

Results and Discussion

Induction of earliness has been most important objective of mutation breeding in several crops. Early maturing mutants in rice [3], castor [4], and soybean [5] have been released as varieties for commercial cultivation worldwide. Early maturing mung bean mutant variety TAP-7 has helped bring a larger area under multiple cropping systems in specific ecological condition [6].

In the present study, out of the 11 early flowering and maturing mutants, in M_2 , three mutants were obtained after being presoaked in water for 12 hours and 6 hours in 0.06% SA treatment. It flowered in 40-51 days. The oil and seed quality of these mutants was similar to that of Westar. Their breeding behavior was studied in M_3 and M_4 . The data presented in **Table 1** shows the ancillary and biochemical characters of these three selected mutants in M_3 against canola quality *B. napus* check HPN-3 and non-canola quality *B. juncea* checks Pusa Bold. Mutant 69 was earliest to flower but yielded less than other two mutants. Mutant 38 and Mutant 26-11 gave 65% and 55% higher yield as compared to canola quality check HPN-3 respectively. These two mutants were later renamed as NUDB-38 and NUDB-26-11 respectively.

Table 1. Ancillary and biochemical characters of mutants in initial trial in M_3 generation at Nagpur (Central India).

Selection/ Variety	Plant height	50% Flowering (Days)	Maturity (Days)	100 seed wt (g)	Oil content (%)	Glucosinolate By Tes-tape	Erucic acid (%)	Yield (Kg/ha)
Mutant-69	133.2 ± 1.95	40.25 ± 0.75	102.75 ± 1.31	0.368 ± 0.01	41.87 ± 0.31	(-)	0	659.16
Mutant-38	141.3 ± 3.07	50.75 ± 0.62	115.25 ± 0.85	0.409 ± 0.01	40.81 ± 0.39	(-)	0	850.74
Mutant-26-11	151.6 ± 2.82	51.25 ± 1.03	112.00 ± 1.29	0.367 ± 0.006	42.06 ± 0.34	(-)	0	799.81
HPN-3 (C)	162.9 ± 2.96	62.25 ± 0.47	127.25 ± 1.10	0.312 ± 0.01	40.23 ± 0.74	(-)	0	515.2
Pusa Bold (C)	175.7 ± 3.44	53.00 ± 1.08	112.25 ± 1.43	0.527 ± 0.02	37.68 ± 0.37	(4+)	46.7	1079.8
Varuna (C)	168.8 ± 2.92	52.75 ± 0.85	112.75 ± 0.62	0.493 ± 0.01	37.65 ± 0.33	(4+)	47.97	907.7

¹ Department of Botany, RTM Nagpur University Campus, Amravati Road, Nagpur 440033 India

² Dhara Vegetable Oil & Foods Co. Ltd. NDDB Campus, Anand 388001 India

* Corresponding author. E-mail: yoganandbarve@gmail.com

Yield evaluation of NUDB-38

Mutant NUDB-38 was evaluated in the All India Coordinated Research Project on rapeseed Mustard in Zone II during 2000-01 to 2002-03. The maturity of NUDB-38 in Zone II was 149 days, which was comparable to non-canola quality *B. napus* national check GSL 1 (153 days). It has shown 33% superior yield performance over check variety GSL-1 (Table 2) and the oil yield was comparable with *B. juncea* national check variety Varuna.

US patent: Mutant NUDB-38 has been granted US patent (patent No. US 6706953 B2; dated March 16th, 2004) for its canola quality, early maturity and high yield potential.

Table 2. Mean performance of mutant NUDB-38 in the All India Coordinated Research Project on rapeseed mustard in Zone II during 2000-01 and 2002-03

Variety/ Strain	Yield (Kg/ ha)	% Increase over GSL-1	% Increase over Varuna	Oil yield (Kg/ha)	Oil content (%)	Maturity (days)	Erucic acid (%)	Glucosinolate (µmole/g defatted meal)
NUDB-38	1323 (13)	32.96	-2.6	521	39.2	149	0.9	21.96
GSL-1	995 (9)			372	38.6	153	40.13	193.90
Varuna (C)	1358 (13)			512	38.5	149	49.9	

*Figures in parenthesis are total n°. of locations

Yield evaluation of NUDB-26-11

Mutant NUDB-26-11 was also evaluated in the All India Coordinated Research Project on Rapeseed Mustard in Zone I during 2001-02 to 2005-06. The maturity of NUDB-26-11 was 154 days in Zone I, which was comparable to national check GSL 1 (157 days) (Table No. 3). The yield performance of NUDB-26-11 was comparable (2% higher) with non canola quality gobhi sarson check GSL-1 and it has given 24.6% higher yield over *B. juncea* check variety Varuna in Zone I.

Release of variety NUDB-26-11: Mutant NUDB-26-11 has been identified for release for Zone I by the All India Coordinated Research Project on Rapeseed Mustard during 2007. The release proposal has been submitted for notification.

Table 3. Mean performance of mutant NUDB-26-11 in the All India Coordinated Research Project on rapeseed mustard in Zone I during 2001-02 and 2005-06

Variety/Strain	Yield (Kg/ha)	% Increase	Oil content (%)	Days to maturity	Erucic acid (%)	Glucosinolate (µmole/g defatted meal)
NUDB-26.11	1145 (9)	-	38.7	154	1.11	25.53
GSL-1	1120 (9)	2.2	40.7	157	42.06	68.27
Varuna (C)	863(8)	24.6	39.5	153	49.90	85.07

*Figures in parenthesis are total no. of locations

and NUDB-26-11 has been identified for release for Zone I by the All India Coordinated Research Project on Rapeseed Mustard during 2007. Both these mutants have given superior/ equal yield as compared to non-canola quality check GSL-1.

ACKNOWLEDGEMENTS

We are thankful to National Dairy Development Board, Anand and its wholly owned subsidiary M/s Dhara Vegetable Oil & Foods Co. Ltd. Anand (Gujarat) India for financial support for the present investigation.

BIBLIOGRAPHY

1. Stefansson, B.R., Kondra, Z.P. Tower summer rape. *Can. J. Muta. Sci.* **55**, 343-344 (1975).
2. Bhatia, C.R. *et al.* Oil seed cultivars developed from induced mutations altering fatty acid composition. *Mutation Breeding Review* **11**, 1-36 (1999).
3. Wang, L.Q. Induced mutations for crop improvement in China (Proc. IAEA Symp. on plant Mutation Breeding for Crop Improvement. June 18-22, 1990) IAEA, Vienna, Vol. I. p.9-32 (1991).
4. Ankineedu, G. *et al.* Effect of fast neutrons and Gamma-rays on castor. *Indian J. Genet.* **28**, 31-39 (1968).
5. Kawai, T., Amano, E. Mutation breeding in Japan. (Proc. IAEA Symp. on plant Mutation Breeding for Crop Improvement. June 18-22, 1990). IAEA, Vienna, Vol. I. p.47-218 (1991).
6. Pawar, S.E. *et al.* Use of induced mutations in the breeding of pulse crops. (Proc. IAEA Symp. On Plant Mutation Breeding for Crop Improvement. June 18-22, 1990) Vol. I. IAEA. Vienna, p. 413-418 (1991).

Conclusion

These studies have indicated that mutation experiments with specific objectives can result in developing varieties suitable for specific regions with high yield potential. Early maturing mutant NUDB-38 has been granted US patent (patent No. US 6706953 B2; dated March 16th, 2004)

CONCURRENT SESSION 10

Induced Mutations in Seed Crop Breeding (2)

A *UGPase1*-blocked Male Sterility Mutant and Its Possible Use in Hybrid Seed Production of Rice

H J Koh* & M O Woo

Abstract

A rice genic male-sterile mutant was induced by chemical mutagenesis using N-methyl-N-nitrosourea, which had a pleiotropic effect on chalky endosperm. The mutant gene, *ms-h*, was isolated through a map-based cloning approach. The suppression of UGPase activity, caused by a splicing error at the 3' splice junction of the 14th intron of the *UDP-glucose pyrophosphorylase 1* (*UGPase1*; EC 2.7.7.9) gene, was the cause of male sterility. This was confirmed by both RNAi and complementation-transgenic experiments. The endosperm of the mutant had more roundish and smaller starch granules, a higher frequency of long glucose chain amylose, higher ratio of Fr. III to Fr. II chains, and shorter branching of amylopectin than the wild type parent. A hybrid seed production system was proposed using the pleiotropic effect of *UGPase1* gene on male-sterility and chalky endosperm. Relatively low density of chalky seeds may facilitate the early detection of male-sterile seeds in segregating populations prior to sowing by density-gradient method.

Introduction

Male-sterile (MS) mutants have been reported in many species of higher plants as the result of both spontaneous and induced mutations [1]. Male sterility is conditioned by either cytoplasm-specific (CMS) or genetic male sterility (GMS) genes. In rice, male sterility is classified into four major groups: cytoplasmic male sterility (CMS), photoperiod-sensitive genic male sterility (PGMS), thermo-sensitive genic male sterility (TGMS) and other genic male sterilities [2]. CMS and PGMS/TGMS have been used for hybrid seed production. However, genic MS lines have hardly been used due to the difficulty in purifying MS plants in segregating mixtures of MS and heterozygous plants. Several efforts have been made to develop a genic male-sterility system involving a closely linked phenotypic marker so that the male-sterile plants could be readily distinguished from normal plants in segregating populations. Initially, it was envisioned to produce F₁ seeds using the linked marker to indicate which plants were male sterile. However, this approach has not been generally successful [1, 3, 4, 5]. We induced a new genic MS mutant, Hwacheong *ms-h*, by chemical mutagenesis on a Korean japonica cultivar, Hwacheong, using N-methyl-N-nitrosourea [6]. Here, we review the previous studies on the phenotypic characteristics of the mutant, isolation of the MS gene, and its feasibility in hybrid seed production system.

Phenotypic characterization and inheritance of the mutant

MS plants, Hwacheong *ms-h*, showed a shorter plant height, incomplete panicle exertion, and smaller panicle number compared to the parental plants as reported so far on the growth reduction in MS plants [6]. Meiosis was aborted in MS plants generating abnormal microspores. This implies that the MS gene affects whole stages of growth and development. MS phenotype was stable regardless of air temperature and day length. When the MS plants were pollinated with the parent, the F₂ seeds

were segregated into normally transparent and chalky grains, and the segregation ratio fit to 3:1. Interestingly, all of the chalky grains grew into MS plants while transparent grains grew into normally fertile plants (Fig. 1). After examination of cosegregation over generations, it was concluded that MS phenotype was controlled by a single recessive gene, which had a pleiotropic effect on chalky endosperm [7]. The gene was designated as *ms-h* and was mapped on chromosome 9.

Analysis of chemical composition of grains revealed that the MS grains, having homozygous-recessive MS genotype, showed lower amylose content in starch, higher lipid content, higher potassium content, and much lower gel consistency than corresponding normal grains (Table 1). Starch granules in endosperm of the MS grains were more roundish polyhedral and smaller than normal grains, and accordingly, some viscosity parameters also changed in the MS grains. Elution patterns on a Sephadex G-75 column of starch debranched by isoamylase revealed that the MS grains presented a higher Fr.III/Fr.II ratio and a shorter branching of amylopectin compared to the normal grains. This indicates that starch metabolic pathway in MS grains was modified by the MS gene [8].

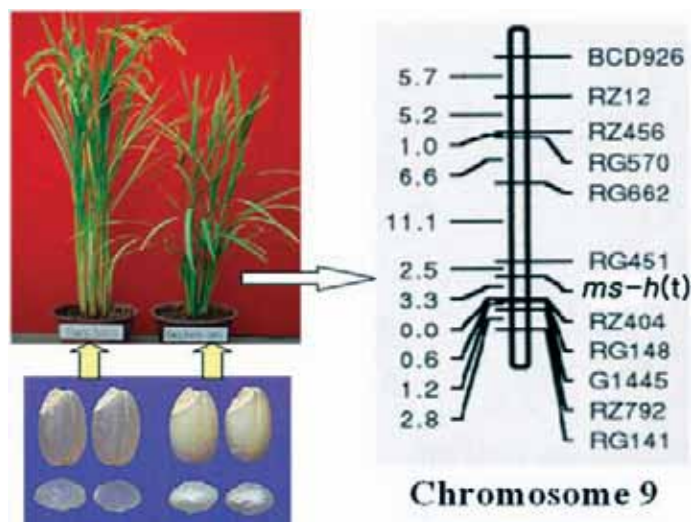

Figure 1 Appearance of plants and grains of Hwacheongbyeo (A) and MS mutant (B). The normally clear grains grow into normal-fertile plants and chalky grains into male-sterile plants as arrows indicate. The *ms-h(t)* gene was mapped on chromosome 9 (C).

Splicing error of *UGPase1* gene caused by single base substitution resulted in male sterility

Target locus of '*ms-h*' region was narrowed down through saturated mapping using STS and CAPS markers and finally was delimited to 60kb region containing 11 candidate genes [9]. After sequence comparison of the candidate genes between parent and the mutant, a single nucleotide substitution of Guanine to Adenine at the 3' splice junction of the

Dept of Plant Science, Seoul National University, Seoul 151-921, Korea

* Corresponding author. E-mail: heejkoh@snu.ac.kr

14th intron of the *UGPase1* gene was found to be critical (Fig. 2A/B). RT-PCR analysis using *UGPase1*-specific primers revealed that the mutant produced two types of transcripts which were 74-bp longer and 1-bp shorter compared to the wild type transcript (Fig. 2C). The deduced amino acid sequences of the mutant transcripts displaying two abnormal sizes suggests that both the 1-bp deletion and the 74-bp insertion cause frame shifts that generate two, independent stop codons in the process of translation, resulting in truncated 299-aa and 298-aa proteins instead of the 469-aa protein encoded by the wt *UGPase1* transcript. To confirm that the *UGPase1* gene is causally related to male fertility, we generated *UGPase1*-RNAi transgenic plants through transforming the parental plants with *UGPase1*-specific RNAi vector construct by *Agrobacterium*-mediated method. The RNAi transgenic plants were found to be male sterile. On the other hand, using the same transgenic technology, we complemented the MS phenotype by introducing an over-expression construct containing the wt *UGPase1* sequence into homozygous *ms-h* mutants. As expected, successfully transformed plants produced fertile panicles [9].

Table 1. Some physicochemical properties of chalky and normal grains

	1000 grs. Wt. at 10% MC (gr)	Absolute grain density (gr/cm ³)	Hardness at 10% MC (gr/grain)	Amylose content (%)	ADV at 1.2% KOH (1-7)	Protein content (%)	Gel consistency (mm)
Normal grains	18.9	1.486	6.27	20.3	5.5	9.80	100
Chalky grains	17.7	1.430	3.07	17.9	5.5	9.52	26
Difference	**	**	**	**	ns	ns	**

MC: moisture content

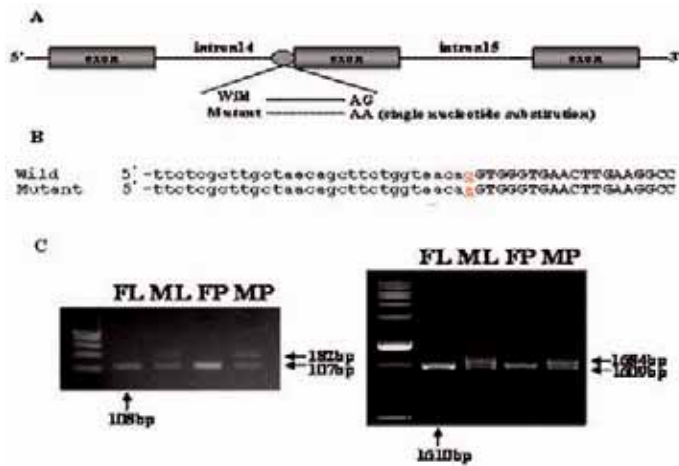

Figure 2 Schematic diagram of the *UGPase1* gene presenting single base substitution in the mutant (A, B) and unstable splicing in the mutant RNA(C). A. The mutation within the *UGPase1* gene in the *ms-h* mutant. B. Comparison of sequences between the wild type and the mutant indicating the one-base substitution at the 3-splice junction of the 14th intron. C. RT-PCR analysis with *UGPase1*-specific primers. As a result of each RT-PCR using the UGP1-PRT primer set (left) and the UGP1-FRT primer set (right), wt Hwacheong displayed only the expected size fragment in both reactions, while the *ms-h* mutant contained two fragments; one similar to wt and a second, longer fragment. The same banding pattern was observed in both leaf and panicle. The arrows pointing upward indicate the fragment size of the wt Hwacheong and the arrows pointing left represent the fragment size of the *ms-h* mutant. FL: fertile leaf, ML: ms leaf, FP: fertile panicle, MP: ms panicle.

To confirm that chalky endosperm results from a pleiotropic effect of the *ms-h* gene, we evaluated both male sterile and male fertile transgenic progeny to determine whether opaque seeds were always associated with

ms-h. In the case of *UGPase1*-RNAi transformants, male-sterile transgenic T₀ plants were crossed to wt Hwacheong as the male parent. Some of the F₁ progenies produced fertile panicles which segregated opaque F₂ seeds. The T₁ seeds harvested from 11 T₀ transgenic lines produced in complementation test were also examined for chalkiness after hulling. Chalky grains were segregated in two of the 11 plants. The opaque T₁ seeds harvested from c10 and c13 transformants were planted with other normal T₁ seeds to verify the pleiotropism with male-sterility. After maturing, we confirmed co-segregation of the *ms-h* gene and seed opaqueness based on phenotypic examination and molecular analysis of *UGPase1*-RNA expression patterns. These results clarify that the *ms-h* gene has a pleiotropic effect on chalky endosperm [9].

Feasibility of the mutant in producing hybrid seeds

Due to its pleiotropic effect on MS and chalky endosperm despite its nature of genic male sterility, the Hwacheong *ms-h* can be applicable to the hybrid seed production system. As seen in Table 1, since grain density of chalky grains which were MS grains was lower than normal grains, it might be possible to select MS grains by density gradient method. We tried to pick chalky grains out of seed mixture, in which normal and chalky grains are segregating, using NaCl solution. At the specific gravity level of 1.14~1.16 gr/ml, 85~90% of chalky seeds and 10~15% of normal seeds were floated [6]. If the MS seeds were chosen by this gravity method, 10~15% of normal seeds might be mixed in the seed bulk. However, the plant height of the seedlings of the mutant was significantly shorter, and was readily distinguishable in mixed seedling populations (Table 2). This may enable to rogue out most of the remnants of normal seedlings in seedling nursery that still remain after pre-screening by specific gravity method. Nevertheless, its feasibility for hybrid seed production still remains to be studied more in relation to the effectiveness and cost.

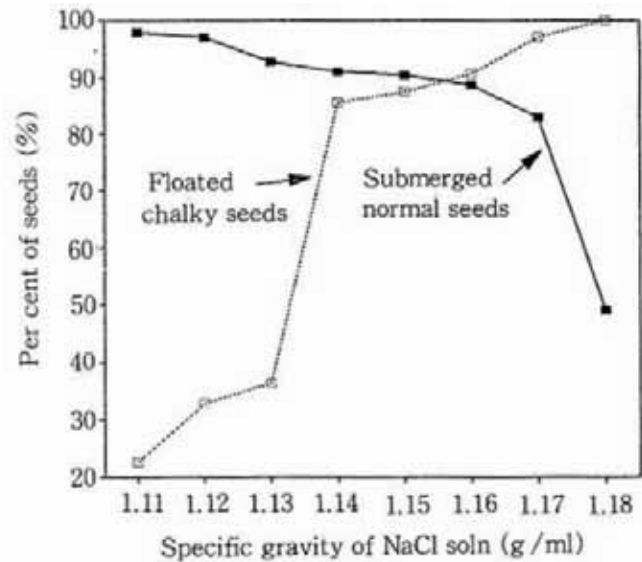

Figure 3 Percent of submerged and floated seeds in NaCl solution of different specific gravity.

Table 2. Plant height of the MS mutant line, Hwacheong *ms-h*.

	Days after seeding		Days after transplanting		
	15	30	15	30	45
Hwacheong	14.2±2.1	25.4±2.1	27.7±2.9	46.8±2.9	76.7±2.5
Hwacheong <i>ms-h</i>	9.2±1.9	18.9±2.7	22.6±2.8	37.5±3.2	64.0±3.5
Difference	**	**	**	**	**

ACKNOWLEDGEMENTS

This research was supported by a grant (code#CG3111) from the Crop Functional Genomics Center of the 21st Century Frontier Research Programme funded by the Ministry of Science and Technology, Republic of Korea. The corresponding author extends acknowledgements to IAEA/FAO for Fellowship support (IAEA/RCA, RAS/5/037) during the early phase of the gene isolation project at Cornell University in 2002.

BIBLIOGRAPHY

1. Kaul, M.L.H. Male sterility in higher plants, Vol. 10 1st edn. Berlin, Germany: Springer-Verlag, (1998).
2. Kurata, N., Miyoshi, K., Nonomura, K.I., Ymazaki, Y., Ito, Y. Rice mutants and genes related to organ development, morphogenesis and physiological traits. *Plant Cell Physiol.* **46**, 48-62 (2005).
3. Horner, H.T., Palmer, R.G. Mechanisms of genic male sterility. *Crop Sci* **35**, 1527-1535 (1995).
4. Galinat, W.C. Use of male sterile 1 gene to eliminate detasseling in production of hybrid seed of bicolor sweet corn. *J Hered* **66**, 387-388 (1975).
5. Suh, H.S., Kim, J.D., Heu, M.H., Chung, G.S. Linkage relationships between genetic male sterile and marker genes in rice. In: Rice Genetics II, p.121-125 (1991).
6. Koh, H.J., Heu, M.H. Agronomic characteristics of a mutant for genic male sterility-chalky endosperm and its utilization on F₁ hybrid breeding system in rice. *Korean J. Crop Sci.* **40**, 684-696 (1995).
7. Koh, H.J., Son, Y.H., Heu, M.H., Lee, H.S., McCouch, S.R. Molecular mapping of a new genic male-sterility gene causing chalky endosperm in rice (*Oryza sativa* L.). *Euphytica* **106**, 57-62 (1999).
8. Sohn, Y.H., Koh, H.J., Lee, H.S., Hen, M.H. Physicochemical characteristics of endosperm in a white-core mutant line "Hwacheong ms-h" causing male sterility in rice. *Korean J. Breed.* **29**, 424-430 (1997).
9. Woo, M.O., Ham, T.H., Ji, H.S., Choi, M.S., Jiang, W., Chu, S.H., Piao, R., Chin, J.H., Kim, J.A., Park, B.S., Seo, H.S., Jwa, N.S., McCouch, S., Koh, H.J. Inactivation of *UGPase1* Gene Causes Genic Male Sterility and Endosperm Chalkiness in Rice (*Oryza sativa* L.). *Plant J.* **54**, 190-204 (2008).

Barley (*Hordeum vulgare*) and Kiwicha (*Amaranthus caudatus*) Improvement by Mutation Induction in Peru

L Gómez-Pando*, A Eguiluz, J Jimenez, J Falconí, & E Heros Aguilar

Abstract

In order to increase food availability and household incomes of families in the Andean region of Peru, a mutation induction method was applied to improve barley (*Hordeum vulgare*) and kiwicha (*Amaranthus caudatus*) cultivars. Barley cultivar *Buenavista* was treated with 200 and 300Gy inducing different kinds of mutations. Twenty promising mutant lines were selected and have been evaluated at the national trials. From them Mbv-Earlier, from 300Gy dose was selected and released in 2006 as a new cultivar denominated *Centenario*. This cultivar has a high yield potential (5,552 kg/ha), resistance to stripe rust (*P. striiformis f.sp hordei*) and better food quality than the parental cultivar. Kiwicha traditional cultivar *Seleccion Ancash* treated with 400Gy, identified a higher yield mutant denominated *Centenario* Cultivar. At farmer location in the coast the yield has a variation of 3,500 to 5,500 kg/ha and in the highland from 2,500 to 3,700 kg/ha. The better yield potential, tolerance to *Sclerotinia sp*, color and size of its grains have contributed in the preference of *Centenario* over other commercial cultivars.

Introduction

In Peru it is very important to produce more food, especially in the rural areas, where the population lives in extreme poverty. The increase of food must be made in amount and quality using improved cultivars, among other factors. Due to bad weather and soil, there are few crops that are able to grow in these marginal conditions and among them are the cereals and native grains. There is evidence that cereal and native grains in a mixture can produce food of a high nutritive value because of the amino acids and the other nutrients that are complementary. The improved cultivars should have the capability to overcome most of the limiting factors of the marginal conditions of the highlands of Peru, such as shallow and low fertility soils, drought, and frost and hail storms. The crop technology used in the cereal and native grains production are very low. The mutation induction methodology can be applied to improve many plant species. Two thousand, five hundred and forty three mutant cultivars of 175 plant species have been developed through induction mutation; some of them are grown at large scales [3, 7]. Valuable progress has been reported on the improvement of several characters of plants by mutation induction such as yield, life cycle, disease resistance, quality characters, grain quality, abiotic stress resistance, improved plant type and others [5; 6, 8, 12, 13, 14, 15,16, 18].

Barley

In Peru, barley is the fourth most important food crop in terms of area of land dedicated to its production. Barley is one of the few crops suitable for the extensive and marginal highlands where frost and drought are very frequent.

Materials and Methods

The dried seed of barley cultivar *Buenavista* was treated with Gamma-rays at 200 and 300Gy doses. The treated seeds along with the control were sown to rise the M_1 generation. Spikes were harvested individually and raised as M_2 progeny in spike/row. In the M_2 generation, chlorophyll mutants were scored and classified following the classification presented in reference [9, 10]. Individual spikes were selected in normal plants within all the rows showing mutations of any kind in the M_2 and M_3 generations to handle initial germplasm. This approach was made looking for micro mutants-forms without clear difference from the parental cultivar. The promising mutant lines and their progeny have been tested in different locations and years following the conventional breeding procedures in the generations M_4 to M_7 .

Results and Discussion

On the basis of M_2 seedlings, the number of plants with chlorophyll mutations and the spectrum observed are presented in **Table 1**. The frequency of chlorophyll mutation varied from 0.05 to 0.91 percent for 200Gy and from 0.05 to 0.72 per cent for 300Gy. The frequency values followed an irregular trend. This result it was a preliminary index of effectiveness of mutability of the cultivar *Buenavista*, similar observation was reported [4, 11, 17]. The following different kinds of chlorophyll mutations were found: albino, xantha, xantha-alba, viridis- albino, albo-viridis, virescens, chlorina, lutescens, albescence, tigrina, striate and maculate. Among the 12 chlorophyll mutants, albino was found to be the maximum followed by virescens in the two doses.

Table 1. Frequency and spectrum of chlorophyll mutants in M_2 generations of *Buenavista* cultivar irradiated with Gamma-rays.

Chlorophyll mutations	Gamma-rays (Grays)	
	200	300
Albino	0,91	0,72
Xantha	0,05	-
Xantha- alba	0.06	0,08
Viridis-albino	0.08	0,05
Albo-viridis	0.02	0,03
Virescens	0.69	0,57
Chlorina	0,35	0,44
Lutescens	0.07	0,20
Albescens	0,09	0,21
Tigrina	0,20	0,05
Striata	0,05	0,15
Maculata	0,30	0,23

In the M_2 population, 16 types of different mutations have been observed such as life cycle, plant height, habit of growth, shape of leaves, waxy foliage, row of spike, spike density, number of flowers, waxy spike,

Cereal Research Programme, Universidad Nacional Agraria de La Molina, Lima, Peru

* Corresponding author. E-mail: luzgomez@lamolina.edu.pe

awnless spike and naked grains. **Table 2** shows the different frequencies and types of mutations. There were more kinds of mutations and higher frequencies with the higher doses. The interesting aspects of these results were the significant genetic variability created in different plant characters. This is an indication of the possibility for improvement of many characters through induced mutations [5, 18]. Rice research work, in Peru, using induction mutation reported changes in characters as heading date, maturity date and plant height [8, 16].

Table 2. Frequency of different kinds of mutations in Buenavista Cultivar irradiated with Gamma-rays

Mutations	Gamma-rays (Grays)	
	200	300
Heading date (Very late-super early)	0,02	0,13
Maturity date (Very late-super early)	0,01	0,04
Height reduction	0,01	-
Height increment	0,05	0,08
Prostrate habit of growth	0,006	0,09
Narrower leaves	-	0,014
Waxy foliage	-	0,014
Six rows	0,034	0,044
Irregular spike	0,095	0,106
Raquis internodes reduction	0,017	-
Raquis internodes increment	-	0,014
Increment of number of flowers	-	0,014
Awnless spike	-	0,014
Waxy spike	0,022	-
Naked grain	0,091	0,071

Table 3 presents some agronomic characteristics and the response to yellow rust (*Puccinia striiformis* f *sp hordei*) of the mutant line Centenario (Mbv-earlier), Buenavista (parent line) and modern and traditional commercial cultivars. Centenario had a significant higher yield than the parental line and the traditional cultivars and slightly lower yield than the modern cultivars; however this difference was not significantly high. The yield of Centenario improved by 37% over the parent cultivar. For the duration of the life cycle (heading and maturity data), Centenario mutant was the earliest cultivar, 18 days earlier than the parental cultivar. The plant height of Centenario was similar to that of the parent and shorter than the other commercial cultivars. All genotypes including Centenario were resistant to yellow rust with the exception of Yanamucllo and Zapata. In reference [13] it is reported that the significant increase in cotton yield achieved with the mutant NIAB 78 in Czechoslovakia and mutant barley Diamant exceeded 12% return on the original variety. Reference [18] reports that mutation in productivity, grain size, protein content, and duration of vegetation period in barley. Reference [15] reports mutations in precocity in rice.

Among the characteristics related to barley quality presented in **Table 4**, the greatest statistically significant difference between parental cultivar Buenavista and Centenario mutant cultivar was in protein content (%) and test weight (kg/HI). Centenario Mutant had better values of protein content, thousand-kernel weight and test weight than the traditional and modern cultivars. Reference [1] reported valuable progress on the improvement of nutritional quality of cowpea “IT84S 2246 D” mutants.

Centenario mutant cultivar shows four principal differences with the parental cultivar Buenavista, better yield, earlier life cycle date, better protein content and better test weight. The combination of these characters with a good plant weight and resistance to yellow rust made the cultivar Centenario very valuable for the highland farmers.

Centenario is replacing the traditional and modern cultivar at the central highlands of Peru. The replacement means self-sufficiency and improvement of household income through the sale of surplus (**Table 5**). Improvement of the quality implies an improvement of the nutritional value and increased price of the product. Current prices of traditional and modern cultivars per ton varies from 185 to 296 US dollars, and those obtained with Centenario can reach 488 to 533 US dollars, because of higher grain quality (**Table 6**).

Table 3. Mean yield, heading date, maturity date, plant height and response to yellow rust of Centenario mutant cultivar compared with the parent cultivar Buenavista and commercial barley cultivars

Genotypes	Yield (kg/ha)	Heating date (days)	Maturity date (days)	Plant height (cm)	Yellow rust
UNALM 96	5812.7a	73.7cd	160.0b	108.3bc	0
UNALM 94	5697.7a	81.3a	172.0a	112.3b	0
Centenario (Mutant Cultivar)	5552.3a	64.7e	141.0d	106.3c	0
UNALM 95	5114.7b	68.0de	143.67d	109.3bc	0
Buenavista (Parent cultivar)	4041.7c	72.7cd	159.7b	107.0c	0
Yanamucllo (Traditional Cultivar)	3281.0d	78.0ab	149.0c	112.0b	80s
Zapata (Traditional Cultivar)	3198.0d	78.7a	169.7a	119.3a	30s

Table 4. Mean protein content, thousand-kernel weight and test weight of Centenario mutant cultivar compared with the parent cultivar Buenavista and commercial barley cultivars

Genotypes	Protein content (%)	Thousand-kernel weight (g)	Test weight Kg/HI
UNALM 96	9.12c	41.41b	67.1c
UNALM 94	9.49b	39.62b	59.1d
Centenario (Mbv-Earlier)	10.26a	51.72a	77.2a
UNALM 95	9.54b	51.42a	77.3a
Buenavista (Parent cultivar)	9.33bc	50.44a	71.4b
Yanamucllo (Traditional Cultivar)	8.10d	40.89b	68.4c
Zapata (Traditional Cultivar)	7.71e	37.62c	58.4

Table 5. Mean yield (kg/ha) of Barley Mutant Cultivars compared with old cultivars in farmer field at the highland of Peru

Location	Old Cultivars (Kg/ha)	Mutant Cultivars (Kg/ha)	Increase %
Junín	1600	2400	50
Huancavelica	1200	2640	105
Huanuco	1000	2200	120

Table 6. Commercial value of barley mutant cultivars production per hectare compared with the old cultivars at farmer location

Location	Old Cultivars US \$	Mutant Cultivar US \$	Increase %
Junín	296	533	80
Huancavelica	200	586	193
Huanuco	185	488	163

Kiwicha

Kiwicha (*Amaranthus caudate*) is a native and ancient crop of the Andean region. It has been rediscovered as a promising source of high quality protein food and as a drought-tolerant crop. It has the potential to broaden the diversity of commercially grown crops and make an important contribution to food supplies in the near future with the world's growing water shortage. The aim of this research work was to improve the traditional cultivar Ancash of *Amaranthus caudatus* using Gamma-rays. A mutation induction method is used to improve well-adapted cultivars, through 2].

Materials and Methods

Dried seeds of the traditional cultivar "Selection Ancash," previously purified in isolated conditions, were treated with Gamma-rays at doses of 100, 200, 300, 400, 600, 800 and 1,000Gy. A wide range of doses with Gamma-rays was selected because there were no reports of similar work in *Amaranthus caudatus*. The management of generation M₁ to M₇ was similar to that used in barley and described above.

Results and Discussion

In generation M₂, two types of mutations were identified in the treatment with 400Gy (Table 7). The other lower doses did not show any kind of mutation and the higher doses at M₁ generation killed the major part of plants. The frequency chlorophyll and plant color mutations are showed in Table 8.

Table 7. Frequency of different kinds of mutations in selection Ancash cultivar irradiated with Gamma-rays

Gamma-rays	No. Plants	No. of mutants	Mutation frequency	Type of mutation
400	186 915	3	0.00161	Chlorophyll (Xhanta)
		36	0.0193	Plant and grain colour

In generation M₃ and M₄ mutants with different yield potential were selected among the 36 mutant lines. In Table 8, five mutants had more yield than the parental cultivar. From these lines Centenario cultivar was selected and liberated in March 2006 with similar quality, better yield and different plant color than the parental material from the treatment of 400Gy of Gamma-rays. At farmer location in the coast the yield has a variation of 3,500 to 5,500 kg/ha and in the highland from 2,500 to 3,700 kg/ha. Some mutant varieties of rice had considerable economic impact, such as the mutant Yuanfengzao developed through irradiation with Gamma-rays. This variety matures about 45 days earlier than the parent material IR8, and still has high yield potential close to 10t/ha. During 1975-1983 the cultivation acreage reached six million hectares [13].

Table 8. Mean yield of Kiwicha mutant lines compared with the parental line "Selection Ancash" in experimental plot in La Molina

Genotypes	Yield (Kg/Ha)	Duncan Test (5%)
Centenario (MSA 011)	5,541	A
MSA 017	5,337	A
MSA 014	4,898	A
MSA 012	4,834	A
MSA 010	4,804	A
MSA 018	4,354	A B
MSA 013	4,331	A B
MSA 015	4,156	A B
MSA 016	4,147	A B
Selección Ancash (P)	2,764	B

The experiments conducted in different locations of the coasts and the highlands of Peru have permitted us to learn about the wide adaptation, and the tolerance to salinity and to *Sclerotinia sclerotiorum*, as well as the fact that it is earlier than the Oscar Blanco commercial cultivar. The better yield, color and size of its grains have contributed to the preference of Centenario over the other commercial cultivars. The area seeded with Centenario is nearly 40% of the total of Peruvian land dedicated to kiwicha crop.

Conclusions

1. Significant genetic variability was identified, especially in barley, with respect to chlorophyll mutations, morphological and physiological characters after treatment with Gamma-rays.
2. The mutant cultivars Centenario barley and Centenario Amaranthus- Kiwicha have a superior or similar behavior in important agronomic and quality characters compared to parent material and traditional and modern commercial cultivars.
3. In farmer fields the mutant cultivars are widely accepted, improving the amount and quality of the food. Household incomes are improving due to the higher prices reached in the commercialization of the mutants.

ACKNOWLEDGEMENTS

Thanks to the International Atomic Energy Agency, Backus Foundation, NGO Caritas Peru, NGO ADRA Peru, Farmer Associations of Acostambo and Nahuinpuquio-Huancavelica and Farmer Associations in Vicso and Sincos.

BIBLIOGRAPHY

1. Ahloowalia, B., Maluszynski, M., Nichterlein, K. Global Impact of mutation-derived varieties. *Euphytica* 135(2), 187-204, (2004).
2. FAO/IAEA, <http://www-infocris.iaea.org/MVD/default.htm>
3. Chopra, V. L. Mutagenesis: Investigating the process and processing the outcome for crop improvement. *Current Science*, 89(2), 353- 359 (2005).
4. Castillo, A.M., Cistue L., Valles, M.P., Sanz, J.M., Romagosa I., Molina-Cano, J.L. Efficient production of androgenic doubled-haploid mutants in barley by the application sodium azide to anther and microspore cultures. *Plant Cell Reports* 20, (2001) 105-111.
5. GONZÁLEZ H. Caracterización de líneas mutantes de la variedad de arroz Amazonas obtenidas mediante aplicación de rayos gamma. Agronomist Thesis, Universidad Nacional Agraria La Molina, (2004).
6. Maluszynski, M., Ahloowalia, B., Sigurbjornsson, B. Application of *in vivo* and *in vitro* mutation techniques for crop improvement. *Euphytica* 85, 303-315 (1995).
7. Maluszynski, M., Ahloowalia, B., Ashiri, A., Nichterlein, K., L. Van Zaten. Induced Mutations in rice breeding and germplasm enhancement. Plant Breeding and Genetic Section, Joint FAO/IAEA Division of Nuclear Techniques in Food and Agriculture, Vienna, Austria, (1999).
8. Maluszynski, M., Nichterlein, K., Van Zanten, L., Ahloowalia, B. S. Oficially released mutant varieties FAO/IAEA database, *Mutation Breeding Review* 12, 1-84 (2000).
9. Poehlman, J.M., Sleper D.A. Mejoramiento genético de las cosechas. Editorial Limusa, S.A. de C.V. grupo Noriega Editores, México, 122-128 (2003).
10. Sanjinez F. Mejoramiento Genético del Cultivo de Arroz, (*Oryza sativa* L.) mediante Mutaciones Inducidas. Mg. Sc. Thesis. Universidad Nacional Agraria, La Molina. Lima, Perú, (2001).
11. Shevtsov, V.M. Barley Improvement with the Use of Induced Mutations. In Proceedings of the 8th International Barley genetics Symposium. Volume III, 170- 172 (2000).
12. INTERNATIONAL ATOMIC ENERGY AGENCY. Manual on mutation breeding, 2nd edition, Technical Report Series, No. 19, Vienna, Austria, 1-285 (1977).
13. Gustafsson, A. Mutation in agricultural plants. *Hereditas*, 33, 1-40 (1947).
14. Akbar, A.C., Babar, M.A. Radiosensitivity studies in basmati rice. Nuclear Institute for Agriculture and Biology, *NIAB. Pak. J. Bot.* 35(2), 197-207 (2003).
15. Maluszynska, J., Maluszynski, M. MNUA and MH mutagenesis effect after double treatment of barley seeds in different germination periods. *Acta Biologica* 11, 238-248 (1983).
16. Sheeba, A., Ibrahim, S.M., Yogameenakshi, P., Babu, S. Studies on induced chlorophyll mutation in sesame, (*Sesamum indicum* L.). *Madras Agric. J.* 91(1-3), 75-78 (2004).
17. Adekola, O.F., Oluleye, F. Influence of mutation induction on the chemical composition of cowpea *Vigna unguiculata* L. Walp. *African Journal of Biotechnology* 6(18), 2143-2146 (2007).
18. Ahloowalia, B. Radiation techniques in crop and plant breeding: Multiplying the benefits. IAEA Bulletin, 40/3, 37-39 (1988).

Understanding the Molecular Mechanisms of Disease Resistance Using Rice Mutants

Y Jia

Abstract

The *Pi-ta* gene in rice has been used to prevent the rice blast disease worldwide for several decades. In the US, *Pi-ta* was introgressed from a landrace indica variety, Tetep, into several tropical japonica cultivars including Katy. *Pi-ta* is predicted to encode a cytoplasmic receptor that directly binds to the elicitor produced by the pathogen avirulence gene *AVR-Pita* for initiating resistance. Katy, expressing resistance conditioned by *Pi-ta*, *Pi-ta*², and *Pi-k*^s to the races of *M. oryzae*, IB1, IB45, IB49, IB54, IC17, IH1, IE1, and IG1, was treated with mutagens, fast neutrons and ethyl methyl sulfate (EMS). Six mutants with enhanced resistance or susceptibility were identified by screening M₂ seedlings derived from 15,000 M₁ plants. Among them, M562, induced by EMS, is a lesion mimic mutant (named as LMM1) that produces spontaneous hypersensitive cell death. This rapid cell death was quickly induced using detached leaves at and near the site of inoculation by the virulent race IE1k and more slowly induced when inoculated with the avirulent isolate IB49. Similar hypersensitive cell death was observed after detached leaves were inoculated with the fungus *Rhizoctonia solani*, the causal agent of rice sheath blight disease. Hypersensitive cell death is known to be a form of the defense response. Thus, we suggest that LMM1 has enhanced resistance to both rice blast and sheath blight pathogens. Although the *Pi-ta* gene in rice provides resistance to the races, IB1, IB45, IB49, IC17, IH1, IE1, IB54, and IG1, the mutant M2354 was observed to be susceptible to all races except IB54 although there was no change in the *Pi-ta* DNA sequence. Expression of *Pi-ta* in M2354 was also similar to that of the parent examined by qRT-PCR. Thus, mutations in M2354 likely occurred at a new locus named as *Ptr(t)*. Another four lines were determined to be near isogenic lines at a 9 megabase genomic region spanning the *Pi-ta* locus of Katy. Progress on characterizing these six genetic stocks is presented.

Introduction

In contrast to humans and animals, plants are not able to physically move to escape from pathogens. Over time plants have evolved multifaceted sophisticated mechanisms to cope with the pathogens. Knowledge of mechanisms of interactions between both plant and pathogen genes is important for crop protection. Rice -*Magnaporthe oryzae* is a model system for studying mechanism of host-pathogen interaction. Available resources for this system include the map based genome sequences of rice, draft sequence of a strain of the fungal pathogen, high density integrated physical and genetic maps of rice, and the ability to perform genetic analysis of both rice and the pathogen. To date, over forty race specific blast resistance (*R*) genes have been identified, seven of which have been molecularly characterized. Most cloned blast *R* genes are highly similar to other plant *R* genes that encode putative receptor pro-

teins with nucleotide binding sites and leucine rich repeats. Among 7 blast *R* genes, a single amino acid in three *R* genes was known to determine the pathogen recognition specificity.

We are investigating the genetic mechanism of the host-pathogen interaction using the blast *R* gene *Pi-ta* and the corresponding avirulence gene *AVR-Pita*. *Pi-ta* is a putative cytoplasmic receptor with nucleotide binding sites and leucine rich domain, whereas *AVR-Pita* is a metalloprotease whose product is predicted to bind to leucine rich domain of the *Pi-ta* protein [1,2]. Limited surveys of rice germplasm and isolates of the pathogen revealed that both *Pi-ta* and *AVR-Pita* may have coevolved. Continued characterization of more *R* genes and other plant factors that are involved in pathogen recognition and transduction pathways should clarify how plant *R* genes have evolved to activate innate immunity to the pathogen. Here we report six new genetic stocks identified after seeds of a *Pi-ta*-containing cultivar were treated with Ethyl Methyl Sulfate (EMS) and fast neutrons.

Materials and Methods

Plant materials, mutagen treatment and M₁ growth-A tropical japonica rice cultivar Katy resistant to the 10 common races of *Magnaporthe oryzae* in the US, was used for this study [8]. Three different concentrations 0.4%, 0.8% and 1.2% of EMS were used to treat Katy following a protocol of Hu and Rutger [6]. Fast neutrons at 7.7, 26.3, 49.9 Gy were used to treat rice seeds at Oakridge Laboratory, TN, USA. Treated M₀ seeds were grown in fields in Stuttgart in 2001 and 2004 respectively. A panicle from each M₁ plant was harvested and was subsequently amplified in a greenhouse.

The fungal isolates and mutant screening-A virulent isolate TM2 of race, IE1k, was used to screen for enhanced resistance and an avirulent isolate ZN57 of race IC17 was used to screen for susceptibility. Seventeen M₁ seeds from each M₁ panicle were grown in a pot, and M₂ rice seedlings at three to four leaf stage were spray-inoculated with spores of *M. oryzae* at 5 X 10⁵ spores/mL. Inoculated seedlings were incubated in a dew chamber overnight, and were moved to a greenhouse for an additional six days to allow phenotype development. Rice seedlings with disease or hypersensitive cell death were transplanted into new pots and grown to maturity.

Simple sequence repeat (SSR) marker analysis, PCR amplification, cloning, sequence analysis and controlled inoculations-SSR analysis, PCR amplification, cloning and sequence analysis were performed using procedures described in Jia and Martin [3]. Controlled inoculations with *M. oryzae* followed a procedure by Jia, *et al* [5] and with *R. solani* followed a procedure described by Venu, *et al* [9].

Results

A total of 142 rice seedlings with altered blast disease reactions were transplanted to produce seeds in a greenhouse. Eight SSR markers were used to determine the origin of the putative mutants. Twenty mutants were confirmed to be derived from Katy, and six of these were further characterized in the present study (**Table 1**).

USDA-ARS Dale Bumpers National Rice Research Center, Stuttgart, Arkansas, United States of America

E-mail: yulin.jia@ars.usda.gov

Table 1. SSR genotyping and disease reactions to rice blast and sheath blight pathogens

The parent and mutant line	SSR marker								Disease reaction	
	RM149	RM190	RM22	RM225	RM481	RM484	RM303	RM489	M. oryzae ^c	R. solani ^d
Katy	241	113	192	143	217	293	144	270	R	MR
2354 ^a	241	113	192	143	217	293	144	270	S	MR
2494 ^a	241	113	192	143	217	293	144	270	S	MR
4935 ^a	241	113	192	143	217	293	144	270	S	MR
2500 ^a	241	113	192	143	217	293	144	270	S	MR
5415 ^a	241	113	192	143	217	293	144	270	S	MR
562 ^b	241	113	192	143	217	293	144	270	R	R

^a The mutant was derived from a M₀ seed treated with fast neutrons.

^b The mutant exhibits lesion mimic symptoms derived from a M₀ seed treated with 0.8% ethyl methyl sulfate.

^c The races, IB1, IB45, IB49, IC17, IH1, IE1, and IG1 of *M. oryzae* were used for inoculation. Disease reaction was scored as a scale 0 to 5, 0-2 is resistant and 3-5 is susceptible. The parent and all mutant lines were resistant to IB54.

^d Three isolates of *R. solani* were used, and disease lesions were compared with Katy. MR indicates moderate resistance and R indicates enhanced resistance.

Mutant 2354- M2354 has identical alleles for 8 SSR markers and morphological traits (data not shown) to the parent Katy but is susceptible to nine races of rice blast in the US except race IB-54 (Table 1, Fig. 1). Fig. 1A shows typical symptoms of the susceptibility of rice blast fungus.

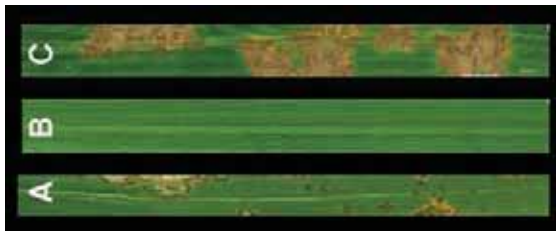

Figure 1 Symptoms of lesion mimic and blast disease. Typical symptoms of rice blast disease observed in mutants 2354, 2500, 2912, 4935 and 5415 (A), healthy non inoculated rice leaf (B) and phenotypes of lesion mimic mutant 1 (mutant 562) (C).

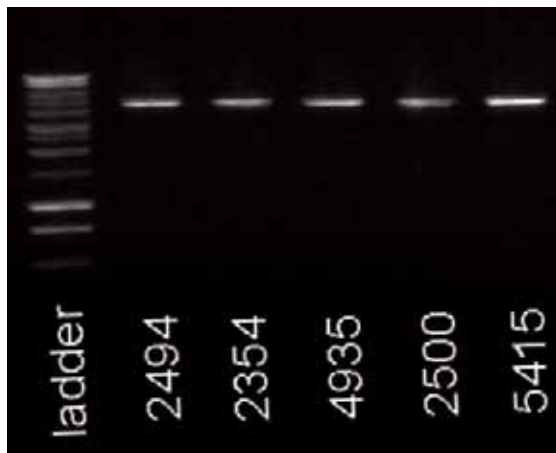

Figure 2 PCR amplification of the *Pi-ta* alleles from 5 susceptible lines. The same size of the *Pi-ta* allele was amplified using the *Pi-ta* gene specific primers.

The *Pi-ta* gene in Katy confers resistance to the races IB1, IB45, IB49, IC17, IH1, IE1, IG1 and IB54 and *Pi-k^s* confers resistance to IB54. These results suggest that either *Pi-ta* or a genetic factor required for *Pi-ta* is defective in M2354, and this defect is likely specific to the *Pi-ta*-mediated defense response. The genomic region including 863 bp of 5' untranslated region, open reading frame, intron, and 500 bp of 3' untranslated region

of the *Pi-ta* allele in M2354 was amplified (Fig. 2) and amplified products were determined to be identical to that of Katy. However, genomic sequences of the *pi-ta* alleles in M2494, M4935, M2500 and M5415 were identical to that of the *pi-ta* allele in one of susceptible parents in Katy's background (data not shown). Further genotyping using 50 SSR markers revealed that these lines were near isogenic lines from the parent Katy but had a 9 megabase region on chromosome 12 comparable to that of susceptible parent (data not shown).

Expression of the *Pi-ta* allele in Katy was identical to that in M2354 as examined by RT-PCR and real time RT-PCR [3]. Taken together, these data suggest that the *Pi-ta* allele was not altered, and hence we predict that an additional component in M2354 was defective rendering disease susceptibility. Further segregation analysis of the progeny of the cross of Katy with M2354 revealed that a nuclear gene had been altered. This gene was designated as *Pi-ta* required (*R*) gene temporary [*Ptr(t)*]. *Ptr(t)* was tentatively mapped at the *Pi-ta* locus, and is being identified using a map based cloning strategy.

Mutant 562- M562 was named as lesion mimic mutant 1 (LMM1) [2]. Lesion mimic plants are plants that produce spontaneous disease lesions similar to hypersensitive cell death in the absence of the pathogen attack (Fig. 1). Lesion mimic phenotypes of LMM1 were found to be rapidly induced three days after inoculation with a virulent isolate TM2 of *M. oryzae*, and the same phenotype was found to be induced by an avirulent isolate ZN60 of *M. oryzae* 6 days after inoculation (Fig. 3). Rapid occurrence of the cell death was hence predicted to be one plausible mechanism to prevent the invasive growth of the fungal pathogen [11].

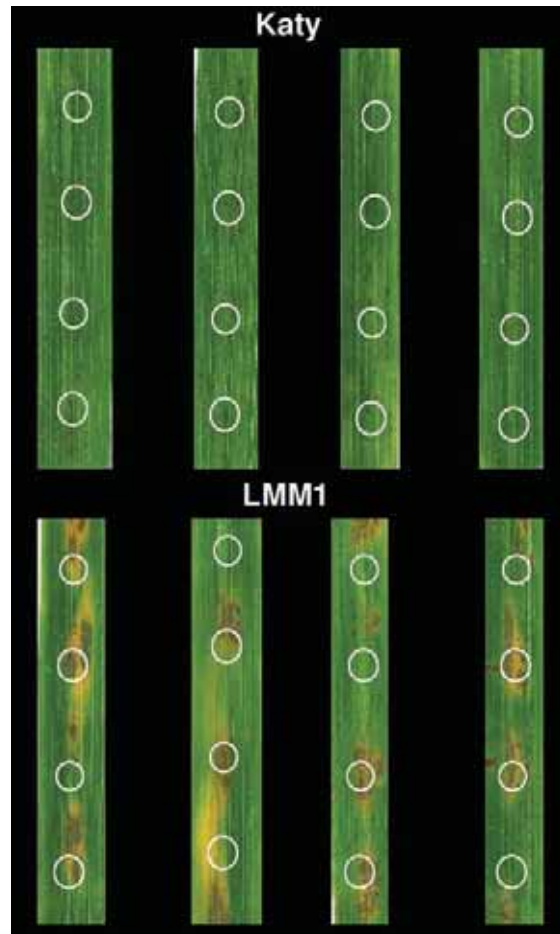

Figure 3 Induction of lesion mimic phenotypes on detached rice leaves. No visible lesions could be seen four days after detached leaves of the parent Katy were inoculated with isolate ZN57 (IC-17) of *M. oryzae* (upper panel); however, lesions were induced on the detached leaves of LMM1 at and near the sites of inoculation (lower panel). Five uL of spores at 4.16 X 10⁵ spore/mL were inoculated onto indicated positions on detached leaves.

To determine if enhanced resistance was specific to rice blast pathogen, disease reactions of LMM1 to *R. solani*, the causal agent of rice sheath blight disease, were also determined. As shown in Fig. 4, smaller disease lesions were observed four days after inoculation with three field isolates of *R. solani*. This result suggests that LMM1 also has enhanced resistance to *R. solani*.

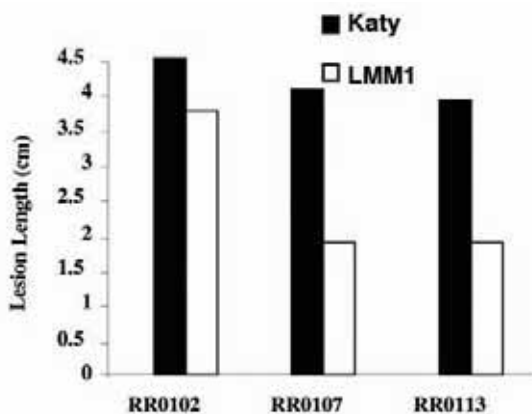

Figure 4 Smaller lesions were observed after detached leaves of LMM1 was inoculated with three field isolates of *R. solani*. Detached leaves of Katy and LMM1 were inoculated with three isolates RR0102, RR0107 and RR0113 of *R. solani*. Lesion length was measured from the center of the inoculation four days after inoculation.

Discussion

In this study, six genetic stocks for studying the molecular mechanisms of host-pathogen interaction were developed by fast neutrons and EMS. Two mutants were identified with alteration in different genetic components of resistance.

LMM1 is a lesion mimic mutant similar to Sekiguchi sasahi (*sl*) [7]. Both mutants produce spontaneous cell death and are conditioned by single recessive genes [2,7]. Allelism test suggests that LMM1 is not allelic to *sl* (Jia, unpublished data). We observed that LMM1 had enhanced resistance to both rice blast and sheath blight pathogens. Similarly, Yin, *et al* [10] reported that a lesion mimic mutant exhibiting small brown spots had broad resistance to both rice blast and sheath blight diseases. LMM1 identified in this study is another genetic resource that can be used to dissect the components in host-pathogen interactions.

M2354 has a defect at the *ptr(t)* locus resulting in susceptibility to blast. Pathogenicity assays using *M. oryzae* isolates recognizing *Pi-ta* and *Pi-ta²* revealed that M2354 lost resistance mediated by *Pi-ta* and *Pi-ta²* (B. Valent, unpublished data). The *Ptr(t)* gene was recently fine mapped and the candidate genes are being sequenced for confirmation.

M2494, M4925, M2500 and M5415 are near isogenic lines possessing a 9 megabase region from a susceptible parent of Katy. It is believed that

these are a result of a heterogeneous seed source of Katy being mutagenized at the onset of this project. Nevertheless, these lines are useful to study biological functions of genes within this region.

To summarize, we have identified six genetic stocks of *Pi-taptr(t)*, *pi-taptr(t)*, and *Pi-taPtr(t)* homozygotes with and without lesion mimic phenotypes. These genetic stocks are important materials to study the functions of important plant genes, some of which are involved in *Pi-ta*-mediated signaling recognition and transduction pathways [1,4]. Further manipulation of genetic interactions of these genes should facilitate the development of more effective strategies to control plant diseases.

ACKNOWLEDGEMENTS

The author thanks Michael Lin, Konstantin Gubrij, and Hui Lin and past and present lab members of the Molecular Plant Pathology programme of USDA-ARS Dale Bumpers National Rice Research Center for excellent technical support. For the review, the author thanks Melissa H. Jia, Drs. Anna. McClung, J. Neil Rutger, YonBao Pan.

BIBLIOGRAPHY

- Bryan, G.T., Wu, K.S., Farrall, L., Jia, Y., Hershey, H., Mcadams, S., Tarchini, R., Donaldson, G., Faulk, K., Valent, B. A single amino acid difference distinguishes resistant and susceptible allele of the rice blast resistance gene *Pi-ta*. *Plant Cell* **12**, 2033-2045 (2000).
- Jia, Y. Registration of lesion mimic mutant of Katy rice. *Crop Sci.* **45**, 1675 (2005).
- Jia, Y. Martin, R. Identification of a new locus, *Ptr(t)*, required for rice blast resistance gene *Pi-ta*-mediated resistance. *Molecular Plant-Microbe Interactions* **21**, 396-403 (2008).
- Jia, Y., Mcadams, S.A., Bryan, G.T., Hershey, H., Valent, B. Direct interaction of resistance gene and avirulence gene products confers rice blast resistance. *EMBO J.* **19**, 4004-4014 (2000).
- Jia, Y., Valent, B., Lee, F.N. Determination of host responses to *Magnaporthe grisea* on detached rice leaves using a spot inoculation method. *Plant Dis.* **87**, 129-133 (2003).
- Hu, J., Rutger, J.N. Pollen characteristics and genetics of induced and spontaneous genetic male-sterile mutants in rice. *Plant Breed.* **109**, 97-107 (1992).
- Marchetti, M.A., Bollich, C.N., Uecker, F.A. Spontaneous occurrence of the Sekiguchi lesion in two American rice lines: Its induction, inheritance, and utilization. *Phytopathology* **73**, 603-606 (1983).
- Moldenhauer, K.A.K., Lee, F.N., Norman, R.J., Helms, R.S., Well, R.H., Dilday, R.H., Rohman, P.C., Marchetti, M.A. Registration of 'Katy' rice. *Crop Sci* **30**, 747-748 (1990).
- Venu, R.C., Jia, Y., Gowda, M., Jia, M.H., Jantasuriyarat, C., Stahlberg, E., Li, H., Rhineheart, A., Boddhireddy, P., Singh, P., Rutger, J.N., Kudrna, D., Wing, R., Nelson, J.C., Wang, G. RL-SAGE and microarray analysis of the rice transcriptome after *Rhizoctonia solani* infection. *Mol. Genet. and Genomics* **278**, 421-431 (2007).
- Yin, Z., Chen, J. Zeng, L. Goh, M. Leung, H., Khush, G.S., Wang, G.L. Characterizing rice lesion mimic mutants and identifying a mutant with broad-spectrum resistance to rice blast and bacterial blight. *Mol. Plant Microb. Interact* **13**, 277-286 (2000).
- Wang, Z., Lin, H., Valent, B., Rutger, J.N., Jia, Y. Cytological and molecular analyses of disease resistance to the rice blast fungus. *Chinese J. of Rice Sci* **21**, 335-340 (2007).

An Innovative Way of Developing an Improved Variety Utilizing Both Gamma-ray-induced and Recombinational Variability in Blackgram (*Vigna mungo* L.(Hepper))

S T Kajjidoni*, K Roopalaksmi, S Revanappa & I NagaraI

Abstract

An attempt was made to compare variability generated through different mating schemes and combination of mating and irradiation in *Vigna mungo* L. (Hepper) to improve productivity of recommended varieties. Two locally adapted varieties and two selected complimentary donor lines for high pod number and for seed mass were crossed to generate four single crosses, two three way and one double crosses. Four single crosses were further irradiated with 20 Kr Gamma-rays and advanced to F_2M_2 and F_2 generations for evaluation based on seven agronomic traits. Variability generated by irradiation was more compared to recombination variability for clusters per plant and pod length traits. Irradiated single cross (F_2M_2) progenies produced higher frequency of superior progenies compared to other hybridized progenies involving two or more than two parents. The nature of association between pod length and number of pods per plant under irradiation improved favorably. Selected superior progenies isolated in F_2 and F_2M_2 (112) and in F_3M_3 and F_3 generations (135) were advanced to the F_5 generation and evaluated in progeny row trial with two replications. We found that 29 advance breeding lines were superior. Out of 29 lines, 18 originated from irradiated single crosses and five lines from single crosses without irradiation, and six lines from hybridized progenies involving more than two parents revealing the importance of irradiation in creation of desirable variability. The stability analysis involving 29 advanced breeding lines revealed the stable performance of DBS-14, DBS-16, DBS-24 and DBS-26 genotypes over environments with better mean performance for seed yield. Genotype DBS-15 had highest seed protein content (27.20%), which was followed by DBS-12 (26%) compared to high yielding check TAU-1 (19.68%). The large scale trials in different agro climatic conditions, genotype DBS-14 (DU-1) was the most promising genotype with superior seed yield (22.0%) and seed mass apart from its tolerance to stem fly damage compared to adapted cultivar TAU-1 and the genotype is identified for commercial cultivation in the name of DU-1 in Karnataka state and also registered with NBPGR New Delhi for its novel agronomic traits.

Introduction

Mutagenesis in association with recombination breeding offers a viable option to improve adapted variety by crossing with donors of seed yield components there by releasing variability hidden in the conserved gene blocks. In general improvement of blackgram (*Vigna mungo* L. (Hepper)) is limited by lack of variability for the components of seed yield particularly pod length, pod number and seed mass. There are no reports available in the literature on the role of irradiation and recombination in creation of desirable variability in blackgram. Hence, an attempt was made to compare variability generated through different mating schemes and combination of mating and irradiation to improve productivity of recommended varieties in the state of Karnataka.

Department of Genetics and Plant Breeding, College of Agriculture, U.A.S. Dharwad-580 005 India

* Corresponding author. E-mail: stkajjidoni@yahoo.co.in. Present address: Principal Scientist (plant breeding) Agricultural Research Station, Nipani-591 237 India

Materials and Methods

The experimental material comprising of eleven populations which were generated by involving four selected lines in different mating schemes in combination with gamma irradiation. Four genotypes included were Manikya and TAU-1 locally adapted varieties which lack optimum seed size and number of pods per plant respectively. Two selected complimentary donor lines viz., No.169, a line for high pod number (50-55) and No. 216 for seed mass (6.5g) were crossed to generate four single crosses, two three way and one double crosses. Four single crosses were further irradiated with 20 Kr Gamma-rays and advanced to F_2M_2 and F_2 generation. These were evaluated in F_2M_2 and F_2 generation for assessment of desirable variability for seven agronomic traits.

Results and Discussion.

Irradiated populations of single crosses exhibited higher phenotypic coefficient of variability (PCV) and genotypic coefficient of variability (GCV) values for clusters per plant and pods per plant traits. Variability generated by irradiation appeared to add to the recombination variability for two traits such as clusters per plant and pod length [1]. Irradiated single cross (F_2M_2) progenies had higher frequency of superior progenies for pods per plant, 100 seed weight and seed yield per plant compared to other hybridized populations involving two or more than two parents (Table 1).

Table 1. Frequency of superior progenies in F_2 and F_2M_2 generations of blackgram

Progenies	Generation	N° of plants	N° and % superior plants for pods*	Range		
				Pod number	Seed mass (g)	Seed yield / plant (g)
Single cross	F_2	790	142 (18 %)	20-84	3.93-5.64	10.4-27.94
Irradiated single cross	F_2M_2	1100	231 (21%)	20-87	4.03-5.79	10.37-38.23
Three way cross	F_2	740	141 (19%)	22-79	4.01-5.28	11.22-34.60
Double cross	F_2	500	85 (17%)	19-60	4.36-5.43	11.28-29.71

* 100 seed weight and seed yield per plant

Nature of association between pod length and number of pods per plant under irradiation was improved favorably and even it was changed from non significant negative to positive significant in F_2M_2 progenies of a cross TAU-1x169 [2].

Selected superior progenies isolated in the F_2 and F_2M_2 (112) and in the F_3M_3 and F_3 generations (135), which were separately advanced from F_2 , F_2M_2 to F_3 , F_3M_3 by following three different selection methods. All these selected individual progenies were advanced to F_5 generation and evaluated in progeny row trial with two replications, based on their seed yield which yielded more than mean + two standard deviation values, we found that 29 advanced breeding lines were superior. It is interesting to note that when the pedigree of 29 advanced breeding lines was traced

Table 2. Performance of DU-1 (DBS-14) across locations and seasons (Kharif) (Seed yield kg/ha)

Genotype	Dharwad		Bailhongal			Bidar			B'gudi	Gulbarga		Avg.	
	K-03	K-04	K-05	K-02	K-05	K-02	K-03	K-04	K-05	K-06	K-05		K-06
DU-1	1113*	1736*	1875*	805*	464	1107*	1542	986	1020*	826	927*	527	1077.33
TAU-1	825	1357	1424	507	570	754	1381	868	910	833	694	505	885.66
Manikya	790	1083	1179	430	385	684	1104	792	819	778	721	325	757.50
CV %	15.01	12.52	12.10	18	10.6	15.9	10.4	12	8.5	10.18	13.0	18.9	
CD 5%	208	293	310	126	NS	178	173	NS	96.70	NS	156	153.2	

*significant at 5% level of probability

Table 3. Score for insect pests and diseases of promising blackgram genotype

Sl. No.	Entry	Stem fly (%)	Thrips	Aphion infestation		Cercospora leaf spot (0-9)	Powdery mildew (1-5)
				Seeds (%)	Pods (%)		
1	DU-1	30	4.50	22.1	26.0	7	5
2	TAU-1	65	6.25	26.7	31.0	9	5

back, we found that 18 lines originated from irradiated single crosses and five lines from single crosses without irradiation and six lines from hybridized populations involving more than two parents revealing the importance of irradiation in creation of desirable variability.

Further stability analysis of advance breeding lines (29) revealed stable performance of DBS-14, DBS-16, DBS-24 and DBS-26 genotypes over environments with higher mean performance for seed yield and its component traits [3]. The derived advanced breeding lines were evaluated for seed protein content and sugar content across environments. Genotypes exhibited variation for protein content which ranged from 17.9 to 27.2 % when grown at Dharwad location. Genotype DBS-15 had highest seed protein content followed by DBS-12 (26%), compared to high-yielding check TAU-1 (19.68%). Two genotypes DBS-7 and DBS-21 recorded low sugar content in three test environments which can be considered as low flatulence causing lines [3].

Multilocation tests involving these genotypes in different agroclimatic conditions has lead to identification of DBS-14 as most promising

genotype (**Table 2 and 3**) with superior seed yield (22.0%) apart from its tolerance to stem fly damage compared to adaptive cultivar TAU-1. Based on the merits (**Fig. 1**), the genotype was identified for commercial cultivation in the name of DU 1 in Karnataka and also registered with NBPGR New Delhi for its novel agronomic traits.

BIBLIOGRAPHY

1. S.T.Kajjidoni., Roopalaxmi, Salimath.P.M. Comparison of Induced and Recombinational Variability for Improving Productivity in Blackgram. *Indian J.Pulse Research*. **19** 39 (2006).
2. Rooplakshmi,K. Kajjidoni, S.T., Salimath, P.M. Effect of irradiation and mating schemes on nature of association of seed yield and its components in blackgram. *Legume Res*. **26**, 288 (2003).
3. Revanappa, S., Kajjidoni, S.T., Salimath, P.M. Selection of advance breeding lines with low sugar content in blackgram. *Indian J. Genet*. **64**, 243 (2004).

Induced Mutations Affecting Root Architecture and Mineral Acquisition in Barley

P J White^{1*}, A G Bengough¹, I J Bingham², T S George¹, A J Karley¹ & T A Valentine¹

Abstract

Root architecture influences the acquisition of mineral elements required by plants. In general, plants with a greater root/shoot biomass quotient and a more extensive root system acquire mineral elements most effectively. In barley (*Hordeum vulgare* L.) induced mutation has produced commercial cultivars with greater root system size, and genotypes with greater root spread, longer roots and roots with denser root hairs. Work is in progress investigating whether these phenotypes improve the acquisition of mineral elements and, thereby plant growth and grain yield.

Root architectural requirements for mineral acquisition by plants

Plants require at least 14 mineral elements to complete their life cycles. These include six macronutrients (N, K, P, Mg, Ca, S), which are present in relatively large concentrations in plant tissues (g kg⁻¹ dry weight) and several micronutrients (Fe, Zn, Mn, Co, Cu, B, Cl, Mo), which are present in smaller amounts (mg kg⁻¹ dry weight). Tissue concentrations of these elements must be maintained within a certain range, since any deficiency can limit plant growth, and an excess can be toxic. In most areas of the world, agricultural production requires the application of fertilizers to supply a crop's requirement for essential mineral elements. However, commercially viable sources of most mineral elements are diminishing, and the unbalanced or excessive application of fertilizers can lead to environmental problems. Therefore, it is important to develop management strategies and crops that utilize our mineral resources most efficiently.

Mineral elements are acquired from the soil solution by the plant root system, and the acquisition of each mineral element has its own challenges. Root architecture influences most the acquisition of mineral elements that are required by plants more rapidly than they arrive at the root's surface, and for which the root system must forage in the soil [1], [2]. These mineral elements include P, K, Fe, Zn, Mn and Cu [3]. The ability of the root system to proliferate rapidly throughout the soil, especially in areas where these elements are locally abundant, is an advantage, as are the release of exudates and enzymes that solubilize essential mineral elements and the fostering of beneficial associations with symbiotic fungi and microbes [1], [4], [5], [6].

Barley (*Hordeum vulgare* L.) is a high yielding cereal crop that is cultivated worldwide for animal feed, human food, malting, brewing, and distillation. Its root system is comprised of between three to eight seminal roots, which arise from the embryo, and a greater number of adventitious (nodal) roots that originate from the base of the main stem and tillers during development [7]. It is thought that the ability of a barley plant to acquire mineral elements might be improved by it having a greater root/shoot biomass quotient [8], [9], a more extensive root system [1], [8], longer, thinner roots with more root hairs [10], [11], [12], [13], a greater number and even spread of seminal roots [14],

[15] and the ability to proliferate lateral roots in mineral-rich patches [16]. It has been demonstrated that there is considerable variation in these parameters between barley genotypes. For example, wild barley has fewer seminal roots with a narrower spread [15], and invests less biomass in its root system [17] than cultivated genotypes. These observations suggest that root traits have been selected, albeit inadvertently, for particular environmental conditions during the domestication and improvement of the barley crop.

Root traits associated with the *sdw1* and *ari-e.GP* mutations

Induced mutation increases the genetic variation within a species and this technique has a long history of producing barley genotypes with agronomically beneficial traits. The FAO/IAEA Mutant Varieties Database lists 303 barley cultivars that have been produced through induced mutation (<http://www-mvd.iaea.org/MVD/default.htm>, accessed 21st May 2008). Among these cultivars are the semi-dwarf genotypes Diamant (*sdw1* = *denso*, chromosome 3H), which was generated from the Czech cultivar Valticky using X-ray irradiation and released in 1965 [18], and Golden Promise (*ari-e.GP* = *GPert*, chromosome 5H), which was generated from the Maythorpe cultivar using Gamma-ray irradiation and released in 1966 [19], [20]. Other important cultivars bearing mutations in these genes include Triumph (*sdw1*), Prisma (*sdw1*), Derkado (*sdw1*), Optic (*sdw1*), Tocada (*sdw1*), Westminster (*sdw1*) and B83-12/21/5 (*ari-e.GP*).

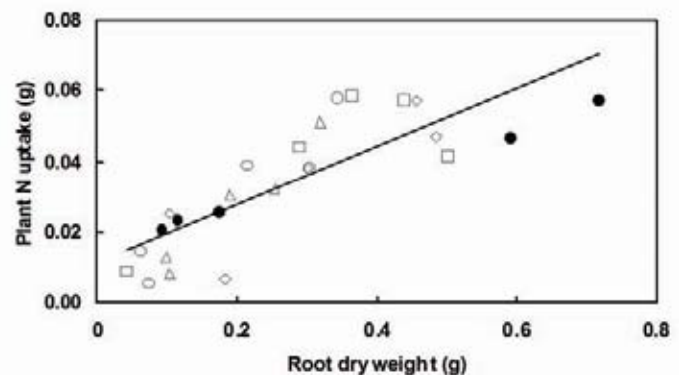

Figure 1 The significant positive relationships ($R^2=0.685$, $P<0.0001$, $n=25$ individual plants) between plant N uptake and root system size at grain maturity among five barley cultivars grown in the glasshouse at SCRI in 1m long tubes filled with a grit-sand-gravel mixture and irrigated daily with a water flush followed by a standard liquid nutrient application. Genotypes included a tall cultivar (Kenia, filled circles), and cultivars bearing the dwarfing gene *sdw1* (Derkado and Westminster, open circles and triangles, respectively) or *ari-e.GP* (Golden Promise and B83-12/21/5, open squares and diamonds, respectively). In this experiment, grain yield was positively correlated with both plant N uptake and root dry weight (A.J. Karley, data not shown).

The *sdw1* and *ari-e.GP* mutations were originally selected because they reduce plant height and increase grain yield, but they also affect root traits such as root length, root weight and nitrogen isotope dis-

¹ Scottish Crop Research Institute, Dundee, United Kingdom

² Scottish Agricultural College, Edinburgh, United Kingdom

* Corresponding author. E-mail: philip.white@scri.ac.uk

crimination [21], although the manifestation of their effects on root traits is influenced greatly by the environment. It has been observed that genotypes bearing the *sdw1* or *ari-e.GP* mutations often have larger root systems than non-dwarf genotypes when grown in the field [17] and that both mutations are present in chromosomal regions (QTL) affecting root system size among genotypes of a Derkado x B83-12/21/5 double haploid mapping population [17], [22]. The *sdw1* mutation was associated with increased size of both seminal and adventitious root systems in the Derkado x B83-12/21/5 population, particularly during the early stages of plant development [17], [22]. However the *ari-e.GP* mutation was associated with fewer roots, shorter roots and lesser root spread in 10-day-old seedlings [22], lower root mass of six-week-old seedlings, and reduced size of the root system of field grown plants at grain filling [17]. Other chromosomal regions associated with total root length, root number and root spread have been identified in the Derkado x B83-12/21/5 mapping population [17], [22] and in a collection of mutants backcrossed into the Bowman cultivar [14].

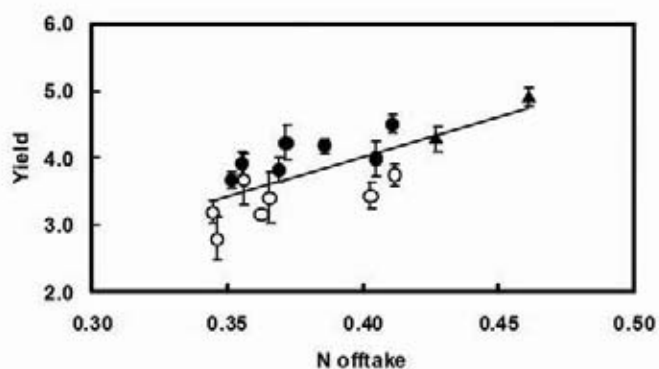

Figure 2 The significant positive relationship ($R^2=0.549$, $P=0.001$, $n=16$ genotypes) between grain yield and N offtake (kg kg^{-1} supplied) among 16 barley cultivars grown in the field at SCRI in 2006. Genotypes included tall cultivars (open circles) and cultivars bearing the dwarfing gene *sdw1* (filled circles) or *ari-e.GP* (filled triangles). Yield data are shown as means \pm standard error of four replicates.

In glasshouse (Fig. 1) and field experiments (Fig. 2, [17]), N uptake and grain yield have been positively correlated with root system size. When grown in field plots, and supplied with ample N fertilizer, cultivars bearing the *sdw1* or *ari-e.GP* mutations generally have higher grain yields than taller genotypes with a comparable N offtake, and cultivars bearing *ari-e.GP* mutation often have higher offtakes of N and other mineral elements (Fig. 2). However, cultivars bearing the *sdw1* or *ari-e.GP* mutations can have lower concentrations of mineral elements in their grain, despite their greater offtake of mineral elements, which is possibly a consequence of yield dilution ([21] and I.J. Bingham and P.J. White, unpublished data). The *ari-e.GP* mutation has also been found to decrease shoot Na concentrations and increase salt tolerance [19], [23].

Screening a collection of induced mutants in the Optic cultivar

A population of induced mutants was produced in the Optic cultivar by the Scottish Crop Research Institute using ethyl methane sulphonate [24], [25]. A structured mutation grid for exploiting TILLING (Targeted Induced Local Lesions IN Genomes) has been developed for this population, which consists of >20,000 M_3 families. This collection can be used in different ways to identify genotypes with increased efficiency to acquire mineral elements from the soil. One approach (forward genetics) is to screen these collections directly for an improved phenotype and, subsequently, to identify the genetic origin of the phenotype. The other approach (reverse genetics) is to use the techniques of molecular biology to identify accessions with mutations in target genes known to

influence the acquisition of mineral elements beneficially. This population has been screened for rooting phenotypes and their consequences for the acquisition of mineral elements have been investigated.

Early seedling root growth is an important agronomic characteristic, since it accounts for much of the N and P absorbed by a barley plant. The Optic collection was screened for differences in root traits from wildtype plants three days after germination (Fig. 3). The frequency of occurrence of mutant lines with altered root traits was high, but comparable to other collections [26], [27], [28]. The root phenotypes of several mutant lines were validated using a two dimensional root observation chamber specifically designed to measure rooting traits of young barley seedlings, such as root length, elongation rate, longest root, deepest root, seminal root number, and angular spread of roots (T.A. Valentine, unpublished data). These lines will be used for future physiological studies.

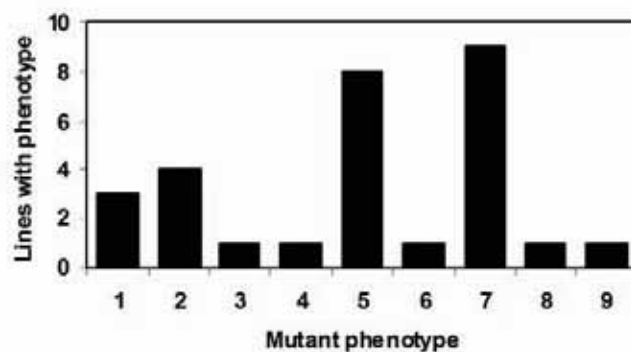

Figure 3 The frequency of specific root phenotypes among mutant lines of the Optic collection. The root phenotypes scored in comparison with the wild type were (1) long roots, (2) short roots, (3) reduced number of roots, (4) highly gravitropic roots, (5) agravitropic or curly roots, (6) more dense root hairs, (7) fewer or shorter root hairs, (8) presence of pigmentation, and (9) visible necrosis. Seeds were germinated on moistened filter paper and seminal roots were observed after three days. Thirty mutant lines with altered root characteristics were recorded from a screen of about 500 lines. (Data courtesy of W.T.B. Thomas, B.P. Forster and J. Lyons, SCRI)

Selected mutants from the Optic collection have also been screened in glasshouse and field trials. Accessions from the Optic collection with contrasting rooting traits (wild type, hairless, dense haired, long rooted and highly geotropic phenotypes) were grown to maturity in the glasshouse in 1 m long tubes filled with a grit-sand-gravel mixture and irrigated daily with a water flush followed by a standard liquid nutrient application. No significant differences in plant dry matter allocation were observed between these genotypes except for seed dry weight, which was significantly smaller in the hairless mutant compared with the wild type. However, the ability to acquire mineral elements was again correlated with the size of the root system. Root dry mass tended to be smaller in the mutant lines, although this was not significant.

Conclusions and Perspectives

The available evidence suggests that the acquisition of mineral elements by plants is related to the ability of their root systems to explore the soil. Mutants can be generated with root systems that exploit the soil better, acquire greater quantities of mineral elements, and produce greater yields on impoverished soils. In the coming years it is planned to screen the SCRI Optic mutant collection for multiple efficiencies in the acquisition and utilization of mineral elements and water. Current projects include screening for traits, and identifying genes, to improve the acquisition of N, P, Zn and Mn, improving the uptake and efficient use of water, and reducing the entry of toxic elements to the food chain. Knowledge of the genes impacting the acquisition of mineral elements can be used to develop genotypes of other common crops that can be

deployed in extreme environments: to increase their ability to grow on resource poor soils, to increase their accumulation of minerals required for animal nutrition and to reduce their accumulation of toxic elements. These outcomes should increase the sustainability of agriculture both at a subsistence and industrial level, and improve the health of populations by increasing the nutritional content and reducing the content of toxic elements in food consumed.

ACKNOWLEDGEMENTS

This work was supported by the Scottish Government Rural and Environmental Research and Analysis Directorate (RERAD). We thank Drs W.T.B. Thomas, B.P. Forster and J. Lyon for mutation frequency data.

BIBLIOGRAPHY

- White, P.J. *et al.* Proceedings of the International Fertilizer Society 568. Genetic Modifications to Improve Phosphorus Acquisition by Roots. *IFS*, York (2005).
- De Dordot, S. *et al.* Root system architecture: opportunities and constraints for genetic improvement of crops. *Trends Plant Sci.* **12**, 474-481 (2007).
- Barber, S.A. *Soil Nutrient Bioavailability: A Mechanistic Approach*. Wiley, New York (1995).
- Baligar, V.C. *et al.* Nutrient use efficiency in plants. *Commun. Soil Sci. Plant Anal.* **32**, 921-950 (2001).
- Gahoonia, T.S., Nielsen, N.E. Root traits as tools for creating phosphorus efficient crop varieties. *Plant Soil* **260**, 47-57 (2004).
- Rengel, Z., Marschner, P. Nutrient availability and management in the rhizosphere: exploiting genotypic differences. *New Phytol.* **168**, 305-312 (2005).
- Briggs, D.E. *Barley*. Chapman Hall, London (1978).
- Ozbas, M.O., Çagırgan, M.I. Variability and relationships of root traits in a subset of induced barley mutant collection. *Cereal Res. Commun.* **32**, 119-126 (2004).
- Hermans, C. *et al.* How do plants respond to nutrient shortage by biomass allocation? *Trends Plant Sci.* **11**, 610-617 (2006).
- Gahoonia, T.S., Nielsen, N.E. Variation in root hairs of barley cultivars doubled soil phosphorus uptake. *Euphytica* **98**, 177-182 (1997).
- Gahoonia, T.S., Nielsen, N.E. Phosphorus (P) uptake and growth of a root hairless barley mutant (*bald root barley, brb*) and wild type in low- and high-P soils. *Plant Cell Environ.* **26**, 1759-1766 (2003).
- Gahoonia, T.S., Nielsen, N.E. Barley genotypes with long root hairs sustain high grain yields in low-P field. *Plant Soil* **262**, 55-62 (2004).
- Loes, A.K., Gahoonia, T.S. Genetic variation in specific root length in Scandinavian wheat and barley accessions. *Euphytica* **137**, 243-249 (2004).
- Gordon, D.C. *et al.* A phenotypic screen for genetic analysis of barley seedling root traits. *Aspects Appl. Biol.* **73**, 81-84 (2005).
- Bengough, A.G. *et al.* Gel observation chamber for rapid screening of root traits in cereal seedlings. *Plant Soil* **262**, 63-70 (2004).
- Drew, M.C. Comparison of the effects of a localized supply of phosphate, nitrate ammonium and potassium on the growth of the seminal root system, and the shoot, in barley. *New Phytol.* **75**, 479-490 (1975).
- Chloupek, O. *et al.* The effect of semi-dwarf genes on root system size in field-grown barley. *Theor. Appl. Genet.* **112**, 779-786 (2006).
- Mlcochova, L. *et al.* Molecular analysis of the barley cv. 'Valticky' and its X-ray-derived semidwarf-mutant 'Diamant'. *Plant Breeding* **123**, 421-427 (2004).
- Forster, B.P. Mutation genetics of salt tolerance in barley: An assessment of Golden Promise and other semi-dwarf mutants. *Euphytica* **120**, 317-328 (2001).
- Walia, H. *et al.* Array-based genotyping and expression analysis of barley cv. Maythorpe and Golden Promise. *BMC Genomics* **8**, 87 (2007).
- Ellis, R.P. *et al.* Phenotype/genotype associations for yield and salt tolerance in a mapping population segregating for two dwarfing genes. *J. Exp. Bot.* **53**, 1163-1117 (2002).
- Forster, B.P. *et al.* Genetic controls of barley root systems and their associations with plant performance. *Aspects Appl. Biol.* **73**, 199-204 (2005).
- Pakniyat, H. *et al.* Comparison of salt tolerance of *GPert* and non-*GPert* barleys. *Plant Breeding* **116**, 189-191 (1997).
- Caldwell, D.G. *et al.* A structured mutant population for forward and reverse genetics in barley (*Hordeum vulgare* L.). *Plant J.* **40**, 143-150 (2004).
- Forster, B.P. *et al.* The barley phytomer. *Ann. Bot.* **100**, 725-733 (2007).
- Engvild, K.C., Rasmussen, S.K. Root hair mutants of barley. *BGN* **34**, 13-15 (2004).
- Nawrot, M. *et al.* Mutational analysis of root system characters related to agronomic performance in barley. In: *Mutational Analysis of Root Characters in Food Plants*, IAEA, Vienna, 23-38 (2006).
- Janiak, A., Szaejko, I. Molecular mapping of genes involved in root hair formation in barley. *Euphytica* **157**, 95-111 (2007).

Current Status and Research Directions of Induced Mutation Application to Seed Crops Improvement in Vietnam

M Q Vinh^{1,3,*}, D K Think², D T Bang¹, D H At¹ & L H Ham¹

Abstract

Nuclear techniques and chemical mutagens have been applied in Vietnam since the 1970's in order to improve seed crops as rice, soybean, maize, groundnut, many mutant varieties were approved as national varieties and some promising regional lines. Main direction and methods using in varietal improvement in Vietnam were exploitation of gene resources, using genetic methods consisting of hybridization, mutation, gene transformation to create crops having high yield, good quality, tolerance to diseases and adverse conditions. Up to the year 2007, according to preliminary statistics, in Vietnam 50 mutant varieties were created (as IAEA database, having 43 mutant varieties created, Vietnam is being the ninth of mutant breeding' achievement record in the world). Among of those, seed crops occupied 47 varieties: rice was 32 varieties, soybean was 11, maize was 2, and peanut was 2. At AGI 17 rice mutant varieties, 11 mutant varieties of soybean were bred and approved by Ministry of Agriculture and RD as national and regional varieties. At present, about 15 % of Vietnam rice area annually cultivated by mutant varieties, some best mutant varieties become one of the top 5 varieties for export and grown recently more than 300,000 ha per year in South, more than 50% of soybean cultivated area occupies by mutants contributing worthily to increasing cereal productivity of Vietnam.

Introduction

For a long history, Vietnam still had lacked a food, in period of 1970 – 1980, every year Vietnam had to import 2 – 3 million tons of cereals for the need of domestic consumptions.

After 20 years of Renovation (1988 – 2007), production of major cereals (rice, corn, soybean, groundnut) have been increased by 2.5 – 4.0 times, yield – 2 times, consequently national food security has been already established in the whole country. In 2007 Vietnam exported 4.3 million tons of rice keeping the world's second-largest exporter. However Vietnam still had to import about 0.7 million tons of maize, 2.5 million tons of soybean. (Table 1). To solve with this problem Vietnam has many kinds of means to promote cereals production, in that genetic improvement is considered as a first priority.

Brief history of mutation breeding in Vietnam

Nuclear techniques and chemical mutagens have been applied in Vietnam since the 1970's in order to improve crops. Many mutant varieties have been planted in field of large area. A lot of agriculture research institutes have cooperated with Vietnam Atomic Energy Commission (VAEC), International Atomic Energy Agency (IAEA) and other organizations to conduct mutation breeding in varieties such as rice, maize, soybean, groundnut and other ornamental and fruit plants, many of which were approved as national varieties and some promising regional lines. Among them Agricultural Genetics Institute (AGI) is a specific

research center, which used to be one of the earliest institutes applying nuclear techniques to create new mutant varieties by gamma rays, X rays, and the other mutagenic chemicals and had many successes in this field. Main methods using in varietal improvement in Vietnam were exploitation of gene resources, using and genetic methods consisting of hybridization, mutation, gene transformation to create crops having high yield, good quality, tolerance to diseases and unsuitable climate conditions.

Up to the year 2007, according to preliminary statistic, in Vietnam 50 mutant varieties were created (as IAEA database, having 43 mutant varieties created in 2007 Vietnam is being the ninth of mutant breeding achievement record in the world), among of those seed crops occupied 47 varieties, rice occupied 32 varieties, soybean 11, maize 2 and peanut 2 (Table 2, Appendix 1).

Table 1. Some achievements in seed crops production after 20-years of Renovation (1988 – 2007) in Vietnam (*)

Seed Crops	Years	Total area (Thous. Ha)	Production (mill. tons)	Yiel (tons/ha)
Paddy rice	1985	5,603.9	15.8	2.78
	2007	7,210.0	35.994	4.99
Corn	1985	587.1	0.86	1.47
	2007	1,067.9	4.11	3.58
Soybean	1985	102.1	0.0791	0.78
	2007	190.1	0.2755	1.47
Groundnut	1985	212.7	0.2024	0.95
	2007	254.6	0.5051	1.98

(*) Source: State statictical office 1985 - 2007

Table 2. Mutation derived varieties in the world (FAO-IAEA Mutant Variety Database, 2007, Apr.)

Country	Var. No	Rank	Country	Var. No	Rank
China	638	1	Brazil	36	13
India	272	2	Slovakia	35	14
Japan	232	3	UK	34	15
Russia+USSR	214	4	Bangladesh	27	16
Netherland	176	5	Sweden	26	17
Germany	176	6	Cote d'voi	26	17
USA	128	7	Guyana	26	17
France	43	8	Belgium	23	20
Vietnam	42 (50*)	9	Iraq	23	20
Pakistan	42	9	Denmark	22	22
Bulgaria	38	11	Austria	21	23
Canada	37	12	Rep/of Korea	19	24

(*) Remark: By Vietnam primary data

¹ Agricultural Genetics Institute (AGI), Hanoi, Vietnam

² Institute of Agricultural Sciences for Southern Vietnam (IASSV), Ho Chi Minh City

³ Vietnam Radiation Medical and Biology Association (VRMBA)

* Corresponding author. E-mail: maiquangvinh@gmail.com

Main achievements of nuclear application on mutation breeding in rice in Vietnam

Agricultural Genetics Institute (AGI) is a specific research center, one of the institutes apply early nuclear techniques to create new mutant varieties by gamma rays, X rays, and the other mutagenic chemicals and we had many successes in this field (**Appendix 1**)

Rice is the major cereal and the staple food in Vietnam 75% starch quantities for daily meals of almost people. At present, 4.5-5 million tones of normal white rice from the total production 36 million tons are exported, reached up to 1.5 billion USD (2007), mainly for Asian market with competitive price (ca. ~260-275 USD/t), and very limited quantities of rice with high quality and glutinous rice (<100.000 t) are included, but mainly for Japan market with increasing price (>420 USD/T).

The National Strategy Project on Rice Breeding is identified for yield and quality improvement to increase the income of rice producing farmers and export price to support the food security of the country with the increasing population (ca. 90 mil. persons) and to meet the higher requirements of many markets opened in Europe, Middle East and Africa.

Recent development of combination of nuclear techniques with biotechnology, known as *in vitro* mutagenesis and manipulation, and molecular markers has been effectively introduced for the induction of new and novel types of crop varieties.

The used materials were local lines (Cuom, Chiem bau, Tam thom, Nang thom, Nang huong, Te etc.) and the varieties presently used in the crop productivity (C4-63, A8, CR203, Khang dan, IR64, IR50404). The treatment methods were dry seeds with different radiation doses (Gamma ray, X-ray with 80, 100, 150, 200, 250Gy, useful doses were 100, 120, 200Gy); the others were germinated seeds with radiation doses of 20, 30, 40, 80Gy, useful doses were 30, 40, 60Gy).

In the decades of 1980-1990 of last century, AGI has created 17 national, regional mutant varieties, particularly the varieties having high yield and good resistance. DT17 and DT18 are submerged tolerance, salinity tolerance varieties comprising CM-1, CM-2, CM-3, cold tolerance varieties including DT-10, DT11, DT13, Khang dan Dot bien, DT37, DT3 having short growth, good quality, high yield and good resistance. In 2007, licence of mutant variety Khang Dan Dot bien (origin is KD18) was successfully transferred on Centural Seed Company. These varieties are preponderance in the Northern provinces and every year occupies about 40% of cultivated area (about 0.4 million ha per year).

In present, some of the best mutant varieties such as VND95-19, VND95-20, VND404, VND99-3, TNDB-100, THDB created by Institute of Agricultural Sciences for Southern Vietnam (IAS) and Cuu Long Delta Rice Research Institute (CLRRI) have been released for large-scale production in Mekong River Delta. Nowadays, these varieties were planted in 3.0 million hectares, counted for 10 - 15 per cent annual area. Among of those, VND95-20 has become one of the top 5 varieties for export and grown recently more than 300,000 ha per year in Southern Vietnam. Due to significant contribution for socio-economic development, VND95-20 was awarded National Prize of Science & Technology by Vietnam Government.

In combination with hybridization method, some mutants gave promising recombinants in aroma, tolerance to BPH, Grass Stunt Virus (GSV) & Ragged Stunt Virus (RSV) diseases. Selected varieties as VN 121, VN 124, VN24-4 are released into production in recent time [5,6].

Problems need to be stressed for research directions on rice

In Vietnam, the most constraints to the crop production, especially rice, fruits, legumes by far caused by biotic, particularly brown plant hopper, and abiotic stresses such as salinity, drought, acid-sulphate and other adversely environmental factors.

The elite rice varieties such as Khang Dan, Q5, Tam thom, Basmati have been popularly cultivated in Vietnam because of their stability of

high yields, very wide adaptability. But the major constrains facing production of the varieties for both domestic and export demand are their low quality not only in cooking, edibility and nutrition but also in grain appearance.

To raise grain quality it is necessary to improve related characteristics, such as: cooking and edibility relating to amylose content, gelatinization temperature; nutrition relating to protein content; grain appearance relating to grain length, grain width, width-length ratio and translucency of endosperm.

The major constrains of grain quality can be overcome by radiation-induced mutation.

To improve plant type of traditional aromatic rice varieties it is mainly necessary to reduce their long duration of growth and responses to N-fertilizers, to increase grain yield. To remove their photoperiod-sensitivity, that partly relates to so long durations of growth, going along with maintain and improve their characteristics in aroma and grain quality both for domestic consumptions and export demands.

The Programme entitled "*Radiation-induced aromatic rice varieties for high yield and good quality*" has been started June 2000, applying irradiation treatments with γ rays of ^{60}Co on traditional aromatic rice cultivars with some special characters, e.g. grains translucent, fragrant, fine, rich in protein but short and small; good tolerance, but without improved plant type, e.g. over 160 cm in height, lodging, 160-180 days in growth duration and low yield (<3 t/ha),... Moreover, the conventional crossings are quite limited for this group of rice varieties.

Therefore in this cycle our programme during 5 years to come is focused on some following pivotal tasks as following:

- Development of rice varieties with high yield (>5.5 t/ha), short growth duration (ca. 90 - 120 days), good quality for export and domestic consumptions at high grades.
- Improvement of drought, salinity and disease tolerance of rice varieties.

The doses of irradiation of 60-90Gy were applied for germinated seeds of Aromatic Tam and Basmati 370 (from Pakistan), respectively, since 2001-2002 from broad spectra of variants a lot of novel mutants have successfully been selected for improved criteria, such as: no photoperiodic sensitivity (suitable with any crop seasons in the year), short growth duration (90-100 days), stiff and short plant type (90-110 cm),... and yields more than twice higher than original variety (6-7,5 t/ha).

During 5 years of selections and multi-regional trials, some pure line mutants (at M8-M10) with high quality grains meeting export demands of aromatic rice. Over 4 crop seasons in many provinces both in Mekong and Red River Deltas, their consistency has been established.

In Northern Vietnam, some pure mutant lines of Tam Aromatic rice has been isolated and tested in National Programme as follows: HP-101 (HN-PN-103-1), HN-PN-103-3, HN-PN-103-4 (selected in Institute of Food & Cereal Crops) and TL4 (selected in Institute of Agricultural Genetics); produced at large scales in 3 provinces.

In Southern Vietnam, 5 pure mutantlines: TDS3 (Tám 28-9-4), E 4, E 6 and BDS have been enlarged areas of cultivation in provinces: Soc trang, Dong nai, Long an, Daknong, An giang,... They are well improved in grain quality, e.g. length (>7-7,5 mm), quite translucent and their fragrance is still maintained as required for export. Highest yields in large scaled-production are recorded in An Giang (7,5-10 t/ha) and approved by almost rice farmers at Field Symposia (9/2004, 1/2005, particularly in January and June 2006), and appreciated by breeding experts.

Main achievements of nuclear application on soybean mutation breeding in Vietnam

In Vietnam, soybean (*Glycine max* (L.) Merr.), an important food and industrial crop, provides the protein need and oil for human being, the food for animals and the materials for industry. Although spreading of soybean cultivated area in Vietnam still has a large potency, but it increases quite slowly. In 2007, the soybean planted area was reached

only to 190,100 ha with the yield of 1,47 ton/ha (63.2% average world yield), and the soybean produce was 275.5 thousand tons, meanwhile in 2007, Vietnam had to import 2.5 million tons (equivalent of dried seed) from foreign countries. Up to 2015, Vietnam intends to import 3.5 – 4.0 million tons/year of soybean.

Thus the problem, which made by the fact of production and market to Vietnamese soybean breeders was selecting and creating soybean varieties with short growth duration (75-100 days), high yield (2.0 -3.5 tons/ha), good seed quality, tolerant to drought, resistant to diseases, adapted to crop pattern and ecological regions in the whole country.

In Vietnam, Tran Dinh Long (1990) selected M-103 soybean variety by using EI. At AGI, the researcher group, led by Mai Quang Vinh et al (1985, 1987, 1990, 1995, 1998, 2000, 2002, 2004, 2007), has been carrying out the research on the application of induced mutation and bred 9 mutant soybean varieties and 10 other promising varieties and lines.

From 1980 to 2006, 31 varieties and lines were used, consisting 6 local cultivars: Coc chum, Quang hoa, Dau lang, Cuc luc ngan, Xanh bac ha, Cuu long Delta. 7 bred or introduced varieties: DT-70, DT-76, DT-94, K7002, K6871, IS-011, DT-80. 11 mutant varieties and lines: M-103, DT-83, DT-84, DT-90, DT-94, DT-95, DT-96, DT-99, MV1, MV4, AK04... Treatment Methods: Dried seeds treated with Gamma ray Co⁶⁰ with doses of 70, 100, 150, 180, 200, 220Gy, Chemical mutagens: EI, DES, EMI, NMU, DNMU, DEU with concentrations of 0.02, 0.04, 0.06, 0.08% in 2, 4, 6 and 8 hours; combining treatment by Gamma ray Co⁶⁰ with dose of 100Gy and chemical mutagen Ethylenimine 0.008, 0.02 and 0.05%. Treated in *pre-embryo phase* and *zygote cell in flowering phase* by Gamma ray Co⁶⁰ with the doses of 100, 200 300Gy.

In twenty years (1987 – 2007), 4 National, 5 regional production, 10 promising mutant and cross-mutant soybean varieties and many other valuable soybean lines, selected by AGI, were adopted by Scientific Committee of MARD as national varieties, among of those DT84, DT99, DT96 are 3 varieties occupied the largest-scale of soybean cultivated area thanks to their grown ability of three crops per year, broad adap-

tation, good tolerance to hot, cold temperature and good resistance to diseases. At present Vietnamese mutant soybean varieties occupy more than 50% of soybean cultivated area in the whole country (more than 100 thousands ha per year), contributing worthily to increasing soybean productivity of Vietnam from 0.78 tons/ha (1985) to 1.47 tons/ha (2007), cultivated area from 102.1 thousands ha (1985) to 190.1 thousands ha (2007), production increased three times, resulting in the productivity of Vietnamese soybean is ranked as the highest in South-East Asian countries (Table 3).

In Vietnam, after the results of using induced mutation combined with crossing for soybean varietal improvement, the mutation breeding works could:

1) Improve yield component factors:

Mutant variety DT-83 have the yield higher than that of the original variety Coc chum 70%, plant higher than 50%.

Mutant variety DT-84 have the yield higher than that of its parent 30-40%.

Mutant variety DT-95 have the yield higher than that of original variety AK-04 15-20%.

2) Improve seed quality and color.

Change from blue seed to yellow seed: DT-83 and DT-95 varieties have yellow seed meanwhile original varieties Coc chum and AK-04 have blue seed.

Seed size: P1000 seeds of DT-83 variety heavier than that of Coc chum 60% (86 gr. to 138 gr) the mutant variety DT2003 (Line NC12, improved from DT-83) has P1000 seeds of 160gr. The DT-90 variety has P1000 seed heavier than that of its parent 20-30%.

Protein content increased +6.46 to -7.7% in mutant lines from Coc chum, 41.15% instead 39.50%.

Improve the cracked seed coat character in D.3/33 (DT-80 x DT-76) and breed DT-84 with less cracked seed coat character.

Table 3. The characteristics of mutant soybean varieties and hybrid recognized in 1987-2008

Variety & line	Growth duration (days)	Plant height (cm)	Flower color	Average yield (ton/ha)	P1000 seed (gr.)	Seed color	Crop
DT-83 (*)	90	40-50	Violet	13-27	138	Yellow	Sp-Sm
Cochum(origin)	88		Violet	8-18	86	Blue	Sp-Sm
DT-84 (*)	85-90	45-50	Violet	15-35	160-180	Yellow	Sp-Sm-W
DT-80 (origin)	85-105	40-60	Violet	14-27	120-140	Yellow	Sp-W
DT-76 (DH4)(Con)	89	40-45	Violet	12-25	180-200	Yellow	Sm
DT-90 (*)	95-100	45-50	White	15-30	180-200	Yellow	Sp-Sm-W
K.7002x	90-95	45-50	White	15-30	150-180	Yellow	Sp-W
Coc chum	88	45-50	Violet	8-18	90	Blue	Sp-Sm
DT94 (**) (DT83 x DT84)	90-95	45-55	Violet	15-30	150-160	Yellow	Sp-Sm-W
DT-95 (*)	90-103	50-80	Violet	15-30	160	Yellow	Sp-Sm-W
AK-04 (origin)	95-100	40-55	Violet	15-20	150-180	Blue	Sp-Sm-W
DT-96 (**) (DT84 x DT90)	95-98	45-50	Violet	15-30	180	Yellow	Sp-Sm-W
DT-99 (*) (IS-011 x Cuc)	70-80	35-45	Violet	13-24	150	Yellow	Sp-Sm-W
AK-06 (DT.55)	85-95	40-60	White	17-25	165-180	Yellow	Sp-Sm-W
DT-74 (origin)	95-100	40-60	White	15-23	160-170	Yellow	Sp-W
DT2001(**) (DT84 x DT83)	88-100	45-70	Violet	18-40	170	Yellow	Sp-Sm-W
DT2003(*) DT83 (origin)	88-98	40-60	Violet	18-35	160	Yellow	Sp-Sm-W
DT2008 (*) D.158 (origin)	100-120	50-80	Violet	25-40	160	Yellow	Sp-Sm-W

Note: (*) Variety acquired directly from mutation - (**) Hybrid variety from mutant parent
Origin: Original variety; Con: Control variety; Sp: Spring; Sm: Summer; W: Winter

3) Improve temperature and disease resistance:

The varieties DT-84, DT-90, DT-94, DT-95, DT-99, AK06 (DT55): can be cultivated in 3 crops/year in Northern provinces of Vietnam by combining heat and cold tolerance of their parent.

AK-06 variety can be planted in 3 crops in North Vietnam after improving non-tolerance to heat character of the original variety V-74.

Mutant DT95 variety showed resistance to 7/10 trains of rush (*Phakopsora pachyrhizi* Sydow), it's AK04 (origine) are susceptible to rush [7].

Mutant DT2008 showed high resistance to 3 kinds of diseases: rush, downy mildew, bacterial posture and drought tolerance.

4) Improve growth duration:

Mutant line DT95/049 (DT95B) of DT-95 variety shortened 8 days of growth duration.

From the practical research on mutation process and mutant soybean variety breeding at AGI, we come to some conclusions as following [3,4]:

The dry seeds newly harvested, stored less 3 months, having high survival rate, can tolerate to high dose or concentration of mutagens treated. They can generate more variations/mutants than the long-term stored seeds.

The genetic sensibility ability of the local varieties is higher than that of the selected and introduced varieties. Mutant frequency of local varieties usually was lower.

It is possible to use cytological methods, meioses index, chromosomal aberration frequency combined with physiological methods (germination rate, survival rate, chlorophyll variation frequency, optimal concentration and dose of treatment) to obtain the most useful mutation spectrum.

The effective concentrations of mutagen: EI-0.02-0.04%; NMU, NDMU: 0.06%; EMS, DEU, DES: 0.02-0.06% in 6-8 hours pH: 6 or 7, doses of radiation: 15-18Gy. Especially the treatment with EI (concentration 0.02-0.04%) combined with gamma ray 10Gy can give many valuable mutations in soybean.

The use of induced mutation can improve some economic and morphological characters in soybean, and improve economic characters of local varieties in keeping valuable characters of the original varieties.

Some mutant soybean varieties selected by VAGI which are widely applied in Vietnam:

DT-84: National, famous Vietnam soybean mutant, created by Gamma rays Co⁶⁰- 18Gy + F3 (DT80/DH4) adopted by MARD in 1994, Nowadays, DT84 have occupied 40% of 180,000 ha soybean areas of Vietnam and 80 - 90% soybean areas of many north provinces. Grow duration: 84 - 90 days, Yield: 1.8 - 3.5 tons/ha, protein content: 41%, wide adaptability, hot and cold tolerance, can be cultivated in 3 crops/year. DT84 was awarded national prize of Science & Technology VIFOTEC - 2005.

DT96: National variety, hybrid between two mutants (DT90/DT84), moderate drought tolerant, rush resistance, wide adaptability, suitable cultivated in 3 crops/year, growth duration: 88 - 100 days, yield: 1.8 - 3.6 tons/ha, high protein content (43 - 45%), DT96 was adopted by MARD in 2004.

DT2008: Newly selected, prospective variety, created by gamma rays Co⁶⁰- 18Gy + F4 (DT2001/IS10), drought tolerant, thermo-tolerant, resistant to rush, rush, downy mildew, bacterial posture. wide adaptability, suitable cultivated in 3 crops/year, grow duration: 110 - 120 days, high-yielding: 2.5 - 4.0 tons/ha.

Conclusion and Suggestions

After more than 30 years of close cooperation with IAEA, FAO and other foreign organizations, Vietnam recorded remarkable achievements in application of induced mutation breeding for seed crops improvement. About a 50 mutant varieties were created, among of those seed crops

occupied 47 varieties (rice was 32 varieties, soybean - 11, maize - 2 and peanut - 2). These varieties occupy more than 50% of cultivated area of Vietnam mutant soybean and 15 % by mutant rice, contributing significantly to increasing cereal productivity of Vietnam.

Our research experienced that improvement of seed crops by inducing mutation, especially by radiation mutation breeding was effective method. In the coming years plant breeding directions will be close combination between conventional (mutation, hybridization) with modern biotechnology methods to reach the goal increase of plant breeding effective, to serve a The National Strategy Project on Food Security.

BIBLIOGRAPHY

1. Bui Huy Thuy, Do Huu At, Dao Thanh Bang *et al.* The use of induced mutation combined with crossing in high quality rice breeding Proceeding of the 8th Workshop on Plant Mutation Breeding ...October 9-13, Hanoi, Vietnam (2000).
2. Bui Huy Thuy, Do Huu At, Dao Thanh Bang *et al.* Results of breeding and development of Rice Mutant Varieties DT10, DT11, DT13, Mutant Khang dan, D38 created by AGI in period from 1990 - 2007. Reports in Scientific Council of Ministry of Agriculture and Rural Development (MARD).
3. Mai Quang Vinh, Ngo Phuong Thinh *et al.* Results of breeding and development of Soybean Mutant Varieties DT83, DT84, DT90, DT95, DT96, DT99, DT2001, DT55(AK06), S31 created by AGI in period from 1990 - 2007. Reports in Scientific Council of MARD.
4. Mai Quang Vinh *et al.* Twenty year results on application of induced mutation in soybean (*Glycine max* (L.) Merr.) breeding at Agricultural Genetic Institute (AGI), Hanoi, Vietnam. Proceeding of the 8th workshop on plant mutation breeding-effective use of physical/chemical mutagens. October 9-13,2000, Hanoi,Vietnam.
5. Do Khac Thinh *et al.* Rice mutation improvement for short growth duration, hight yield and tolerance to adverse conditions in Mekong River Delta of Vietnam, reported at FAO/IAEA/RCA Stratigic Meeting on Nuclear Techniques for Rice Improvement in Asia, 4 - 7, November - 2004, Tokyo & Tsukuba, JAPAN.
6. Do Khac Thinh *et al.* Application of radiation mutation combined with hybridization to breed rice varieties having short duration, resistance to insects, diseases anf high quality for Southern Vietnam. Report in FNCA Workshop of Mutation Breeding, Korea - 2007 (in press)
7. Binh T. Nguyen *et al.* Characterizing resistance of soybean accessions to soybean rust (*Phakopsora pachyrhizi*). National soybean Rush Symposium. Nov.29 - Dec.1, 2006.St. Louis. Missouri, USA.

APPENDIX

Appendix 1. Mutant varieties released by Agricultural Genetics Institute (AGI) and other Organization up to 2007

Plant species	Mutation breeding cultivars		
	AGI	AGI +other	Other
Rice (<i>Oryza sativa</i> L.) 32 cultivars	DT10, DT11, DT33, DT17, DT50, CL8, CL9, DT21, DT22, Mutant Khang dan , DT38, CM1, CM6, MT4, MT6, DB250, DB2 (17)	A20, Mutant Tam thom (2)	VND95-20, VND95-19, VND99-3, VND95-26, VN4, TNDB, 6B, OM2118, NN22-98, TNDB100, THDB, ST3 Luc do (Red rice), ST3 Luc tim (Violet rice) (13)
Soybean (<i>Glycine max.</i>) 11 cultivars	DT84, DT90, DT96, DT99, DT94, DT95, DT83, DT2001, S-31 (9)	DT55 (AK06) (1)	M103 (1)
Maize (<i>Zea mays</i> L.)	DT6, DT8 (2)		
Groundnut (<i>Arachis hypogea</i> L.) 2 cultivars	DT332 (1)		B5000 (1)
Indian Jujube (<i>Ziziphus manritiana</i> L.) 2 cultivars			Dao tien, Ma hong (2)
Peppermint (<i>Mentha varvensis</i> L.) 1 cultivars	TN8 (1)		
Total: 50 cultivars	30	3	17

Appendix 2. Vietnam new mutant varieties and their cultural area (ha)

No	Variety	Organization	Origin	Mutagen	Certificate	Cultural area (ha)
Rice						
1	DT10	(AGI)	C4-63	200Gy + 0,025% NEU	NV, 1990	1,000,000 (1990 to present)
2	DT11	(AGI)	C4-63	20Kr + 0,025% NEU	NV, 1995	100,000(1995 to 2000)
3	A20	(AGI)	A8	0,015% NMU	NV, 1993	100,000 (1993 to present)
4	CM1	(AGI)	Chiem bau	200Gy	NV, 1999	1,000 ha/5 years
5	CM6	(AGI)	Chiem bau	200Gy	RV, 2000	1,000 ha/5 years
6	DT33	(AGI)	CR 203	200Gy	NV, 1994	200,000 ha (1994 to present)
8	DT38	(AGI)	KD 18	200Gy	RV,2007	500 ha/year
9	Khang dan mutant	(AGI)	KD 18	100-200Gy	NV, 2007	20,000 ha/year
10	Tam thom mutant	(AGI)	Tam thom	100-200Gy	NV, 2000	5,000ha/5 years
11	CL9	(AGI)	IR64/KD18	150Gy	NV, 2006	10,000 ha/2 years
12	CL8	(AGI)	DT20	150Gy	PV	5 000 ha
13	VND95-20	(IASS)	IR64	GI	NV,	900,000 ha/3 years
14	TNDB-100	(IASS)	Nang huong	GI	NV,	300,000 ha/3 years
15	VND 99-3	(IASS)	-	GI	NV,	45,000 ha, 60 bill. VND /3 years
16	OM 2118	(IASS)	-	200Gy	NV,	50,000 ha/3 years
17	ST3 red	CNT, HCM city	-	GI + H	PV	-
18	ST3 purple	CNT, HCM city	-	GI + H	PV	-
Maizes						
1	DT6	(AGI)	Mehico variety	GI + chemical	NV, 1990	50,000 ha (1990-2000)
2	DT8	(AGI)	DT6	GI + chemical	RV,1996	5,000 ha (1994-2004)
Soybeans						
1	DT84	(AGI)	DT80/ DH4	GI + H	NV, 1995	70,000 ha/year
2	DT90	(AGI)	K7002/Cuc	GI + H	NV, 2002	3,000 ha/year
3	DT96	(AGI)	DT84/DT90	GI + H	NV, 2004	5,000 ha/year
4	M103	(VASI)	DH4	EI	NV, 1990	1,000 ha/year
5	AK06 (DT55)	AGI, HAU, VASI	V74	GI	NV, 2000	1,800 ha/year
6	DT99	(AGI)	IS-011/Cuc	GI + H	RV,2003	11,000 ha/year
7	DT94	(AGI)	DT83/DT84	GI + H	RV	400 ha/year
8	DT95	(AGI)	AK04	GI	RV,1995	800 ha/year
9	DT83	(AGI)	coc chum variety	EI – 0.04%	RV,1990	50 ha/year
10	DT2001	(AGI)	DT84/DT83	GI + H	RV, 2007	500 ha/year
Peanut						
1	DT332	(AGI)	-	GI	RV, 1998	200 ha/year
Note: NV- National variety; RV- regional variety; PV- potential variety Gamma irradiation – GI; hybridization – H						

Induced Genetic Variability for Yield and Yield Components in Peanut (*Arachis hypogaea* L.)

H L Nadaf, S B Kaveri*, K Madhusudan & B N Motagi

Abstract

An experiment was conducted during 2005-07 to induce polygenic variability for yield and its components in peanut (*Arachis hypogaea* L.). Two cultivars of peanut, 'GPBD-4' and 'TPG-41' were treated with γ -radiation (200Gy & 300Gy) and ethyl methane sulphonate (EMS- 0.5 %). The mutagenized populations showed significantly higher variability in the M_2 generation. Mutant lines showing higher yield per plant than the respective parents and checks were isolated in M_2 and subsequent generation. The evaluation of 10 superior mutants isolated in M_4 over three successive generation yielded few mutants performing better over the parents and checks. In both the genotypes, superior mutants were isolated from 200Gy treatment, indicating effectiveness of the mutagen in obtaining the desired trait. Two of the mutant lines, G2-52 and TG2-30, gave significantly more pod yield (3,315 and 2,647 kg/ha respectively) than the parents and checks. One of the most interesting features of these mutant lines was the significant increase in hundred seed weight over the parent, contributing to higher yield. The mutant G2-82 recorded highest 100-seed weight of 40.28 g among GPBD-4 mutant population and T2-30 had 67.24 g as against parental value of (62.43 g). Mutants were found to be on par with respective parents for oil content, but had improved oil quality with their parental character of disease resistance/susceptible reaction. Magnitude of induced variation was found to depend upon the mutagen used, character under study and the genotypic background of the genotype. These promising mutant lines need to be further tested for their adaptability and stability. These can be further utilized in recombination breeding with other mutants and/or cultivars to derive distinct lines with improved agronomic traits.

Introduction

Peanut is an important food, feed and principal oilseed crop which is cultivated on a large scale throughout the world. Recently, peanut has been gaining importance as a food crop, due to its high content of digestible proteins, vitamins, minerals, and phytosterols, and to increased consumer preference after value addition. In India, 80% of the peanut produce is crushed for extraction of oil and accounts for 36.10% of the total oil production. Although India has achieved great success in cereal production, there is a large gap between the demand and supply of edible oils. It is estimated that more than 32 million tons of oilseeds are needed every year [1]. One possible way to increase oilseed production is to include efficient oilseed crops in existing cropping system and the second way is to develop high-yielding cultivars. Though the peanut crop has morphological, biochemical, and physiological variability, it has a narrow genetic base because of its monophyletic origin, and a lack of gene flow due to ploidy barrier and self-pollination. Consequently, the extent to which peanut cultivars may be improved through conventional breeding methods is limited. Hence, there is an urgent need to produce and identify new cultivars combining high level of disease resistance,

early maturity, besides increased yield and oil content in peanut. Mutation breeding supplements conventional plant breeding as a source of increasing variability and could confer specific improvement without significantly altering its acceptable phenotype [2]. The most popular mutagen used for creating genetic variability is gamma irradiation [3]. Besides gamma irradiation, chemical mutagens like ethyl-nitroso-urea, ethyl methane sulphonate and sodium azide are also used for mutation-assisted breeding. Genetic improvement of peanut through induced mutations alone or their use in recombination breeding has been in progress in our country since the late 1950s. Therefore, an attempt was made to induce polygenic variability in peanut and to isolate mutant genotypes with improved yields.

Materials and Methods

Material

Two Spanish Bunch genotypes viz., GPBD-4 and TPG-41 were used for mutagenic treatments.

Mutagen treatments

Seeds of peanut cultivars GPBD-4 and TPG-41 were treated with γ -radiation and ethyl methane sulphonate (EMS). Uniform size seeds of each cultivar were used for treatment. Treatments (500 seeds per treatment) consisted of two different doses of γ -radiation (200 and 300Gy) and EMS (0.5%). Untreated seed stock of the respective cultivars was used as a control. Seeds were irradiated with γ -radiation at Bhabha Atomic Research Center (BARC) Mumbai, India. EMS solution was prepared in 0.1 M phosphate buffer (pH = 7.0). Seeds were presoaked in distilled water for eight hours to allow uptake of EMS. Presoaked seeds were then treated with EMS for two hours at room temperature in cloth bags. Treated seeds were then rinsed in running tap water for four hours and sown in the field plots along with untreated control. The seeds were sown in a randomized complete block design in five replications with spacing of 30 cm between the rows and between plants. The recommended package of practice for the crop was followed. The M_1 plants were harvested on a single plant basis. In M_2 , 90 mutant lines/progenies, yielding more than respective controls viz., GBD-4 and TPG-41 for kernel yield per plant were selected and further evaluated in replicated trial to assess the performance over different generations. Segregating mutant lines based on visual observations and low performing were discarded in the initial stages of evaluation and progenies were advanced on the basis of superiority of their yield performance over the respective controls, finally ending up with 10 superior mutant lines in M_4 generation. The selected 10 mutant progenies were evaluated during the summer of 2005 (M_3) and kharif 2006 and kharif 2007 (M_6 - M_7) in a replicated trial to assess their performance and identify high-yielding mutants. The 10 mutants, untreated controls (parents) and two checks were grown in randomized complete block design with three replications in a plot of 4.0 m x 2.4 m with spacing of 30 cm x 10 cm over three successive generations. From each entry, 10 plants were randomly selected for recording observations

National Seed Project, Seed Unit, University of Agricultural Sciences, Dharwad, Karnataka, India

* Corresponding author. E-mail: sosuasd@yahoo.com; kaveri_pnut@rediffmail.com

on important yield attributing characters, plant height (cm), number of branches, number of pods, pod yield (g), kernel yield (g), pod yield/plot, shelling percent and sound mature kernel percentage.

Fatty acid analysis

Fatty acid analysis of superior mutants for yield selected over three generations was accomplished in M_7 following the extraction and esterification method [4]. The oil content of the selected mutants based on fatty acid profile was determined by the nuclear magnetic resonance (NMR) technique [5]. The modified nine-point scale for rust and late leaf spot [6] was used for assessing genotypes for the reaction to late leaf spot and rust diseases.

Gas chromatography analysis

A gas chromatograph, model GC-2010 equipped with automatic sample injector AOC-20i, flame ionization detector (Shimadzu, Kyoto, Japan) and fitted with a narrow bore capillary column; Rtx-wax (film thickness-0.25 μ m; I. D.-0.25 mm; length-30 m) was used to separate methyl esters. The initial column temperature was set at 170°C and held for three minutes, then programmed at an increase of 10 C per minute to a final temperature of 230°C, at which it was held for 1 minute. Injector and detector temperatures were both set at 250°C. The flow rates for nitrogen (carrier gas), hydrogen and air were 45, 40 and 400 ml per minute respectively. The fatty acid methyl esters were compared by a comparison of retention time to a standard methyl ester fatty acid mixture (Sigma, Aldrich). Concentration of each fatty acid were recorded by normalization of peak areas and reported as percent of particular fatty acid.

Statistical analysis

In each generation the parent and mutants were compared for yield and yield components by Student 't' test using MstatC software. The data of 10 mutant lines evaluated in M_5 , M_6 and M_7 were subjected to pooled analysis using SPAR1. Two-way analysis of variance was computed to ascertain differences in the treatments and genotypes and their interaction. Significant differences between and within treatments means were determined using critical difference (CD) values. The oil quality parameters viz., O/L ratio, unsaturated to saturated ratio (U/S) and iodine value (IV) were computed as follows.

$$\text{O/L ratio} = \% \text{ oleic (C18:1)} / \% \text{ linoleic (C18:2)}$$

$$\text{U/S ratio} = \% (\text{oleic} + \text{linoleic} + \text{ecosenoic}) / \% (\text{palmitic} + \text{stearic} + \text{arachidic} + \text{behenic} + \text{lignoceric}).$$

$$\text{Iodine value} = (\% \text{ oleic} \times 0.8601) + (\% \text{ linoleic} \times 1.7321) + (\% \text{ ecosenoic} \times 0.7854) [7]$$

Results and Discussion

As yield increment has been the prime objective in most of the plant breeding programmes, mutation breeding had played a key role in achieving the goal. Induced mutants or their utilization in recombination breeding with other mutants and/or cultivars evolved several distinct Trombay groundnut (TG) lines, which had improved agronomic traits.

Performance of the entries

Results obtained from the analysis of variance are shown in **Table 1**. There were significant differences among entries for pod yield, shelling

Table 1. Mean squares in the analysis of variance for characteristics measured on 17 peanut mutant lines evaluated over three seasons.

Source of variation	d.f.	Mean squares					
		Pod yield (kg/ha)	Shelling %	100-seed weight (g)	Sound mature kernels %	Pod no/plant	Oil content %
Factor A(generation)	2	546.30**	504.10**	1294.40**	27.93**	903.0**	14.25**
Factor B (genotype)	16	133.56**	63.40**	989.70**	16.60**	235.30**	8.20**
Interaction	32	12.38**	20.09**	30.50**	14.09**	29.10**	1.59**
Error	96	5.98	8.80	5.23	1.80	3.64	0.55

** significance at p<0.01

Table 2. Mutants with enhanced yield and component traits in peanut over three generations

Mutants	Pod yield (kg/ha)	Shelling %	100 SW (g)	SMK %	NP/plant	Oil content %	% yield increase over parent	O/L ratio	LLS	Rust
G2-52 ^a	3315	69.32	38.71	86.90	33.28	47.90	25.32	2.14	2.0	2.0
G2-49	3120	68.82	36.11	86.67	30.71	48.00	17.91	1.71	2.0	2.0
G2-58	3100	67.20	39.51	88.33	33.08	47.21	17.20	1.88	2.0	2.0
G2-29	3026	70.63	38.91	88.00	30.70	47.62	14.36	1.59	2.0	2.0
G2-82	2930	70.77	40.28	85.67	32.02	47.68	10.70	1.67	2.0	2.0
TG2-30	2647	65.70	67.24	86.00	22.76	45.88	17.64	2.67	8.0	7.0
Parents										
GPBD-4	2646	67.43	35.00	86.44	34.10	47.32		1.65	2.0	2.0
TPG-41	2250	65.57	62.43	83.00	20.60	45.20		2.56	8.0	8.0
Checks										
TMV-2	2298	64.56	34.18	85.67	24.25	45.78		1.08	8.0	7
JL-24	2310	63.83	48.24	85.56	23.03	45.86		0.98	8.0	8.0
CD (1%)	4.24	5.17	3.98	2.32	3.32	1.30				
CD (5%)	3.20	3.90	3.01	1.76	2.51	0.97				

^a First and second alphabet indicates the genotype and mutagen treatment respectively (Ex. G2-52: GPBD-4, 200 Gy, 52 progeny)

percent, 100-seed weight, number of pods/plant and oil content ($p < 0.01$) averaged over the three generations. The traits also showed significant generation and interaction effects. However the proportion of variation due to generation is more followed by genotypic variation.

Mean values of the top six out of 10 mutants for yield and yield components averaged over three generations are presented in **Table 2**. The mutants showed significant differences for most of the traits studied. All the mutants derived from GPBD-4 were significantly higher yielding than the parent and checks and some of the mutants revealed significant differences for shelling percent (S%), pod number/plant and sound mature kernel percent (SMK%). On average over three generations, the mutant line G2-52 recorded the highest yield (3315 kg/ha). This was followed by G2-49 (3120 kg/ha), G2-58 (3100 kg/ha) and G2-29 (3026 kg/ha). Mutant line T2-30 derived from TPG-41 exhibited higher yield (2647 kg/ha) compared to its parent (2250 kg/ha) and checks (2304 kg/ha). Shelling percent showed significant differences ($p < 0.01$), where G2-82 gave the highest result (70.77 %), followed by G2-29 (70.63 %). Mutants recorded significant differences for 100-seed weight over the respective parents and revealed non-significant differences compared to checks. Among the GPBD-4 mutants, G2-82 recorded highest 100-seed weight of 40.28 g and T2-30 had 67.24 g. Mutant G2-52 had the maximum number of pods per plant (33.28) and it was closely followed by G2-58 (33.08). Two of the mutants of GPBD-4 viz., G2-58 (88.33%) and G2-29 (88.0%) recorded significant differences for SMK%. The mutants were superior for oil content compared to checks but on par with the parental values. Percent increase for pod yield over the respective parents clearly indicates the superiority of the mutants lines identified over three generations, ranging from 10.70% (G2-82) to 25.32% (G2-52). The superior mutants identified in both generations were from 200Gy treatment, indicating the effectiveness of mutagen in obtaining the desired traits.

From these varied performances of mutants, it can be inferred that the mutants and cultivars evaluated in this study represented a wide range of performance. This is supported by the fact that the two genotypes differed in their response to mutagenic treatment. One of the most interesting features of these mutant lines was the significant increase in 100-seed weight over the parental value contributing to higher yield. In peanut, large seeds have consumer and market preference, particularly for confectionery and value addition, in turn fetching premium prices in domestic and international markets. High-yielding, large-seeded varieties with earliness would fit into a diverse cropping pattern. Several

large-seeded cultivars have been released [8, 9]. High-yielding mutants of peanut in different generations have been reported by earlier scientists [10, 11].

The mutants were evaluated for fatty acid profile and disease resistance in the M_7 generation. Interestingly they had high O/L ratio compared to parents and checks and the genetic background of the parents for disease resistance was found unaltered. Based on yield and yield contributing parameters, the selected mutants were found to be significantly superior for pod yield accompanied with significant improvement in O/L ratio and parental character of disease resistance/susceptible reaction. These promising mutant lines need to be further tested for their adaptability and stability. These can be further utilized in recombination breeding with other mutants and/or cultivars to derive distinct lines with improved agronomic traits.

BIBLIOGRAPHY

1. Sidhu, M. S. *et al.* Evaluation of summer groundnut based cropping systems for productivity and economic returns in India. *International Arachis Newsletter*, **17**, 54-55 (1997).
2. Ojomo *et al.*, Studies in induced mutation in cowpea, 5. The variation in protein content following ionizing radiation. *Nig. J. Applied Science* **21**, 61-64 (1979).
3. Reddy, P. S. *et al.* Creation of genetic variability by recourse to irradiation in groundnut (*Arachis hypogaea* L.). *Oleagineux*, **32** 59-63 (1977).
4. Knauff, D. A. *et al.* Further studies on the inheritance of fatty acid composition in peanut. *Peanut Science* **20**, 74-76 (1993).
5. Jambunathan, R. *et al.* Analysis of oil content of groundnuts by nuclear magnetic resonance spectrophotometry. *Journal Science Food Agriculture*, **36** (1985) 162-166.
6. Subbarao, P. V. *et al.* A modified nine point disease scale for assessment of rust and late leaf spot of groundnut. In: Second International congress of French Phytopathological Society, 28-30 November (1990).
7. Cocks, L. V., Rede, V. C. In: Laboratory Handbook for oil and fat analysis. Academic Press New York, (1966).
8. Patil, S. H., Mouli, C. Genetics of a dwarf mutant in groundnut. *Theoretical and Applied Genetics* **46**, 395-400 (1975).
9. Mouli, C. *et al.* A large seeded Spanish groundnut. *Groundnut News* **2**, 3 (1990).
10. Ramanathan, T., Mutational studies in groundnut. Ph. D. Thesis, TamilNadu Agri. Univ., Coimbatore, India (1979).
11. Prasad, M. V. R. *et al.* Induced mutants of peanut (*Arachis hypogaea* L.) for canopy and pod bearing characters. *Indian Journal of Genetics and Plant Breeding* **44**, 25-34 (1984).

Selection for Resistance to Yellow Vein Mosaic Virus Disease of Okra by Induced Mutation

V Phadvibulya^{1*}, K Boonsirichai¹, A Adthlungrong² & W Srithongchai³

Abstract

Yellow vein mosaic virus disease (YVMD) caused by a begomovirus is the most serious factor affecting okra (*Abelmoschus esculentus*) production for both exporting and domestic consumption in Thailand. Seeds of two okra varieties, Annie and Okura, were irradiated with Gamma-rays at doses of 400 and 600Gy. Screening of YVMD resistant plants was conducted for M₃ and M₄ plants under field conditions in Petchaburi and Phichit provinces, and greenhouse conditions using whitefly transmission in Bangkok. One M₄ plant of Okura (B-21) irradiated at 400Gy was found to be highly resistant, but none of Annie. M₅ plants of B-21 were screened further for YVMD resistance under both greenhouse and field conditions. Ten resistant lines obtained by screening for YVMD resistance up to the M₇ generation were selected for yield trial observations at Phichit Horticultural Research Center (PHRC) and Chiangmai Horticultural Research Station (CHRS), both located in the northern Thailand. Three of the mutant lines were further tested at Kanchanaburi Horticultural Research Center (KHRC) in Kanchanaburi province, an okra growing area in the west of central Thailand where YVMD was seriously widespread. At the KHRC, all tested mutant lines showed resistance up to a month, when the susceptible check variety already showed symptoms of the disease. However, only a small portion of the plants of the mutant lines appeared to be resistant throughout the whole growth duration; others eventually exhibited the yellow vein symptom. Plants were further screened in two growers' fields. Growers were satisfied with the plant stature and fruit shape of the mutants and their delayed disease development, and further screening is underway to select uniformly YVMD resistant lines for okra production in Kanchanaburi.

Introduction

Okra breeding programmes for the yellow vein mosaic virus disease (YVMD) in Thailand involve selection breeding [1], cross breeding [2] and mutation breeding [3]. Our programme focuses on mutation breeding and utilizes whitefly transmission of YVMD under greenhouse conditions, as well as field screenings at Phichit Horticultural Research Center (PHRC) and Chiangmai Horticultural Research Station (CHRS) to identify resistant individuals. Later on, some of the resistant lines obtained from these locations were field-tested at Kanchanaburi Horticultural Research Center (KHRC). It was observed that YVMD manifested itself more aggressively on the mutants tested there than at PHRC and CHRS. Nonetheless, mutant lines from our breeding programme exhibited a higher percentage of resistant individuals than okra lines obtained via other breeding techniques being tested at the same time. As a result, further screenings of the mutants were conducted in the fields of commercial okra growers in Kanchanaburi.

Materials And Methods

Seeds of two okra varieties, Annie and Okura, were irradiated at doses of 400 and 600Gy and planted with non-irradiated ones at Huaysai King's Project, Petchaburi province. M₂ seeds from plants with good phenotype were planted. M₃ seeds were collected from selfed flowers of healthy plants and grown at PHRC and Huaysai King's Project for YVMD screening under field conditions. M₃ plants without the disease symptoms were selected to collect M₄ seeds (each plant as a line). About 40 M₄ seeds of each line were planted and screened for YVMD resistance by using whitefly transmission under greenhouse conditions at Crop Protection Research and Development Office. Plants without disease symptoms were transplanted to the field at PHRC, and M₅ seeds were collected. The same selection techniques as in the M₄ generation were repeated from the M₅ up to the M₇ generation. The resistant lines were selected for yield trials and resistance screening at CHRC and PHRC. Three of them were tested for YVMD resistance at the Kanchanaburi Horticultural Research Center (KHRC) in Kanchanaburi province, west of central Thailand, where YVMD was seriously widespread. Seeds of resistant individuals were collected and planted in the fields of two okra growers in Kanchanaburi for further screening in order to obtain uniform okra lines with good fruit quality as well as YVMD resistance.

Results

Development of YVMD resistant mutant lines

A single YVMD resistant mutant plant, B-21, was identified in the M₄ generation from 400Gy gamma-irradiation of Okura variety only. Resistant individuals that were derived from this plant were further screened up to the M₇ generation. Ten resistant lines were selected for yield trials and resistance screening at CHRS and PHRC (Fig. 1 and Table 1). Spines were observed on the skin of the fruits in some of the lines. Seven lines exhibiting uniformed resistance to YVMD and spineless pods were later selected.



Figure 1 YVMD symptoms in a susceptible okra plant (Left panel). Resistant B-21 mutant plants are shown in the right panel with the susceptible Pichit 03 in the middle. Location: Phichit Horticultural Research Center.

Performance of YVMD resistant mutants in Kanchanaburi

Three of the B-21-derived, spineless mutant lines, including B4606, B4609 and B4610, were tested at the KHRC and at two okra grower's fields. It was observed that the disease symptoms were more severe in Kanchanaburi than in Phichit. All tested mutant lines showed resistance

¹ Research and Development Division, Thailand Institute of Nuclear Technology (Public Organization), Nakornnayok, Thailand

² Horticultural Research Institute, Department of Agriculture, Bangkok, Thailand

³ Crop Protection Research and Development Office, Department of Agriculture, Bangkok, Thailand

* Corresponding author. E-mail: valailak@tint.or.th

to YVMD up to a month, when the susceptible check variety already showed symptoms of the disease. However, only a small portion of the plants of mutant lines appeared to be resistant in the whole growth duration, others eventually exhibited the yellow vein symptom. (Fig. 2, Table 2).

Table 1. Yield trial of 10 B-21-derived mutant lines at Pichit Horticultural Research Center (PHRC) and Chiangmai Horticultural Research Station (CHRS).

Mutant line	PHRC		CHRS	
	Yield ^a (kg/rai) ^b	% resistant plants	Yield (kg/rai)	% resistant plants
B4601	8167	99.2	10140	75.2
B4602	6169	94.8	8671	66.3
B4603	8309	81.0	9090	62.8
B4604	9716	94.1	10127	62.8
B4605	7746	77.1	9791	55.9
B4606	7355	65.6	8192	48.2
B4607	7997	95.6	9488	60.7
B4608	7318	94.0	9493	55.6
B4609	9224	86.7	10896	58.3
B4610	6379	55.4	6743	29.9
Resistant check Hit 9701	5966	100.0	5329	72.8
Susceptible check Pichit 03	454	0.0	2849	0.0

^a Measured as fresh weight of fruits per growing area
^b 1 rai = 6.25 ha



Figure 2 Performance of three mutant lines (B4606, B4609 and B4610) and one YVMD susceptible check variety (Pichit 03) in Kancharaburi field trial. YVMD susceptible plants showed yellow leaves, while resistant individuals (marked with a red tie) were with normal leaves (two bottom right panels).

Breeding YVMD resistant lines for Kancharaburi

Progenies of the plants without YVMD are being screened further in order to obtain uniform YVMD resistant okra lines for production in Kancharaburi. Attention is also paid to the selection of other agronomic and quality related traits. Compared to a commercial variety grown by both growers, these mutant lines yielded plumper, fleshier, green fresh pods, which satisfied the growers (Fig. 3).

Table 2. Segregation of YVMD resistance in mutant lines in different experiments in Kancharaburi, Thailand

Material	KHRC			Grower's field 1			Grower's field 2		
	Dis-eased	Not dis-eased	Total	Diseased	Not diseased	Total	Diseased	Not dis-eased	Total
B4606	13	27	40	220	22	242	253	35	288
B4609	25	15	40	245	19	264	433	39	472
B4610	26	14	40	325	40	365	422	27	449
Pichit 03	40	0	40	296	0	296	113	0	113



Figure 3 Fruit characteristics of three mutant lines (B4606, B4609 and B4610), compared to that of a commercial variety. All four plant lines were grown in a grower's field in Kancharaburi.

Discussion

Gamma radiation was successfully applied to induce a mutation that conferred YVMD resistance in the okra variety 'Okura'. However, the resistant mutant lines that were obtained through selection at PHRC and CHRS failed to exhibit uniform resistance to YVMD when grown at KHRC and in okra growers' fields in Kancharaburi, the major okra growing area. The disease symptoms of the susceptible Pichit 03 appeared more severe in Kancharaburi than in Pichit and Chiangmai provinces. Both Pichit and Chiangmai are located in northern Thailand, while Kancharaburi is located to the west of central Thailand. Therefore, it was possible that the strain of YVMV in Kancharaburi differed from that found in Pichit and Chiangmai. It would be interesting to investigate the differences of their viral DNA sequence.

Although the symptoms were severe, the majority of the mutant individuals yielded plump, green fruit pods and developed YVMD symptoms later than the susceptible Pichit 03, allowing for additional yield collections in Kancharaburi. The growers were satisfied with the fruit characteristics of these mutant lines and took part in the selection for YVMD resistant individuals.

Since the molecular basis of YVMD resistance in general is not yet understood, the mutant lines would provide excellent materials for further study on the genetics of YVMD resistance in okra and to identify DNA markers for the YVMD resistance, and eventually to determine the nature of the obtained mutation in the future.

ACKNOWLEDGEMENTS

This work was partly funded by research contract no. 12824 from the International Atomic Energy Agency.

BIBLIOGRAPHY

1. Adthlungong, A., Kittipakorn, K., Cherddilok, R., Wattanachai, C. 2000. Identification of the yellow vein mosaic disease resistant okra varieties. *Annual Report 2000*. Pichit Horticultural Research Center. Department of Agriculture, Thailand. In Thai.
2. Adthlungong, A., Choodee, K., Tayamanon, P., 2008. Comparison of okra lines obtained from hybridization between the Japanese and the Indian okra. In *Proceedings of the Research and Development on Plants and Agricultural Technology 2007*. Department of Agriculture, Ministry of Agriculture and Cooperatives, Thailand. p.104.
3. Phadvivulya, V., Puripunyanich, P., Adthlungong, A., Kittipakorn, K., Lavapaurya, T. 2004. Induced mutation breeding for resistance to yellow vein mosaic virus in okra. In *Genetic improvement of under-utilized and neglected crops in low income food deficit countries through irradiation and related techniques*. International Atomic Energy Agency, Vienna. p.155-173.

Genetics of the Radiation-Induced Yellow Vein Mosaic Disease Resistance Mutation in Okra

K Boonsirichai^{1*}, V Phadvibulya¹, A Adthlungrong², W Srithongchai³, V Puripunyanich¹ & S Chookaew¹

Abstract

Yellow vein mosaic disease (YVMD) is one of the major diseases affecting okra production in Thailand. YVMD-resistant B4610 mutant was generated through gamma irradiation of the Okura variety of okra. In an attempt to develop a DNA marker for YVMD-resistance, a BC₁F₁ and an F₂ mapping population were generated from the cross between B4610 and Pichit 03, a YVMD-susceptible variety. The populations were naturally inoculated with YVMD virus in the field at Pichit Horticultural Research Center, Pichit province, where the disease is widespread. Analysis of F₁ and F₂ progeny revealed the semi-dominant nature of the resistance which appeared to be caused by a single-locus mutation. MFLP fingerprintings of the F₂ and the BC₁F₁ populations revealed a DNA fragment that is potentially linked to the mutation. In addition to the visual assessment of YVMD, a PCR method was developed for the assay of the presence of YVMD virus in leaf tissues. Sequencing of the amplified DNA fragments confirmed the presence of okra YVMD virus in the infected leaf tissues in susceptible plants.

Introduction

The yellow vein mosaic disease (YVMD) can cause yellowness in leaf veins, shoots and fruits, affecting plant growth and yield. Resistant germplasm originally isolated in India produces long and skinny pods, in contrast to the plump but shorter pods of Japanese-derived varieties, such as Okura, grown in Thailand for export. Gamma radiation has been used to induce YVMD resistance mutation in the Okura variety of okra. B-21 mutant was identified in M₄ generation as a resistant individual [1]. The line B4610, derived from B-21, showing uniform resistance, was later identified in subsequent generations.

YVMD is caused by a geminivirus and can be transmitted through white fly *Besimia tabaci* Gen. and also through cuttings and grafts. However, it cannot be transmitted through seeds. The mechanism of YVMD resistance in B-21-derived plants is not understood. In order to identify genes responsible for YVMD resistance in the line B4610, we have generated mapping population and initially identified linked DNA fragments as a basis for future identification of the nature of the mutation.

Materials And Methods

YVMD resistant mutant seeds and growing conditions

YVMD resistant mutant seeds belonged to the line B4610 of the M₈ and M₉ generations derived from B-21 mutant. Crosses between the mutant and Okura or between the mutant and Pichit 03 were conducted and their progeny planted in the field at the Pichit Horticultural Research Center, Pichit province, where YVMD had been widespread.

Greenhouse inoculations using the white fly carrier were conducted on okra seedlings at the nursery belonging to the Crop Protection Research and Development Office, Department of Agriculture, Bangkok. YVMV-carrying white flies were captured from Pichit province for inoculations of F₁, F₂, BC₁F₁ individuals. Inoculations of Pichit03 and B4610 for the development of a PCR method for YVMV detection were carried out with YVMV-carrying white flies from Pichit and Kanchanburi provinces.

DNA extraction

DNA was extracted from leaf tissues using a method modified from Dellaporta, *et al.* [2] and Boonsirichai, *et al.* [3]. Briefly, frozen leaf tissues were ground in 100mM Tris-HCl, pH 8.0, 50mM EDTA, 500mM NaCl, 0.1% 2-mercaptoethanol. Twenty percent SDS was added and the mixture was incubated at 65°C. Proteins were precipitated out by the addition of 5M potassium acetate. The supernatant was extracted with chloroform, and the DNA was precipitated twice with isopropanol.

Determination of YVMD susceptibility

YVMD susceptibility was determined by visual inspection in the field and by PCR amplification of the viral DNA. Susceptible plants showed yellowing of leaf veins and yellow spots on leaves. The disease was observable within two to four weeks after planting in susceptible Pichit 03. Plants were inspected for symptoms every two weeks in the field.

DNA fingerprinting

MFLP fingerprinting was conducted as described by Yang, *et al.* [4]. The sequences of microsatellite-anchored primers are shown in Table 1. Selective nucleotides of *Mse*I adaptor primer were CCG, CGT, CGG, CCT, CAA, CCA, CAG, CAC, CAT and CGA. MFLP products were separated on a 4.5% acrylamide, 7M urea gel [5] and stained with silver nitrate [6].

Table 1. Sequence of microsatellite-anchored primers for MFLP fingerprints.

Microsatellite-anchored primer	Sequence (5' to 3')
MF42	GTC TAA CAA CAA CAA CAA C
MF43	CCT CAA GAA GAA GAA GAA G
MF51	GGG AAC AACAAC AAC
MF78	GGC AAG AAG AAG AAG A
MF128	DVD TCT CTC TCT CTC TC*
MF201	CCC ATT GTT GTT GTT G

* D = A+G+T; V = A+G+C

Development of a PCR method for YVMV detection

Four PCR primers were designed based on synonymous nucleotides of the okra yellow mosaic viral AV1 coat protein gene from the Pakistani and Mexican isolates (GENBANK no. AJ002450 and DQ308546). The primer sequences were AV1F1 5'-CTC GTA ATT ATG TCG AAG

¹ Research and Development Division, Thailand Institute of Nuclear Technology (Public Organization), Bangkok, Thailand

² Horticultural Research Institute, Department of Agriculture, Bangkok, Thailand

³ Crop Protection Research and Development Office, Department of Agriculture, Bangkok, Thailand

* Corresponding author. E-mail: kboonsir@yahoo.com

CGA-3', AV1F2 5'-AAA CAG GCC TAT GAA CAG GAA A-3', AV1R1 5'-CTT AAG AGT AGC ATA CAC TGG-3' and AV1R2 5'-ACA AGG AAA AAC ATC ACC GAA T-3'. Thermal cycle conditions were 30 cycles of 30 sec at 95°C, 30 sec at 50°C and 1 min at 70°C. PCR products were analyzed on 1% agarose gels and stained with ethidium bromide.

Results

Genetics of YVMD resistance

F_1 , F_2 and BC_1F_1 seeds were generated from the cross between B4610, a B-21-derived YVMD resistant line, and Pichit 03, a susceptible variety. Upon a natural inoculation with YVMV in the field, F_1 individuals exhibited prolonged resistance comparing to Pichit 03 but eventually developed YVMD symptoms. Therefore, the YVMD resistance mutation is semi-dominant. The segregation of resistance: susceptible individuals for F_2 and BC_1F_1 populations fit the expected ratios of 3:1 and 1:1, respectively, for a single dominant resistance gene (Table 2). Thus, the mutation could be treated as a dominant mutation when disease susceptibility was assessed at two to two-and-a-half months.

Table 2. Segregation of YVMD resistance among okra populations

Okra population	Total number of plants	Percentage of plants with YVMD [†]	p -value*
Pichit 03	213	91.5	-
B4610	206	0	-
B4610 x Pichit 03; F_1	207	2.4	-
Pichit 03 x B4610; F_1	209	5.3	-
B4610 x Pichit 03; F_2	405	24.0	0.63
Pichit 03 x B4610; F_2	416	24.8	0.91
Pichit 03 x (B4610 x Pichit 03)	413	50.6	0.81
Pichit 03 x (Pichit 03 x B4610)	408	49.5	0.84

* Based on a single-locus mutation hypothesis.

[†] YVMD was assessed at 2.5 months.

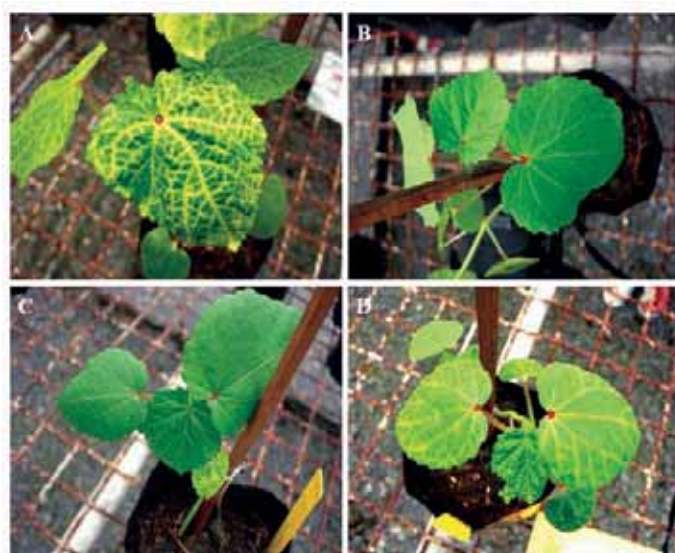

Figure 1 Okra seedlings individually inoculated with YVMV in the greenhouse. (A) Pichit 03. (B) B4610. (C) A resistant F_2 segregant. (D) A susceptible F_2 segregant.

In addition, 19 BC_1 individuals of the cross Okura x B4610 and 11 F_1 individuals of the cross Pichit 03 x B4610 were individually inoculated with the Pichit isolate of YVMV in the greenhouse in order to

confirm the dominant nature of the mutation. All BC_1 and F_1 individuals appeared resistant at six weeks after inoculation, while all of the 22 Pichit 03 individuals tested had developed YVMD symptoms (data not shown). Forty-four F_2 individuals from the cross Pichit 03 x B4610 were also tested. Only 10 of them were found with the disease ($p = 0.67$ for a single locus dominant mutation) (Fig. 1). Thus, the data also supported the conclusion that the mutation appeared dominant and resulted from a single locus mutation.

Cosegregation analysis

MFLP fingerprints were performed on 52 YVMD resistant individuals and 52 susceptible individuals from the cross Pichit03 x (Pichit03 x B4610). Sixty primer combinations, consisting of six microsatellite-anchor primers and 10 selective *MseI*-adaptor primers, were analyzed. A DNA fragment that showed potential linkage to YVMD resistance was identified with MF43 microsatellite-anchor primer and the *MseI*-CAG selective primer (Fig. 2). The fragment exhibited the recombination frequency of 0.192 with YVMD resistance.

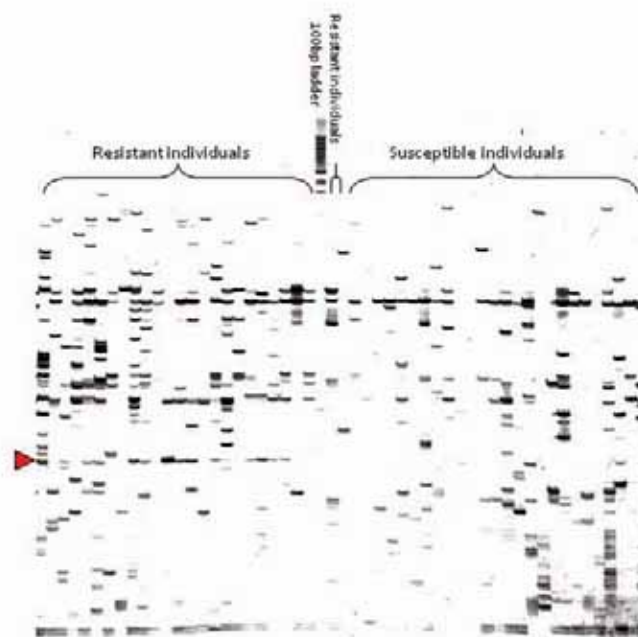

Figure 2 DNA fragment that showed linkage to YVMD resistance (red arrow), obtained from MFLP fingerprinting with primers MF43 (AAG repeats) and *MseI*-CAG.

Development of a PCR method for YVMV detection

Four viral AV1-specific primers were tested against naturally inoculated susceptible Pichit 03 and resistant B4610 individuals grown at the Pichit Horticultural Research Center. Two primer combinations, AV1F1+AV1R1 and AV1F2+AV1R1, showed a single positive DNA band of the expected sizes from the inoculated Pichit 03 sample, while no PCR products were observed from the two resistant B4610 samples (Fig. 3A). Sequencing of the PCR product from the latter primer combination showed 88.5% sequence identity at the DNA level between the product itself and the YVMV AV1 sequence from the Madurai and the Pakistani viral isolates, indicating that the correct locus had been amplified (Fig. 4). Further tests showed that both primer combinations tested positive against YVMV isolates from Pichit province in the northern part of Thailand as well as from Kanchanaburi province in the western part of Thailand (data from one of the primer combinations is shown in Fig. 3B). Thus, they can be used to detect YVMV infection from samples grown in multiple regions of Thailand.

Discussion

The mechanism of YVMD resistance in okra is not yet understood. We showed that the YVMD resistance mutation, which was obtained through gamma-radiation induction, was semi-dominant. This is in contrast to most radiation-induced mutations, which are recessive in nature and result from loss of gene functions. However, in this study, we cannot yet conclude whether the YVMD mutation involves a loss or a gain of gene functions. Dosage effects might be involved as the heterozygotes showed prolonged resistance but eventually developed the disease.

In other crop plants, genes conferring resistance to mosaic viruses have started to be mapped. In soybean, at least three loci were shown to be involved in the resistance to the soybean mosaic virus [7]. AFLP technique was used to successfully identify linked markers, even in a population showing relatively low genetic polymorphisms. In this report, both AFLP and MFLP fingerprinting techniques were utilized because MFLP primers are anchored to microsatellite loci and therefore should reveal more polymorphisms than AFLP. A linked DNA fragment was successfully identified through MFLP fingerprinting. Nonetheless, additional linked markers are needed in order to identify the gene responsible for the resistance. Bulk segregation analysis and extensive AFLP and MFLP fingerprinting should prove to be an effective strategy for this purpose.

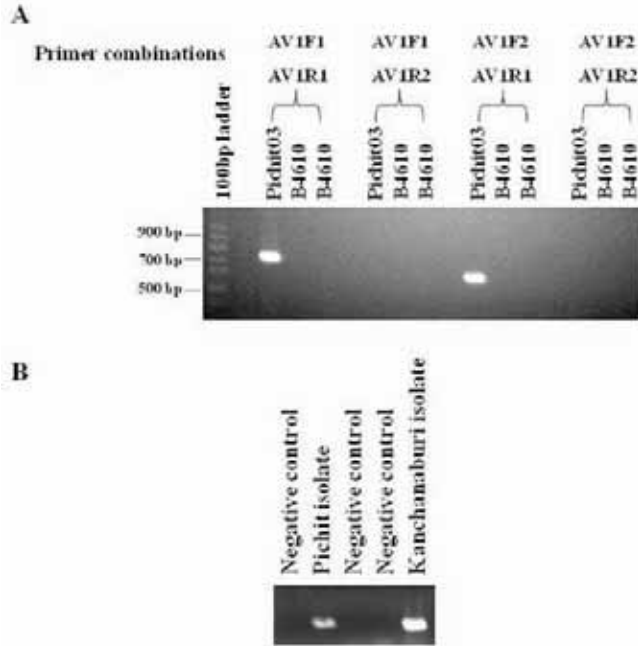

Figure 3 Detection of YVMV by a PCR method. (A) Two primer combinations, AV1F1+AV1R1 and AV1F2+AV1R1, successfully amplified the viral AV1 gene fragment. (B) Primer combination AV1F2+AV1R1 could detect Pichit and Kanchanaburi isolates of YVMV.

YVMD is caused by a Gemini virus. Identification of the disease is currently based on visual inspection and ELISA method, which is cumbersome. We have developed a PCR method for detection of YVMV in leaf tissues, based on the AV1 gene sequence. The assay could identify the infection relatively easily and could detect at least two local isolates of the virus.



Figure 4 Sequence alignment of okra YVMV isolates from Madurai (India), Pakistan and Pichit province. Asterisks indicate sequence identity among the three isolates.

ACKNOWLEDGEMENTS

This work is funded by Thailand Institute of Nuclear Technology and International Atomic Energy Agency research contract no.12824. We thank Mr. Wanchai Dhammavanich for suggestions on the manuscript.

BIBLIOGRAPHY

1. Phadivibulya, V., Puripanyavanich, V., Kittipakorn, K., and Adthalongrong, A. 2001. Induce mutation for resistance to yellow vein disease in okra. in The 8th Nuclear Science and Technology Conference. Radiation and Life. Kasetsart University, Bangkok, Thailand. p.53-62.
2. Dellaporta, S.L., Wood, J. and Hicks, J.B. A plant DNA mini-preparation version II. *Plant Mol. Biol. Reprtr.* **1**, 19-21 (1983).
3. Boonsirichai, K., Puripanyavanich, V., Phadivibulya, V., Adthalongrong, A. and Srithongchai, W. Comparison between the DNA Fingerprints Obtained from the Yellow Vein Mosaic Disease Tolerant Okra Mutants and Their Parental Variety. in The Proceedings of 44th Kasetsart University Annual Conference. Book 1, p. 547-555 (2006).
4. Yang, H., Sweetingham, W., Cowling, W.A., Smith, P.M.C. DNA fingerprinting based on microsatellite-anchored fragment length polymorphisms, and isolation of sequence-specific PCR markers in lupin (*Lupinus angustifolius* L.). *Molecular Breeding* **7**, 203-209 (2001).
5. Vos, P., Hogers, R., Bleeker, M., Reijans, M., van de Lee, T., Hornes, M., Frijters, A., Pot, J., Peleman, J., Kuiper, M., Zabeau, M. AFLP: A new technique for DNA fingerprinting. *Nucleic Acids Research* **23**, 4407-4414 (1995).
6. Promega Corporation. Silver Sequence™ DNA Sequencing System. Technical Manual No. 023. available at <http://www.promega.com> (2000).
7. Hayes, A.J., Ma, G., Buss, G.R., Maroof, M.A. Molecular marker mapping of RSV4, a gene conferring resistance to all known strains of soybean mosaic virus. *Crop Sci.* **40**, 1434-1437 (2000).

Current Status of Mungbean and the Use of Mutation Breeding in Thailand

S Ngampongsai^{1*}, A Watanasit¹, S Srisombun², P Srinives³ & A Masari¹

Abstract

Seeds of mungbean varieties Khampang Saen 1 (KPS1) and Chai Nat 36 (CN36) were irradiated with a dose of 500Gy Gamma-rays and treated with 1% ethyl methane sulphonate. The objectives of this experiment were seed yield improvement and powdery mildew resistance. A number of mutant lines were selected from M₂ onwards. Three promising mutants, M4-2, M5-1 and M5-5, gave 8-11% and 2-5% higher mean yield than those of KPS1 and CN36, but showed similar disease infection to their original parents tested during 1997-2006. The objective of the second experiment was to improve mungbean variety tolerance to beanfly, a key pest of mungbean. Seeds of var Khampang Saen 2 (KPS2) were irradiated with 600Gy Gamma-rays. A mutant line was selected and subsequently officially released as Chai Nat 72 (CN72) in 2000. It is the first mungbean variety released and developed through mutation techniques in Thailand. CN72 had lower beanfly infestation than a susceptible variety, CN36. The result of an addition trial conducted on calcareous soil showed that grain yield of mutant CN72 was superior to that of KPS2. The third experiment of the Mungbean Mutant Multi-location trials was conducted in two sites during 2003-2005. All mutants retained most traits of the original varieties, including yield. The highest yielding mutant across all five trials was CN72 which was similar to its progenitor (KPS2) and the local check, CN36. These three entries bore large seeds (70 g per 1,000 seeds), which is a desirable trait for Thai and international markets. An exotic entry, native variety showed least incidence of powdery mildew disease. It will be used as a source of disease resistance in the breeding programme.

Introduction

Mungbean (*Vigna radiata* (L.) Wilczek) is one of the most important grain legumes in Thailand, occupying an annual production area of over 300,000 ha. It can be grown during three seasons of the year, but the late rainy season, which starts between late August and September, is strongly recommended. Most of the annual mungbean production is used for bean sprouts. Therefore, germination and sprout quality are very important. Seven recommended mungbean varieties were cultivated from 1986 to 2000. They gave about 17-44% higher yield than local varieties. The popular varieties, Chai Nat 36, Khampang Saen 1 and Khampang Saen 2 are more resistant to major diseases, cercospora leaf spot (*Cercospora canescens*) and powdery mildew (*Oidium sp.*) (Thanomsub and Anat, 2005) [1]. Attempts have been made to develop new mungbean varieties by means of conventional breeding using mutation techniques and biotechnology.

Induced mutation using physical and chemical mutagens is one way to create genetic variation resulting in new varieties with better characteristics. The application of radiation and chemical mutation in mungbean

breeding for various aspects were undertaken. The selection and development of mutants into recommended varieties for farmers have been successfully made in many countries (Chow and Loo, 1988; Lamsrijan, *et al.*, 1988; Wongpiyasatid, *et al.*, 1998 and 1999) [2,3,4,5]. Sandhu and Saxena (2003) [6] studied 34 mungbean mutant lines and found high variation in yield per plant and nutritional quality, especially contents of protein, methionine, tryptophan, sulphur, phenol and total sugars.

Current status of mungbean and the use of mutation breeding in Thailand

Induced Mutations in mungbean breeding in Thailand

In Thailand, induction of mutations is used to improve mungbean variety for higher yield and higher resistance to diseases than the previous recommended varieties. Seeds of varieties Khampang Saen 1 (KPS1) and Chai Nat 36 (CN36) were irradiated with a dose of 500Gy Gamma-rays and treated with 1% ethyl methane sulphonate. A number of mutant lines were selected from M₂ generation onwards. Yield trials were conducted in field crop research centers and farmers' fields from 1997 to 2006. Preliminary comparison of yield in 1997 revealed that most mungbean lines had yield and other agronomic characters that were not statistically different from the standard checks. Yet, some lines gave higher yields with less powdery mildew infection than the checks. Twelve lines were then selected and compared for regional yield trial.

Three mutant lines, M4-2, M5-1 and M5-5, gave 8-11% and 2-5% higher mean yield than those of varieties KPS1 and CN36, but they showed similar disease infection to the two original varieties (Table 1). These three elite lines are being tested for yield and adaptability in farmers' fields for the possibility to release.

Table 1. Grain yield (t/ha) and disease reaction of three mutant lines of mungbean compared with two check varieties, yield trials 1997-2006

Mutant line & variety	PYT	SYT	RYT	FT	Mean (%)	Cercospora leaf spot	Powdery mildew
M4-2	2.06	1.47	1.50	0.66	1.42(108)	MR	MR
M5-1	2.15	1.52	1.50	0.66	1.46(111)	MR	MR
M5-5	2.12	1.43	1.48	0.68	1.42(108)	MR	MR
CN36	2.07	1.42	1.42	0.68	1.40(106)	MR	MR
KPS2	1.95	1.33	1.36	0.67	1.32(100)	MR	MR

Source: Ngampongsai *et al.* (2006)[9]

PYT=Preliminary Yield Trial, SYT=Standard Yield Trial, RYT=Regional Yield Trial, FT=Farm Trial
MR = Moderately resistant CN36= Chai Nat 36, KPS2= Kampaeng Saen 2

The use of induced mutations for mungbean improvement Beanfly (*Ophiomyia phaseoli* Tryon) is a key pest of mungbean in Thailand. Plants are infested at an early growth stage, often resulting in almost 100% plant death. In such circumstances, the plants that continue to grow remain stunted, and produce only a small yield. To

¹ Chai Nat Field Crops Research Center, Muang, Chai Nat 17000, Thailand

² OARD1, P.O.Box170, Chiang Mai University, Muang, Chiang Mai 50202, Thailand

³ Department of Agronomy, Faculty of Agriculture, Kamphaeng Saen, Kasetsart University, Nakhon Pathom 73140, Thailand

* Corresponding author. E-mail: sumana56@hotmail.com

control beanfly, apart from insecticide spraying, induced mutation is used to improve the resistance of mungbean variety. One thousand seeds of variety Khampang Saen 2 (KPS2) were irradiated with 600Gy Gamma-rays. Progression from M_2 to M_4 generations was made by the single seed descent method. The M_3 selection was made under natural field infestations. In the M_5 generation, individual plants were selected for yield trials conducted sequentially, from preliminary trials through to, regional, farm and field trials.

The preliminary trial was conducted at Chiang Mai Field Crops Research Center in 1989. Observation of 10 plants of the insect tolerant selection Chai Nat 72 (CN 72) revealed only four larvae and pupae, compared to 8.5 larvae and pupae on the susceptible variety CN 36. A trial conducted in farmers' fields in 1995 showed a similar result. The number of larvae and pupae infesting CN 72 was 23.3 per 10 plants, compared to 28.3 per 10 plants for CN 36. According to the method reported by Talekar (1990)[7], CN 72 has moderate resistance to beanfly, whereas CN 36 is susceptible (Table 2).

CN 72 also produced a slightly higher yield than CN 36 in each evaluation trial (Table 2). An experiment conducted on a calcareous soil found that CN 72 produced as high a yield as CN 36 with similar yield components (Table 3) and was superior to its parent to KPS 2 in this respect. In addition, CN 72 also showed less yellow leaves compared to KPS 2 (Table 3). The resistance of CN 72 to beanfly may be due to low attraction or lack of palatability to the pest. The assertion is supported by Lin (1981)[8] who found that a beanfly-resistant line, LM 192, is a non-preference for beanfly due to its low attraction, lack of palatability and dense pubescence.

A mutant line was selected and subsequently officially released as Chai Nat 72 (CN72) in the year 2000. It is the first mungbean variety released and developed through mutation techniques in Thailand. CN72 had lower beanfly infestation than a susceptible variety, CN36. In addition, an experiment conducted on calcareous soil showed that CN 72 yield was superior to the original variety KPS2.

Mungbean mutant multi-location trials in Thailand

The IAEA/RCA project RAS/5/040 enhancement of genetic diversity in food, pulses, and oil crops and establishment of mutant germplasm network was executed during 2003-2005 under the joint support of the participating countries and IAEA. The project activities include (1) conducting mutant multi-location trials, and (2) mutation enhancement of crop genetic diversity. For mungbean multi-location trial, Thailand has conducted five yield trials during 2003-2005. The details of the trials are reported hereafter.

Five experiments of the mungbean mutant multi-location trials were conducted in two research sites in Thailand, viz. Chai Nat Field Crops Research Center (latitude 15 : 15 N, longitude 100 : 15 E, elevation 16 m above sea level) and Kasetsart University- Kamphaeng Saen Campus (latitude 14 : 01 N, longitude 99 : 58 E, elevation 5 m above sea level). Both locations have loamy clay soil representing the major mungbean production area of the Kingdom.

Each trial was conducted in a Randomized Complete Block Design (RCBD) with three replications. Each plot comprised six rows each of 6 m long, with the spacing of 50 cm between rows and 15 cm between hills within the same row with two plants/hill (total population of ~ 300,000 plants/ha). Data were recorded from the four middle rows, leaving the distance of 50cm at each end of the rows. Thus the plot area for yield determination was 10m². Each trial was basally applied with 22.5, 45.0 and 22.5 kg per ha of N, P₂O₅ and K₂O prior to planting. The fields were irrigated as needed. In each trial, the data was deliberately collected from as many trial plots as possible.

The entries were nine pairs each of mungbean varieties and their corresponding mutants, plus a Thai local check (LM23-CN36). Thus, there were a total of 19 entries in the trials. The experiments were performed

in the late rainy season of 2003, dry and late rainy seasons of 2004 and the dry season of 2005. All the mutants retained the same hypocotyls color, seed coat color and seed coat luster as their original cultivars, except for entry no. 10 (LM14-1560xNM92) which has darker purple hypocotyls than its progenitor (LM13-NM92) (Table 4).

Table 2. Number of larvae and pupae of beanfly, yield of the mutant variety Chai Nat 72 compared with check varieties

Variety	No. of larvae and pupae per 10 plants		Resistant level	Yield ¹ (t/ha)
	CMFCRC	FF		
Chai Nat 72	4.0	23.3	MR	1.33
Chai Nat 36	8.5	28.3	S	1.27
Kampaeng Saen 2				

Source: Watanasit *et al.* (2001)[10]

CMFCRC= Chiang Mai Field Crops Research Center, FF= farmers' field in Chiang Mai
¹ yield trials conducted in research centers and farmers' fields from 1989-1995
 MR = Moderately resistant, S = Susceptible

Table 3. Yield, yield components and yellow leaf score of three mungbean varieties sown on a calcareous soil at Nakhorn Sawan Field Crops Research Center in 1993.

Variety	Yield (t/ha)	1,000 seed wt. (g)	No. of plant/pods	Yellow score ¹
Chai Nat 72	1.04a	60.6a	13.7a	2.0
Chai Nat 36	1.08a	60.5a	13.9a	1.0
Kampaeng Saen 2	0.66b	50.5b	7.5b	5.0

Source: Watanasit *et al.* (2001)[10]

¹ 1=normal leaf, 2=1-25% of leaf area turned yellow, 3=26-50% of leaf area turned yellow, 4=51-75% of leaf area turned yellow 5=76-100% of leaf area turned yellow due to Fe deficiency.

Table 4. Combined analysis of mungbean regional mutant multi-location trials from five locations conducted in Thailand during 2003-2005

	Entry Name	Hypocotyl color	Seed color	Seed coat luster
1	LM5-Camar	Green	Green	Shiny
2	LM6-PSj-B-II-17-6	Green	Green	Shiny
3	LM7-Gelatik	Green	Green	Shiny
4	LM8-Psj-S-31	Green	Green	Shiny
5	LM9-CV6601	Greenish purple	Green	Shiny
6	LM10-NM54	Greenish purple	Green	Shiny
7	LM11-NM20-21	Greenish purple	Green	Shiny
8	LM12-NM98	Greenish purple	Green	Shiny
9	LM13-NM92	Greenish purple	Green	Shiny
10	LM14-1560xNM92	Dark purple	Green	Shiny
11	LM15-NM51	Greenish purple	Green	Shiny
12	LM16-NM51xVC1973A	Greenish purple	Green	Shiny
13	LM17-2917A	Green	Green	Shiny
14	LM18-1-176	Green	Green	Shiny
15	LM19-Native Variety	Greenish purple	Yellow	Shiny
16	LM20-PACE3	Greenish purple	Yellow	Shiny
17	LM21-KPS2	Green	Green	Shiny
18	LM22-CN72	Green	Green	Shiny
19	LM23-Local Check CN36	Green	Green	Shiny

Source: Srinives *et al.* (2006)[11]

CN36 = Chai Nat 36, CN72 = Chai Nat 72, KPS2= Kampaeng Saen 2

All mutants retained most traits of the original varieties, including yield. The highest yielding mutant across five trials was CN72 (LM22) which was similar to its progenitor (KPS2) and the local check. These

three entries bore large seeds (70 g per 1,000 seeds), which is a desirable trait for Thai and international markets. The other large-seeded entries were LM6-Psj-B-II-17-6 and LM8-Psj-S-31, which gave lower yields than CN72. A number of desirable traits were observed in the entries that participated in the trial. LM5-Camar, LM9-CV6601 and LM11-NM20-21 had high number of seeds per pod. LM18-1-176 and LM19-Native varieties showed the least incidence of powdery mildew disease. These genotypes can be utilized in future mungbean breeding projects in the participating countries of the IAEA/RAS/5/040 Project (Table 5).

Table 5. Combined analysis of mungbean regional mutant multi-location trials from five locations conducted in Thailand during 2003-2005.

	Entry Name	No. of pods/plant	No. of seeds/pod	1,000 seeds wt. (g)	Seed yield (t/ha)	Powdery ¹ mildew (1-4)
1	LM5-Camar	18.1a	10.2c-e	43.0g	1.32ab	2.00de
2	LM6-Psj-B-II-17-6	11.7e	9.2h	72.4a	1.21b	2.23a-d
3	LM7-Gelatik	14.5bc	9.9e-g	54.5e	1.19b	2.33a-d
4	LM8-Psj-S-31	12.0c-e	9.7f-h	71.7a	1.22b	1.80de
5	LM9-CV6601	17.5a	11.1a	38.9h	1.24b	1.67de
6	LM10-NM54	11.4e	10.3c-e	63.2bc	1.36ab	2.43a-d
7	LM11-NM20-21	17.9a	10.9 ab	40.3gh	1.32ab	1.57de
8	LM12-NM98	15.9ab	10.5 b-d	43.4g	1.21b	1.90c-e
9	LM13-NM92	12.7c-e	9.5 gh	60.1cd	1.12b	2.20a-d
10	LM14-1560xNM92	13.0c-e	10.7 a-d	54.8e	1.26b	2.33a-d
11	LM15-NM51	14.2b-d	10.8 a-c	49.1f	1.33ab	3.33ab
12	LM16-NM51xV-C1973A	10.7e	10.5b-d	59.9cd	1.34ab	2.57a-d
13	LM17-2917A	13.0c-e	10.2 d-f	56.5de	1.28b	2.13b-d
14	LM18-1-176	12.4c-e	10.4 f-h	53.7e	1.33ab	1.43de
15	LM19-Native Variety	15.7ab	10.5 b-e	43.2g	1.13b	1.00e
16	LM20-PACE3	12.9c-e	10.5 c-d	65.6b	1.33ab	3.13a-c
17	LM21-KPS2	11.9de	10.4 b-e	69.9a	1.3ab	1.77de
18	LM22-CN72	10.9e	10.5 b-d	72.7a	1.59a	3.43a
19	LM23-Local Check CN36	11.1e	10.5 b-e	72.5a	1.40ab	3.43a
	CV(%)	2.6	4.2	5.2	18.3	34.2

Source: Srinives *et al.* (2006)[11]

¹ Visual rating score: 1 = no infection, 5 = severe infection

BIBLIOGRAPHY

1. Thanomsub, W., Watanasit, A. Mungbean and Blackgram. In: A guide Book for Fields Crops Production in Thailand, Field Crops Research Institute, Department of Agriculture, Ministry of Agriculture and Co-operatives, Bangkok, Thailand, p.152 (2005).
2. Chow, K.H., Loo, E.H. Mutation Breeding in Mungbean by Using EMS, In: Mungbean Proceedings of the Second International Symposium, Nov. 16-20, 1987, Bangkok p.178-185 (1998).
3. Lamseejan, S., Smutkupt, S., Wongpiyasatid, A., Naritoom K. Use of Radiation in Mungbean Breeding, In: Mungbean Proceedings of the Second, International Symposium, Nov. 16-20, 1987, Bangkok p.174-177 (1998).
4. Wongpiyasatid, A., Chotchuen, S., Hormchan, P., Srihattagum, M. Evaluation of Yield and Resistance to Powdery Mildew, Cercospora Leaf Spot and Cowpea Weevil in Mungbean Mutant Lines, Kasersart. *J. Nat. Sci.* **33**, 204-215 (1999).
5. Wongpiyasatid, A., Chotchuen, S., Hormchan, P., Ngampongsai, S., Lamsrijan, S., Pichitporn, S. Mutant Mungbean Lines from Radiation and Chemical Induction, Kasetsart. *J. Nat. Sci.* **32**, 203-212 (1998).
6. Sandhu, J.S., Saxena, A.K. Variability and Association of Nutritional Quality Traits of Mungbean Mutants. *Indian J. Pulses Res.* **16**(1), 54-55 (2003).
7. Talekar, N.S. Agronomy of Flies of Food Legumes in the Tropics, Wiley, Eastern Limited, Delhi, p.297 (1990).
8. Lin, S.A. Resistance of Beans to Insects, From N.S. Talekar, (1990). Agronomy of Flies of Food Legumes in the Tropics, Wiley Eastern Limited, Delhi, p.297 (1981).
9. Ngampongsai, S., Chotchuen, S., Wongpiyasatid, A. Induced Mutations in Mungbean Breeding Programme. In: Proceedings of the Ninth National Mungbean Research Conference, March 5-6 2004, Lampang-wiangthong Hotel Lampang. p.111-118 (2004) (in Thai).
10. Watanasit, A., Ngampongsai, S., Thanomsub, W. The Use of Induced mutations for Mungbean Improvement. Report of an FAO/IAEA Seminar on Mutation Techniques and Molecular Genetics for Tropical and Subtropical Plant Improvement in Asia and the Pacific Region. October 11-15, 1999. The Philippines. p.11-12 (2001).
11. Srinives P., Srisombun, S., Ngampongsai, S. Mungbean Mutant Multi-location Trials in Thailand. Paper presented at the IAEA/RCA Project Progress Review Meeting on Mutant Multi-location Trials and mutation Enhancement of Genetic Diversity, Jakarta, Indonesia, 13-17 March, (2006).

Intervarietal Differences in Response of Sunflower (*Helianthus annuus* L.) to Different Mutagenic Treatments

S Gvozdenovic^{1*}, S Bado², R Afza², S Jocic¹ & C Mba²

Abstract

For much of the past century, mutagenesis has gained popularity in plant genetics research as a means of inducing novel genetic variation. Induced mutations have been applied for the past 40 years to produce mutant cultivars in sunflower by changing plant characteristics that significantly increase plant yield and quality. The present study was focused on generating baseline data to elucidate the role of genotypic differences in the response of sunflower to induced mutagenesis with the aim of expanding the applicability of the use of induced mutant stocks in the genetic improvement of the crop and in its functional genomics. The strategy adopted was to estimate the optimal treatment conditions (doses of mutagens) through relating the extent of damage in seedling progeny to the exposure levels of the initiating propagules to mutagens. Seeds of 15 elite sunflower genotypes commonly used as breeding stocks and grown on commercial scales were treated with a range of mutagens: Gamma-rays (γ rays); fast neutrons and with ethyle-methane-sulphonate (EMS) at different treatment doses. The three mutagenic agents affected seedling height, reducing it with increasing dosage. Based on the mutagen damage on seedling height, the 50% and 30% damage indices (D_{50} and D_{30} , respectively) were estimated for the 15 sunflower genotypes for the three mutagens. The D_{50} (D_{30}) values for the sunflower lines ranged from 120 to 325Gy (5 to 207Gy) for gamma irradiation; 9 to 21Gy (0.1 to 10Gy) for fast neutrons and 0.69 to 1.55% (0.01 to 0.68%) concentration of EMS.

Introduction

Sunflower (*Helianthus annuus* L.) is one of the world's most important oil crops, used for human consumption and industrial processes. It is also used as a confectionery, ornamental plant and flower, and as bird feed. It is currently cultivated on over 21 million hectares world-wide annually. The largest sunflower producers in the world are Russia, the United States, Argentina, China, and France [1].

The main objective of sunflower breeding is to develop productive sunflower hybrid cultivars that are stable, high yielding, and resistant to biotic and abiotic stresses. Yield is a complex trait, is controlled by multiple gene effects. Seed yield is variously estimated as: number of plants per hectare (55,000-60,000), number of seeds per plant (>1,500), hectoliter mass of the seed (45-50 kg/ha), thousand seed mass (>80 g), low hull percentage (20-24%) and high seed oil content (>50) [2].

Induced mutations have been applied for the past 40 years to produce mutant cultivars in sunflower by changing plant characteristics for significant increase in plant productivity [3], [7]. Mutagenic treatments, usually on seed, have induced high-oleics, semi-dwarfs and dwarfs, male-sterile plants and other interesting variants such as earliness and seeds with thin hull [4], [5], [6].

In 1976, Soldatov produced a mutant of significant practical importance for sunflower breeding by treating the seed of the cultivar VNIIMK 8931 with a solution of 0.5% dimethyl-sulphate (DMS); M_3 lines possessing a high content of oleic acid in oil were obtained. After further breeding, the high-oleic cultivar Pervenetz was developed [4]. The high oleic content of this cultivar has proved to be very stable under varying temperatures and the trait can be easily transferred into other genotypes by normal breeding procedures.

The main objectives of this research were to increase genetic variation in sunflower inbred lines and to assess the efficiency of different mutagenic treatments, since basic information on this is lacking. The first step was to estimate optimal treatment conditions (doses). Germination of the M_1 seed provides a good test of the sensitivity of the material to the mutagenic treatment.

Materials and Methods

Fifteen genetically different sunflower inbred lines chosen for their importance in commercial hybrid production (**Table 1**) were used for this study. Seed of these genotypes varied morphologically. The Institute of Field Vegetable Crops, Novi Sad, Serbia, supplied the seeds.

For gamma irradiation, 50 seeds of each genotype were irradiated at 100, 200, 300, 400 and 500Gy using a Cobalt-60 gamma source at the IAEA Laboratories in Seibersdorf, Austria. Prior to mutagenic treatment, the seeds were kept in a desiccator over a 60 % glycerol/water mixture for seven days at room temperature for seed moisture equilibration.

For fast neutron treatment, 50 seeds were treated with five different doses: 10, 20, 30, 40 and 50Gy at the Atomic Energy Research Institute, Budapest, Hungary. The samples were bombarded inside a cadmium (Cd) capsule with wall thickness of 2mm. Exposure temperature was less than 30°C, at normal air pressure and humidity was less than 70%. The samples were rotated at 16 revolutions per minute. Ten days after the treatment, 25 seeds of each genotype were sown and germinated to assess radiosensitivity.

For chemical treatment, seeds were pre-soaked in distilled water for 24 hours. Twenty-five seeds of each genotype were treated with five concentrations of ethyle-methane-sulphonate (EMS) solution, 0.5, 1.0, 1.5, 2.0 and 2.5%, for 3.5 hours; treatment concentrations were based on studies of other species [8]. After EMS treatment, the seeds were washed and sown. The control, non-mutagenized seeds were treated similarly, except for exposure to the mutagen.

The treated seeds and the controls were sown in boxes in three replications using the flat method [9] in a glasshouse under controlled environmental conditions (22-35°C, lighting of 12-hour photoperiod). The parameter used to assess the dose response was the seedling height. The measurements were taken when cotyledons emerged above the soil and had split up (12 days after sowing).

The mean seedling height of the control was used as an index of the normal growth of each inbred line. The mean seedling height of each treatment was expressed as a percentage of the corresponding control value. Based on these values, regression equations were obtained.

¹ Institute of Field and Vegetable Crops (IFVC), Oil Crops Department, Novi Sad, Serbia

² Plant Breeding Unit Joint FAO/IAEA Agriculture and Biotechnology Laboratory, International Atomic Energy Agency Laboratories, Seibersdorf, Austria

* Corresponding author. E-mail: sandra@ifvcns.ns.ac.yu

Radiobiological effects of mutagenesis were observed in the M_1 and calculated on the basis of the absorbed dose or EMS of the seedling height. According to [10] and [11] seedling height reduction of 30-50% is generally assumed to give high mutation yield. Seedling height is highly correlated to survival [12]. This is usually designated as D_{30} and D_{50} , respectively.

Table 1. List and characteristics of treated sunflower inbred lines

Inbred lines	Type of inbred line	Branching	Days to flowering	Plant height (cm)	Oil content (%)	Seed size ratio	Thousand seed mass (g)	Seed color	Seed coat type
HA-26	Standard female(B analogue)	no	62	126	44	0.39	46.15	black	thick
VL-A-8	Standard female(B analogue)	no	65	108	47	0.5	38.42	black	thick
HA-48	Standard female(B analogue)	no	72	150	48	0.49	44.30	black	thick
HA-19	Standard female(B analogue)	no	56	80	47	0.53	50.70	black	thick
OD-3369	Standard female(B analogue)	no	71	105	55	0.42	52.16	black	thick
V-8931-3-4-OL	High oleic	yes	73	95	54	0.47	47.47	black	thin
HA-26-OL	High oleic	no	65	119	47	0.40	51.96	black	thick
VK-66-tph ₁	Altered tocopherol quality	yes	57	75	41	0.42	46.28	black	thick
VK-66-tph ₁ tph ₂	Altered tocopherol quality	yes	58	64	37	0.47	52.46	black	thick
VK-66-OL-tph ₂	High oleic and altered tocopherol quality	yes	60	68	28	0.44	50.96	black	thick
RUS-RF-168	Standard restorer	yes	74	134	40	0.49	38.31	black	medium
RHA-SELEUS	Standard restorer	yes	71	112	47	0.45	32.49	brown	medium
RHA-M-72	Standard restorer	yes	70	114	51	0.38	41.38	brown	thin
CMS-ANN-15	Standard restorer	yes	53	33	35	0.37	41.12	black	thin
RHA-S-OL-26	High oleic restorer	yes	69	88	55	0.38	28.43	cream	medium

Three mutagenic agents were used

Results and Discussion

All seeds, the control and the irradiated, germinated. The seedling height in all three treatments decreased with increasing dose. For gamma irradiation the D_{50} and D_{30} values for the 15 sunflower inbred line seeds ranged from 120Gy and 5Gy, respectively for inbred line HA-19 to 325Gy and 207Gy, respectively for genotype VK-66-tph₁. For fast neutron, the D_{50} and D_{30} for seeds of the 15 sunflower inbred lines seeds ranged from 9Gy and 0.1Gy, respectively (genotype HA-19) to 21Gy and 10Gy, respectively (genotype VK-66-tph₁tph₂). The trend was therefore similar to the responses to gamma irradiation by these genotypes. The D_{50} and D_{30} values for these 15 sunflower inbred line seeds treated with EMS ranged from 0.69% and 0.01%, respectively EMS concentration

(genotype OD-3369) to 1.55% and 0.68%, respectively for the line HA-19 (Table 2).

The data indicated that all genotypes produced a wide range of responses. With respect to radiation damage by Gamma-rays, the genotype HA-19 showed the least radiation damage with VK-66-tph₁ displaying the highest damage. In the case of fast neutron, the genotype HA-19 was most affected while VK-66-tph₁ and VK-66-tph₁tph₂ had the least radiation damage. The study of EMS revealed OD-3369 to be least sensitive while VK-66-tph₁tph₂ again was highly susceptible. Reduction of seedling height was more pronounced in genotype HA-19 than any other genotype for both gamma and fast neutron irradiation and clearly demonstrated a genotypic response to mutagenic treatment. Interestingly, the same genotype showed the greatest resistance to high doses of EMS, inferring again a genotype - mutagen interaction. This line is very early maturing and it has round and large seed. Lines OD-3369 and V-8931-3-4-OL were generally more sensitive to all three mutagens than the others. These inbreds have very high oil contents in the seeds, normal sized seeds and high thousand seed mass. Inbred lines VK-66-tph₁, VK-66-tph₁tph₂ and VK-66-OL-tph₂ showed the greatest resistance to both physical and chemical mutagenic treatments. These genotypes are nearly isogenic lines, with different oil quality but low oil quantity. They have large, black seeds but a thick coat that is probably the reason for such high resistance to mutagenic treatments.

Table 2. D_{50} and D_{30} values for 15 inbreds for exposure to Gamma-rays, fast neutron bombardment and EMS solution

Genotypes	Gamma-rays (GY)			Fast neutrons (GY)			EMS (%)		
	D_{50}	D_{30}	S_e	D_{50}	D_{30}	S_e	D_{50}	D_{30}	S_e
HA-26	202	102	13.28	15	3.6	19.00	1.34	0.50	13.44
VL-A-8	218	100	12.54	12	0.6	22.95	1.41	0.55	12.03
HA-48	220	109	11.84	17	3.8	18.75	1.40	0.58	13.68
HA-19	120	5	22.76	9	0.1	25.67	1.55	0.68	9.82
OD-3369	151	18	20.34	11	0.08	24.56	0.69	0.01	22.39
V-8931-3-4-OL	155	44	15.96	13.5	1.5	21.21	0.82	0.07	22.95
HA-26-OL	181	76	13.39	12.5	1	22.27	1.16	0.43	14.16
VK-66-tph ₁	325	207	9.03	20	9	15.50	1.41	0.53	13.75
VK-66-tph ₁ tph ₂	294	151	6.90	21	10	12.61	1.54	0.64	11.79
VK-66-OL-tph ₂	289	164	3.45	19	8	16.14	1.36	0.55	14.78
RUS-RF-168	201	101	14.33	20	7.3	20.86	1.09	0.30	14.88
RHA-SELEUS	206	95	13.43	15	2.6	21.80	1.15	0.39	12.40
RHA-M-72	188	93	19.03	13	1.7	22.34	1.46	0.62	16.91
CMS-ANN-15	237	146	14.89	13	0.4	20.52	0.94	0.25	13.51
RHA-S-OL-26	197	79	12.89	14.5	2	15.11	1.36	0.50	16.17

The three mutagenic agents affected seedling height, reducing it with increasing dosage. Based on the mutagen damage on seedling height, the D_{50} and D_{30} values for 15 sunflower genotypes were estimated for the three mutagens. Retardation of growth due to the mutagenic treatments has been used to determine the dose rate for mutation induction. It is

the most functional parameter to be used in radiobiological investigations because it is generally considered to be a result of primary injury due to nuclear DNA damage. Sensitivity in seedlings height had been demonstrated in earlier dose response studies of bean [13], soybean [14], and other crops.

In this experiment, we established relationships between the D_{50} values due to gamma and fast neutron irradiation and EMS to the thousand seed mass (TSM), seed size ratio, oil content in the seed, plant height and days to flowering (Table 3). A significant negative correlation was found between the treatment and seed oil content, indicating that genotypes with relatively high seed oil content were more sensitive to gamma irradiation, fast neutrons and EMS. Also, larger seeds were generally more resistant to EMS treatment than to gamma and fast neutron irradiation. There was a negative correlation between early flowering, short stature plants and gamma irradiation. Mutagenic damage depended on the biological traits of the variety.

Table 3. Correlations between biological traits and response to mutagenic treatments

Biological traits	Gamma-rays	Fast neutrons	EMS
TSM	0.15	0.00	0.14
Seed size ratio	-0.17	-0.18	0.38*
Oil content	-0.69**	-0.37*	-0.39*
Plant height	-0.39*	-0.20	0.11
Days to flowering	-0.41*	-0.14	-0.24

$r(0.05)=0.349$ $r(0.01)=0.449$

The results obtained from this study indicated that the radiation damage due to mutagenic treatment was not similar amongst the genotypes. The same differential response to radiation among different genotypes in plant species was reported by many researchers. These inter-varietal differences in radiation damage to seeds have been reported to be: a) under polygenic system in rice, tomato and barley [15], [16], [17], [18], [19], b) major gene control in einkorn wheat and soybean [20], [21], and c) influenced by heterozygosity in maize and peanut [22], [23], [24]. It is widely accepted that response to mutagens is species and genotype dependent, but the full explanation has not yet been provided.

The different D_{50} (D_{30}) values for sunflower inbreds were established: dose range of 120 to 325Gy (5 to 207Gy) for gamma irradiation, 9 to 21Gy (0.1 to 10Gy) for fast neutrons irradiation and 0.69 to 1.55% (0.01 to 0.68%) concentration of EMS. The radiation sensitivity studies indicated that all the genotypes treated exhibited a wide range of radiation damage to Gamma-rays and fast neutrons.

Based on the radiation damage, bulk irradiation with a dose giving rise to a 30% to 50% reduction in growth will be carried out and M_1 plants will be grown in the field. Different mutations will be observed in the field and promising mutants will be selected for further testing. Selection will be carried out in the M_2 generation for early flowering, short stature, deformations of leaves and heads, appearance of branches, head inclination, sterility and oil seed quantity and quality.

ACKNOWLEDGMENTS

This work was supported by Ministry of Science of the Republic of Serbia.

BIBLIOGRAPHY

- Skorić, D. Sunflower breeding. *Journal of Edible Industry*, Uljarstvo, **25**, 3-75 (1989).
- Skorić, D. Dostignuća i dalji pravci u oplemenjivanju suncokreta. Suncokret (monografija), Nolit, Novi Sad, 285 (1989).

- Jain, S.M. Major mutation- assisted plant breeding programmes supported by FAO/IAEA, *Plant Cell, Tissue and Organ Culture* **82**, 113-123 (2005).
- Soldatov, K.I. Chemical mutagenesis in sunflower breeding. p. 352-357. In Proc. 7th Int. Sunflower Conf., Krasnodar, USSR. 27 June-3 July 1976. Int. Sunflower Assoc., Vlaardingen, The Netherlands (1976).
- Voskoboinik, L. K., Soldatov, K. I. The research trends in the field of sunflower breeding for heterosis at the All-Union Research Institute for Oil Crops (VNIIMK). In Proc. 6th Int. Sunflower Conf., Bucharest, Romania. 383-389 (1974).
- Jan, C.C., Rutger, J.C. Mitomycin C- and streptomycin- induced male sterility in cultivated sunflower. *Crop. Sci.* **28**, 792-795 (1988).
- Miller, J.F., Fick, G.N. The Genetics of Sunflower. Sunflower Technology and Production, (Schneiter, A. A. ed.). 395-439 (1997).
- Kodym, A., Afza, R. Physical and Chemical Mutagenesis, in Plant Functional Genomics (Grotewold, E., ed.). Humana Press, Inc., Totowa, NJ. **236**, 189-203 (2003).
- Gaul, H. Mutationen in der Pflanzenzüchtung. *Z. Pflanzenzücht.* **50**, 194-307 (1963).
- Brunner, H. Radiation induced mutations for plant selection. *App. Radiat. Isot.* **46**, 589-594 (1995).
- Karma, O.P., Brunner, H. Chemical mutagens: dose, in Manual on Mutation Breeding, IAEA Technical Reports Series, No. **119**, 2nd ed., 66-69 (1977).
- Manual on Mutation Breeding, International Atomic Energy Agency, Vienna, 91.
- Cheah, Ch., Lim, E.S. Mutagenesis applied to the improvement of *Phaseolus vulgaris* as a grain legume crop in Malaysia. Induced mutation s for improvement of grain legumes production II. IAEA TECDOC-260 (109-116). IAEA, Vienna (1982).
- Koo, F.K.S., Ferrer-Monge, J.A., Otero, A.M., Abulla, I., Almany, A. Effect of fast neutron and Gamma-rays on soybean seedling growth and malate-dehydrogenase isozyme pattern after seed irradiation. Neutron irradiation of seed. III. Technical report series, IAEA, Vienna, **141**, 95-103 (1972).
- Ukai, Y. Studies on varietal differences in radiosensitivity in rice -I Dose response curve for root growth and varietal difference in radiosensitivity. *Japan J. Breed.* **17**, 33-36 (1967).
- Davies, D.R. The genetical control of radiosensitivity I. Seedling characters in tomato. *Heredity* **17**, 63-74 (1962a).
- Davies, D.R. The genetical control of radiosensitivity II. Growth measurements in *Lycopersicon* and *Melandrium*. *Radiat. Bot.* **1**, 277-295(1962b).
- Ukai, Y., Yamashita, A. Varietal differences in radiosensitivity with special reference to different aspects with different crops. *Gamma Field. Symp.* **8**, 69-81 (1969).
- Koyama, Y., Saito, M., Kawase, T. Absence of storage effects on radiation damage after thermal neutron irradiation of dry rice seeds. *Japan J. Breed.* **37**, 301-310(1987).
- Smith, L. Hereditary susceptibility to X-ray injury in Triticum monococcum. *Am. J. Bot.* **29**, 189-191 (1942).
- Takagi, Y. The second type of gamma sensitive gene RS2 in soybean *Glycine max* (L.) Merrill. *Gamma Field Symp.* **8**, 83-94 (1969).
- Notani, N.K. A study of differences in the radiosensitivity of some inbreds and hybrids in maize. In: *Effects of ionizing radiations on seeds*. IAEA, Vienna, 475-484 (1961).
- Stoilov, M., Jansson, G., Eriksson, G., Ehrenberg, L. Genetical and physiological causes of the variation of radiosensitivity in barley and maize. *Radiat. Bot.* **6**, 457-467(1966).
- Emery, D.A., Boardman, E.G., Stucker, R.E. Some observations on the radiosensitivity of certain varietal and hybrid genotypes of cultivated peanuts (*Arachis hypogaea* L.). *Radiat Bot.* **10**, 269-272 (1970).

A New Mutant for Yellow Mosaic Virus Resistance in Mungbean (*Vigna radiata* (L.) Wilczek) Variety SML-668 by Recurrent Gamma-ray Irradiation

K S Reddy

Abstract

The mungbean variety SML-668 is early, high-yielding and large-seeded but susceptible to yellow mosaic virus (YMV) disease. To develop YMV resistance in SML-668, a mutation breeding programme has been undertaken. Seeds of SML-668 were irradiated with 600Gy Gamma-rays and planted in the field. Three thousand plants in M_1 generation were harvested separately and planted in M_2 . Ninety lines showed sterility and only 10 lines showed mutants for chlorophyll, small seed size, short pod length, dwarf plant type and profuse branching, but there was no YMV-resistant mutant. All the mutants along with normal plants of the segregating lines were harvested separately in M_2 . In M_3 generation 2,500 normal lines were planted as single plant progenies and screened for YMV resistance and did not observe any YMV resistant mutant. Hence, the normal M_3 lines were made into two separate bulks and one bulk was irradiated with 500Gy as a recurrent irradiation and another was sown as it is. In M_3M_1 generation, a mutant showing very minor leaf symptoms for YMV, and without any pod symptoms was isolated. The mutant was purified by growing up to M_3M_6 generations. All the mutant plants showed very minor leaf symptoms but no symptoms in the pod. The pods and seeds were normal and also gave normal yield as compared to highly resistant check where two recessive genes controlling resistance is reported. The susceptible plants showed leaf and pod symptoms and showed severe yield losses. This mutant was used in crossing programme to study the genetics of YMV resistance.

Introduction

Mungbean (*Vigna radiata* L. Wilczek) is an important crop in India as well as in South East Asia. In India it is cultivated on 3.2 million hectares and the production is 0.95 million tons, with an average yield of 304 kg/ha [1]. The mungbean average yield fluctuates between 300 to 500 kg/ha for a decade in India. The yield losses (40-100%) reported due to biotic stresses is responsible for the fluctuation in the average yield. The biotic stresses like yellow mosaic virus (YMV), powdery mildew (PM) and *Cercospora* leaf spot (CLS) are major limiting factors for high yield. YMV disease has been reported to cause 32-78% reduction in grain yield under field conditions [2]. In mungbean, YMV disease resistance is governed by two recessive genes [3,4,5 and 6]. Thakur, *et al.* [7] showed that resistance was controlled by a single recessive gene. Two complimentary recessive genes controlling resistance to YMV have also been reported [8]. Considering the recessive nature of resistance, an induced mutation study was undertaken to develop YMV resistance in mungbean variety SML-668, which is early-maturing, high-yielding and suitable for summer cultivation in India, but is susceptible to YMV disease.

Materials and Methods

Seeds of mungbean variety SML-668 were used for mutation studies. Seven thousand seeds were irradiated with 600Gy Gamma-rays. The M_1 was raised in the field and normal cultural practices of mungbean were followed. The germination percentage was recorded in M_1 . Three thousand single plants from M_1 were harvested and planted as single plant progenies in M_2 and screened for YMV resistance under field infected conditions. Since no YMV resistant mutants were observed in M_2 , about 2,500 lines, which did not show any mutants were advanced to M_3 and screened for YMV resistance in the field. No YMV resistant mutants were observed even in M_3 . The entire population was harvested and pooled into two bulks and one of them was irradiated with 500Gy Gamma-rays as recurrent irradiation and the second bulk was planted as control to raise M_3M_1 and M_4 generations respectively. In the M_3M_1 , a mutant with minor YMV symptom on leaf but no symptoms on pod was isolated and purified by raising up to M_3M_6 .

The following crosses were made to study the minor leaf symptom YMV pod resistant mutant (MLYMVPR mutant) inheritance. The SML-668 x MLYMVPR mutant and MLYMVPR mutant x Kopergaon crosses were made and the F_1 , F_2 and F_3 were screened for YMV disease.

Results

Mutation studies

After irradiation of 7,000 seeds of SML-668 with 600Gy Gamma-rays, only 4,060 (58%) seeds germinated in M_1 . At the time of harvest 3,000 plants could be harvested individually as single plants and planted as plant to-row progenies in M_2 . In M_2 90 lines showed sterility and only 10 lines showed the mutants for characters like chlorophyll, seed size, pod length, plant type and branching plant types (Table 1). Thus, the 600Gy Gamma-ray treatment was effective in inducing mutations in SML-668 variety. The remaining 2,900 lines did not show any mutations. Although high incidence of YMV disease prevailed in the field, no mutant for YMV resistance could be observed in M_2 . From the 2,900 M_2 lines, about 2,500 plants were selected randomly and advanced to M_3 . The M_3 population was screened for YMV disease under severe field infected conditions and no YMV resistant mutant could be isolated. Hence, the normal M_3 lines were pooled into two separate bulks, one of them was irradiated with 500Gy Gamma-rays as recurrent irradiation and the second one was advanced as it is. The treated bulk was planted as M_3M_1 and rest as M_4 . In M_3M_1 a mutant, showing minor leaf symptoms for YMV and without any disease symptoms on the pod was isolated (Fig. 1). The mutant was purified by growing to M_3M_6 and screened for YMV pod resistant character. This character showed consistent performance in further generations. Although minor leaf symptoms were observed on leaves of mutant plants, no symptoms were observed on pods in any generation, even under high severity and incidence of YMV infection. The susceptible parent SML-668 and susceptible check Kopergaon were infected and expressed YMV symptoms on both leaves and pods reducing the yield considerably. The MLYMVPR mutant gave normal green pods with well-developed seeds compared to susceptible plants.

Nuclear Agriculture and Biotechnology Division, Bhabha Atomic Research Center, Trombay, Mumbai 400 085, India

E-mail: ksreddy122@yahoo.co.in

Inheritance studies

The MLYMVPR mutant was used in hybridization with susceptible genotypes to study the inheritance. The SML-668 x MLYMVPR mutant and MLYMVPR mutant x Kopergaon crosses were screened for YMV reactions in F₁, F₂ and F₃. The F₁ plants were susceptible, showing symptoms on both leaves and pods. In F₂, the segregation was 3:1 for susceptible (leaf and pod infection) and leaf minor symptom YMV pod resistant characters respectively and segregation showed good fit to 3:1 ratio (Table 2). The F₃ segregation was one true breeding for susceptible (leaf and pod infection): two segregating for susceptible (leaf and pod infection) and minor leaf symptom YMV pod resistant reactions : one true breeding for minor leaf symptom YMV pod resistant characters and showed good fit for 1:2:1 ratio and confirmed the F₂ segregation (Table 2).

Table 1. Mutation frequency with respect to parent and mutant characteristics in M₂ of SML-668 mungbean variety

Mutation affecting characters	Parent characters	Mutant characters	No. of mutants isolated	Mutation frequency
Chlorophyll	Green	Chlorina	17	0.018
Chlorophyll	Green	Virescent	4	0.004
Growth habit	Tall (40-60cm)	Dwarf (20-35 cm)	18	0.020
Branching habit	2-4 branches per plant	4-6 branches per plant	5	0.005
Pod length	8-10 cm	4-6 cm	8	0.008
Seed size (100 seed weight)	Large seed size (5-6 g)	Small seed size (3-4 g)	14	0.015

Table 2. Inheritance studies of minor leaf YMV pod resistant mutant (MLYMVPRM) in F₂ and F₃

Crosses	Reaction scores of F ₂ & F ₃ and the number of plants			Total F ₂ & F ₃ plants	χ ² value for 3:1	P-value
	S	S: M (seg.)	M			
SML-668 x MLYMVPR (F ₂)	231		86	317	0.766	0.5-0.3
Kopergaon x MLYMVPR (F ₂)	137		51	188	0.454	0.7-0.5
SML-668 x MLYMVPR (F ₃)	73 (TB)	151	82	306	0.563	0.8-0.7
Kopergaon x MLYMVPR (F ₃)	41 (TB)	87	46	174	0.287	0.9-0.8

TB= true breeding; S=susceptible; Seg=segregating; M= MLYMVPR mutant



Figure 1 (A) Minor leaf symptom YMV pod resistant (MLSYMVPR) mutant showing leaf symptoms and no pod symptoms. (B) Susceptible plant showing both leaf and pod symptoms.

Discussion

Mungbean yellow mosaic virus disease is a serious problem in India. SML-668 is a short duration (55-65 days) variety suitable for cultivation in the summer season under irrigated conditions which brings additional

area under mungbean cultivation in India. But YMV disease is a major disease which can reduce the productivity to a great extent. Although SML-668 has many required characters for summer cultivation, it is highly susceptible (symptoms present on leaves and pods) to YMV disease. Induced mutation study was chosen to develop YMV disease resistance in SML-668 because the YMV resistance is recessive in nature and is controlled by two recessive genes and segregation for susceptibility and resistance was reported as 15:1 ratio [3,4,5 and 6]. It is assumed that the presence of any one dominant gene can result in susceptible reaction. These studies suggest that susceptibility is dominant over resistance. In another study conducted by Thakur, *et al* [7], the resistance was controlled by a single recessive gene. The recessive and two complimentary genes controlling resistance of YMV have also been reported [8]. The present study showed that the induction of mutation for YMV resistance in M₂ was not easy because getting simultaneous mutations in two dominant susceptible genes is extremely difficult in a single exposure of Gamma-rays. Hence, recurrent irradiation was chosen in this study. In this study a mutant isolated for minor leaf symptom YMV pod resistance (Fig. 1) is not comparable with the resistance controlled by two recessive genes where no symptoms were observed on both leaves and pods, but comparable in yield with respect to protected or resistant plants. The MLYMV pod resistant mutant when crossed with susceptible SML-668 (susceptible parent) and Kopergaon (susceptible check) the F₁ was susceptible and F₂ segregated in a 3:1 ratio for susceptible and mutant characters and 1:2:1 genetic ratio in the F₃ generation confirmed the F₂ segregation (Table 2). The present investigation showed that resistance in the minor leaf YMV pod resistant mutant is controlled by a single recessive gene. It is assumed that the two recessive genes involved in controlling complete resistance may have a major and a minor gene. The mutant obtained in this study is proposed as a major gene since it gives maximum protection from YMV disease. This hypothesis also supports the results obtained by Shukla and Pandya [8] where a single recessive and two complimentary recessive genes controlled YMV resistance. To confirm this hypothesis, a second recessive mutant gene has to be obtained. The resistant mutant obtained in this study is effective in reducing the yield losses by YMV disease compared to the SML-668 and is expected to give stable yield in summer cultivation. Further mutation studies will be aimed to target the second dominant susceptible gene for differentiation and characterization of two recessive genes controlling complete resistance.

BIBLIOGRAPHY

- Singh, B.B. Project Coordinators report. Indian Council of Agricultural Research. Indian Institute of Pulses Research. All India Coordinated Research Project on MULLARP. Annual Group Meet, India (2008).
- Khattak, G.S.S. *et al*. Genetics of mungbean yellow mosaic virus (YMV) in mungbean (*Vigna radiata* L. Wilczek). *J. Genet. Breed.* **54**, 237 (2000).
- Shukla, G.P. *et al*. Inheritance of resistance to yellow mosaic in mungbean (*Vigna radiata* L. Wilczek). *Ind. J. Genet. Plt. Breed* **38**, 357 (1978).
- Singh, D.P. Breeding for resistance to mungbean yellow mosaic virus in mungbean (*Vigna radiata*) and urdbean (*Vigna mungo*). *Ind. J. Genet. Plt. Breed* **42**, 348 (1982).
- Saleem, M. *et al*. Inheritance of yellow mosaic virus in mungbean (*Vigna radiata* L. Wilczek). *Pak. J. Phytopath.* **10**, 30 (1998).
- Singh, S.K., Singh, M.N. Inheritance of resistance to mungbean yellow mosaic virus in mungbean. *Ind. J. Pulses Res.* **19**, 21 (2006).
- Thakur, R.P. *et al*. Genetical relationships between reactions to bacterial leaf spot, yellow mosaic virus and *Cercospora* leaf spot diseases in mungbean (*Vigna radiata*). *Euphytica* **26**, 765 (1977).
- Shukla, G.P., Pandya, B.P. Resistant to yellow mosaic in greengram. *SABRAO J.* **17**, 165 (1985).

Isolation of Early Flowering Mutant in Cultivar C-306 Known for its Good Chapati-making Quality

B K Das* & S G Bhagwat

Abstract

About 85% of wheat grains produced in India are consumed in the form of *chapatis* or its variant form. Wheat varieties released in India have acceptable *Chapati*-making qualities, however, the variety C-306 is quoted for its excellent *Chapati*-making quality. Good *Chapati*-making quality requires medium strong dough and is influenced by protein content and protein quality. The variety C-306 is medium tall and late in flowering, and thus not suitable for large-scale cultivation. To reduce the duration of the variety, γ -ray induced mutagenesis was used. Mature seeds were irradiated with 200, 300, or 400Gy. About 400 plants in the M_1 generation were harvested individually and planted in the M_2 generation as plant to row progenies. In the M_2 generation, mutants that flowered early and showed reduction in height were observed. The mutants were carried forward in M_3 and M_4 generation as plant to row progenies. Although there were minor segregations in the lines, the early flowering and maturity behavior was consistent. The parent showed anthesis in about 75 days while the mutants showed anthesis from 50 to 63 days. Seven mutant lines were selected for quality analysis. These lines in the M_2 generation showed anthesis in 50 days, maturity in 90 days, and grain protein content ranging from 11.9 to 14.9% as compared to 13.1% in the parent. SDS-PAGE of total grain protein showed that the mutants had unaltered high-molecular-weight glutenin subunit pattern. Rheological properties were estimated using Brabender Farinograph. The mutants had comparable water absorption, dough development time, dough stability, degree of softening and quality number. The early mutants are being monitored for yield and quality parameters and are expected to retain good quality and possess improved agronomic characteristics.

Introduction

Wheat is the second most important crop in India in terms of area under cultivation and annual grain production. Nearly 85% of wheat grains are consumed in the form of *chapatis* or its variant form [1]. In recent years wheat varieties have been released which have acceptable *Chapati*-making qualities, however, the variety C-306 released in the year 1965 from HAU, Hissar is often quoted for its excellent *Chapati*-making properties [1, 2]. Good *Chapati*-making quality requires medium strong dough, and although it is not characterized in terms of biochemical components, *Chapati*-making quality is influenced to a considerable extent by the protein content and protein quality. The variety C-306 has agronomic characteristics that are not suitable for its large-scale commercial exploitation. The variety is medium tall and late in flowering [3]. Due to late flowering it often matures when the temperature starts rising at the end of winter season, and as a result, the grain filling is hampered. By reducing the duration of flowering and reducing the height, the suitability of the variety for large-scale cultivation can be improved. Direct mutants have been reported to be useful in cultivation [4]. This study

reports isolation and quality assessment of Gamma-ray-induced early maturing mutants in the bread wheat variety C-306.

Materials and Methods

Mature seeds of C-306 were irradiated with 200, 300 or 400Gy dose of Gamma-rays and M_1 was raised in the experimental field at Trombay. The seeds of M_1 plants were harvested individually and planted in the M_2 generation as plant-to-row progenies.

The seeds of mutants isolated in the M_2 were harvested and subsequently grown as M_3 , M_4 and M_5 as plant-to-row progenies. Days to anthesis and maturity were recorded in each generation.

The bulk harvests were used to estimate thousand kernel weight. Three replicates of 100 kernels were used to calculate 1,000-kernel weight.

Grain protein percentage was estimated by the Kjeldahl method using Kjeltec™ 2300 system (Foss Tecator). HMW-glutenin subunits were analyzed using SDS-PAGE according to Bhagwat and Bhatia (1993) [5]. Five grain bulks from each mutant line were used as sample to check the HMW-subunit patterns.

Rheological properties were estimated using Brabender Farinograph E (Brabender, Germany).

Bulk harvest of each mutant line was milled using Tecator mill (0.8mm sieve). The whole meal was sieved through 40mesh sieve to obtain flour. Ten grams flour was used to determine water absorption percentage. Subsequently 10 gram samples were used to estimate dough development time, stability, degree of softening and quality number using the predetermined water absorption (Brabender /ICC method).

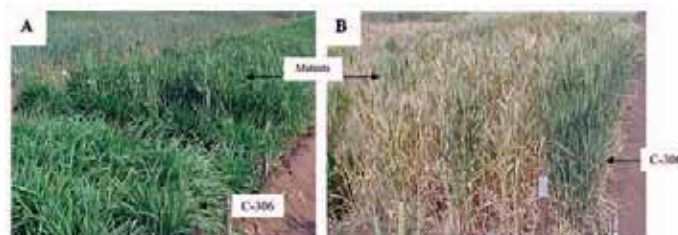

Figure 1 (A) Field view showing C-306 parent in the foreground and early flowering mutant (M_2) in background; (B) C-306 parent (extreme right) at grain filling stage and early mutant lines in M_5 generation nearing maturity.

Results

Raising the M_1 generation

In the M_1 generation the germination percentage was 29% (400Gy) to 88% (200Gy) compared to 91% in control.

Identification and evaluation of mutants

About 400 plants in M_1 generation were harvested individually and planted in the M_2 generation as plant-to-row progenies. In the M_2 generation that consisted of the 400 lines (~10,000 plants), mutants that flowered early and also showed reduction in height were observed. The

Nuclear Agriculture and Biotechnology Division, Bhabha Atomic Research Center (BARC), Trombay, Mumbai-400 085, India

* Corresponding author. E-mail: bikram_das2001@yahoo.com

mutants were carried forward in the M_3 (35 lines) and M_4 (30 lines) (Fig. 1A) generations as plant-to-row progenies. Although, there were minor segregations in these lines, the early flowering and maturity behavior was observed consistently. The parent variety showed anthesis in about 75 days from sowing while the different mutants showed anthesis from 55 days to 63 days.

M_5 generation

Twenty-three superior lines were carried forward to the M_5 generation. Each line was grown as three-meter row. These lines showed anthesis in 50 to 61 days. Seven lines (Table 1) that showed uniform height, anthesis time and good vegetative growth were selected for further analysis. The thousand kernel weight of five of the mutants were numerically higher than the parent (Table 1).

Table 1. Comparison of parent variety C-306 and mutants in M_5 generation for agronomic and quality traits

Sr. No	Parent/ Mutant	TKW (g)	HMWG subunits	Protein %	Water absorption (%)	Dough development (min)	Stability (min)	Degree of softening (FU)	Quality number
1	C-306	38.8	N, 20, 2+12	13.09	81.35	3.85	1.90	108	53.5
2	26-31	36.9	N, 20, 2+12	13.74	80.70	3.20	1.40	104	41.0
3	26-32	36.8	N, 20, 2+12	14.87	80.05	3.15	1.20	118	42.0
4	26-33	41.2	N, 20, 2+12	12.62	80.55	3.55	1.65	97	46.5
5	26-40	41.5	N, 20, 2+12	13.01	74.10	3.00	1.50	89	44.0
6	26-43	40.2	N, 20, 2+12	12.15	79.20	3.30	1.55	100.5	47.5
7	26-44	39.2	N, 20, 2+12	12.97	79.90	3.20	1.35	102	44.5
8	26-45	41.5	N, 20, 2+12	11.91	80.65	3.50	1.35	103.5	42.0

Values are means of two determinations on harvest of M_5 generation.

Quality analysis

The grain protein content of the parent was 13.1% while the range of protein content among the 23 mutant lines was 11.5 to 14.9%. Seven mutants selected for further analysis showed grain protein from 11.9-14.9%. The 23 mutants were analyzed using SDS-PAGE for their HMW-glutenin subunits. All the mutants except one showed HMWG subunit pattern which was similar to the parent (Null, 20, 2+12). Electropherogram of seven mutants and parent are shown in Fig. 2.

Rheological properties of dough

The seven mutant lines which were selected for studying dough properties showed that water absorption ranged from 74.1 to 80.7% as compared to 81.4% in case of C-306. The dough development time, dough stability, degree of softening and quality number were comparable to the parent (Table 1). Farinograph traces of the parent and two mutants are shown in Fig. 3.

Discussion

Mutation breeding has been applied to wheat for a variety of purposes [4, 6, 7]. Induced mutations have been shown to be useful in eliminating single defects in varieties which are otherwise useful. Obtaining a mutant that has all agronomic characteristics and having quality attributes of C-306 will be useful. In this experiment, the isolated early mutants showed anthesis in 50 to 61 days, which is as much as 25 days less than the parent variety C-306. The mutants matured in ~ 90 days

compared ~113 days for the parent. The parent variety, due to its late-flowering often matures when the temperature starts rising at the end of winter season. The early flowering and maturing mutants are expected to escape the adverse weather conditions.

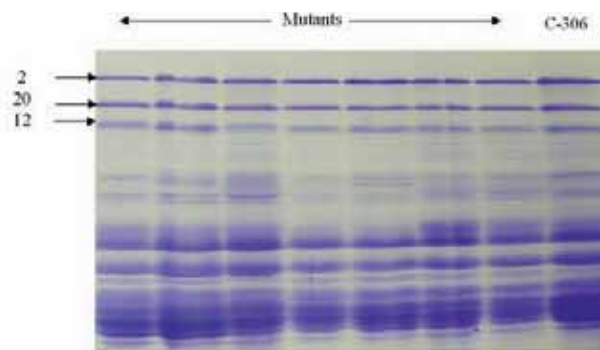

Figure 2 HMW-glutenin subunit patterns of parent and mutants as revealed by SDS-PAGE. L to R: lane 1-7: mutants, lane 8: C-306 (parent). The arrows indicate the presence of specific subunits.

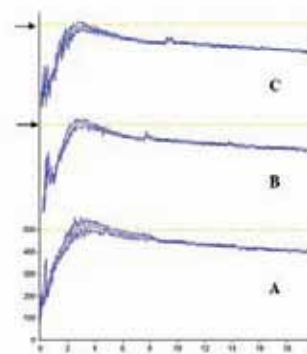

Figure 3 Farinograph traces of parent variety C-306 (A) and mutants 26-43 (B) and 26-44 (C). Arrow indicates 500 FU.

The mutants in the M_5 generation are expected to become more uniform in subsequent generations. The small differences in protein content and dough properties in the mutants and the parent could possibly be due to the difference in the conditions in which the grains developed and matured. The agronomic package for the mutants can be selected in such a way that its grain protein content and the dough properties would match the parent. Among the seven mutant lines, two mutants (26-43 and 26-44) were more comparable to the parent. These also were the highest in grain yield per line among the mutants, with 289.5 and 199.2g respectively. Their 1,000-kernel weights were numerically higher than the parent indicating increase in the grain size either due to genetics or to grain maturing in a favorable environment, or both.

The parent variety has hairy glumes; all the mutants used in the analysis showed plant morphology similar to the parent including hairy glumes. Some mutants with non-hairy glumes were observed. The early mutants isolated in this study are expected to retain good quality parameters and possess improved agronomic characteristics. The HMWG subunit '20' which is observed among the varieties with good *Chapati*-making quality, has not altered in the mutants. One mutant line was an exception and showed different subunit profile, the cause of which needs investigation. Grain protein quantity and quality influence the dough properties to a large extent and determine the quality of the end product. Since the mutants obtained in this study are comparable to parent variety C-306 in protein content and dough properties, they are expected to retain the *Chapati*-making quality.

The selected mutant lines will be evaluated in a replicated experiment to assess their yield potential.

ACKNOWLEDGEMENTS

We are thankful to Dr. S.F. D'Souza, Head, NA and BT Division for his encouragement during this research. We thank Shri Sudhakar Mali for technical assistance.

BIBLIOGRAPHY

- Mishra, B.K., Quality needs for Indian Traditional products. In: Nagarajan S, Singh G. and Tyagi B.S. (Eds.) Wheat Research Needs Beyond 2000 AD. Narosa Publishing House, New Delhi, 314-319 (1998).
- Mishra, B., Chatrath, R., Mohan, D., Saharan, M.S., Tyagi, B.S. DWR Perspective Plan: Vision 2025. Directorate of Wheat Research, Karnal, India, 14-15 (2007).
- Kundu, S., Nagarajan, S. Distinguishing characteristics of Indian wheat varieties. Directorate of Wheat Research, Karnal, India p.7 (1998).
- Chopra, V.L., Mutagenesis: Investigating the process and processing the outcome for crop improvement. *Current Science* **89**(2), 353-359 (2005).
- Bhagwat S.G., Bhatia, C.R. Selection for quality in early generation based on the HMW-subunits of glutenin in bread wheat. *Indian J. Genet.* **53** 208-214 (1993).
- Maluszynski, M., Szarejko, I., Maluszynska, J. Induced mutations in wheat. In: Bonjean A.P. and Angus W.J. (Eds.): The World Wheat Book- A History of Wheat Breeding. Lavoisier Publishing, 939-977 (2001).
- Boyd, L.A., Smith, P.H., Wilson, A.H., Minchin, P.A. Mutations in wheat showing altered field resistance to yellow and brown rust. *Genome* **45**, 1035-1040 (2002).

A Bentazon and Sulfonylurea-sensitive Mutant in Rice and its Application in Hybrid Rice

J Zhang^{1,*}, G Pan¹, X Wu² & J Tu¹

Abstract

A rice bentazon-lethal mutant 8077S obtained by radiation, is being utilized in developing new hybrid rice systems. Genetic analysis revealed that the bentazon-lethal mutant was controlled by a single recessive gene, which is named *bel*. The mutant can be killed at the seedling stage by bentazon with a lethal dosage at 300 mg/l or above, while this dosage is safe for its F₁ hybrids and all other normal rice. This mutant is also sensitive to all the tested sulfonylurea herbicides and this sensitivity is also controlled by *bel*. Interestingly, another rice bentazon-lethal mutant Norin8m also obtained by radiation in Japan, was controlled by the allelic locus of *bel*, which is named as *bsl*. These two mutant genes were cloned by map-based cloning. Both mutant alleles had a single-base deletion respectively. There is a G deletion in the *bel*. and a C deletion in the *bsl*. The wild-type gene *bel*. encodes a novel cytochrome P450 monooxygenase, named CYP81A6. Otherwise, the use of photo-thermogenic male sterility (P/TGMS) system in two-line hybrid rice breeding is affected greatly by the sterility instability of P/TGMS lines caused by temperature fluctuation beyond their critical temperatures for fertility reversion. To prevent the hybrid seed contamination, we have developed three bentazon-lethal P/TGMS lines using 8077S by backcross and three new hybrid rice varieties using these P/TGMS lines had been registered. When these P/TGMS lines selfed by temperature fluctuation, the seedlings from the selfed seeds can be killed by spraying bentazon at seedling stage but the hybrid seedlings are safety. These new hybrid rice varieties have been cultivated in five provinces in China.

Key words: Mutant, radiation, bentazon, hybrid rice, cytochrome P450.

Introduction

Bentazon is a selected contact herbicide classified to benzothiadiazole, and is used to control most broadleaf weeds and sedges in most gramineous and large-seeded leguminous crops. Normal rice is resistant to bentazon and it is harmless to use up to 6000 mg/L of bentazon during the whole development stage. This herbicide disrupts photosynthesis of the target plant by blocking electron transfer in photosystem II (G. Retzlaff and R. Hamm, 1976). Bentazon-lethal mutants Norin8m were obtained from Co⁶⁰- γ -radiated conventional japonica cultivar Norin8 by Mori K. Previous studies showed that Norin8m mutants had recessive inheritance, governed by a single locus (Mori K., 1984). This single locus was named *bsl*. and mapped on the long arm of chromosome 3 (Liu and Lu, 2004).

On the other hand, selective responses of plants to a chemical products can be used to identify a specific type of plant from a mixture, and thus this selective chemical can be exploited as a marker. Rice bentazon sensitive lethality mutation maybe used as a selective marker. For this purpose, we induced the indica thermo-sensitive genic male sterility

(TGMS) line W6154S by Co⁶⁰- γ -ray. A mutant 8077S which was sensitive to bentazon and sulfonylurea herbicides had been developed in this programme (Zhang J, *et al.*, 1999). Interestingly, these mutants also had recessive inheritance, governed by a single locus. This single locus was mapped on the long arm of chromosome 3 and named *bel*. (Zhang J, *et al.*, 2002). Then the *bel*. locus had been cloned by map-based cloning (G. Pan, *et al.* 2006).

In this paper, we summarized the agronomic characteristics and genetic pattern of the mutant 8077S and its applications in hybrid rice.

Obtaining of the bentazon-lethal mutant 8077S and its herbicides test

8077S was obtained through a mutation-breeding programme. Seeds from an indica TGMS line W6154S were treated with 350 Rad Co⁶⁰- γ -ray in 1995. The M₁ and M₂ plants were grown in the field with the temperature below the critical level required for fertility conversion of W6154S. M₃ plants were planted by families and some seeds from each M₂ plant were saved as seed sources since the sensitive mutant would be killed by herbicide. Six different herbicides including NC-311, bentazon, Londax, molinate, facet and Weinong, which are safe for the normal rice, were sprayed successively in the M₃ planting plot at one- to three-leaf stages. Recommended concentration rates for controlling weeds were used. Among 25,100 M₃ families tested, only one of them, numbered as 8077, was completely killed after spraying bentazon (Fig. 1), and this mutant was named 8077S.



Figure 1 The 8077S mutant from the M₃ families of radiated W6154S was planted in the field in 1997. The dead rice is 8077S.

To screen an herbicide to which M8077S is significantly sensitive, 29 herbicides belonging to 11 different chemical classes were tested using recommended rates for controlling weeds. The tested herbicides include bentazon and six sulfonylurea herbicides, i.e. Londax (bensulfuron), NC-311 (pyrazosulfuron), sulfometuron, metsulfuron, cinsulfuron, chlorsulfuron. The mutant 8077S and two controls including the original wild-type W6154S and a commercial cultivar Ce64-7, were used in this study. Among these herbicides, only bentazon selectively killed the seedlings of 8077S but was safe to W6154S (Fig. 2) and Ce64-7. 8077S was lethal to bentazon throughout the whole development stage. In addition, the mutant 8077S was also sensitive to all the tested sulfonylurea herbicides. The variety W6154S and the control variety had nearly normal

¹ College of Agriculture and Biotechnology, Zhejiang University, Hangzhou, 310029, China

² Institute of Food Crops, Hubei Academy of Agricultural Sciences, Wuhan, 430064, China

* Corresponding author. E-mail: zhjwen@yahoo.com

growth and development with the applied herbicides. For all other herbicides, 8077S had a normal response without any visible injury. There was no significant difference in responses to other herbicides between the mutant and the control varieties. Therefore, the mutant M8077S is selectively sensitive to herbicides bentazon and sulfonylureas.



Figure 2 8077S died but the original donor W6154S is safe seven days after spraying with 1,250 mg/l bentazon.

For the concentration test, 8077S and the other two controls were planted in the field and sprayed with Bentazon at the three-leaf stage with eight different concentrations: 20, 39, 78, 156, 313, 625, 2,500, and 5,000 mg/L. The concentration test for Londax was planned in pot experiments. Each pot was applied with 5ml of Londax. Four different concentrations, 3, 15, 30, 300mg/L (equivalent to 3, 15, 30, 300g/h in the field respectively), were tested. The results for the concentration test with bentazon indicated that 8077S could be killed in two to seven days after spraying when the concentration was higher than 300mg/L. However, the controls were not affected significantly even when concentration was up to 5000mg/L. The oncentration test with Londax indicated that when the concentration increased to 15mg/L, the mutant was severely injured. Ten days later, the mutant was only about half as tall as that of the controls. When concentration increased to 300mg/L, plant growth of the mutant was severely inhibited and seedlings died eventually. However, this concentration was still safe to the controls. Control varieties could keep normal growth and tillering although they showed some injury on their leaves with a color slightly darker than normal. This phenomenon was also observed in the field test (Fig. 3).



Figure 3 Ten days after spraying with 15g/h Londax in the field, the *bel*-tagged P/TGMS line (left) was severely injured, but the restorer line (middle) and the F_1 (right) are safe.

As a TGMS line, 8077S had an identical fertility conversion pattern and very similar agronomic traits as compared with its donor variety W6154S. When crossed with Ganhui 2, the mutant produced hybrids very similar to those produced with the original variety W6154S. This indicated that the *bel* gene did not have any significant effect on agronomic traits of the mutant and its hybrids except for bentazon sensitivity. 8077S also demonstrated other agronomic characteristics that the donor parent has including plant type, photo-thermo response, and combining ability.

Genetic patterns of the bentazon-lethal mutant 8077S

8077S was used as a female parent to cross with the original donor W6154S and five other indica varieties, Ganhui 2, Ce64-7, R1073,

R1074 and R6175. At three-leaf stage, all F_1 plants were sprayed with 1,250mg/L of Bentazon. Plants were then scored as normal and dead based on their reaction to the herbicide seven days after spraying. The results showed that all the F_1 plants were resistant to bentazon with concentration even up to 5000 mg/L. This indicates that bentazon sensitivity of the mutant is genetically recessive.

When four F_2 populations derived from crosses 8077S/Ce64-7, 8077S/R6175, 8077S/R1073 and 8077S/R1074, were treated with 1,250mg/L bentazon at three-leaf stage, numbers of dead and normal plants, scored seven days after spraying, fit very well with the 1:3 ratio, as expected for single-locus segregation. The genetic pattern for single genes was also confirmed by two F_3 families where numbers of killed families, segregating families and normal families fitted the ratio 1:2:1. So the single bentazon lethality locus was named *bel*.



Figure 4 3-D structures of *Bel*. (left), *bel*. (middle), and *bsl*.(right) proteins predicted using Swiss-model.

Bentazon-sensitivity and allelism test of the two mutants 8077S and Norin8m

The plants of 8077S and Norin8m mutants and their wild-type controls were treated with the following concentrations of bentazon: 0, 50, 100, 200, 300, 600, 1,250 and 5,800 mg/l. Three plants (15–20 tillers per plant) were used for each treatment at maximum tillering stage and scored in seven days after the treatment. The data confirmed that both 8077S and Norin8m plants started to show symptoms to bentazon at 100 mg/l and the lethal concentration was about 300 mg/l. The threshold concentrations of the bentazon sensitivity for the mutant plants were about 60-fold lower than those for their wild-type controls. In addition, both 8077S and Norin8m plants were also sensitive to sulfonylurea herbicides.

Although *bel* for 8077S and *bsl* for Norin8m were shown to be located on chromosome 3, it was not clear whether they represented the same or different genes. To address this question, a cross was made between these two mutants. Thirteen F_1 and 800 F_2 progeny plants, along with their original parents, were treated with 1,250 mg/l bentazon at maximum tillering stage. The results showed that in contrast to the healthy plants prior to treatment, the parents, 13 F_1 , and 800 F_2 progeny plants all died in seven days following the treatment, suggesting that *bel* and *bsl* were allelic.

Molecular mechanism of the bentazon-lethal mutants

Using primary gene mapping, 91 recessive susceptible individuals were selected from an F_2 mapping population developed from the cross between 8077S and P64S, showed that the *bel* was determined to be on the long arm of chromosome 3 and was linked to RM168 at a distance of 7.1cM. To gain information on the exact location of *bel*, 231 recessive susceptible individuals were selected from an F_2 mapping population developed from a cross between PA64Sm and 93-11 for fine mapping. The level of SSR polymorphism between them was highest among the parents tested. The detected polymorphic markers 3a, 7a, 8a, 14a in the genomic region from RM416 to RM3867 were used to survey these 231 recessive susceptible individuals. The data confirmed that the *bel* locus was located between the markers RM416-8a-3a and 7a-14a-RM3867.

The map distances between the *bel* and two closely linked markers of 3a and 7a were 0.1 and 0.4 cM, respectively. The markers 3a and 7a were found to be on the same BAC clone (AC084282) and the physical distance between the markers was 110 kb.

Further genomic analysis revealed that this 110kb sequence contains 25 putative genes, including a cluster of four tandem cytochrome P450 genes, namely CYP81A5, CYP81A6, CYP81A7 and CYP81A8 (GenBank Accession No: AAK63940.1, AAK63920.1, AAK63922.1 and AAK63925.1, individually). Considering that cytochrome P450s are ubiquitous heme proteins and known to play an important role in detoxification of natural and synthetic xenobiotics such as herbicides, we therefore treated those four cytochrome P450 genes as the primary candidates for the wild *Bel* gene.

To further address which gene among the four candidates corresponds to the *bel/bsl* locus present in 8077S and Norin8m, we comparably sequenced the PCR products of four genes amplified from 8077S and Norin8m and their wild type progenitors 8077S and W6154S. It was observed that among the four genes, CYP81A6 from 8077S was the only one that had a single-base deletion of G at 1,332th nucleotide of its coding sequence compared to W6154S. In order to verify this deletion mutation, we also amplified and sequenced the fragments flanking the mutation site from two *bel*-tagged *indica* lines 03B198 and 03B199 and two *indica* normal maintainer lines Minghui63 and 93-11, and identical results were obtained. For Norin8m, among the four genes only a single-base deletion of C was also detected in the coding region of CYP81A6 was observed in comparison to Norin8. These results suggested that the CYP81A6 gene might be the *Bel* locus.

Based on the above results, we isolated the genomic fragment of the CYP81A6 gene through PCR amplification. The total length of *Bel* is about 4 kb. The *Bel* gene contains a coding region of 1,542bp interrupted by an intron of 618bp.

The deleted base at *bel* is G that occurred at exon 2 and that at *bsl* is C that happened at exon 1. In genetics, any single base deletion can cause reading-frame shift on the subsequent sequence and creation of one or more termination codons before the native one, which leads to premature termination of translation. Both these alternations may have the effects on the mutation phenotype but which one is dominant depends on where the mutation site is located and where the effective termination codon is created. In case of *bel* protein, the premature termination caused the removal of 46 amino acid residues in the downstream part. This removal is exclusive of any important functional domain as presence in *Bel* and its mutation effect might thus be very limited. What the reading-frame shift altered, however, is the heme-binding motif (from FGMGRRRCPG₄ to FGMGGGGGAPA₄), in which a key amino acid residue of cysteine has been characterized as the fifth ligand to the heme iron and is strictly conserved nearly for all of the known P450 genes. Changing of this key amino acid is hence speculated to be the main reason for loss of function of *bel*. In case of *bsl* protein, only 225-aa residues are reserved, resulting in the removal of several conservative domains such as the E-R-R triad involved in the heme pocket locking, the I-helix responsible for oxygen activation, and the heme-binding domain. This longer polypeptide truncation is much likely the main reason for loss of function of *bsl*.

Furthermore, in the herbicide test, we observed that, the *bel* mutant was slightly more tolerant to bentazon than the *bsl* mutant. This result not only shows the existence of a correlation between the bentazon sensitivity and the truncated polypeptides length but also implies that the modified heme-binding domain with C to G substitution presence in the *bel* protein might still keep a partial function in the activity to bind to heme iron. **Figure 4** shows the 3-D structures of *Bel*, *bel*, and *bsl* proteins predicted using Swiss-model (Schwede T, *et al.* 2003). The comparison made between these 3-D structures provides the evidences that the truncated *bel* protein has the basic global structure as that of the wild *Bel* protein except two β -folder is removed from C-terminal

and the modified heme-binding domain with C to G substitution is still toward the activation groove of the protein, a condition for this domain to play roles if available. However, more data is needed to confirm these deductions.

Application to secure purity in hybrid rice production

One of the most important applications of the *bel* gene in hybrid rice is to maintain hybrid purity. The two-line hybrid rice based the photo-thermo-sensitive genic male sterility (P/TGMS) have been broadly planted in China. However, most P/TGMS lines require a specific temperature (usually higher than a critical temperature) to maintain their sterility. Abnormal weather could bring the temperature down below the critical temperature that is required for conversion of P/TGMS lines from sterility to fertility, or simply called fertility conversion, which makes P/TGMS lines fertile or partially fertile in the location where they are supposed to be sterile in normal years. This results in a potential problem for seed production of two-line hybrid rice, i.e. a P/TGMS line producing seeds either from outcrossing as required for seed production or from selfing. The mixture of real hybrids with selfed seeds from the P/TGMS line cannot be used, resulting in a great loss to seed producers or to rice producers once false hybrid seeds are used in rice production. As insurance to the seed production, marking the P/TGMS lines using *bel*, named bentazon-lethal P/TGMS lines, could help remove the false hybrids from the mixture. If the hybrid rice seeds were contaminated with the selfed seeds of these bentazon-lethal P/TGMS lines, we sprayed bentazon at the seedling stage to selectively kill the seedlings from the selfed seeds of the P/TGMS lines. Then the hybrid rice purity in the field is insured.



Figure 5 After spraying with 1,250 mg/l bentazon, the *bel*-tagged P/TGMS line “Ben63S” (middle) died, but the restorer line “1175” (right) and the hybrid rice “Benliangyou639” F₁ (left) are safe.

The *Bel* gene can be also used for purity test in seed production. Hybrid rice seeds must be tested for purity before release to rice producers. Traditionally, seed samples are planted, and then a waiting period until they flower ensues, so they can be told from the false hybrid plants based on distinct agronomic traits. In order to obtain purity test results before the next planting season, seed samples are usually sent to a location where rice can be planted in the winter like Hainan, China. However, this is labor-intensive and also very expensive. Using bentazon sensitivity, false hybrids can be told by killing at two to three-leaf stages. A seedling tray in a greenhouse or in an incubator will be enough for a purity test required for any sample of hybrid seeds.

The technique for the use of the *bel* gene in seed purity management has been developed in our breeding programme. In the past decade, we have developed three bentazon-lethal P/TGMS lines (M8064S, B88S, B63S) using 8077S by backcross and three new hybrid rice varieties using these P/TGMS lines had been registered (Fengliangyou No 2, Benliangyou 639, and Benliangyou No 9) (**Fig. 5 and 6**). Now these hybrids have been broadly planted in Hubei, Guangxi, Jiangxi, Hunan and Anhui provinces in China.

Development of chemically induced male sterility in hybrid rice

Previous study showed that the expression of the *Bel* gene was constitutive expression, and W6154S transformants with the antisense displayed the bentazon- and sulfonyleurea-sensitive phenotype similar to 8077S (Fig. 7). We may develop a novel herbicide-emasculum male sterile system by the antisense or RNAi of the *Bel* gene. In order to create the herbicide-emasculum male sterility line, the antisense or RNAi fragment of the *Bel* gene under the control of the tapetum-specific promoter such as the *Osg6B* has been constructed and introduced into the normal rice by *Agrobacterium*-mediated transformation, the tapetum of the transgenic rice was sensitive to the sulfonyleurea and the other tissue of the plant resistance to the sulfonyleurea, so that the transformants will be male sterile after spraying sulfonyleurea herbicide (no published data).



Figure 6 The *bel*-tagged hybrid rice cultivar "Benliangyou No 9".



Figure 7 After spraying with 1,250 mg/l bentazon, the 8077S(left) and the W6154S transformants with the antisense of the *Bel* gene (middle) died, but the original W6154S was safe.

ACKNOWLEDGEMENTS

We gratefully acknowledge financial support from China Natural Science Foundation (39570469, 39970446, 30370873, 30700498), the Hi-Tech Research and Development Programme of China (2007AA10Z126), the China Postdoctoral Science Foundation, and Hubei Changjiang Tunyu Seed Company Ltd. Thanks are also to Dr. Yunbi Xu and Professor Lihuang Zhu for their valuable advice during this research.

BIBLIOGRAPHY

1. Pan, G., Zhang, X., Liu, K., Zhang, J., Wu, X., Zhu, J., Tu, J. Map-based cloning of a novel rice cytochrome P450 gene CYP81A6 that confers resistance to two different classes of herbicides. *Plant Mol Biol* **61**, 933-943 (2006).
2. Retzlaff, G., Hamm, R. The relationship between CO₂ assimilation and the metabolism of bentazone in wheat plants. *Weed Research*. **16**, 263-266 (1976)
3. Liu, Q., Lu, Z. Molecular mapping for bentazon susceptible lethality gene in rice cultivar *Nonglinum*. *J Njing Agric Univ* **27**, 17-19 (2004).
4. Mori, K. Inheritance of susceptible mutant in rice plant to herbicide bentazon. *Jpn J Breed* **34**(1), 421-422 (1984).
5. Schwede, T., Kopp, J., Guex, N., Peitsch, M.C. SWISS-MODEL: an automated protein homology-modeling server. *Nucleic Acids Research* **31**, 3381-3385 (2003).
6. Zhang, J., Wu, X. Screening and preliminary study on the chemical lethal mutant in rice photoperiod-temperature sensitive male sterile line. *Chinese J Rice Sci* **13**, 65-68 (1999).
7. Zhang J., Xu Y., Wu X., Zhu L. A bentazon and sulfonyleurea sensitive mutant: breeding, genetics and potential application in seed production of hybrid rice. *Theor Appl Genet* **105**, 16-22 (2002).

Dwarf Male-Sterile Wheat: A Revolutionary Breeding Approach to Wheat

L Yang*, B H Liu, H Q Zhai, S H Wang, H W Liu, Y Zhou, F H Meng, J P Yang, G Zhu, S L Chui, Q H Zhang & Y L Wei

Abstract

Dwarf male-sterile wheat is a new germplasm that linked the Taigu genic male-sterile gene *Ms2* with *Aibian1* dwarfing gene *Rht10* tightly on the same chromosome 4DS with 0.18 crossing-over unit. The progeny of dwarf male-sterile wheat always segregates into 1:1 for male-sterile plants with dwarfing gene *Rht10* and male-fertile plants without dwarfing gene *Rht10*. So the male-sterile plants are shorter than the male-fertile plants. It is very easy to identify male sterility plants based on plant height. Dwarf male-sterile wheat is favorable tool for wheat breeding in recurrent selection. A simple, effective and practical method in recurrent selection called the dwarf male-sterile wheat breeding system has been created. The new dwarf male-sterile wheat technical system consists of construction of a basic population, choice of male parent, selection of male-sterile plant and inter-crossing. Four new cultivars, i.e. RS981, RS987, RS518 and RS201 have been developed. Dwarf male-sterile wheat and its breeding technical system is an effective technology platform for wheat breeding in different ecological areas.

Introduction

Since Mendel's Law was re-discovered, wheat breeders, as well as breeders of other crops, started making use of genealogical selection via sexual hybridization to cultivate new wheat varieties. During the last hundred years, countless numbers of wheat-improved varieties have been produced that have helped solve difficult agricultural situations. The world wheat grain yields have been increasing substantially, especially in 1960s and 1970s, the semi-dwarfing high-yielding varieties and cultivation methods of the so-called "green revolution" were adopted worldwide [1].

But the genealogical selection has less and less effect on the progress of wheat genetic improvement since the 1980s. One reason is that genealogical selection limits the recombination and possibility of selection of favorable genes. Another reason is that this selection method just uses several varieties to do crosses and relates to the narrow genetic base of the developed varieties.

Recurrent selection (RS), firstly applied in cross-pollinating maize, is a population improvement method that increases the frequency of favorable alleles while maintaining genetic variation in the breeding population. The scale of manual crossing tampers with the effect of recurrent selection in self-pollinating wheat. One solution for this is to use male-sterile mutants instead of manual crossing in wheat recurrent selection. There are three important male-sterile genes that have been found in wheat. Driscoll (1978) described the production and use of a recessive male-sterility-inducing form of chromosome 4A which he designated "Cornerstone (*ms1*) in wheat breeding. One primary disadvantage of *ms1* is that the amount of sterile plants is not always sufficient for recombination in wheat current selection [2]. *Ms3* is a dominant gene for male sterility found after EMS (ethyl methane sulfonate) treatment

of the seeds of an alloplasmic common wheat with *Aegilops squarrosa* cytoplasm [3].

In 1972, a genic male-sterile form of common wheat was found at Taigu County, Shanxi Province, China, and it has been shown that the sterility controlled by a single dominant gene (designated *Ms2*). *Ms2* was located on the short arm of chromosome 4D with 31.16 centimorgan (cM) to the centromere [4,5,6]. During the past 30 years, *Ms2* has been introduced into a thousand backgrounds of Chinese varieties, even including octoploid triticale, and no self-fruitful seed has been found among them.

Chinese wheat breeders popularly adopt *Ms2* as a tool in wheat recurrent selection. However, two main shortcomings of *Ms2* have been found during its applications. One is that there is no difference of plant height between sterile plants and fertile ones. Therefore, many efforts must be made to identify plant sterility when flowering in the field. Another is that male-sterile plants easily get pollens from higher plants above. So the average height of recurrent population gets higher and higher with selection cycles.

Creation of dwarfing male sterile wheat

Chinese wheat breeders took into consideration the use of a trait to label *Ms2*. One of the most important short wheat germplasm resources, Ai-bian 1 (25.5 cm), was found in Shanxi Province, China. It is the shortest wheat in the world controlled by the dominant gene *Rht10*. It was also located on the short arm of chromosome 4D with almost 50 cM to the centromere [7]. The data showed that there were almost 20 cM between *Ms2* and *Rht10*. Could *Rht10* be used as a marker of *Ms2*? The re-test results showed the genetic distance of *Rht10* to the centromere was 31.17 cM instead of 50 cM [8]. It means that *Ms2* and *Rht10* should be linked closely.

In order to obtain the new recombination of *Ms2* linked with *Rht10*, the male-sterile Chinese Spring (about 108 cm) was pollinated with the dwarfing Ai-bian 1 (about 25.5 cm). All F1 hybrids were dwarfing phenotypes (about 48 cm), with one half of sterile plants and one half of fertile plants. The F1 dwarfing male-sterile plants were crossed back to double recessive, tall and fertile Chinese Spring. During 1984-1986, no recombination types were found among 321 recovered plants from the testcrosses. During 1986-1988, the population of the progeny was increased, of the 5,216 recovered plants from the testcrosses, 33 plants showed new phenotypes: one dwarfing sterile plant and 32 tall fertile plants, 2,632 and 2,551 plants showed tall sterile and dwarfing fertile, respectively. The material carrying *Ms2* for male sterility closely linked with *Rht10* for dwarfishness was named Dwarfing Male-Sterile Wheat [8].

During 1989-1990, to test the genetic distance between *Ms2* and *Rht10*, we crossed Dwarfing Male-Sterile Wheat (*Ms2Rht10/ms2rht10*) with the variety Fengkang 13 (*ms2rht10/ms2rht10*). The progeny of this cross had 1,874 dwarf sterile plants (*Ms2Rht10/ms2rht10*), 2,036 tall fertile plants (*ms2rht10/ms2rht10*), two dwarf fertile plants (*ms2Rht10/ms2rht10*), and five tall sterile plants (*Ms2rht10/ms2rht10*). Of all the

The National Key Facility for Crop Gene Resources and Genetic Improvement Institute of Crop Science, Chinese Academy of Agricultural Sciences Beijing 100081, China

* Corresponding author. E-mail: yangli@mail.caas.net.cn

1,917 plants, seven of the recombination genotypes gave 0.18 cm of linkage value between *Ms2* and *Rht10*. It is an amazing thing that both perfect dominant genes link with each other so tightly.



Figure 1 Dwarfing male sterility wheat and male fertility wheat.

Main characteristics of dwarfing male sterile wheat

Dwarfing male sterile wheat keeps all the advantages and abandons all the shortcomings of both of its parents, Taigu genic male sterile wheat and Ai-bian 1. (1) Dwarfing male sterile wheat has some characteristics of both the self-pollinating plant and the cross-pollinating one. It can be easily pollinated with any other wheat varieties or lines, and their offspring will segregate 50% dwarfing male-sterile plants and 50% normal fertile ones. Free cross-pollination of the dwarfing male-sterile plants leads to the interchange and recombination of favorable genes; and self-pollination of the normal fertile plants facilitates the homozygote and stability of favorable genes. (2) The plant male-sterility can be easily identified according to plant height in the early spring. Wheat breeders have enough time to design their plans to do crosses and to remove the inferior plants. (3) The plant height of the recurrent population can be easily controlled. The Dwarfing Male-Sterile Wheat can adequately and freely get the pollens from the fertile plants around. So the possibility of selecting favorable genes increases. (4) By means of dwarfing male sterile wheat, manual crossing is no longer a limit in wheat breeding. Many crosses can be used as breeding targets, so dwarfing male sterile wheat is a perfect tool for wheat breeding, especially for wheat recurrent selection.

During our effort over the past ten years, a new technical system of wheat recurrent selection and different wheat improved populations by means of dwarfing male sterile wheat were established in our institute. In the improved populations, yield potential, grain quality, lodging resistance and disease resistance have increased on a large scale. Many new varieties or lines with general good agronomic traits have been developed from these improved populations. Nobel laureate Dr. Norman Borlaug, father of Green Revolution, stated that the dwarfing male sterile wheat is “a revolution in wheat breeding.”

Application effects of dwarfing male sterile wheat

Using dwarfing male-sterile wheat in recurrent selection, we have created a simple, effective and practical method and technology. The characteristics of the improved population, such as yield, quality, resistance and plant-type have increased more rapidly. We have selected four new cultivars, RS981 (Recurrent Selection), RS987, RS201 and RS209 and a series of new lines. Dwarfing male-sterile wheat and its breeding technology system are a technology terrace for wheat breeding in differ-

ent ecological area. Recurrent selection by using dwarfing male-sterile wheat will lead to a revolution in the wheat breeding method.

Simple and effective recurrent selection technology in wheat breeding

Through several years practice in wheat breeding, we have developed a convenient, practical and relative quantitative recurrent selection technology system and method. Population of per cycle consists of seeds from dwarfing male sterility plants. According to our studies, dwarfing male sterility trait and pollen quality accepted by dwarfing male sterility plants are role important for recurrent selection. We have created a multi-selection technology on dwarfing male sterility plant selection, developed pollen resource selecting technology and controlled technology on the cross-pollinated.

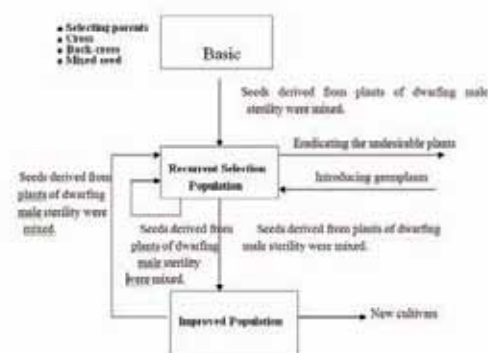

Figure 2 Procedure and method of recurrent selection breeding using dwarfing male sterility wheat.

Genetic diversity enhancement in the improved population

Through 10 years recurrent selection and intercross using dwarfing male-sterile wheat, the population of dwarfing male-sterile wheat has improved effectively. In improved population of dwarfing male-sterile wheat, characteristics such as yield potential, grain quality, lodging resistance, and disease resistance, have increased on a large scale. Many different kinds of male fertility plants with good agronomic traits were segregated in an improved population. Using dwarfing male-sterile wheat of Beijing of China as a basis population crossed with parents' material that adapt to different ecological regions, improved population of breeding goals will be established rapidly.

Achievements in new variety development

In the China National New Wheat Cultivars Demonstration Experiment in 2003, the new variety RS987, RS981, RS201, RS209 and RS981 that derived from dwarfing male-sterile wheat improved population were NO.1, NO.2, NO.3, NO.6 and NO.8 in order of yield increase respectively.

RS987 is a high-yielding wheat cultivar. In later years, the yield of RS987 was NO.1 in all yield trials such as the National Northern Winter Wheat Yield Trial, New Cultivars Demonstration Experiment and Production Registered Trial. The yield is significantly greater than that of check cultivar. RS987 was registered by China National Crops Cultivars Register Commission in 2003.

Conclusions

Dwarfing male sterile wheat and its technical system in recurrent selection has been popularized by more than 40 institutions of wheat breeding in China.

BIBLIOGRAPHY

1. Peng *et al.* Rht Gene for Green Revolution in Wheat and Gibberellin Signal Conduction. *Review of China Agricultural Science and Technology* **3**, 62 (1999).
2. Driscooll, C.J. Induction and use of the "Cornerst one" male-sterility in wheat. *Proc. 5th Int. Wheat Genet. Symp.*, 499-502 (1978).
3. Maan, S.S. *et al.* Chromosome arm location and gene centromere distance of a dominant gene for male sterility in wheat, *Crop Sci.* **27**, 494-500 (1987).
4. Deng J.Y., Gao Zhong L.I. Discovery and identification of dominant male sterile gene in wheat. *Acta Agro Sin* **6**(2), 84-98 (1980).
5. Wang Linqing *et al.* Study on dominant male sterile gene"2-2-3" in wheat. *Science Agricultura Sinica* **3**, 1-7 (1980).
6. Liu Binghua *et al.* A dominant gene for male sterility in wheat. *Plant Breeding* **97**, 204-209 (1986).
7. Izumi N. *et al.* Genetic analysis of dwarfness in *Triticum aestivum* L. *Ai bian* **1**, 31, 38-48 (1983).
8. Liu Binghua, Y. Breeding of Dwarf and male sterility wheat. *Science Aviso* **36**(4), 306-307 (1991).
9. Liu Binghua.,Y. A bortive Dwarf Wheat and Its Application to Breeding for Dwarfness. *Agricultural Science in Chian*, 22-26 (1997).

Induced Mutations for Development of *B. Juncea* Canola Quality Varieties Suitable for Indian Agro-climatic Conditions

Y Y Barve¹, R K Gupta¹, S S Bhadauria¹, R P Thakre² & S E Pawar²

Abstract

Dry and presoaked canola quality 'Heera' seeds were treated with 0.01, 0.02 and 0.03% EMS with three and six-hour mutagenic treatments. Five mutants with early maturity (93-95 days) as opposed to 140 days of the parent were evaluated in trials. EH-1 was found superior in yield potential; however, the yield was lower than the control. Several selections with low glucosinolate, high erucic acid and canola quality were identified from the cross, mutant EH-1 and NU-6 (mutant derivative). Selection NUDH-YJ-6 with low glucosinolate, high erucic acid, 3.6g test weight and high oil content (46%) was at par in seed yield but 17% higher in oil yield in the multi-location trials of four years during 2003-04 to 2006-07 at 10 locations in zone III and zone IV of India. The advance selection derived from EH1 × NU6 was crossed with large seed mutant PB7. Several '00' selections were developed and studied for their agronomic characters. Two selections along with checks were evaluated for two years during 2005-06 and 2006-07. Both these selections were resistant to white rust disease and gave seed and oil yield comparable to national check Varuna. Another selection NUD-YJ- 5 with canola characters of maturity like Indian mustard varieties with small seed size has been registered with the National Bureau of Plant Genetic Resources (INGR NO-03034), ICAR, New Delhi.

Introduction

In India, nine annual oil seeds are cultivated on 30.25 million hectares with a production of 25.3 million tons and productivity of 1,067Kg/ha. Out of these, rapeseed mustard is second most important group of oil seed crops in India after groundnut and is being cultivated on 7.3 million hectare, with a production of 7.6 million tons. Per capita consumption of oil in India is increasing day by day and it is therefore imperative to have maximum productivity of oil crops. Mustard oil has characteristic pungency due to presence of glucosinolates in the seed meal and high erucic acid in oil, which renders mustard oil as less preferred over other cooking oils. None of the released varieties in India have the desired quality characters. Erucic acid content in the Indian cultivars is high averaging 49% compared to 25% in the European cultivars. The amount of glucosinolate varies from 150-240 µmole/g of defatted meal. Earlier Khalatkar, *et al* [1] had indicated high effectiveness of gamma radiations and EMS in the induction of mutations in genes controlling the synthesis of erucic acid and glucosinolates. Besides classical breeding, mutation breeding has demonstrated the plasticity of seed oil quality with significant alteration in fatty acid composition and no apparent detrimental effects on the crop agronomics [2] [3]. Larger seed size is one of the important yield-contributing traits in all of the crops. Improvement in seed size has been achieved through induced mutations in several crops. Pawar, *et al* [4] and Bhatia, *et al* [5] have demonstrated increase in seed size up to 25% in Pigeonpea and black gram by radiation induced mutation

and recombinant breeding. The development of high value mustard oil having 30-40% oleic acid, less than 2% erucic acid, coupled with significant reduction in glucosinolate in the meal is the prime objective of this investigation. Both induced mutation and recombination breeding approaches were adopted in the present investigation for developing high yielding varieties of *B. juncea* with canola quality, yellow seed coat and white rust resistance.

Materials and Methods

The mutation breeding/hybridization programme was initiated during 1994-95 for developing canola quality early-maturing varieties with high yield potential. The canola quality 'Heera,' yellow seeded and white rust resistant *B. juncea* selection was developed at the Department of Botany, RTM Nagpur University, Nagpur, India by the late Dr. A. S. Khalatkar during 1992-93. It was late in maturity and not suitable for commercial cultivation in Indian conditions. It has been registered with the National Bureau of Plant Genetic Resources (INGR NO-03033), ICAR, New Delhi as a canola genotype developed in India. Heera seeds were water presoaked for 12 hours and treated with 0.01, 0.02 and 0.03% EMS with three and six-hour mutagenic treatments. Five mutants with early maturity (93-95 days) as opposed to 140 days of the parent were identified. They were dwarf, small-seeded with yellow seed coat.

NU-6 was selected in the segregating generation of EH-1 × Pusa Bold with high erucic acid and medium glucosinolate (30-40 µmole/g of seed) with medium seed size (4g test weight). In another experiment, the mutagenic treatment of 0.04% Sodium Azide was given to 12-hour water soaked seeds of advanced selection derived from cross EH1 × Pusa Bold. The mutant PB-7 with large seed size (5.5g test weight), zero erucic acid, medium glucosinolate (30-40 µmole/g of seed) was identified in the M₂ generation.

An extensive hybridization programme using mutants EH-1 and PB7 and mutant derivative NU-6 was initiated for the development of agronomically suitable canola quality selections with high yield potential. Several selections with low glucosinolate, high erucic acid and canola quality were identified from the cross EH-1 × NU-6 and tested in multi-location trials. In another programme, mutant PB-7 was crossed with advanced derivatives of EH1 × NU6 having canola characteristics. In the segregating population, several '00' selections were developed and studied for their agronomic characters. Two selections along with checks were evaluated for two years during 2005-06 and 2006-07, and the yield performance is reported in the present communication.

Results and Discussion

Development of early mutants of Heera

Induction of early flowering / maturity is one of the most frequent characters modified in the mutation experiments in all the crops. In oil seed Brassica crops, several early flowering/maturity have been reported [6]. The mutation breeding programme was initiated for inducing early maturity in Heera. Five early flowering dwarf mutants (EH-1 to EH-5) were obtained in M₂. These mutants matured in 93 to 99 days as

¹ Dhara Vegetable Oil & Foods Co. Ltd. NDDB Campus, Anand 388001 India

² Department of Botany, RTM Nagpur University campus, Amravati Road, Nagpur - 440033 India

* Corresponding author. Email: yoganandbarve@gmail.com

compared to 140 days that of control Heera (Table 1). They were dwarf, yellow seeded, and white rust resistant with canola characteristics. These were evaluated in multi-location trials but could not surpass the yields of non-quality variety Varuna. Among these, EH-1 was found to be superior in yield potential (Table 2).

Table 1 : Yield performance of EH selections at Nagpur

Mutant	Treatment	Days to maturity	Plant height (cm)	Yield (Kg/ha)
EH-1	12PSW + 3hrs EMS - 0.02%	93	175	1682
EH-2	12PSW + 6hrs EMS - 0.01%	95	177	1297
EH-3	12PSW + 3hrs EMS - 0.03%	97	165	1342
EH-4	12PSW + 3hrs EMS - 0.02%	93	169	1040
EH-5	12PSW + 3hrs EMS - 0.02%	99	166	1336
Heera	Control	140	202	1098

Table 2. Yield performance of EH selections in multi-location trial during 1997-98

Selection	Seed Yield (Kg/ha)					Mean
	Allahabad	New Delhi	Ropar	Mehsana	Nagpur	
EH-1	673.37	1416.67	411.38	895.83	244.40	728.33
EH-2	653.36	1576.39	282.09	867.42	208.11	717.47
Varuna (C)	1133.39	1000.00	634.70	1777.15	838.80	1076.81

Indian varieties are brown colored and have a higher fiber content, which is undesirable for animal nutrition. Genotypes with yellow seed color having low fiber content can also be used as genetic marker for '00' brassicas. Indian mustard high-yielding varieties are white rust susceptible and in traditional areas approximately 25% loss in the yields has been observed. Recombination breeding approaches have resulted in the development of 667 new crop varieties out of 2,252 mutant varieties worldwide [7]. In the present investigation emphasis has been given to developing yellow seeded, white rust resistant, large seed sized, canola quality genotypes using recombination breeding approaches.

Seed size improvement of early mutants

High-yielding mutant EH-1 was crossed with popular non-canola quality variety Pusa Bold with large seed size (5.5g /1000 seed). In the segregating population NU-6 was identified with high erucic acid and medium glucosinolate (30-40 μ mole/g defatted meal). The seed size of NU-6 was 4g/1000 seed.

In another programme, advance selection in the F_4 generation from the cross EH-1 \times Pusa Bold was treated with 0.04% sodium azide and in the M_2 generation, 47 plants were selected having zero erucic acid and medium glucosinolate. In the M_3 generation, 12 plants were selected on the basis of zero erucic acid, medium glucosinolate and good plant type. In the M_4 generation, one plant with same quality character and extra large seed size (5.5g/1000 seed) was isolated. The mutant PB-7 was studied for its breeding behavior and was stabilized in the M_6 generation. This mutant was extensively used in further crossing programme for the development of bold seeded, double low, high-yielding selections.

Development of high-yielding, high-oil containing selections

Extensive hybridization was carried out with EH-1 and NU-6 as parents, and several single and double low selections were identified. Out of them, one selection NUDH-YJ-6, with high erucic acid and low glucosinolate quality, high oil content (46%) and 3.6g/1000 seeds was identified. Due to its high oil content, it was evaluated first in station trial and then in multi-location trial in zone III and IV for three consecutive

years from 2003-04 to 2006-7. Though the seed yield was at par with the national check over the period and locations during the trial, the selection NUDH-YJ-6 gave 16% higher oil yield than the national check (Table 3).

Table 3. Mean yield performance and quality of '0' selection in multi-location trial during 2003-04 to 2006-07 in zones III and IV of India (10 locations)

Variety	Erucic Acid (%)	Glucosinolate (μ mole/g seed)	TW (g)	Oil content (%)	Mean seed yield (Kg/ha)	% increase	Mean oil yield (Kg/ha)	% increase
NUDH-YJ-6	49.5	7.0	3.6	46	1950	4.3	897	17.0
Varuna (C)	46	110.8	4.2	41	1869	0.0	766	0.0

Mustard oil is not preferred in central and southern India due to its pungency. Low glucosinolate selection NUDH-YJ-6 having 16% higher oil yield over the national checks certainly will help to increase the area under the non-traditional ecosystem thus making the alternate oil available for people of the region. The seed meal having low glucosinolate content will be ideal as cattle and bird feed.

Development of canola quality genotype

Selection NUDH-YJ-5, derived from the cross EH-1 \times NU-6 with canola quality, yellow seed coat, small seed size (3g/1000 seed) and maturity like Indian mustard varieties was developed. It was also resistant to white rust disease. NUDH-YJ-5 has been registered with National Bureau of Plant Genetic Resources (INGR NO-03034), ICAR, New Delhi as canola genotype suitable for Indian agroclimatic conditions. This selection also could not surpass the yield of national checks in the trials.

In order to increase the seed size of canola quality selections, mutant PB-7 was crossed with the derivative of (EH1 \times NU6). In F_6 , two selections viz. 1A/5-5-1-5 and 1A/5-23-29-18 were identified as having true breeding behavior in quality characters, disease resistance and genetic purity. Both these selections had shown promising yield potential and thus were evaluated in multi-location trial for two years in zone III and IV of Indian agroclimatic conditions (Table 4).

Table 4. Performance of '00' selections in multi-location trial during 2005-06 to 2006-07 in zones III and IV (six locations)

Variety	Erucic Acid (%)	Glucosinolate (μ mole/g seed)	TW (g)	Oil content (%)	Mean seed yield (Kg/ha)	% increase	Mean oil yield (Kg/ha)	% increase
1A/5-5-1-5	0	17.0	3.3	42	2053	1.6	862.26	4.1
1A/5-23-29-18	0	10.0	3.6	41	2000	-1.0	820.00	-1.0
Varuna (C)	46	110.8	4.2	41	1869	0.0	828.2	0.0

Conclusion

The yield potentials of NUDH-YJ-6 having low glucosinolate, high erucic acid and significantly higher oil content (46%) was comparable with Indian popular varieties, however, it gave 17% higher oil yield. Canola quality selections 1A/5-5-1-5 and 1A/5-23-29-18 were comparable in yield with national checks. Seed size improvement could not be achieved in this programme. Research efforts are being made to improve the seed size of these selections.

ACKNOWLEDGEMENTS

We are thankful to National Dairy Development Board, Anand, and its wholly owned subsidiary M/s Dhara Vegetable Oil & Foods Co. Ltd. Anand (Gujarat) India for financial support for the present investigation.

BIBLIOGRAPHY

1. Khalatkar, A.S., Indurkar, H.S. Mutations for double zero Brassica juncea. (Proc. GCIRC Eighth International Rapeseed Congress) Saskatoon, Saskatchewan, Canada. 1549-1554 (1991).
2. Bhatia, C.R. *et al.* Use of induced mutations in the breeding of pulse crops. In: Proc. IAEA Symp. On Plant Mutation Breeding for Crop Improvement. June 18-22, 1990 Vol. II. IAEA. Vienna, p.43-53 (1991).
3. Bhatia, C.R. *et al.* Oil seed cultivars developed from induced mutations altering fatty acid composition. *Mutation Breeding Review* **11**, 1-36 (1999).
4. Maluszynski M. *et al.* Officially released mutant varieties- the FAO/IAEA data base. *Mutation breeding review* **12**, 1-84 (2000).
5. Nichterlein K. *et al.* Achievements and trends of using induced mutations in crop improvement. (Proc. DAE_BRNS Symp), Mumbai, India, 27-35 (2000).
6. Pawar, S.E. *et al.* Use of induced mutations in the breeding of pulse crops. In: Proc. IAEA Symp. On Plant Mutation Breeding for Crop Improvement. June 18-22, 1990 Vol. I. IAEA. Vienna, p.413-418 (1991).
7. Robbelen, G. Mutation Breeding for quality improvement: a case study for oil seed crops. *Mutation Breeding Review* **6**, 1-44 (1990).

Development of Improved Varieties of Rapeseed and Mustard Through *In Vivo* Mutagenesis and Hybridization in Pakistan

A S Syed* & K Rahman

Abstract

Rapeseed and mustard are the second most important source of vegetable oil in Pakistan. However, due to low productivity, these crops have been pushed to marginal lands, which resulted in a narrow genetic base. Mutation breeding research in conjunction with classical breeding techniques were therefore initiated at NIFA in 1989 to induce useful genetic variability in characters of economic importance in Oilseed Brassicas. The research efforts have resulted in the development of three varieties, namely Abasin-95 in 1996, NIFA-Raya in 2003 and Durr-e-NIFA in 2005. These varieties were approved by Seed Council of North West Frontier Province (NWFP) for commercial cultivation in the irrigated and rainfed areas of the province. Abasin-95 and NIFA-Raya are the first ever mutant varieties respectively of rapeseed and mustard in Pakistan. Durr-e-NIFA was developed from a hybridized population of a cross between 'Dunkeld' and 'Abasin-95'. All the three varieties possess high yield potential, medium-to-high oil content, early maturity and broader adaptability to rainfed and irrigated environments in comparison with the local check varieties and respective parents. These varieties are being cultivated by growers on appreciable areas.

This paper reports the developmental history and performance of these varieties.

Introduction

Pakistan has been facing edible oil shortage for the many years despite modest progress made in the development of agricultural sector. The total domestic requirement of edible oil during 2006-07 was 3.107 million tons, out of which 0.857 million tons was locally produced and rest (1.787 million tons) was imported to meet the short fall, which cost the national exchequer a huge sum of more than 1.3 billion US dollars during 2006-07 [1, 2]. The huge bill for imported edible oil can be reduced considerably by increasing domestic oilseed production. Rapeseed (*Brassica napus* L. and *Brassica campestris* L.) and mustard (*Brassica juncea* L.) are important oilseed crops in Pakistan and their share in total area and production of all oilseed crops grown in the country is over 31% and 28% respectively [1]. The area and production of canola (*Brassica napus* L.) has been increased by over 300% during 2000-01 to 2006-07 [2]. Brassica oilseeds are well entrenched in the cropping system of Pakistani growers, and hold promise in narrowing the gap between production and consumption if made competitive with other field crops [3]. The oilseed Brassica improvement programme at NIFA is therefore directed towards evolving high-yielding canola quality (low in erucic acid and glucosinolates) varieties of rapeseed and mustard, with high oil content and tolerance to biotic and abiotic stresses. This paper reports the development and release of two mutant varieties i.e. Abasin-95 of rapeseed and NIFA-Raya of mustard, and one hybrid variety, Durr-e-NIFA, of rapeseed for commercial cultivation in NWFP.

Materials and Methods

The procedure outlined in [4] was followed for induction of mutations and raising M_1 to M_3 generations. About 10,000-15,000 uniform seeds of canola cv. Tower and Canadian Canola type mustard line, DLJ-3, with about 8-10% moisture were irradiated at 1,000, 1,200, and 1,400 Gy gamma rays (^{60}Co gamma source) in 1988 and 1994-95 respectively. The treated seeds in both cases were planted in the field in isolation as M_1 generation. Selection for desirable mutants was carried out in M_2/M_3 . RM-152-2 was selected in M_3 while MM-1266 was selected in M_2 from rapeseed and mustard mutagenized populations respectively. In case of hybridization, an Australian Canola type variety "Dunkeld" was crossed with mutant variety "Abasin-95" during 1995-96. A recombinant line "NH-97-1/5-1" was selected in F_2 . After confirming genetic stability of these mutants and recombinant line "NH-97-1/5-1," they were thoroughly assessed for yield in different replicated trials at NIFA, Multi-location Adaptation Yield Trial (MLAYT) in NWFP and National Uniform Rapeseed/Mustard Yield Trials (NURYT, NUMYT) through out Pakistan, which were laid out according to Randomized Complete Block Design (RCBD) with four replications, having six rows, 5m long and 30 cm apart. The yield trials data were analyzed using computer software [5]. The seed quality of different genotypes for total oil content, fatty acid profile and total seed glucosinolates were analyzed by Near Infrared Reflectance Spectroscopy (NIRS) system at NIFA Oilseed Analytical Lab.

Results

Abasin-95

The M_3 mutants of cv. Tower were tested in Preliminary Yield Trial (PYT) during 1990-91 at NIFA and mutant RM-152-2 significantly out-yielded the parent (Tower) and a commercial cultivar (PR-7) by producing 1994 kg/ha grain yield. This mutant was tested in Advanced Yield Trials (AYT) during 1991-92. RM-152-2 again significantly out yielded the control cvs. and produced 2308 kg/ha grain yield against 1,632 kg/ha yield of control cvs. [Table 1]. RM-152-2 was assessed simultaneously in a MLAYT in NWFP and in a 30-entry NURYT for two consecutive years, i.e. 1992-93 and 1993-94.

In MLAYT, RM-152-2 significantly out-yielded the check variety in all locations in both the years, producing 2049 kg/ha grain yield (Table 1). The summary of yield and agronomic data of NURYT are presented in Table 2. This mutant line produced third highest grain yield of 1,605 kg/ha amongst 30 entries (candidate varieties) for two consecutive years in NURYT (average of 15 locations). RM-152-2 outclassed Pak cheen by 13.3% & DGL by 5.2% (two non-canola controls), and Shiralee and Westar (two canola controls) by 10.2% and 18.4% respectively. RM-152-2 matured significantly earlier than control cvs. ranging from six to 18 days, at different irrigated and rainfed sites in the national trials. These results clearly indicated genetic stability of RM-152-2 over years and locations. Results regarding oil content, erucic acid and glucosinolates [Table 3] indicated that RM-152-2 possessed 46% oil (range 43-47% at different sites) against the 42% of Tower (parent) and 43% of Pakcheen

Nuclear Institute for Food and Agriculture (NIFA), P. O. Box-446, Peshawar-25000, Pakistan

E-mail: sanwarshah@nifa.org.pk

(control). It contains less than 3% erucic acid ($c_{22,1}$) and 25 micromoles total glucosinolates per gram of oil free meal, hence RM-152-2 falls in to the canola standard of Pakistan [6], which requires less than 5% erucic acid in oil and less than 40 micromoles of total glucosinolates per gram of oil-free meal. Based on its high yield potential, early maturity and its broader adaptability to diversified climates, RM-152-2 was approved by the NWFP Provincial Seed Council in December 1996 for irrigated and rainfed areas of NWFP under the name of Abasin-95 [7]. Abasin-95 was also approved and registered by the National Seed Council in 1997 as an improved mutant variety of rapeseed in Pakistan.

Table 1. Summary of yield and other characteristics of Abasin-95 and commercial cultivars in PYT, AYT and MLAYT from 1991 to 1994

Cultivars	Maturity (days)	Plant height (cm)	Yield /ha (kg)
PYT			
RM-152-2 (Abasin-95)	175.5	179.3	1994
PR-7 (Control)	177.0	175.4	1523
Tower (Parent)	171.0	180.8	1516
AYT			
RM-152-2 (Abasin-95)	170.0	168.8	2308
PR-7 (Control)	179.5	169.9	1632
Tower (Parent)	173.4	189.7	1598
MLAYT, NWFP (average of 6 locations)			
RM-152-2 (Abasin-95)	-	-	2049
PR-7 (Control)	-	-	1542
Tower (Parent)	-	-	1600

Table 2. Summary of yield and other characteristics of Abasin-95 and commercial cvs. in NURYT, 1992-93 and 1993-94 (mean of 15 sites)

Cultivars	Maturity (days)*	Plant height (cm)*	1000 seed wt. (gm)*	Yield /ha (kg)	Yield increase of RM-152-2 over controls (%)
RM-152-2 (Abasin-95)	172.6 (164-184)	162.4 (150-180)	4.4 (3.7-5.1)	1605.1 (Potential 3.3 t)	
Pakcheen (Control)	175.9 (160-184.5)	156.3 (133-175.7)	3.8 (2.8-5.0)	1416.3 (Potential 2t)	13.3
DGL (Control)	177.0 (166-186)	151.6 (124.1-175.1)	4.1 (3.1-5.7)	1526.3 (Potential 2.50)	5.2
Shiralee (Control)	179.3 (168-188)	159.6 (134-197)	3.4 (2.9-4.2)	1456.9 (Potential 2.4)	10.2
Westar (Control)	178.7 (158-187)	156.9 (131-185)	3.6 (2.9-4.9)	1355.2 (Potential 2.2)	18.4

*Data recorded at different locations is given within parenthesis.

Table 3. Oil content, erucic acid and total glucosinolate of RM-152-2 (Abasin-95), Pakcheen and Tower (control)

Entry name	Oil content (%)*	Erucic acid (%)	Glucosinolates (μ mole/g)
RM-152-2 (Abasin-95)	46.0 (43-47)	02.98	25.0
Pak cheen (Control)	43.0 (41-44)	33.52	68.8
Tower (Parent)	42.3 (41-43)	10.31	41.9

*Ranges are given within parenthesis.

NIFA- Raya

The stable mutants of DLJ-3 were tested for yield and other agronomic traits in different yield trials. The summarized results of these trials are presented in **Table 4**. MM-1266 produced highest yield (1908 kg/ha) and significantly out-yielded the parent by a margin of 100% in PYT. The following year, MM-1266 was tested in AYT at NIFA. The line

exhibited sustainable yield performance (2042 kg/ha) and produced 84% more yield than the control (parent). Based on yield performance of MM-1266 in PYT and AYT under irrigated conditions, it was tested in a 16-entry MLAYT in NWFP during 1999-2000. The pooled data over site indicated that MM-1266 produced over 1,458 kg/ha grain yield and significantly out-yielded the parent by a margin of 63%, which was used as check (in three irrigated and two rainfed environments). MM-1266 was assessed for adaptability in diversified environments through out Pakistan in NUMYT for two consecutive years. MM-1266 out yielded the non-canola check (BM-1) in six out of 14 sites in NUMYT, during 2000-01 and 2001-02. MM-1266 also out yielded Pb-10, the low erucic acid candidate variety, by a wide margin in all locations in these trials.

Initially seed of MM-1266 contained high oil content (range 44-47%) with 1.30% erucic acid and 22 micro moles of total glucosinolates per gram oil-free air dried solid [**Table 5**]. Thus MM-1266 is well within the canola standards of Pakistan [6] and its oil is fit for human use and meal for animal feed. MM-1266 is uniform, stable and morphologically distinct from the parent cultivar. The NWFP Provincial Seed Council approved MM-1266 on October 8, 2003 for sowing in irrigated and rainfed areas of NWFP under the name of NIFA-Raya [8].

Table 4. Summary of yield and other characteristics of MM-1266 (NIFA-Raya) and commercial cvs. in different yield trials, 1997-2002

Cultivars	Maturity (days)	Plant height (cm)	Yield /ha (kg)
PYT			
MM-1266 (NIFA-Raya)	101	201.2	1908
BM-1 (Control)	75	205	1280
DLJ-3 (Parent)	147	273.7	950
AYT			
MM-1266 (NIFA-Raya)	96.2	211.5	2041.8
BM-1 (Control)	-	-	-
DLJ-3 (Parent)	140.7	289.7	1104.5
MLAYT, NWFP (average of 5 locations)			
MM-1266 (NIFA-Raya)	-	-	1458.6
DLJ-3 (Parent/check)	-	-	892.3
NUMYT (2 Yrs. Average of 14 locations)			
MM-1266 (NIFA-Raya)	-	-	1518
BM-1 (Control)	-	-	1610
Pb-10 (canola line)	-	-	1238

Table 5. Oil content, erucic acid and total glucosinolate of MM-1266 (NIFA-Raya), BM-1 (control) and BP-10 (candidate variety)

Entry name	Oil content (%)	Erucic acid (%)	Glucosinolates (μ mole/g)
MM-1266 (NIFA-Raya)	44-47	1.3	22.0
BM-1 (Control)	40.8-42.0	49.7	104
Pb-10	42-44	0.9	41

Durr-e-NIFA

The stable recombinant line 'NH-97-1/5-1' was tested for yield and other agronomic traits in PYT during 1999-2000, AYT during 2000-01, MLAYT during 2001-02 and NURYT during 2002-03 and 2003-04 trials. The summarized results of these trials are presented in **Table 6**. NH-97-1/5-1 produced the highest yield (2168 kg/ha) and significantly out-yielded the parent/control in PYT. The following year, NH-97-1/5-1 repeated the excellent performance in AYT at NIFA and exhibited sustainable yield performance (2630 kg/ha) and produced over 25% more yield than the parent and 29% than check. Based on yield performance of

NH-97-1/5-1 in PYT and AYT under irrigated conditions, it was tested in a 16-entry MLAYT in NWFP during 2001-02. The pooled data over sites indicated that NH-97-1/5-1 produced 2,083 kg/ha yield and significantly out-yielded the parent and check varieties. The line was assessed for adaptability in diversified environments throughout Pakistan in NURYT for two consecutive years, 2002-03 and 2003-04. NH-97-1/5-1 produced 1,855 kg/ha grain yield and out yielded the check varieties (Shiralee and Dunkeld) on the basis of an average of 20 locations in both the years by a margin of 12.5% and 21.5% respectively. NH-97-1/5-1 contained oil content ranging from 39.6 to 42.9% with 2.4% erucic acid and 19 micromoles of total glucinolates per gram oil-free air-dried solid [Table 7]. Thus NH-97-1/5-1 is well within the canola standards of Pakistan [6]. Based on high yield potential and its wider adaptability to diversified climates, NWFP Provincial Seed Council on September 18, 2005 approved NH-97-1/5-1 as new improved variety under the name of Durr-e-NIFA for commercial cultivation in irrigated and rainfed areas of NWFP [9].

Table 6. Summary of yield and other characteristics of Durr-e-NIFA and commercial cvs. in different yield trials, 1999-2004.

Cultivars	50% flowering (days)	Plant height (cm)	Yield/ha (kg)	Aphid ¹ Attack	Alternaria blight ²
PYT					
NH-97-1/5-1 (Durr-e-NIFA)	116.5	190.7	2168	2.0	MR
Abasin-95 (Control/Parent)	109.5	198.9	2067	3.0	MR
AYT					
NH-97-1/5-1 (Durr-e-NIFA)	99.0	182.5	2630	2.1	MR
BM-1 (Control)	80.8	210.0	2020	2.3	R-MR
Abasin-95 (Parent)	101.3	201.0	2100	2.9	MR
MLAYT, NWFP (average of 6 locations)					
NH-97-1/5-1 (Durr-e-NIFA)	-	-	2083	-	-
Abasin-95 (Parent)	-	-	1641	-	-
BM-1 (Control)	-	-	1147	-	-
NURYT (2 Yrs. average of 20 locations)					
NH-97-1/5-1 (Durr-e-NIFA)	-	-	1855	-	-
Shiralee (Control)	-	-	1649	-	-
Dunkeld (Parent)	-	-	1527	-	-

¹ Aphid attack was recorded on the basis of aphid colony size (cm) on the main branch.
² R-Resistant, MR: Moderately Resistant

Table 7. Oil content, erucic acid and total glucosinolate contents of Durr-e-NIFA and control

Entry name	Oil content (%)	Erucic acid (%)	Glucosinolates (μ mole/g)
NH-97-1/5-1 (Durr-e-NIFA)	39.6 – 42.9	2.4	19.0
Shiralee (Control)	36.1 – 41.8	4.0	60.0

Discussion

Gamma-ray induced mutations have been instrumental in creating useful genetic variability in characters of economic importance in rapeseed and mustard cultivars, which led to the development of improved mutant varieties. The improvement made in some polygenically inherited characters through induced mutations, such as grain yield and seed oil content, might be due to genetic changes induced in certain other

related but simply inherited characters like plant architecture, photoperiod response and seed coat, which could have positive effects on seed yield and oil content [10, 11, 12,]. The Canadian canola germplasm is photoperiod sensitive under Pakistani conditions as such germplasm is bred and adapted to a long photoperiod (usually about 17 hours daylight) and hence not adapted to the short day length of winter season (about nine hours daylight) in Pakistan. The Canadian canola cultivars therefore, have more vegetative growth period and very short reproductive phase due to which they grow very tall and produce less grain yield. The success of development of mutant variety 'Abasin-95' and 'NIFA-Raya' from mutagenized population of respectively Canadian variety 'Tower' and 'DLJ-3' through gamma irradiation was possible only by breaking the photoperiod sensitivity and a clear manifestation of Gamma-ray induced useful mutations. Other researchers [13, 14, 15, 16, 17] reported results that are in full agreement with our findings.

ACKNOWLEDGEMENT

The authors gratefully acknowledge the partial funding of research by IAEA under different projects from 1989 to 1999, which led to the evolution of **Abasin-95** and **NIFA-Raya** varieties and creation of useful germplasm, from which later on **Durr-e-NIFA** was evolved.

The administrative and technical help extended by Director, NIFA and other colleagues during the course of development of these varieties is also acknowledged.

BIBLIOGRAPHY

- Anonymous. Agricultural Statistics of Pakistan, Federal Bureau of Statistics, GOP, Islamabad, (2007).
- Personal Communication. Pakistan Oilseed Development Board, Islamabad (2008).
- Syed, A.S., Ali, I., Rahman, K. Improvement of rapeseed for agronomic and quality characters through induced mutations and hybridization, IAEA-TECDOC-781, Vienna, 25-35 (1994).
- International ATOMIC ENERGY AGENCY. Induced Mutation Techniques in breeding self-propagated species, Manual on Mutation Breeding, 2nd Edi. IAEA, Vienna, 126-131 (1997).
- Michigan State University, USA. MSTAT-C, A Microcomputer Programme for the Design, Management and Analysis of Agronomic Research Experiments, (CD- ROM) (1983-93).
- Anonymous. Pakistan Standard Specifications for refined low erucic acid rapeseed/mustard oil (Canola oil), Pak Standards Institute, 1-4 (1991).
- Anonymous. Minutes of the Provincial Seed Council, 13712-34/A-40/Tech/DGR: p.5 (1996).
- Wadud, A. Minutes of the provincial Seed Council 9464-84/DGR p.6 (2003).
- Anonymous. Minutes of the 27th Provincial Seed Council Meeting, 11618-41/A-40/Tech/DGR p.5 (2005).
- Micke, A. Use of mutation induction to alter the ontogenetic pattern of crop plants. *Proc. Gamma Field Symp.* **18**, Ohmiya, Japan, 1-23 (1979).
- Micke, A., Donini, B., Maluszynski, M. Induced mutation for crop improvement. *Mut. Breed. Review* **7**, IAEA, Vienna, 1-16. (1990)
- Ahmad, S.U., Ahmad, F. Effect of irradiation on *Brassica* spp. *J. Uni. Kuwait* **6**, 153-157 (1979).
- Robbelen, G. Mutation breeding for quality improvement, A case study for oilseed crops. *Mut. Breed. Review* **6**, IAEA, Vienna, 3-5 (1990).
- Robbelen, G. Status and aspects of rapeseed breeding, *Proc. Advisory Group Meeting*, IAEA, Vienna, 103-117 (1982).
- Rahman, A., Das, M.L., Howlader, M.A.R., Mansur, M.A. Promising mutants of *Brassica campestris*. *Mut. Breed. Newsletter* **29**, 14-15 (1987).
- Oram, R. N., Kirk, J.T.O. Breeding Indian mustard for Australian conditions. *Proc. 6th Australian Agronomy conf.*, 467-470 (1992).
- Kumar, P.R. Radiation induced variability in improvement of brown sarson. *Rad. Bot.* **12**, 309-313 (1972).

M 127- A Promising Tomato Variety Developed Through Induced Mutation Technique

R Peiris*, T K Wickramasinghe & S P Indrasena

Abstract

Bacterial wilt (BW) is the most serious constraints for tomato cultivation in Sri Lanka. At present, the producers and consumers are more interested in yield and quality of produce. The objective of this study was to develop genotypes having BW resistance, high yield potential (>20 t/ha) with desirable fruit qualities. Application of induced mutations was practiced on the Manik variety. It is a well-adapted variety with BW resistance, large fruit size with low fruit weight (76 g) due to large empty locular cavities. Several beneficial mutants better than the parent variety were identified in the M_2 generation and confirmed in the M_4 generation. The five most promising mutants were evaluated for BW resistance, fruit quality and yield. During dry and wet seasons, the yield evaluation studies were conducted in research and farmers' fields. The mutant M 127 gave significantly higher yields (32.2 t/ha) than the check variety T 245 (21.7 t/ha) during the both seasons. Bacterial wilt screening in the field and laboratory demonstrated that M 127 was moderately resistant. The National Coordinated Varietal Trials confirmed that it was a promising mutant under different agro-ecological zones in both dry and wet seasons. Farm trials indicated that farmer acceptability was higher for the mutant than the check variety. The mutant M 127 possesses high fruit weight (158.6 g), red, slightly flattened firm fruits. It is highly acceptable for table purposes. In the near future the mutant M 127 will be officially released to farmers and at present, it is utilized as a donor parent in the development of new HF3 hybrid under the heterosis breeding programme.

Introduction

Tomato (*Lycopersicon esculentum* Mill) is one of the most widely cultivated vegetables in Sri Lanka. Bacterial wilt (BW) is the most devastating soil borne disease affecting the yield of the crop. Therefore, in the past much attention has been paid to the development of varieties that have BW resistance. However, at present the producers and consumers are more interested in yield and quality of the produce. Therefore, this study was initiated at Horticultural Crops Research and Development Institute from 1996-2005 with the objective of developing genotypes that have high yield potential (>20 t/ha) with desirable fruit quality characters. Application of induced mutations was practiced on the Manik variety, a well adapted variety, which has BW resistance and poor fruit quality characters such as irregular shape, low fruit weight (76 g) due to large empty locular cavities.

Materials and Methods

About 5,000 seeds of the Manik variety were irradiated with 320Gy Gamma-rays and seeds were sown in upland nursery beds to establish the M_1 population [1, 2]. The 14-day-old seedlings were transplanted in the field with the spacing of 80 cm between rows and 50 cm between

plants. Recommended fertilizer levels of 50 kg N/ha, 150 kg P_2O_5 /ha and 80 kg K_2O /ha were applied at appropriate time. Stacking of plants was done 20 days after transplanting. Weeding and irrigation were carried out as required. Three rows of control (untreated) seedlings were planted at both ends of each plot. Various preliminary observations from seedling to maturity were recorded on 100 randomly tagged plants of treated and untreated material. At maturity, fruits from first raceme and second raceme were harvested separately from each surviving M_1 plants to form the M_2 population. Fruit progenies of the M_2 generation consisted of 10,000-15,000 plants. Each fruit progeny had 21 plants. Three rows of original variety (control) were planted at both ends of each plot for screening. The M_2 populations were thoroughly screened for mutations. Mutants were selected on the basis of BW resistance, earliness yield/plant, fruit color, size and shape. Several beneficial mutants better than the parent variety Manik were identified. For the confirmation of mutants, the generations were advanced up to M_4 . The 10 most promising mutants were evaluated in preliminary observational plots and five were selected for yield evaluation studies. The yield of the mutants was tested during dry and wet seasons in Randomized Complete Block Design with three replications with the check variety T 245.

The plot size was 2.4 cm×3.5 cm with 3 rows/plot and 21 plants/row. The field establishment method was similar to raising of the M_1 generation. Data on days to 50 % flowering, plant height at first harvest, plant type, reaction to BW disease, marketable fruit yield/plot and fruit quality characters such as fruit weight, fruit size, shape, color, brix, number of locules and % acidity as citric acid were recorded.

Bacterial wilt screening was conducted in the field and laboratory. In the laboratory the disease was recorded at three-day intervals from day after inoculation with an isolation of *Ralstonia solanacearum* using the following scale:

0	No symptom
1	One leaf wilt
2	Two or three wilted
3	All leaves wilted except top two or three
4	All leaves wilted
5	Plant death

The type of plant reaction was based on disease percentage as follows:

Highly resistant (0)	0%
Resistant (1)	1-25%
Moderately resistant (2)	26-50%
Moderately susceptible (3)	51-75%
Susceptible (4)	76-99%
Highly susceptible (5)	100 %

Horticultural Crops Research and Development Institute, Gannoruwa, Peradeniya, Sri Lanka

* Corresponding author. E-mail: peirisranjani@yahoo.com

The mutant M 127 was tested in National Coordinated Varietal Trials (NCVT) in different agro-ecological zones. The standard yield evaluation procedure was carried out in NCVT. Finally it was tested in farmer fields during wet season (10 sites) and dry season (five sites) using T 245 as the check variety.

Results and Discussion

In the M₁ generation, seedling emergence, seedling survival at 14 days and at maturity decreased in treated population. Days of flowering delayed in treated population (Table 1).

Table 1. The performance of the M₁ generation population of tomato variety Manik

Parameter	Untreated	Treated
Emergence at 7 days	98.5	86.5
Seedlings survival at 14 days	86.0	62.0
Days of 50 % flowering	42.0	49.0
Plant survival at harvest	82.0	52.7

In the M₂ generation, several beneficial mutants better than the parent variety were observed. In the M₄ generation, 10 promising mutants were identified and five were selected for further evaluation. The BW screening data of the selected five mutants is given in Table 2.

Table 2. BW reaction of the selected mutants.

Variety / Mutant	Reaction 1	Reaction 2
M 110	MR	MR
M 121	MR	R
M 127	MR	R
M 120	MR	MR
M 65	R	MR
Manik	R	R
Marglobe*	S	S
KWR**	HR	HR
Reaction 1- In the laboratory	HR - Highly resistant	
Reaction 2- In the field	R - Resistant	
* Susceptible check	MR - Moderately resistant	
** Resistant check	S - Susceptible	

Yield evaluation of mutants carried out during the dry and wet seasons in the research fields clearly revealed that there were significant differences in yield among the mutants or varieties (Table 3). Out of the tested mutants, M 127 was found to be most promising giving an average yield of 32.2 t/ha.

Table 3. Yield performance of mutants and check variety T 245 in research trials

Mutant/Variety	Dry season	Wet season
M 110	26.2c	22.3c
M 120	27.8bc	21.5c
M 121	28.2b	26.9b
M 127	32.2a	28.2a
M 65	18.2 e	12.4 f
T 245	20.8 d	20.7 d
Manik	18.0 e	18.1 e
CV %	10.0	10.2

Means followed by the same letter are not significantly different at 5% level based on DMRT

Fruit quality characters of M 127, Manik and T 245 are presented in Table 4.

Table 4. Fruit quality characters of M 127, Manik and T 245.

Variety	Weight (g)	Color	Shape	Locules Number	Citric Brix Acid %	Size	Locule Mutant cavity
M 127	158.0R	SF	5	1.1	4.5	B	F
T 245 (check)	80.5	OR	SF	6	0.9	4.1	M
Manik (Parent)	50.2	ORYS	BL	7	4.0	0.4	B
R - Red		OR - Orange					ORYS - Orange red yellow shoulder
SF - slightly flattened		BL - Blocky					
B - BigF - Filled		M - Medium					
		E - Empty					

M 127 had slightly flattened, red, heavy fruits (158.0 g), whereas the parent variety, Manik had blocky shape, orange-red fruits with yellow shoulder and low fruit weight (50.2 g).

In the NCVT trials conducted for more than one season in different agro-ecological zones, clearly revealed that M 127 has a better yield potential than the check variety T 245 (Table 5).

Table 5. Yield (t/ha) of M 127 and T 245 in National Coordinated Varietal Trials

Variety/ Mutant	Agro-ecological zone			
	Wet zone	Intermediate zone		Dry zone
	Mid country (a)	Low country (b)	Up country (c)	Low country (d)
M 127	32.8	25.8	30.3	12.7
T 245 (check)	20.8	19.8	20.1	10.2

(a) Gannoruwa — Average of 06 seasons
 (b) Makandura — Average of 3 seasons
 (c) Bandarawela — Average of 3 seasons
 (d) Mahailupallama — Average of 3 seasons

In all agro-ecological zones, the mutant gave higher yields than the check variety T 245 (Table 5). On-farm trials conducted in 15 sites indicated that farmer acceptance of M 127 mutant variety was higher than the check variety T 245. The farmers also reported fewer incidences of pest and diseases and good keeping quality in M 127 mutant variety.

Conclusion

M 127 is a promising mutant that has moderate resistance to BW, high yield potential (32.2 t/ha) and acceptable fruit quality characters such as high fruit weight (158.6 g), red, slightly flattened firm fruits with a long shelf life (14 days). In near future, M 127 will be officially released to farmers and at present it is utilized as a donor parent in a heterosis breeding programme.

BIBLIOGRAPHY

- Konzak, C.F., Mikaelson, K. Induced Mutation Techniques in Breeding Self-pollinated Species. In Manual on Mutation Breeding, Sec.Edn. 126-131. IAEA, Vienna (1977).
- Micke, A., Donni, B., Maluszynski, M. Induced Mutation for Crop Improvement. In Mut. Breed Review 7,1-16. IAEA, Vienna (1990).

Induction of Dormancy in Spanish Groundnut Seeds (*Arachis hypogaea* L) Using Cobalt-60 Gamma Irradiation

N Benslimani^{1,*} & L Khelifi²

Abstract

Irradiation has been used in several countries to create genetic variability in groundnut (*Arachis hypogaea* L). Several mutated lines were isolated. Our research aims are to induce genetic variability to make a selection of an improved local population of groundnut especially with regard to the dormancy characteristic of the seeds. In this context, dried seeds (14% moisture content) of four Spanish-type local groundnut populations were treated with the dose range of 50 to 450Gy in order to study their radiosensitivity at the laboratory level. The optimal irradiation doses were determined for two groundnut populations Berrihane (P1) and Tonga oust (P3). The measurement of field agronomic characters allowed us to choose a single population that was investigated during two generations. The obtained results have shown a significant effect of irradiation through statistical analyses. Concerning the seed dormancy tested on every M₂ plant, the obtained results demonstrated the existence of such a feature. However, one has to wait for the next generations in order to evaluate the evolution of the dormancy characteristics with respect to time.

Introduction

Radiomutagenesis is known to significantly improve the appearance frequency of induced changes. It can thus be used to widen the genetic variability to be integrated in many varieties selection and creation diagrams [1]. It enabled the improvement of many characters for different species: lupin, chickpea and groundnut [2]. Fundamental work regarding groundnut was carried out. It focused on various mutagen agent effects: X-rays [3]; [4] fast neutrons [5]; Gamma-rays [6]; [7] and chemical agents [8]. That work dealt with improvable characters (ramifications, morphology of the young shoots, maturity, seeds and pods morphology). Thirty-three cultivars were obtained worldwide. Twenty of them were developed in China. Nineteen varieties were created directly by a selection of mutant plants resulting from mutagen-treated seeds. The remaining 14 were obtained after a selection from crossings making use of mutant lines [2].

Two types of groundnut features are generally aimed at:

1. Characters related to the adaptation to the ecological and agro-technical conditions.
2. Characters related to the use of the obtained types (size, form, aspect, contents of oil and proteins, cellulose, organoleptic quality, resistance to seeds handling) [9].

The Virginia groundnut type exhibits a seed dormancy ranging from one to three months after harvest. This character is a significant agronomic advantage as it prevents premature field germination [10]. However, the Spanish type does not exhibit such dormancy. They constitute the targeted population of the present work which focuses on the Spanish type groundnut dormancy character. It consists of inducing

gamma radiation changes on four Spanish type Algerian groundnut populations in order to produce mutant lines with dormant seeds [11]. These would enable farmers to obtain an adapted variety and to thus avoid considerable production losses.

Materials and Methods

The material is composed of four local non-dormant groundnut seeds (P₁: Berrihane, P₂: Boumalek, P₃: Tonga Ouest and P₄: El Frine), from the Algerian region of El-Kala (14% moisture content). They have been irradiated in a Co-60 unit at different doses namely: D₁ (50Gy), D₂ (100Gy), D₃ (150Gy), D₄ (200Gy), D₅ (300Gy) and D₆ (450Gy).

For the sake of studying radiosensitivity, a number of 25 seeds per dose and per population including the control are germinated in Petri dishes containing filter paper. They were afterwards soaked in water then placed in a controlled atmosphere room (temp: 22°C, humidity: 51 %, photoperiod: 16 h/day). The biological effects of the mutagen treatments were studied by surveying the percentage of stem seed germination and root's length.

Two populations and three gamma doses were retained for the field-work. Two hundred and twenty five seeds per dose and population were irradiated and sown at the National Institute for Agriculture experimental station. Each piece of land corresponded to a treatment (irradiation dose) per population. The elementary pieces were laid out in complete random blocks with five replications by population; a total of 10 blocks. Each block comprised the different doses. The seedlings of M₁ were surveyed during their whole development cycle. Every mature M₁ plant was collected together with the control. A sampling of five seedlings per dose and per population was carried out in order to investigate the main stem, root and secondary ramification lengths, ramifications' number, seedlings pods number, and weight of 100 pods. Ten mature pods were taken from each plant to survey the M₂ plants. The remainder were collected and mixed according to both irradiation dose and population to study the germination process dynamics.

The M₂ generation study was made on the Tonga Ouest M₁ plants population. For each block, the plant material was as follows: 169 M₁D₀, 161 M₁D₁, 120 M₁D₂, 110 M₁D₃ plants. Two pods for each M₁ plant including control seeds were selected and respectively numbered. The experimental device was a random block with two replications each of consisting of four basic plots for four different doses. Each dose contained various numbered plants from each seed collected for the M₁ plant. The methodology focused on the measurement of the branches, leaves, flowers, pods, seeds, roots, plant height and the germination test in every M₂ plant (single-seed descent).

Discussion

Seed radiosensitivity

Variance analysis revealed a significant population effect for the number of germinated seeds. The comparison between two populations made it possible to distinguish two homogeneous groups. Group A represents the average number of germinated seeds which is the most significant

¹ Algiers Nuclear Research Center, PO Box 399, Algiers, 16000 Algeria

² National Institute for Agriculture, El-Harrach, Algiers, Algeria

* Corresponding author. E-mail: benslimaninabila@yahoo.fr

with 24.1 and 23.4 as compared to group B which average germination number is 22.66 and 21.80 (knowing that the number of germinated seeds is 25 per population). The number of germinated seeds was neither affected by the irradiation dose nor by population-irradiation dose interaction. Consequently, the former is not a significant criterion for the useful irradiation doses choice. Hence, it becomes of interest to investigate other parameters (Fig. 1).

Average Stem Length Variance analysis does not show significant effect for this parameter. However, for all the studied populations the increase in the doses involves a significant stem length reduction, except for D₄ dose (200Gy). The two by two comparison of the average figures gives four homogeneous groups (Figs. 2, 4, 5).

Average Root Length: Variance analysis indicates a significant population effect for this parameter. This allows one to distinguish two homogeneous groups. Group A with the P₁ population represents the most raised root length and group B being the remainder of P₂, P₃ and P₄ populations. Similarly, the root length is inversely proportional to the irradiation doses. The dose effect is highly significant. The two by two comparison of the mean values makes it possible to distinguish five homogeneous groups (Figs. 2, 3, 5).

Irradiation dose effect on stem and root growth The slowing of stem and root growth due to increased irradiation doses was observed in different species. The criterion used by Guhardja to determine useful doses is the one inducing approximately a 30% reduction in the stems' length as compared to the control [12]. Konzak and Mikaelson recommend a growth reduction ranging from 30% to 50% and advised the use of three irradiation doses (100, 200 and 300Gy) [13]. In the present case, a clear root length decrease is noted, which reaches respectively 46.5% and 59% for 450Gy. For the continuation field experiment 100, 200 and 300Gy doses are retained. This would involve about 30% of stems and roots length decrease (Fig. 6).

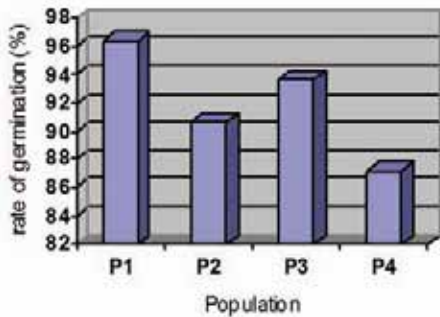

Figure 1 Population effect on seed germination (any dose)

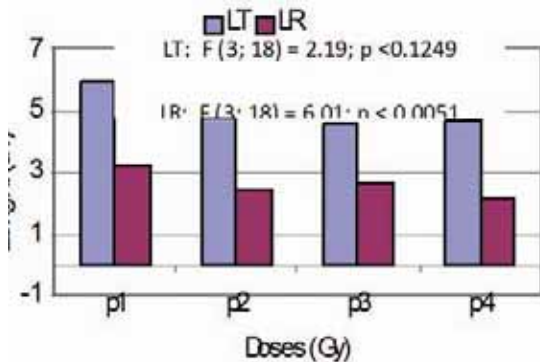

Figure 2 Population effect on the stem and root mean length (any dose)

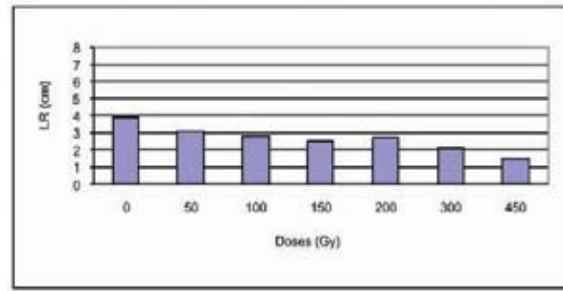

Figure 3 Irradiation doses effect on root mean length (mean of four populations).

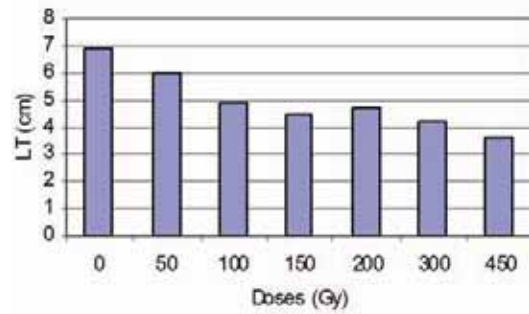

Figure 4 Irradiation effect on stem means length (mean of four populations)

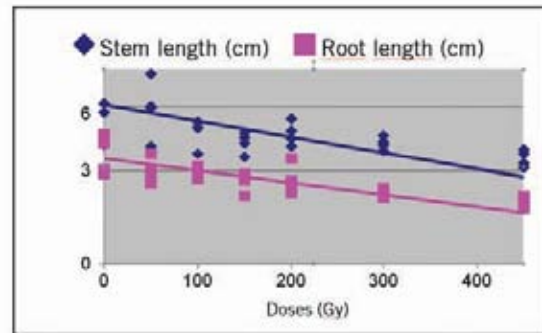

Figure 5 Irradiation effect on root and stem mean length (mean regression of four populations).

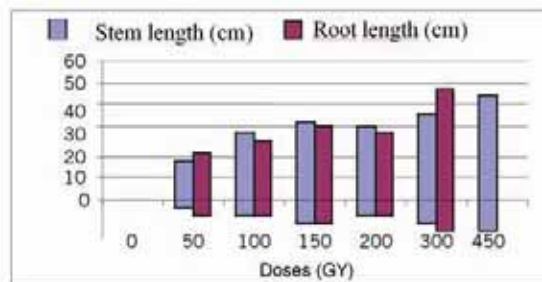

Figure 6 Doses effect on root and stem length reduction (mean of four populations).

M₁ and M₂ generations field survey

Statistical analysis for the M₁ characters (main stem length, primary branching number, main branching length, total pods weight, pod number, 15 pods weight, 15 pods seeds weight, 15 pods shell weight, shelling percentage) shows no significant effect from the doses. Therefore, the M₁ plants behave in the same way (Table 1). For M₂ characters as mentioned in the Table 1, variance analysis shows that the dose effect is significant to highly significant.

Table 1. Statistical analysis of the M₁ and M₂ characters.

Characters	M1		M2	
	F	Dose effect	F	Dose effect
Main stem length	0.55	NS	47.98	***
Primary branching number	1.03	NS	16.64	***
Main branching length	0.98	NS	117.38	***
Number of pods	0.95	NS	15.48	***
Total pods weight	0.90	NS	24.50	***
15 pods weight	1.56	NS	41.12	***
15 pods seeds weight	0.24	NS	49.97	***
15 pods shell weight	2.028	NS	7.26	***
Shelling percentage	0.22	NS	35.03	***
Biomass diameter	/	/	19.83	***
Two main branching diameter	/	/	3.53	**
Plant dry mater weight	/	/	10.77	***
Roots dry mater weight	/	/	2.64	***
Leaf surface	/	/	27.81	***
Total number of flowers	/	/	38.60	***
Total pegs number	/	/	17.12	***
Reproductive efficiency	/	/	22.13	***
Percentage of pegs fructification	/	/	3.22	*

NS: Non Significant, *: Significant, **: Highly significant, ***: Extremely significant

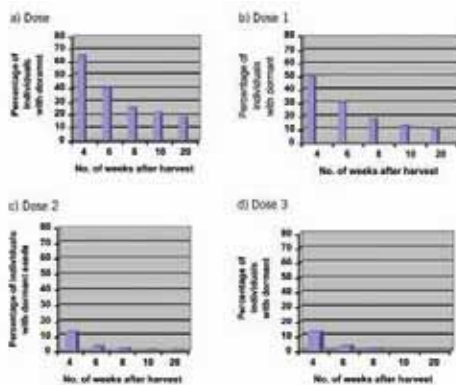
**Figure 7** Percentage of plants with dormant seeds.

Dormancy study

The germination study of the M₁ plants control, D₁ and D₂ seeds shows that all seeds have germinated after 48 hours. For M₂ seeds germination testing (all M₂ plants) the main observation made by doses is as follows: **Dose 0:** Four weeks after harvest about 65 % of individuals are dormant seeds. This rate falls after five months to reach 17%, which represents 22 individuals over 167 plants (**Fig. 7a**).

Dose 1: The same comments apply for the control at this dose, as 50% of individuals are dormant seeds four weeks after harvest. This rate rises to 15% after five months; which represents about 14 individuals with dormant seeds from 160 plants (**Fig. 7b**).

Dose 2: The decrease in the dormant seeds plants rate is rather drastic from 14% after four weeks to 0.5% after five months which corresponds to one dormant seed over 111 plants (**Fig. 7c**).

Dose 3: The same trend as for D2 has been noticed except that after 2.5 months no dormant seeds could be observed (**Fig. 7d**).

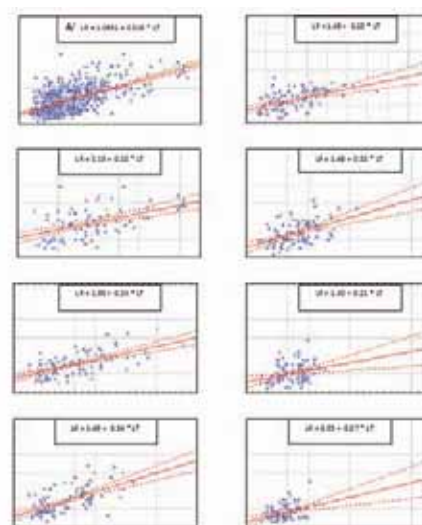
**Figure 8** Stem length - root length relationship: A (all doses and populations), D₀ to D₆ (mean of the four populations per dose).

Discussion of results

Population P₁ (Berrihane) shows a root length slightly more significant compared to the remainder of the populations for all the irradiation doses. Berrihane and Tonga Ouest populations present the most significant germinated seeds average number (laboratory test) as compared to Boumalek and El Frine.

A highly significant positive correlation between stem and root length (**Fig. 8**) is noticed for the four populations and the seven doses. This type of correlation persists for the doses D₀, D₁, D₂, D₃ and D₄. Beyond the D₄ dose, there is loss in stem-root correlation (**Fig. 8A**). This was checked on the level of the stem and root growth reduction (spherical cloud near the origin (**Fig. 8-D6**)). This reduction was already reported for other species [14]. It can be attributed to mitotic division's reduction in the meristematic apical cells [15]. In our case, the retained doses for field study seeds irradiation are: 100, 200 and 300Gy. This corresponds to the useful doses (200 – 300Gy) as suggested by Brunner to induce changes for same species [16]. This choice was also made on the basis of other studies which recommend a stem and root length reduction ranging from 30% to 50 %. For the first and second generation studies, the fundamental analysis of variance shows no significant effect of radiation doses at the M₁ level. The plants behave nearly in the same way for all doses. However, the M₂ variance analysis has helped identify a very high significant dose effect for each character study. This suggests the possibility of characters segregation for this generation. This enables one to say that the applied irradiation effects are real at the genetic level. The study of the seeds dynamic germination for the M₁ revealed an effective germination for all the seeds after 48 hours. Regarding the M₂ seeds, the obtained results show that D₂ and D₃ doses indicate significant amount of seeds germination during the first 30 days after harvest. After three months of conservation, the seeds almost do not show dormancy (appreciatively 100 % germination). Twenty-two lines of the D₀ and 14 lines of the D₁ were found to exhibit dormant seeds even five months after harvest. Consequently, the hypothesis of the presence of dormancy in local populations has to be considered. On the other hand, the effect of radiation doses should not be overlooked, since it's also the doses 200 and 300Gy which showed a complete seed germination. For the D₁, 14 lines remain dormant even five months after harvest which suggests that low radiation doses may be the cause of dormancy that is observed in

these lines. However, one must not lose sight of the fact that the lines are segregated and therefore must await future generations to draw the appropriate conclusions.

Conclusion

Regarding groundnut (*Arachis hypogaea* L), very little progress was made through the conventional improvement methods because of a lack in the germplasm genetic variability of the species. The selection after radiation induced change offers a considerable source of genetic variation. This work enabled us to study seed radiosensitivity of four local Algerian groundnut populations of the non-dormant Spanish type. This experimentation has shown that the four groundnut seed populations are totally sensitive to the applied mutagen. For the M_1 seed dormancy, there is no variation on control and gamma irradiation seeds. In the M_2 , the variation is important particularly for D_0 and D_1 . Ultimately, all results require confirmation because only two generations were analyzed. Starting from the M_3 , the most interesting plant characters will be identified and selected. The main agronomic traits will be evaluated on the selected plants in the fourth and fifth generations. The most interesting character will be confirmed in the sixth generation to obtain stable genotypes.

BIBLIOGRAPHY

- Guerin De Montareuil, P. Radioagronomie, Echos. Groupe, CEA France p.56-57 (1984).
- Micke, A. Principles of mutant selection, 15th IAEA/FAO Inter-regional Training Course on Advances in Technologies for Induced Mutations in Crops, Vienna, p.51 (1997).
- Gregory, W.C. Induction of useful mutations in the peanut. *Brookhaven Symp. Biol.* **9**, 177-190 (1956).
- Patil, S.H., Mouli, C. Radiation induced Bunchy top mutant in groundnut. *Curr. Sci* **4**, 22 (1978).
- Thakare, R.G., Pawar, S.E., Joshua, D.C., Mitra, R., Bhatia, C.R. Variation in some physiological components of yield in induced mutants of mungbean, Induced Mutations - A Tool in Plant Research (Proc. Int. Symp. Vienna 1981), IAEA, Vienna, p.213-226 (1981).
- Reddy, Ps., Reddi, Mv., Thammiraju, B. Création de la variabilité génétique par le recours à l'irradiation chez l'arachide (*Arachis hypogaea* L), Oleagineux, Fev, Vol.32, Fascicule 335, p.59-63 (1977).
- Marghitu, V., Pop, L., Chichea, I. The breeding of groundnut lines by mutagenesis and individual selection suited to the soil and climate of southern Oltenia. *Genetica Theoretica*, **14**, 49-59 (1982).
- Ashri, A., Goldin, E. The mutagenic activity of diethyl sulfate in peanuts. *Radiat. Bot.* **5**, 431-441 (1965).
- Gillier, G., L'arachide, Ed. G.P. Maisonneuve & Larose, Paris, 287 (1969).
- Geautreau, J. Lifting of dormancy of groundnut by Ethephon in the substances of growths in Agriculture, 2 Vols, Practical Applications, p.253-258 (1983).
- Benslimani, N. Etude du comportement de l'arachide (*Arachis hypogaea* L) issue de grains soumises à des traitements mutagènes (rayons gamma, cobalt-60) : Evaluation par des critères morphologiques et agronomiques de la radiosensibilité au cours de trois générations (M0 à M2), Thèse Magistère, INA p.200 (2003)
- Cheah, E.S Lim. Mutagenesis applied to the improvement of *Phaseolus vulgaris* as grain legume crop in Malaysia, FAO/IAEA Division, Thailand 27 April- 1 Mai, p.109-116 (1988).
- Konzak, C.F., Mikaelson, K. Selection parents and handling M_1 - M_3 mutant generations for the selection of mutants, Manual On Mutation Breeding, Second Edition, FAO/IAEA Vienna, p.119-125 (1977).
- Rajput. M.A., Siddiqui. K.A. Induced mutation breeding studies for soybean improvement, Induced mutations for improvement of grain legume production II, FAO/IAEA Division, Thailand 27April-1 May, p.165-170 (1988).
- Conger, A.D., Stevenson, H.Q. Correlation of seedling height and chromosomal damage in irradiated barley seeds. *Radiat. Bot.* **9**, 1-14 (1969).
- Briggs, R.W., Constantin, M.J. Mutagenic radiation, Manual on Mutation Breeding Second Edition, Joint FAO/IAEA Division of Atomic Energy and Agriculture, Vienna, p.7-50 (1977).

Mutation Breeding for Rice Improvement in Tanzania

A Luzi-Kihupi^{1*}, J A Zakayo², H Tusekelege², M Mkuya³, N J M Kibanda³, K J Khatib⁴ & A Maerere¹

Abstract

The mutation breeding programme based at Sokoine University of Agriculture (SUA), Morogoro, Tanzania aims at reducing plant height and maturation period of popular indigenous cultivars while maintaining some of the good qualities of the parents. Dry seeds of the indigenous popular cultivars were irradiated with 170, 210, 240 and 250Gy Gamma-rays from ⁶⁰Co at IAEA Seibersdorf Laboratories in Vienna in 1987, 1994 and 2001. The irradiated seeds and controls were sown at SUA. M₁ panicles were harvested, and planted as M₂ panicle-to-row progenies. M₂ plants were selected and advanced to M₃ and subsequent generations using pedigree selection method using plant height, early maturity and grain type as selection criteria. In another procedure, Single Seed Descent (SSD) method was used, whereby one seed was randomly selected from each M₂ plant to raise the M₃ generation. Apart from this, some improved mutants have been used in the cross breeding programme. The selected variants with improved plant type have been evaluated in multi-locational trials and on farmers' fields. Mutants that were selected using single seed descent were found to be very early in maturity and were resistant to rice yellow mottle virus (RYMV). After several years of multilocation and on-farm trials, SSD 35 was released in 2005 as a new variety under the name of Mwangaza. On the other hand, the improved mutants originating from cultivar 'Salama' also combined high yield potential and resistance to RYMV. Semi-dwarf Supa mutant, M-100 was backcrossed to 'Supa' variety and one high-yielding line selected from this cross has been recommended for cultivation in Zanzibar. Other lines originating from crosses between mutants and other varieties have been found to be resistant to rice yellow mottle virus and also combine high yield potential and acceptable grain quality.

Introduction

The importance of rice in Tanzania is increasing. Currently, it is a food crop in the diet of 60 percent of the people in Tanzania whose population is growing at a rapid rate (2.8%) resulting in a continuous increase in demand for rice and pressure to increase production [1]. Current average yield in the country estimated at 1.7 tons per hectare, however this is low compared to that of other countries like Korea and Japan where yields are above six tons per hectare [2]. One of the reasons for the low yield is that the farmers grow a number of traditional varieties that are tall and prone to lodging. Moreover, these varieties have long maturation period and are not suitable for areas with marginal rainfall pattern. The occurrence of rice blast and rice yellow mottle virus has also contributed to the declining yield of rice. In order to address the above constraints, rice breeders have been employing both conventional and non-conventional breeding methods. The first programme of mutation breeding was initiated

in 1972 [3] with financial assistance from the International Atomic Energy Agency (IAEA). Faya Theresa and Kihogo Red varieties were used in the FAO/IAEA "Coordinated Mutation Breeding Programme for the Improvement of Grain Protein Content and Quality." Some mutants selected from this project combined high grain yield and high protein content [4].

The current mutation breeding based at Sokoine University of Agriculture (SUA) aims at reducing plant height and maturation period of the popular indigenous cultivars while maintaining some of the good qualities of the parents. This project was funded by the International Atomic Energy Agency in the 1990s. Prior to 1999, the project was under coordinated project titled "Improvement of Basic Food Crops in Africa through Plant Breeding Including the use of Induced Mutation." The activities were later expanded under the Technical cooperation project titled "Improvement of Basic Food Crops of Tanzania Using Nuclear Techniques" [5,6].

Materials and Methods

The materials used in these studies were the local popular varieties. Afaa Mwanza 1/159, Supa India, Salama, Kaling'anaula, Ringa Nyeupe, Kihogo Red, Usiniguse and SSD35, have so far been subjected to irradiation at the Seibersdorf laboratories in Vienna. This paper presents the improvement of Supa India and Salama cultivars.

Supa and Salama varieties (rainfed lowland and upland varieties respectively) are widely grown cultivars in Tanzania. Supa has excellent cooking and eating qualities but its yield potential is low. It is too tall, photoperiod sensitive, has a long maturation period and is also susceptible to diseases such as rice blast and rice yellow mottle virus (RYMV). Salama, which was recommended for cultivation since the late 1970s, is high yielding but too tall and susceptible to rice blast. Dry seeds of Supa and Salama cultivars were sent to Vienna for irradiation in May of 1994. The materials were irradiated using 170, 210 and 240Gy Gamma-rays from ⁶⁰Co at IAEA Laboratory, Seibersdorf, in Vienna.

The seeds of the irradiated and non-irradiated control were sown at SUA farm immediately upon arrival. The M₁ panicles were harvested, and planted as M₂ panicle-to-row progenies. M₂ plants were selected using plant height, early maturity and grain type as selection criteria and harvested individually. About 80 plants were selected per treatment and advanced to M₃ and subsequent generations using pedigree selection method. In another procedure using the same M₂ plants, Single Seed Descent (SSD) method was used, whereby one seed was randomly selected from each M₂ plant to raise the M₃ generation. The M₄ plants were selected individually and M₄ progenies were planted as progeny rows. The selected variants with improved plant type were selected and evaluated at SUA, Dakawa and KATRIN in Morogoro region, Tanzania [5].

Use of Mutants in Cross Breeding

A number of mutant lines, viz. Afaa Mwanza mutants 4, 6, 12, Salama mutant M55 and Supa mutants M-100, SSD 1, SSD35 were hybridized

¹ Sokoine University of Agriculture, Department of Crop Science and Production, P.O. Box 3005, Morogoro, Tanzania.

² Dakawa Agro-Scientific Research Center, P.O. Box 1892, Morogoro,

³ Agricultural Research Institute, KATRIN, Private Bag, Ifakara, Tanzania,

⁴ Kizimbani Agric. Research Institute, P.O.Box 159, Zanzibar

* Corresponding author. E-mail: aluzikih@yahoo.com

with different varieties such as Supa, Jefferson, PSBRC 50, IR 8 and Kihogo Red for further improvement.

Results and Discussion

The five mutants selected from irradiated 'Supa' variety using single seed descent were found to be very early maturing and resistant to rice yellow mottle virus. From the pooled data of the two sites and two seasons, all the characters except panicle weight and grain weight showed significant differences (Table 1). Rice breeders worldwide made good use of induced mutations to generate variation and produce some good varieties [7,8,9,10]. The mutants flowered earlier as compared to the parent. Short duration varieties (105-115 days) are excellent in marginal areas because they grow rapidly during the vegetative phase and are thus more competitive with weeds. They reduce weed control costs and utilize less water [11]. All the mutants except mutant SSD 35, significantly out-yielded the parent. Mutant SSD 3, which yielded the highest, had a mean of 5296 kg/ha in the two locations. Mutants SSD1, SSD3, SSD5, SSD7 and SSD35 were also resistant to rice blast and rice yellow mottle virus. These improved mutant lines were also photoperiod insensitive. After several years of multi-location and on-farm trials, SSD 35 was released in 2005 as a new variety under the name of Mwangaza. From the results presented, it is clear that mutagenesis reduced the maturity period of the

original cultivar up to 24 days. This is significant improvement on this trait. In China, Yua feng Zao variety, which matures 45 days earlier than the original variety IR 8, was developed through gamma irradiation. The new variety still has high yield potential [12].

The results of evaluation of other mutants originating from Supa and Salama varieties are shown in Table 2. The Supa mutants, though high yielding, are susceptible to blast and RYMV. However, the mutants originating from Salama cultivar combined high yield potential with resistance to RYMV (Table 2). These mutants are Salama M-19, Salama M-38, Salama M-55 and Salama M-57.

Mutants in cross breeding

In a cross breeding programme, a number of variants have been selected which combined high grain yield, good grain quality and resistance to rice yellow mottle virus (Table 3). Supa BC is a line, which was selected from a cross of a dwarf mutant of Supa (M-100) and the original Supa variety (Table 2). The line was accepted as a new variety in Zanzibar. It is still maintained on the Tanzanian mainland and shows good prospect to be released as a new variety in areas where RYMV is not a problem.

In the present study, gamma radiation was used to induce useful mutations resulting in the release of two new varieties. The improved mutants selected from the irradiated materials and the lines obtained

Table 1. Agronomic characteristics of mutants and their parent (SUA and Dakawa, Tanzania, 2001& 2002)

Genotype	Treatment	Days to 50% flowering	Plant Height (cm)	No. of Panicle/m ²	Panicle length (cm)	Panicle weight (g)	1000 grain wt.(g.)	% filled grain/panicle	Grain yield kg/ha	RYMV Score
SSD1	170Gy	71bc	118.3a	160.7	21.9c	4.3	32.9	82.2ab	4816b	1
SSD3	170Gy	72bc	127.0ab	167.2	23.9ab	4.6	32.5	81.2ab	5296a	3
SSD5	170Gy	72bc	120.0b	163.7	23.9ab	4.4	31.9	79.7b	4655b	3
SSD7	170Gy	72bc	121.1ab	168.3	23.7a	4.7	31.9	83.4ab	3799b	1
SSD35	170Gy	70c	120.0b	146.5	24.9bc	4.7	34.7	84.5a	2956c	1
Supa	Control	94a	122.1a	184.3	25.5	4.1	32.1	71.2c	2935d	7
Mean		75	120.6	165.1	23.5	4.4	32.7	80.4	4556	
Sx (+/-)		0.53	12.77	9.97	0.54	0.17	0.4	1.23	150	
CV(%)		1.73	5.63	14.8	5.62	3.1	3.1	3.76	8.46	

Table 2. Performance of Supa & Salama mutants grown at SUA, Morogoro (2002)

Plot no.	Description	Days to 50% FI	Plant height (cm)	Panicle length (cm)	Panicle/m ²	1000 grain wt (g)	Panicle wt (g)	Yield (kg/ha)	Resistance to RYMV
1	Supa M-6-11	94 a	128 a	22.2 d	139 cd	36.9 ab	1.5 a	2,660 ab	Susceptible
2	Supa M-14-17	95 a	126 b	21.9 d	145 d	32.6.1 ab	2.1 f	2,700 ab	Susceptible
3	Supa M-22-17	92 ab	128 b	22.1 d	136 cd	35.5 ab	1.7 def	2,951 a	Susceptible
4	Supa M-70-10	90 abc	126 b	22.9 d	156 bc	33.7 ab	2.6 cd	3,152 a	Susceptible
5	Supa M-101-22	93 a	119 b	22.5 d	187 ab	36.0 ab	2.0 de	2,925a	Susceptible
6	Supa-M-26-19	93 ab	129 b	23.1 d	165 bc	34.7 ab	2.2 bc	3,082 a	Susceptible
7	Supa M-106	94 a	127 b	23.1 cd	172 bc	36.4 ab	2.0 cd	3,258 a	Susceptible
8	Supa BC	85 bc	90 c	24.7 b	187 ab	26.5 ab	1.0 cd	2,676 ab	Susceptible
9	Salama M-55	87 abc	125 b	22.5 d	194 ab	32.4 ab	2.6 cd	3,161 a	Resistant
10	Salama M-19	85 bc	144 a	26.4 a	160 bc	29.2 abc	3.2 ef	2,240 bc	Resistant
11	Salama M-30	87 abc	122 b	19.9 e	211 a	31.6 bcd	2.8 bc	1,845 c	Resistant
12	Salama M-57	83 c	132 ab	24.5 bc	110 de	35.8 de	2.7 b	2,156 bc	Resistant
13	Salama (control)	83 c	145 a	23.3 bcd	92 e	27.2 de	3.6 bc	1,965 c	Resistant
14	Supa (control)	94 a	125 b	23.0 cd	161 bc	36.9 e	2.1 bc	3,150 a	Susceptible
Mean		89.6	126	23.6	158.3	33.5	2.3	2,709	
Sx (+/-)			12.64	1.52	34.6	4.01	0.83	530	
CV		4.71	5.90	3.94	13.02	7.14	21.25	14.58	

Table 3. Grain quality characteristics of some RYMV resistant rice genotypes

S/n	Cross	Grain length (mm)	Size category	Length:breath	Grain shape	Gelatiniza- tion Temp.	Amylose content (%)	Type
1	Mutant 12 /M-100/ Supa	6.825	Long	2.382	Medium	Low	24.87	Intermediate
3	Mutant 6 /Salama M-55	7.295	Long	2.906	Medium	Low	25.85	high
8	Mutant 12/PSBRC 50	6.4	Long	2.169	Medium	Low	26.12	high
9	Mutant 12/PSBRC 50	7.3	Long	2.684	Medium	High	22.38	Intermediate
10	Jefferson/SSD1	7.075	Long	2.67	Medium	Intermediate	23.27	Intermediate
11	Jefferson/SSD1	7.485	Long	2.752	Medium	High/Intermediate	22.65	Intermediate
23	Jefferson/SSD 35	7.665	Extra long	2.898	Medium	High/Intermediate	20.78	low
25	Jefferson/ SSD 35	7.605	Extra long	2.848	Medium	High/Intermediate	22.65	Intermediate
32	Jefferson/SSD 35	7.805	Extra long	2.864	Medium	Intermediate	22.3	Intermediate
49	IR 8/M-100/Supa	7.97	Extra long	2.903	Medium	High	24.43	Intermediate
52	IR 8/M-100/Supa	7.63	Extra long	2.852	Medium	High	21.76	Intermediate
59	IR 8/M-100/Supa	6.955	Long	2.322	Medium	High	22.47	Intermediate
68	M-100/Kihogo Red	6.705	Long	2.883	Medium	Intermediate	20.7	low
69	M-100/Kihogo Red	6.74	Long	2.774	Medium	Intermediate	18.01	low
70	Supa (Control)	7.585	Extra long	2.69	Medium	Intermediate	15.45	low
71	M100 (Control)	6.36	Medium	2.634	Medium	Low	11.45	low
72	Kihogo Red (Control)	6.545	Long	2.503	Medium	Low	20.96	low

from cross breeding will be a suitable source of germplasm in breeding and genetic studies.

ACKNOWLEDGEMENTS

The authors are grateful to the International Atomic Energy Agency for financial support. Many thanks are due to Mr. Aggrey Mwanjabe, Senior field Assistant at SUA for fieldwork.

BIBLIOGRAPHY

- INTERNATIONAL RICE RESEARCH INSTITUTE, Rice Almanac, International Rice Research Institute, P.O.Box 933, Manila, Philippines. p.97-99. IRRI, CIAT, WARDA (1997).
- FAO, FAO Production Yearbook. Vol.48. FAO, Rome (1995).
- Monyo, J.H. Rice Breeding and Agronomy. Paper presented at the 1st FAO/SIDA Seminar on Improvements and Plant Scientists in Africa and Near East, FAO, Rome, p.109 – 1189 (1974).
- Kihupi, A.N. Utilization of induced mutants in rice improvement in Tanzania. In: Cereal Protein Improvement, Pages 81-86. International Atomic Energy Agency, Vienna Austria (1984).
- Luzi-Kihupi, A., Zakayo, J.A. Performance of Early Maturing Mutants Derived from 'Supa' Rice (*Oryza sativa* L.) cultivar, *TJAS* **4**(1), 37-43 (2001).
- Kihupi, A.N. Plant Type Improvement of Indigenous Rice Cultivars through Induced Mutations, IAEA-TECDOC-951, pp 45-54, IAEA, Vienna, Austria (1997).
- Maluszynski, M., Micke, A., Donini, B. Genes for semi-dwarfism in rice induced by mutagenesis, In Rice Genetics, IRRI, Manila, Philippines, 729-737 (1987).
- Rutger, J.N, Peterson, M.L., H.U, C.M., Lehman, W.F. Induction of useful short stature and early maturing mutants in Japonica rice (*Oryza sativa* L) cultivars, *Crop Sci.* **16**, 631-635 (1978).
- Mahadevappa, M., Ikehishi, H., Coffman, W.R., Kumara Swamy, S. Improvement of native rices for earliness through induced mutagenesis, *Oryza* **20**(1), 40-46 (1983).
- Singh, M.P., Sinha, O.K., Induced mutagenesis in native rices, Rice Genetics, IRRI, Manila, Philippines pp.719-727 (1986).
- Khush, G.S., Modern varieties-Their real contribution to Food Supply and Equity, *Geo Journal* **35**(3), 275-284 (1995).
- Wang, L.Q. Induced mutations for Crop Improvement in China, A review, In Plant Mutation Breeding for Crop Improvement, I.A.E.A. Vienna, p.9-32 (1991).

Use of Induced Mutations to Adopt Aromatic Rice to Low Country Conditions of Sri Lanka

R Pathirana^{1,3}, T Vitiyala¹ & N S Gunaratne²

Abstract

Two aromatic rice accessions, Au 27789 and IR Basmati were used in mutation breeding by subjecting 12,000 seeds of each variety to γ -ray doses of 200 or 300Gy from a ⁶⁰Co source. Based on agronomic characteristics, 635 M₂ plants were selected and grown as M₃ progenies. Sixty plants were selected from non-irradiated parental varieties using the same criteria, and tested along with mutant plant progenies. Both doses of γ -rays were effective in creating genetic variability for agronomic characteristics, with high heritability values when M₂ parent to M₃ progeny regression-based heritability was compared with selection in non-irradiated control varieties. Three mutant lines with compact plant type, erect and larger flag leaf, compact panicles and acceptable quality recording the highest yield were tested in five locations over four seasons using two recommended cultivars as controls. The mutant line 22/3 with a medium level of aroma recorded more than 2.5 t/ha, higher than the average yield of rice (1.5 -2 t/ha) in low-country wet zone. It has a compact panicle and narrow leaf angle allowing denser planting, which may help further increase the yield. The mutant lines maintained superior kernel length, linear elongation ratio and expansion index, all of which are important characteristics of aromatic long grain rice.

Introduction

Rice occupies 34% (870,000 ha) of the total area of cultivated land in Sri Lanka with 1.8 million families engaged in its cultivation. Sri Lanka currently produces 2.7 million tons of rough rice annually, which satisfies around 95% of the domestic requirement. Rice provides 45% total calorie and 40% total protein requirement of an average Sri Lankan (IRRI 2008). Despite the introduction of semi-dwarf, high-yielding cultivars, rice production in Sri Lanka has stagnated since the mid-1990s. Overproduction in some years has resulted in lower prices and a subsequent decrease in production. The introduction of high quality rice varieties with good export potential was seen as one way of stabilizing market prices by exporting the excess during years of overproduction. Here we report attempts to develop quality aromatic rice suitable for export, with the aims of increasing farmer income and making rice cultivation more profitable.

Materials and Methods

Two accessions, AU 27789 and IR Basmati, selected for good agronomic and quality traits from a collection of aromatic rice germplasm introduced from IRRI, were used in mutation breeding. Seeds (12,000) of each accession were treated with γ -ray doses of 200 or 300Gy from a ⁶⁰Co source. Based on agronomic characteristics, 635 M₂ plants were selected and grown as M₃ progenies. Sixty plants each were selected from non-

irradiated parental varieties using the same criteria. Five random plants from the middle part of each row were used for recording agronomic characters. To compare variation generated by irradiation with natural variation in parent varieties, M₂ parent to M₃ progeny regression-based heritability values were computed. Six of the best mutant lines (28 ING and 39/1 -selected from Au 27789 irradiated with 200Gy Gamma-rays, 22/3, 3/51 and 3/48 – selected from IR Basmati irradiated with 200Gy Gamma-rays and 4/104 a mutant of IR Basmati irradiated with 300Gy Gamma-rays) were selected in the M₃ and tested in a field trial in a randomized complete block design over two seasons. Following these tests, three mutant lines were selected for multi-location testing at five experimental sites in the Matara District: Mapalana, Kotapola, Thihagoda, Komangoda and Gombaddala. Field experiments were conducted using a randomized complete block design with a minimum of three replications using recommended non-aromatic variety BG 379/2 and a new high-yielding non-aromatic cultivar RU 102 as controls. Agronomic and quality traits (Juliano and Perez 1984) including aroma (Bijral and Gupta 1998) of grains were assessed. Means from three samples per plot were used in the analysis of variance, performed separately and for combined seasons, allowing assessment of genotype x environment interaction.

Results and Discussion

Performance of aromatic rice accessions in the Matara District, Sri Lanka

Aromatic rice cultivars introduced from IRRI recorded very low yields. They were tall and susceptible to lodging. Most accessions did not have the agronomic characteristics of modern rice varieties, such as semi-dwarfism, an erect stem with narrow leaf angle, large and erect flag leaf, and compact and dense panicles (**Table 1**). Many accessions were susceptible to rice blast and did not produce any grain. Two accessions, IR Basmati and AU 27789, recorded acceptable yield and good quality and were therefore selected for the mutation-breeding programme (**Table 1**).

Heritability in mutant populations

Mutation breeding was carried out on two selected aromatic accessions, IR Basmati and AU 27789, to improve their adaptability and agronomic performance. Both doses of γ -rays used, 200Gy and 300Gy, created useful genetic variability. This resulted in higher heritability when M₂ parent to M₃ progeny regression-based heritability values were compared with those for selection in non-irradiated (0Gy) control varieties (**Figure 1**). In AU 27789, lower γ -ray dose seemed to induce more useful variation (**Figure 1**).

Field performance and adaptability of mutant lines

The three mutant lines with the highest yield in preliminary experiments (28 ING, 22/3 and 39/1; **Table 2**) were included in multi-location testing. They were more compact than the parent lines and had a larger and more erect flag leaf, compact panicles and acceptable quality (**Table 2**).

Genotype x season interaction for yield in the analysis of variance of data from multi-location testing was not significant. Therefore, the

¹ Department of Agricultural Biology

² Department of Crop Science, Faculty of Agriculture, University of Ruhuna, Kamburupitiya, Sri Lanka

³ New Zealand Institute for Plant & Food Research Limited, Private Bag 11600, Palmerston North, New Zealand

* Corresponding author. E-mail: PathiranaR@crop.cri.nz

Table 1. Performance of aromatic rice accessions introduced from IRRI in Sri Lanka (mean of two seasons of testing at Mapalana Research Farm, Matara District)

Rice material	Leaf angle	Flag leaf angle	Leaf area* (cm ²)	Flag leaf area (cm ²)	Plant height (cm)	Panicle number	Panicle length (cm)	Grain Yield (kg ha ⁻¹)
Aromatic accessions								
Average (range)	43.5 (24-56)	34.6 (15-136)	17.6 (8-21)	15.6 (6-16)	112.5 (96-138)	10.3 (0-21)	21.3 (13-32)	763.7 (0-1323)
IR Bastmati	42.4	38.9	18.6	13.8	114.7	13.0	24.7	1187.4
AU27789	44.3	35.1	17.2	16.1	112.0	9.4	26.4	1213.9
Non-aromatic rice								
BG 379/2	15.2	8.3	24.8	18.4	77.3	6.3	27.2	2875
RU 102	13.8	8.2	27.5	22.3	100.4	4.4	29.0	3541

*Leaf immediately below the flag leaf

Table 2. Yield and growth characteristics of mutants in the preliminary trials (mean of two seasons testing)

Variety/Mutant line	Leaf angle	Flag leaf angle	Leaf area* (cm ²)	Flag leaf area (cm ²)	Plant height (cm)	Panicle number	Panicle length (cm)	Yield (kg/ha)	Aroma
28 ING	40.1 ^a	28.1 ^b	18.1 ^c	17.2 ^b	99.5 ^{ab}	8.9 ^{abc}	23.5 ^{dde}	1661.3 ^{de}	High
39/1	26.1 ^b	20.0 ^c	19.9 ^{bc}	18.4 ^b	82.8 ^{cd}	7.6 ^{bcd}	24.0 ^{cd}	1878.4 ^d	Low
22/3	18.8 ^c	14.0 ^d	19.5 ^{bc}	18.2 ^b	91.6 ^{bc}	7.3 ^{cd}	24.6 ^{bc}	2351.3 ^c	Medium
3/51	41.5 ^a	35.6 ^a	18.4 ^c	17.6 ^b	88.0 ^{bc}	10.7 ^a	21.4 ^e	1497.3 ^{ef}	Low
3/48	44.0 ^a	30.8 ^a	19.4 ^{bc}	15.8 ^b	90.2 ^{bc}	10.0 ^a	22.2 ^{de}	1310.8 ^f	Low
4/104	41.9 ^a	27.9 ^b	17.1 ^c	17.5 ^b	96.9 ^{ab}	9.7 ^{ab}	24.0 ^{cd}	1538.0 ^{ef}	Low
IR Bastmati	42.3 ^a	39.1 ^a	18.4 ^c	14.3 ^c	109.5 ^a	10.4 ^a	23.1 ^{cde}	1216.4 ^g	Medium
AU27789	45.2 ^a	34.6 ^a	17.1 ^c	17.2 ^b	105.2 ^a	10.0 ^a	24.5 ^{bc}	1311.7 ^{fg}	Low
BG379/2	15.8 ^{cd}	8.56 ^e	22.5 ^b	17.6 ^b	75.9 ^d	5.6 ^{de}	26.5 ^{ab}	2928.7 ^b	None
RU102	13.2 ^d	7.9 ^e	28.7 ^a	22.0 ^a	105.3 ^a	4.7 ^a	28.5 ^a	3481.5 ^a	None
CV (%)	9.3	9.5	8.2	10.9	6.7	14.4	4.7	6.5	

Means with the same letter in a column are not significantly different at 0.05 level according to Duncan's New Multiple Range Test.
*Leaf immediately below the flag leaf

Table 3. Average performance of aromatic rice mutants at five locations in the Matara District, Sri Lanka (mean of four seasons)

Variety/ Mutant line	Leaf angle	Flag leaf angle	Leaf area* (cm ²)	Flag leaf area (cm ²)	Plant Height (cm)	Panicle number	Panicle Length (cm)	Yield (kg ha ⁻¹)	Aroma
28 ING	41.3 ^a	28.8 ^a	18.8 ^c	17.4 ^b	99.9 ^a	8.4 ^a	23.4 ^d	1915.0 ^e	High
39/1	25.7 ^b	20.2 ^b	19.0 ^c	18.1 ^b	83.0 ^c	7.6 ^b	23.7 ^{cd}	2121.9 ^d	Low
22/3	19.2 ^c	14.0 ^c	20.3 ^c	18.5 ^b	91.1 ^b	6.7 ^c	24.5 ^c	2575.8 ^c	Medium
BG379/2	15.6 ^d	8.7 ^d	22.6 ^b	18.1 ^b	75.9 ^d	5.3 ^d	26.3 ^b	3187.6 ^b	None
RU102	13.2 ^a	7.7 ^d	28.9 ^a	21.7 ^a	104.0 ^a	4.5 ^d	28.2 ^a	3687.6 ^a	None
CV %	10.7	9.5	10.6	9.6	6.3	15.1	5.0	7.1	

Means with the same letter are not significantly different at 0.05 level according to Duncan's New Multiple Range Test.
*Leaf immediately below the flag leaf
Quality of aromatic rice mutant lines

Table 4. Kernel characteristics of aromatic lines compared with standard varieties.

Variety	Kernel Length (mm)	Kernel Breadth (mm)	L/B Ratio	Length after cooking (mm)	Breadth after cooking (mm)	Linear Elongation Ratio	Breadth-wise Expansion Ratio	Expansion index
28 ING	7.93 ^a	1.77 ^c	4.49 ^a	10.73 ^a	2.00 ^c	1.39 ^b	1.12 ^b	1.2 ^a
39/1	8.12 ^a	1.98 ^b	4.10 ^b	10.94 ^a	2.21 ^b	1.35 ^b	1.12 ^b	1.21 ^a
22/3	7.01 ^b	1.72 ^c	4.08 ^b	10.04 ^b	1.97 ^c	1.48 ^a	1.13 ^b	1.25 ^a
BG 379/2	5.57 ^c	2.40 ^a	2.32 ^c	6.21 ^c	2.83 ^a	1.08 ^c	1.16 ^a	0.95 ^b
RU 102	4.16 ^d	2.47 ^a	1.69 ^d	4.50 ^d	2.89 ^a	1.06 ^c	1.18 ^a	0.93 ^b
CV%	4.70	4.18	5.89	4.39	4.06	3.03	1.79	6.28

Means with the same letter in a column are not significantly different at 0.05 level according to Duncan's New Multiple Range Test.

data of four seasons was combined for statistical analysis and the results are presented in **Figure 2** and **Table 3**. Separate and combined analysis of data from the five locations gave similar results and trends for all characters showing that these characters are expressed consistently over seasons and are highly genotype dependent.

Although the yields of mutant lines were significantly lower than the standard cultivars, the line 22/3 with a medium level of aroma recorded mean grain yield of more than 2.5 t ha⁻¹ (**Table 3**), which is much higher than the average yield of rice in the Matara District, which fluctuates between 1.5 -2 t ha⁻¹ (Weerasinghe and Lexa 1988; Pathirana and Chandrasiri 1991). It has narrow flag leaf and leaf angle allowing denser planting, which may help further increase the yield. Panicle is more compact than in the parent accession and in the other two mutant lines.

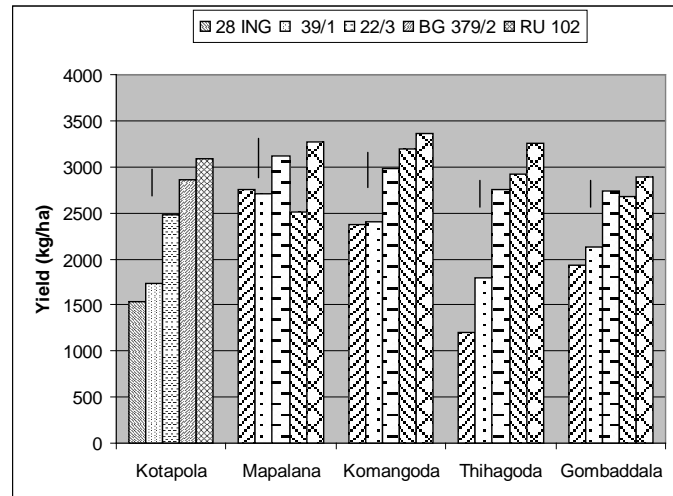

Figure 1 Heritability of agronomic characters based on M₂ parent to M₃ progeny regression compared with selection in non-irradiated plants in two aromatic accessions.

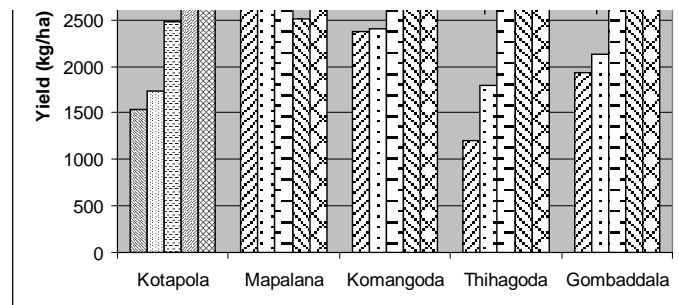

Figure 2 Yield performance of three mutant and standard varieties at five locations in the Matara District, Sri Lanka (mean of four seasons, bars represent LSD).

The mutant lines maintained the quality of parent lines, recording highest kernel length, linear elongation ratio and expansion index (Table 4), all of which are important characteristics of aromatic long grain rice (Sharma 2002). High milling returns and good cooking quality are often associated with aromatic or scented rice. Grain elongation at cooking is a special characteristic of several high grain quality varieties such as Basmati 370 and Nga Kywe. Such grades fetch approximately two times the price of average grade rice in international markets (FAO 2002). Mutant line 22/3 recorded a linear elongation ratio similar to Basmati rice from Pakistan (Sakila, *et al.*1999). Our surveys in Colombo, Matara and Galle revealed that high quality aromatic Basmati rice is almost three

times the price of white rice produced from widely cultivated Sri Lankan varieties. Thus cultivation of these lines, 22/3 in particular, will be more profitable. Investigation and implementation of agronomic practices to optimize the yield and quality of new mutant lines will help increase the profitability of cultivation. Their further improvement may be possible through hybridization among mutants.

ACKNOWLEDGEMENTS

This work was funded by the International Atomic Energy Agency, Vienna (grant RC 7646 RB) and the National Science Foundation of Sri Lanka (grant RG/AG/99/01).

BIBLIOGRAPHY

1. Bijral JS and Gupta BB 1998 Inheritance of aroma in Saanwal Basmati. Indian J. Genet. Plant Breeding. 58: 117-119.
2. FAO 2002 Food Outlook, Food and Agriculture Organisation of the United Nations. No.4 - October 2002 p.22.
3. IRRI. 2008 <http://www.knowledgebank.irri.org/regionalSites/sriLanka/home.html> (downloaded on 17th September 2008)
4. Juliano BA and Perez CM 1984 Results of a collaborative test on the measurement of grain elongation of milled rice during cooking. J. Cereal Sci. 2: 281-292.
5. Pathirana R and Chandrasiri PAN 1991 Evaluation of rice genotypes grown on the acid soils of the Nilwala River Basin, southern Sri Lanka. In: Deturck P and Ponnampereuma FN (Eds) Rice Production on Acid Soils of the Tropics. Institute of Fundamental Studies, Kandy, Sri Lanka. Pp.265-272.
6. Sakila M, Ibrahim SM, Anandakumar CR, Backiyarani S and Bastian D 1999 Grain quality characteristics of aromatic and non-aromatic rice cultivars. International Rice Res. Notes. 24: 17-18.
7. Sharma N 2002 Quality characteristics of non-aromatic and aromatic rice (*Oryza sativa*) varieties of Punjab. Indian J Agric. Sci. 72: 72 (7): 408-410.
8. Weerasinghe KDN and Lexa JP 1988 The improvement of rice cropping systems in Kiralakele, Nilwala Ganga Flood Protection Scheme. Sri Lanka-French Agriculture Development Project, Faculty of Agriculture, University of Ruhuna, Kamburupitiya. Sri Lanka.

Characterization of Pre-breeding Genetic Stocks of Urdbean (*Vigna mungo* L. Hepper) Induced Through Mutagenesis

V Kumar^{1*}, A K Sharma¹, V P Singh² & M Kumar¹

Abstract

Pre-breeding genetic stocks using different doses of EMS, Gamma-rays and combination of both (EMS and Gamma-rays) were induced in two urdbean cultivars viz., PU-19 (Pant Urd-19) and PU-30 (Pant Urd-30). Out of a total 14 of macro mutations selected from the different treatments of the mutagens in PU-19, narrow leaf mutant exhibited significantly a higher yield/plant as compared to the parent and some other mutants viz., non-hairy, tall, and tendriller showed at par grain yield. All the seed and pod color double mutations selected from the PU-30 showed significantly higher yield. Such breeding stocks can be used for the further genetic enhancement of this crop.

Introduction

Black gram (*Vigna mungo* L. Hepper), popularly known as urdbean, urid or mash is an important self-pollinating diploid grain legume and belongs to the family Leguminosae and subfamily Papilionaceae. It is an important food legume crop of the Indian subcontinent. Genetic enhancement for yield, synchronization, and tolerance to major biotic and abiotic stresses is a major concern due to comparatively less genetic diversity in this crop. Since genetic variability is a prerequisite for any successful breeding programme, and the creation and management of such induced variability becomes a central base for the improvement of any crop species. Creation of genetic variability followed by screening and selection of the best genotype is a major target for this crop. Mutation is considered as one of the easy, rapid and effective tools of crop improvement. Spontaneous mutation cannot be expected to serve the cause of crop improvement effectively due to its very low i.e., 10⁻⁷-10⁻⁹. Induced mutations may be induced using treatment with certain physical (Gamma-rays) or chemical mutagens. Selection of macro mutation for different contrasting traits can be used as a variety or as a parent for the bringing of desirable traits into the otherwise well-adapted cultivars. Induction of the useful macro mutations for increasing genetic diversity and utilization of such trait-specific genetic stock for further crop improvement would certainly be useful.

Description of scenario selection procedures

Independent initiating event methodology

Four hundred healthy, pure, uniform and dry (9.5% moisture) seeds of two cultivars viz., PU-19 and PU-30 of urdbean were used for each treatment of Gamma-rays, EMS and a combination of both. Seeds were treated with ⁶⁰Co Gamma-rays (10, 20, 30 and 40 kR) at I.A.R.I., New Delhi. Pre-soaked seeds were treated with (0.2, 0.4, 0.6 and 0.8 %) of freshly prepared aqueous solution of EMS in phosphate buffer (pH 7.5) for 8 hours. For combination treatments, four hundred seeds for each treatment were treated with Gamma-rays first and then with 0.2% EMS

solution. Treated seeds with EMS were thoroughly washed in running water for four hours to remove the residual effect of the chemical and then dried on blotting paper. Three hundred and fifty seeds of each treatment were sown in the M₁ generation at the experimental plot of Agricultural Research Farm, Banaras Hindu University, Varanasi during the summer of 2001. The M₂ generation was raised during *Kharif*, 2001 following plant to progeny row method. The M₁ seeds were space planted (35x15 cm) in the randomized block design with three replications to raise the M₂ generation during *Kharif*, 2001. The population was screened for macro-mutations.

The macro-mutants selected in the M₂ generation were advanced to the M₃ generation following plant to progeny during the summer of 2002, in a randomized block design with three replications to study their breeding behavior and performance nearly homozygous promising mutant lines of for yield and yield traits. The observations made on the normal looking plants, selected in the M₂ generation for micro-mutation were advanced to the M₃ generation. The experiment was conducted in randomized block design with three replications. The data on yield and yield traits was recorded as mentioned in the M₂ generation from 15 randomly selected plants from each replication. Soil of the experimental site was sandy loam to clay loam types with pH-7.9, 0.6 percent organic carbon of the field. The data obtained for different yield and yield attributing traits under study were subjected to statistical analysis as suggested by [2].

Confinement in the near field

The broad spectrum of macro or viable mutations was (plant with altered phenotype) identified in M₂ generations in both the cultivars. Out of the all the all the mutations with altered phenotypes 31 types of macro mutations were identified in PU-19 whereas, 35 types of macro mutations were identified in PU-30. The macro mutations isolated in the M₂ generation grew in the M₃ generation following the plant to progeny row for their characterization. Many true breeding mutants having distinct morphological feature (s) were isolated in the M₃ generation. Out of the total number of viable macro mutations identified in the M₂ generation, 13 true breeding mutant lines from each cultivar were selected and characterized in the M₃ generation. The main features and the treatment of mutagen against the mutants isolated from PU-19 and PU-30 are as follows and the mean performance of all mutant lines are presented in **Tables 1 and 2**, respectively.

True breeding mutant lines of cv. Pant Urd-19

Non-hairy: This mutant line was isolated from the combination treatment of EMS and Gamma-rays 30kR+0.2%, pods are non-hairy, high-yielding, moderately susceptible to the MYMV, but resistant to CLS.

Tall: Tall mutant is 10 cm taller (44.40 cm) in comparison to the parent, and was isolated from the 0.6% EMS treatment, has a higher number of pods and branches per plant, resistant to MYMV and CLS.

Tendriller: It was isolated from the combination treatment 20kR+0.2%, tall, high-yielding, higher pod length, resistant to the MYMV and CLS.

¹ Directorate of Research, Sardar Vallabh Bhai Patel University of Ag. & Tech. Meerut, India

² Department of Genetics and Plant Breeding, Institute of Agricultural Sciences, Banaras Hindu University, Varanasi-2210 05 (U.P.), India.

* Corresponding author. E-mail: vipinch1@yahoo.co.in

Short pod: Short pod mutant was isolated from the 10kR treatment of Gamma-rays, medium height, small pod (3.68 cm), low-yielding and resistant to the MYMV and CLS.

Late: Late maturity as well as late flowering, isolated from 40kR treatment of Gamma-rays, fewer pods per plant, more branches per plant, low-yielding, higher 100-seed weight, moderately susceptible to the MYMV but resistant to CLS.

Oval leaf: Leaves were oval shaped, isolated from 20kR dose of Gamma-rays, dwarf, less number of pods and branches per plant, comparatively early in maturity (87 days), resistant to the MYMV and CLS.

Narrow leaf: Leaves were narrow and comparatively long, high number of pods and number of seeds per pod, identified from the 20kR+0.2% combination treatment, resistant to the MYMV and CLS.

Bunchy pod: The pods formed a bunch, isolated from the 0.4% treatment of EMS, larger number of pods per plant, dwarf, high 100-seed weight, less infestation of pod borer, resistant to the MYMV and CLS.

Small seeded: Seeds are small in size, low 100-seed weight, isolated from the 30kR treatment of Gamma-rays, low-yielding, comparatively more infestation of pod borer, resistant to the MYMV and CLS.

Flat seeded: Shape of the seed was flat, isolated from the 20kR+0.2% combination treatment, medium height, medium yielding, comparatively more infestation of pod borer, resistant to the MYMV and CLS.

Early: Matured in 81.45 days, in isolated form with 0.8% dose of EMS, low yielding, comparatively more infestation of pod borer, resistant to the MYMV and CLS.

Pigmented stem: Stem was violet to red in color before maturity and turned to black at maturity, isolated from the 30kR treatment of Gamma-rays, more number of seeds per plant, medium-yielding, comparatively less infestation of pod borer, resistant to the MYMV and CLS.

Long petiole: Length of petiole was more as compared to the parent, isolated from the 10kR+0.2% combination treatment, medium yielding, comparatively more infestation of pod borer, resistant to the MYMV and CLS.

True breeding mutant lines of cv. Pant Urd-30

Seed mutnat-1: This mutant was isolated from Gamma-rays treatment 30kR, early maturing as compared to the control, golden (shining) color seed with brown pod, high yielding, less infestation of pod borer resistant to CLS and MYMV.

Seed mutnat-2: Yellow (without shining) seed with brown pod, isolated from the 20kR+0.2% combination treatment, more number of pods per plant, high yielding, higher seed weight, resistant to CLS and MYMV.

Seed mutnat-3: Isolated from the 30kR+0.2% combination treatment, seeds were shining black color with brown pod, high yielding, resistant to CLS and MYMV, high 100 seed weight and more number of pods per plant.

Seed mutnat-4: Seeds were shining spotted (yellow with black) with brown pod, isolated from the 30kR+0.2% combination treatment, high yielding, resistant to CLS and MYMV.

Seed mutnat-5: Brown pods, black rough seeds, tall and medium yielding, resistant to CLS and MYMV, isolated from the combination treatment 20kR+0.2%.

Seed mutant-6: Black pods, golden (shining) seeds, dwarf and low yielding, resistant to CLS and MYMV, isolated from the Gamma-rays treatment 30kR.

Seed mutant-7: This mutant was isolated from the 6% treatment of EMS, black pods with spotted shining seeds, tall, and medium yielding, resistant to CLS and MYMV.

Crinkled leaf: Leaves were small and crinkled, isolated from the 0.6% treatment of EMS, medium yielding, comparatively more infestation of pod borer, resistant to the MYMV and CLS.

Bushy: Dwarf with higher number of branches per plant, isolated

from the 40kR treatment of Gamma-rays, low yielding, more infestation of pod borer, resistant to the MYMV and CLS.

Bold seeded: Isolated from the combination treatment 20kR+0.2%, bold seed, higher seed weight (5.0g) and grain yield per plant, medium yielding, medium height, less infestation of pod borer, resistant to the MYMV and CLS.

Tall: Plant height was 6-7 cm more than the parent, isolated from the 30kR treatment of Gamma-rays, yield per plant was almost equal to the parent, less number of the pods per plant, less infestation of pod borer, resistant to the MYMV and CLS.

Early: This mutant line matured 16 days early in comparison to the parent, it was isolated from the 0.6% treatment of EMS, low yielding, medium height, less number of pods per plant, less number of the pods per plant, comparatively more infestation of pod borer, resistant to the MYMV and CLS.

Dwarf: Plant height was 14 cm less as compared to the parent, isolated from the 0.8% treatment of EMS, high yielding, high seed weight, less number of the pods per plant, less infestation of pod borer, resistant to the MYMV and CLS.

Data perusal from the **Table 1** revealed that out of the total 14 macro mutations selected from the different treatments of the mutagens in PU-19, narrow leaf mutant exhibited significantly higher grain yield per plant (6.24g), compared to the parent and some other mutants viz., non-hairy, tall, and tendriller showed at par grain yield. The late maturing mutant exhibited maximum plant height (48.70 cm) and maximum number of branches per plant (4.82). Almost all the mutants showed resistance to CLS and MYMV, except non-hairy and late mutants, which were moderately susceptible against MYMV. Although the late maturing mutant exhibited a much smaller number of pods per plant as compared to the parent (PU-19), this mutant can be used for forage and green manuring purposes. Early maturing mutants take only 81 days to mature, which is significantly less than the parent PU-19. Several workers have reported tall, dwarf, bushy and tendriller types of mutants (13, 11, 6). Narrow, oval, broad and crinkled types were also reported in different pulse crop following mutagenic treatments [5, 7]. Leaf abnormalities were attributed to the chromosomal breakage, disturbed auxin synthesis, disruption of mineral metabolism and accumulation of free amino acids [4].

Data presented in the **Table 2** revealed that macro mutations identified in PU-30, bunchy pod mutant exhibited less infestation of MYMV and pod borer compared to the parent. All seed and pod color mutations showed a significantly higher yield. All seed and pod color mutations have been submitted to the National Gene Bank, NBPGR, New Delhi for their registration and out of these Brown pod with Yellow Rough Seeded mutant has been registered [9]. The maximum number of pods per plant (35.32), was exhibited by the Seed mutant -4 followed by seed Mutant-3 (33.06). Such high-yielding with shining seed color mutations can be released as a variety [14]. Male sterility results in malformation of male reproductive organs caused by gene transformation of stamens into carpel-like organs. Chemical mutagens probably induce sterility due to increased sensitization of the embryo and seeds as a result of presoaking and decreased intrasomatic selection. Male sterility may be attributed to gene mutation or deletion [16]. The anthocyanine pigmented mutants were isolated in the M_3 generation which had pinkish color stems and branches, but it turned black at maturity. Such a type of mutant has been reported by [10, 11, 15]. The macro mutations of seed and pod color were induced in the M_3 generation. Such seed mutations for different seed color were reported in pulse crops, for example, buff and black in arhar [1], yellow in soybean [16] and dull green to shining green [3] and golden-yellow [12] in mungbean. [12] suggested that golden yellow testa mutant was likely to involve a single gene but the simultaneous variations for yield and other morphological characters indicate a gross change or perhaps a very closely linked group of genes [8].



Figure 1 Normal pods with short and non-hairy pod mutants.



Figure 2 Normal with brown color and non-hairy bunchy pod mutants.

Table 1: Mean value for yield and traits of some induced mutant lines of Pant U 19 in the M₃ generation

Mutant line	Days to Flowering	Days to maturity	Plant height (cm)	No. Of branches plant ⁻¹	No. pods plant ⁻¹	Pod length (cm)	No. of seed pod ⁻¹	100 seed weight	Grain yield plant ⁻¹
Non-hairy	37.50	92.52	38.93	4.12	26.12	4.66	5.02	4.48*	5.54*
Tall	40.00	96.66	44.60*	4.70*	26.23	5.16*	5.32*	4.41	5.50
Tendriller	41.20	94.43	45.90*	4.52	25.30	5.43*	5.29*	4.24	5.42
Short Podded	37.24	90.97	36.73	3.27*	18.87*	3.68*	4.25	4.25	4.64
Late Maturing	48.56*	116.23*	48.70*	4.82	19.66*	4.41	5.04	4.40	5.27
Oval Leaf	37.75	87.50	28.10	3.43	19.66*	4.55	5.32*	4.23	5.35
Narrow Leaf	36.88	93.60	30.23	3.61	26.51	4.60	5.56*	4.79*	6.24*
Bunchy Podded	40.77	95.43	26.70*	3.45	30.75*	4.54	4.46	4.52*	5.36
Small Seeded	38.60	88.81	32.55	4.33	24.41	4.57	4.73	3.73	5.28
Flat Seeded	40.23	92.54	30.67	3.95	20.56	4.41	4.56	3.88	5.33
Early Maturing	34.56*	81.45	25.34	3.86	22.45	4.08	4.50	3.76	4.95
Pigmented Stem	37.22	90.37	30.23	3.67*	24.70	4.51	5.06	4.18	5.40
Long Petiole	41.45	91.33	28.45	4.30	20.54	3.76	4.11	3.79*	5.29
Parent (Pant U 19)	39.17	88.31	33.18	3.94	28.03	4.53	5.38	4.13	5.50
SEm±	1.04	1.45	1.11	0.12	0.67	0.065	0.340	0.078	0.231
LSD (5%)	2.19	3.05	2.33	0.26	1.41	0.137	0.714	0.164	0.485

*Indicates lowest and highest values

Table 2. Mean value for yield and traits of some induced mutant lines of Pant U 30 in the M₃ generation.

Mutant line	Days to Flowering	Days to maturity	Plant height (cm)	No. Of branches plant ⁻¹	No. pods plant ⁻¹	Pod length (cm)	No. of seed pod ⁻¹	100 seed weight	Grain yield plant ⁻¹
Seed mutant-1	45.81*	88.67	36.74	3.45	35.31*	5.11*	5.13*	4.79	7.26*
Seed mutant-2	43.10	94.66	34.25	3.20	30.34*	4.50	5.00*	5.03*	6.958
Seed mutant-3	41.48	86.34	41.06*	4.00	33.06*	4.88*	5.20*	4.90*	7.45*
Seed mutant-4	40.23	85.33*	35.13*	3.44	35.32*	4.80	4.75	4.88	7.23*
Seed mutant-5	37.80	96.66	40.48	3.37	28.06	4.26	4.61	4.65	5.74
Seed mutant-6	36.55*	88.17	34.44	4.04*	26.90	3.70	4.87	3.76*	4.50
Seed mutant-7	43.43	90.30	34.35	3.74	27.97	3.70	4.34	4.63	5.32
Crinkled Leaf	40.57	93.43	35.658	3.46	20.32	3.57	4.41	3.80	4.58
Bushy	43.70	99.65	33.53	4.54*	23.65	3.86	4.36	3.86	4.41
Bold Seeded	44.85	95.77	35.41	3.28	18.76*	3.58	4.25	5.00*	4.95
Tall	40.33	97.67	44.54*	3.43	20.43	4.12	4.42	4.25	4.81
Dwarf	37.09	87.79	24.52*	4.00	25.32*	4.34	4.78	4.50	6.44*
Early Maturing	35.69	83.80*	30.43	3.56	22.87	4.00	4.33	4.13	4.23
Parent (Pant U 30)	42.79	92.07	37.49	4.15	26.05	3.68	4.74	3.87	4.88
SEm+	1.04	0.89	0.99	0.23	0.65	0.32	0.09	0.13	0.19
LSD (5%)	2.19	1.87	2.08	0.48	1.37	0.68	0.18	0.27	0.40

*Indicates lowest and highest values

BIBLIOGRAPHY

1. Ali Khain, W.M. And Veeraswamy, R. Mutations induced in redgram (*Cajanus cajan* L. Millsp.) by gamma radiation and EMS. *Rad. Bot.* **14**, 237-242 (1974).
2. Gomez, A.K., Gomez, A.A. Statistical procedures for agricultural research. 2nd edition. John Wiley & Sons, New York (1984).
3. Grover, I.S., Tejpal, S.K. Induced mutations in greengram. *Genet. Pol.* **20**, 529-540 (1979).
4. Gunke, J.E., Sparrow, A.H. Ionizing radiations: biochemical, physiological and morphological aspects of their effect on plants. In: W. Ruhland (ed.). *Encyclopedia of Plant Physiology*, Springer, Berlin. **16**, 555-611 (1961).
5. Jana, M.K. X-ray induced mutations of *Phaseolus mungo* L. chlorophyll mutations. *Cytologia.* **16**, 685-692 (1963).
6. Khan, M.N., Tak, G.M. Induced mutations in blackgram (*Vigna mungo* L. Hepper). In: Proceedings of Department of Atomic Energy-BRNS Symposium, Mumbai, 131-137 (2000).
7. Rao, S.A., Jana, M.K. Leaf mutations induced by X- rays in blackgram (*Phaseolus mungo* L.). *Mutation Breed. Newslett.* **3**, 11 (1976).
8. SAINI, R.G., MINOCHA, J.L. AND SINGH, A., Sterile mutant of *Phaseolus aureus*. *Science Cul.* **40** 1 (1974) 37-38.
9. Sharma, A.K., Singh, V.P., Sarma, M.K. Induced mutations for seed and pod color in urdbean (*Vigna mungo* L. Hepper). *Indian J. Genet.* (In Press) (2008).
10. Singh, V.P., Yadav, R.D.S. Induced macro and micro mutations in mungbean (*Vigna radiate* L. In: Proc. Symp. On Crop Improvement, Ludhiana, India (eds. Gill et al.). *Crop Improvement Society of India*, 115-116 (1987).
11. Singh, V.P. Singh, Man, Lal, J.P. Mutagenic effects of Gamma-rays and EMS on frequency and spectrum of chlorophyll and macromutations in urdbean (*Vigna mungo* L. Hepper). *Indian J. Genet.* **59**(2), 203-210 (1999).
12. Singh, V.P., Yadav, R.D.S., Singh, R.M., Singh, B.D., Singh, R.B. Note on a golden seed coat color mutant of mungbean (*Vigna radiate* L. Wilczek) induced by gamma radiation. *Legume Res.* **5**(2), 111-114 (1982).
13. Summaggon, R. Mutants derived from irradiated mungbean cv. Manyar. *TVIS News, Taiwan*, **2**(2), 6 (1987).
14. Swarup, V., Gill, H.S. X ray induced mutations in Frenchbean. *Indian J. Genet.* **28**(1), 44-58 (1968).
15. Tickoo, J.L., Spectrum and frequency of induced macro-mutations in mungbean. First symposium on Crop Improvement, Feb. 23-27, (eds, K.S. Gill, A.S. Khera, M.S. Verma and K.S. Brans) Ludhiana. *Crop Imp. Soc. India*, 198-202 (1987).
16. Tyagi, B.S., Gupta, P.K. Induced macro-mutations in lentil. *LENS News!* **18**(1), 3-7 (1991).

Development of High Yielding, Late Maturing Kenaf (*Hibiscus cannabinus*) Using Gamma Irradiation

M O Balogun*, S R Akande, J A Raji, B A Ogunbodede, G O Agbaje & O O Adeyeye

Abstract

Two mutants of Kenaf (*Hibiscus cannabinus*) derived from gamma irradiation of Cuba 108 (Mutant 1) and Tainung-1 (Mutant 2), their parents and two landraces were evaluated for maturity period and fiber yield traits in the forest, derived and southern Guinea savannah agro-ecologies of southwest Nigeria. Mutant 2 was consistently late maturing across locations with an average of 80 days compared to 71 in the parent. Fiber yield and maturity period were highest in forest and lowest in Southern Guinea savannah agro-ecologies due to photoperiod and rainfall differences. Mutant 2 was most stable, and had the highest mean value of 26,158kg/ha for fiber yield followed by 17,611kg/ha in Mutant 1. Mutant 2 is suspected to be photo-insensitive and recommended for equatorial climates.

Introduction

Kenaf is an important fiber plant that alleviates global warming by absorbing carbon dioxide gases due to its rapid growth rate. However, Africa produces only 2.91% of the global production [1]. This is due in part, to photosensitivity of most of the varieties.

Photosensitive varieties of Kenaf initiate flowering when day length reduces to 12.5 hours, and are suited for countries above the tropics. In contrast, these cultivars flower very early at latitude 0° to 10° N or S, where day length is more uniform from June to September, causing a reduction in vegetative growth and low fiber yields. Photo-insensitive cultivars are therefore preferred since they flower late, or when they flower early their vegetative growth is not significantly reduced [2]. To develop varieties that are adapted to Nigerian agro-ecologies, induced mutagenesis was used to create genetic variability for maturity period and fiber yield in Kenaf.

Methods

Dry seeds of two varieties of Kenaf were exposed to Cobalt⁶⁰ source of Gamma-ray at doses of 200 and 400Gy and the M₂ population was screened for mutants in terms of maturity period and fiber yield. Cuba 108 was irradiated with 200Gy (Mutant 1) and Tainung-1 irradiated with 400Gy (Mutant 2) were mostly high yielding and late maturing, respectively, and therefore selected. The selections were planted up to the M₃ generation when they became stable. To formulate recommendations for areas of optimal cultivar adaptation [3, 4], the selections were planted in multi-locational trials alongside the parents and two local varieties at Ikenne, Ilora and Ballah corresponding to forest, derived and southern Guinea savannah agro-ecologies respectively in southwest Nigeria.

Results and Discussion

Mutant 2 was consistently late maturing in the three locations (Fig. 1) compared to other genotypes, except for Mutant 1 at Ikenne, which

matured two days later. Maturity periods varied with location in other genotypes. The average maturity period for Mutant 1 was 80 days, compared to 71 in the parent.

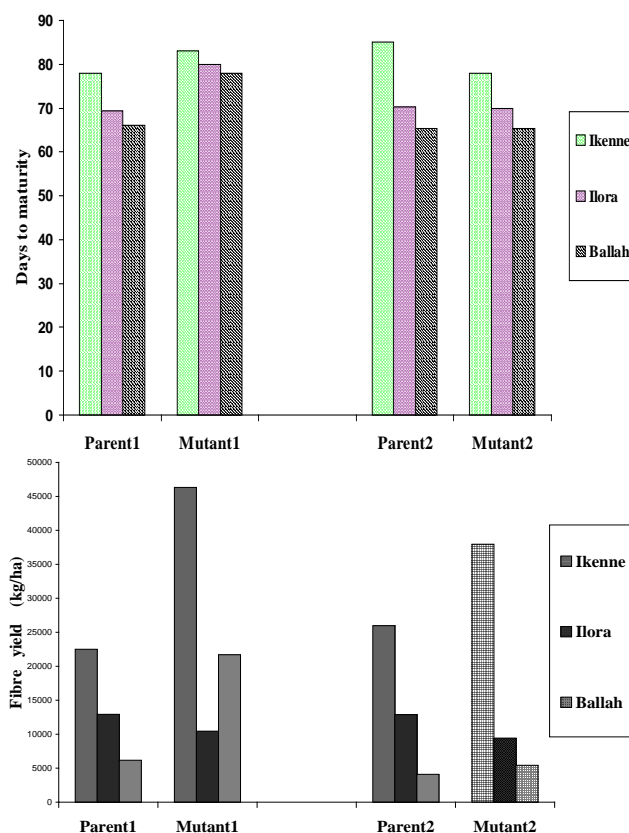

Figure 1 Maturity period and fiber yield in two mutants of Kenaf and their parents in three Nigerian agro-ecologies.

Although at flowering, Mutant 2 plants were taller than other genotypes in Ikenne (Table 1), they were shorter than other genotypes in Ilora and Ballah despite longer days to maturity at these locations. Mutant 2 had the highest percentage gain in height after flowering, 293.08% compared to 90.13% in the parent line (Table 1).

The highest fiber yield was recorded in Ikenne across genotypes (Table 1). At Ikenne, both mutants had higher fiber yields than other genotypes. Mutant 2 had the highest value of 46,321kg/ha (Figure 1), followed by Mutant 1 with 37,966.5kg/ha. These were in comparison with 22,498.7kg/ha in Tainung-1 (Mutant 2 parent) and 25,978.3kg/ha in Cuba 108 (Mutant 1 parent). One of the landraces (Local 35) had the lowest fiber yield of 17,427.67kg/ha.

Obafemi Awolowo University, Institute of Agricultural Research and Training, Moor Plantation, P.M.B. 5029, Ibadan, Nigeria

* Corresponding author. E-mail: kemtoy2003@yahoo.com.

Table 1. Mean vegetative growth traits and fiber yield of Kenaf genotypes grown at forest, derived from southern Guinea savannah agro-ecologies of Nigeria

Genotypes/Trait	Agro-ecologies			Mean (Genotypes)
	Ikenne	Ilorra	Ballah	
Height at flowering (cm)				
Mutant 1	182.92b	152.67a	77.00a	137.53A
8B	168.17c	148.00a	69.17ab	128.44BC
Tainung-1 (Parent 2)	145.67d	154.67a	73.00a	124.44CD
Cuba 108 (Parent 1)	147.92d	142.00a	72.00ab	120.64DE
Local35	146.83d	143.67a	59.27b	116.59E
Mutant 2	239.92a	123.33b	40.33c	134.53AB
Mean (Agro-ecologies)	171.90A	144.06B	65.13C	
Error mean square	63.77			
Gain in Height after flowering (%)				
Mutant 1	9.55a	27.46a	74.54b	37.18B
8B	10.12a	24.29a	69.92b	34.77B
Tainung-1 (Parent 2)	13.63a	13.97a	90.13b	39.24B
Cuba 108 (Parent 1)	12.69a	37.51a	62.63b	37.61B
Local35	19.47a	14.92a	103.42b	45.94B
Mutant 2	4.82a	33.12a	293.08a	110.34A
Mean (Agro-ecologies)	11.71C	25.21B	115.62A	
Error mean square	779.56			

by the same upper case letters are not significantly different at $p=0.05$.

Highest fiber yields were recorded in Ikenne for the Kenaf genotypes evaluated in this study. Kenaf fiber yields have been reported to be highest in regions with long growing seasons and abundant moisture [5], which are characteristic of Ikenne.

Also, Kenaf is a short-day annual that remains vegetative until the number of daylight hours fall below 12.5 hours, when flowering occurs [2, 6]. Ballah, Ilora and Ikenne are located on 13, 7 and 6 degrees latitude respectively, and this is associated with an increasingly wetter climate and later shortening of day length (Fig. 2). The growing season is longest at Ikenne and shortest at Ballah.

Low fiber yield was recorded in Mutant 2 at Ballah and Ilora as it was yet to reach its maximum vegetative growth when it flowered. This was as a result of water stress due to no rainfall in November at Ballah (Fig. 2). Vegetative growth was therefore retarded, but resumed with sparse rain in December, causing its high percentage gain in height after flowering at this location. Also, day length decreased soon after planting at Ballah and Ilora, making the plants (especially the relatively photosensitive genotypes) flower earlier to produce seeds before the dry season. The initiation of flowering is associated with reduced vegetative growth, and in turn, low fiber yield. Planting should therefore be done earliest in Ballah, followed by Ilora and Ikenne to allow for ample vegetative growth and high fiber yields before cessation of rains.

Conclusion

The consistently late maturing, high yielding Mutant 2 is recommended for the three locations, while Mutant 1 will also yield well at Ikenne. Fiber yield will be optimum when planted early in the growing season. Induced mutagenesis was successfully used to develop high-yielding genotypes of Kenaf adapted for specific climates (Table 2). This could be a very useful tool for creating genetic diversity that will cope with global climate change in a sustainable way.

BIBLIOGRAPHY

1. FAO. The production and consumption of Kenaf in China. ESC-Fibers Consultation no. 03/6 (2003).
2. Balogun, M.O., Raji, J.A., Akande, S.R., Ogunbodede, B.A. Variations in Photo- and thermal-sensitivities among local, improved and exotic Kenaf accessions in Nigeria. *Journal of Food, Agriculture and Environment* 5(1), 385-388. (Finland) (2007).
3. Jackson P., Robertson, M., Cooper, M., Hammer, G.L. The role of physiological understanding in Plant Breeding: From breeding perspective. *Field Crops Research* 49, 11-37 (1998).
4. Charles, L. Trends in New Crops and New Use, ASHS Press, Alex, VA (2002).
5. Liu, A.M. Making pulp and paper from Kenaf. <http://www.chinaconsultinginc.com/paper-pulp.htm> (2003).
6. Dempsey, J.M. Fiber Crops. University of Florida Press, Gainesville, p.203-304 (1975).

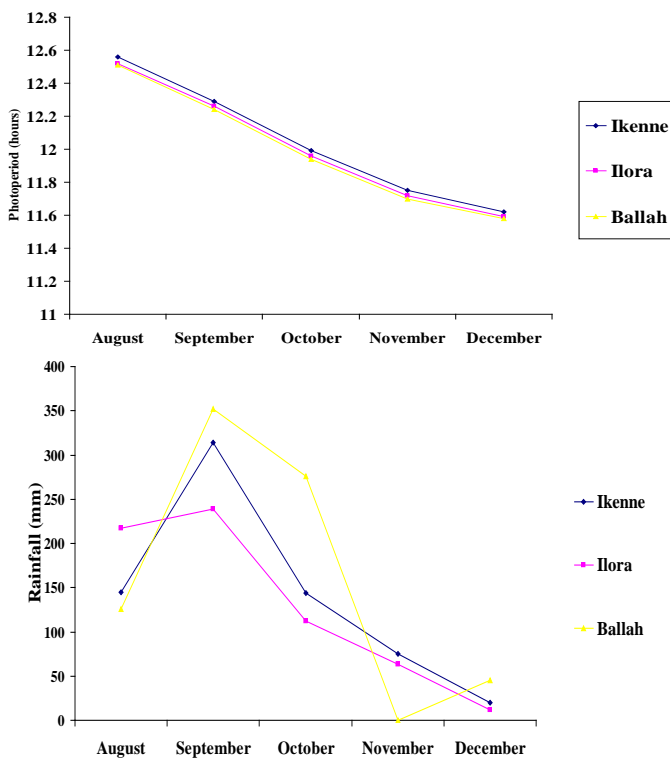

Figure 2 Rainfall distribution and rainfall patterns at the three agro-ecologies during the growing season.

Mean in each column followed by the same lower case letters are not significantly different at $p=0.05$. Genotype and location means followed

PLENARY SESSION 2

Induced Mutations in the Genomics Era: New Opportunities and Challenges

Functional Genomic Analysis of Systemic Cell Division Regulation in Legumes

P M Gresshoff^{*}, A Indrasumunar, A Miyahara, S Nontachaiyapoom, B Biswas, Y-H Lin, M-H Lin, D Reid, D Callahan³, R Capon¹, H Zhang¹, Q Jiang, T Hirani, B Kobe¹, A Men², P Scott, A Kereszt, M Miyagi, D Li, P-K Chan, U Roessner³, M A Djordjevic⁴, M Kinkema & B Ferguson

Abstract

Legumes develop root nodules from pluripotent stem cells in the root pericycle in response to mitogenic activation by a decorated chitin-like nodulation factor synthesized in *Rhizobium* bacteria. The soybean genes encoding the receptor for such signals were cloned using map-based cloning approaches. Pluripotent cells in the root pericycle and the outer or inner cortex undergo repeated cell divisions to initiate a composite nodule primordium that develops to a functional nitrogen-fixing nodule. The process itself is autoregulated, leading to the characteristic nodulation of the upper root system. Autoregulation of nodulation (AON) in all legumes is controlled in part by a leucine-rich repeat receptor kinase gene (*GmNARK*). Mutations of *GmNARK*, and its other legume orthologues, result in abundant nodulation caused by the loss of a yet-undefined negative nodulation repressor system. AON receptor kinases are involved in perception of a long distance, root-derived signal, to negatively control nodule proliferation. *GmNARK* and *LjHARI* are expressed in phloem parenchyma. *GmNARK* kinase domain interacts with Kinase Associated Protein Phosphatase (KAPP). *NARK* gene expression did not mirror biological *NARK* activity in nodulation control, as q-RT-PCR in soybean revealed high *NARK* expression in roots, root tips, leaves, petioles, stems and hypocotyls, while shoot and root apical meristems were devoid of *NARK* RNA. High through-put transcript analysis in soybean leaf and root indicated that major genes involved in JA synthesis or response are preferentially down-regulated in leaf but not root of wild type, but not *NARK* mutants, suggesting that AON signaling may in part be controlled by events relating to hormone metabolism. Ethylene and abscisic acid insensitive mutants of *L. japonicus* are described.

Nodulation in legumes has significance to global economies and ecologies, as the nitrogen input into the biosphere allows food, feed and biofuel production without the inherent costs associated with nitrogen fertilization [1]. Nodulation involves the production of a new organ capable of nitrogen fixation [2] and as such is an excellent system to study plant – microbe interaction, plant development, long distance signaling and functional genomics of stem cell proliferation [3, 4].

Concerted international effort over the last 20 years, using a combination of induced mutagenesis followed by gene discovery (forward genetics), and molecular/biochemical approaches revealed a complex developmental pathway that ‘loans’ genetic programs from various sources and orchestrates these into a novel contribution. We report our laboratory’s contribution to the present analysis in the field.

Induced Mutants Facilitate Gene Isolation

In the 1980s we initiated targeted EMS and fast neutron mutagenesis of legumes (soybean; see [5, 6, 7, 8]) that led to the discovery of non-nodulation as well as supernodulation mutants. All alleles behave as loss-

of-function mutations. Extensive characterization of both mutant classes was conducted [9, 10], revealing that NF is perceived by a *LysM* receptor kinase complex encoded by the *GmNFR1* and *GmNFR5* genes of soybean. Both genes, if mutated, lead to nodulation. Orthologous copies are found in other legumes, such as *Lotus japonicus*, *Medicago truncatula* and pea. In soybean, both receptor genes are duplicated (as are most soybean genes), owing to an ancestral genome duplication. Despite the duplicated genome, it was possible to isolate recessive, loss-of-function mutants because detailed genomic analysis revealed that the duplicated copies had functionally diverged. For example, the soybean *GmNFR5* gene exists as an α and β copy, with *GmNFR5 β* being non-functional in many soybean cultivars because of the insertion of a transposable element (A. Indrasumunar, UQ, PhD dissertation; 2008). Other soybean nodulation related genes such as *GmNORK* (needed for both nodulation and mycorrhizal symbioses), *GmKAPP* (encoding kinase associated protein phosphatase; [11]) and *GmPOL* (poltergeist; another protein phosphatase) duplicated in an apparently fully functional fashion, suggesting that mutant phenotypes would be undetectable.

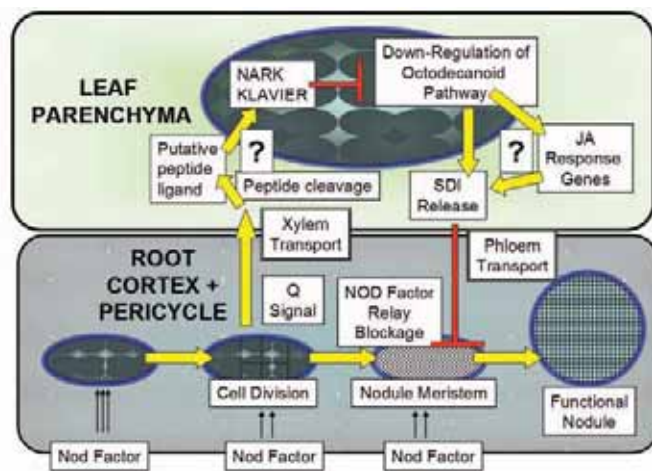

Figure 1 Model of autoregulation of nodulation (AON) as in soybean. Several points of uncertainty exist. SDI (shoot-derived inhibitor) and Q need to be determined; target stages are uncertain though cell division is blocked in soybean. Blockage in alfalfa and pea is earlier with no infection threads. Involvement of different root tissue lineage in this process is still unknown.

Mutants were also isolated for the internal regulation of nodulation, called AON [3, 5, 6, 12]. Again, similar mutants were later found in other legume species, confirming that the underlying genetic and biochemical mechanisms are similar if not identical. Super- or hyper-nodulation mutants exist in *L. japonicus*, *M. truncatula*, pea, and common bean [10, 13]. In most cases, supernodulation is associated with pleiotropic effects, such as nitrate tolerance to nodulation inhibition, altered root growth, and plant growth reductions [14, 15, 16]. Interestingly, *NARK* mutants also lack autoregulation of mycorrhization [17].

ARC Center of Excellence for Integrative Legume Research

¹ IMB; ² AGRF, The University of Queensland, St. Lucia, Brisbane QLD 4072; ³ The University of Melbourne, Melbourne, Vic.; ⁴ RSBS, ANU, Canberra, ACT., Australia, www.cilr.uq.edu.au

* Corresponding author. E-mail: p.gresshoff@uq.edu.au

Using positional cloning approaches based on detailed molecular maps, and BAC clone analysis, high throughput DNA sequencing and candidate gene approaches, the identity of mutated genes was revealed in many cases. Commonly, a LRR receptor kinase related in structure to the *Arabidopsis thaliana* CLAVATA1 gene product is mutated to lead to a supernodulation phenotype [18, 19, 20, 21, 22]. Since reciprocal grafting clearly demonstrated that AON is controlled by the *GmNARK* or *LjHAR1* genotype of the shoot [12, 23], and that suppression of nodule number occurs subject to effective *Rhizobium/Bradyrhizobium* infection of the root, it was proposed that a root-derived nodulation signal (termed Q; [24]) migrates to the leaf where *GmNARK* converts the signal into a nodulation repressor (termed SDI; see Fig. 1.; [25, 26]).

Supernodulation mutants exist that do not fit directly into the NARK paradigm (such as *Psnod3*; *Mtrdn1*; *LjASTRAY* [27] and *LjKLAVER* [28]). The first two, possibly orthologues, are root controlled and may be involved in the sending of the Q signal; the latter two function in the shoot, though their direct function, despite gene characterization (*ASTRAY* encodes a transcription factor, and *KLAVER* a LRR RK) are characterised by changes in vascular development, flowering time, and root gravitropism.

Identification of Direct *GmNARK* Kinase Domain Interacting Protein Phosphatase

The putative catalytic domain of *GmNARK* was expressed and purified as a maltose-binding or a glutathione S-transferase-fusion protein in *Escherichia coli* [11]. The recombinant NARK proteins showed autophosphorylation activity *in vitro*. Several regions of the NARK kinase domain were shown by mass spectrometry to possess phospho-residues. The kinase-inactive protein K724E failed to autophosphorylate, as did three other proteins corresponding to phenotypically detected mutants defective in whole plant autoregulation of nodulation (AON). A wild-type NARK fusion protein transphosphorylates a kinase-inactive mutant NARK fusion protein, suggesting that it is capable of intermolecular autophosphorylation *in vitro*. In addition, Ser-861 and Thr-963 in the NARK kinase catalytic domain were identified as phosphorylation sites through site-directed mutagenesis. The genes coding for the kinase-associated protein phosphatases KAPP1 and KAPP2, two putative interacting components of NARK, were isolated. NARK phosphorylated recombinant KAPP proteins *in vitro*. Autophosphorylated NARK was, in turn, dephosphorylated by both KAPP1 and KAPP2. Our results suggest a model for the signal transduction pathway involving NARK in nodule development control.

Characterization of the *GmNARK* and *LjHAR1* Promoters

Based on qRT-PCR, *GmNARK* is expressed to varying levels throughout the plant; the transcript was detected at high levels in mature leaves and roots but to a lesser extent in young leaves, shoot tips, and nodules [29]. The transcript level was not significantly affected by *Bradyrhizobium japonicum* during the first week following inoculation. In addition, the activities of the promoters of *GmNARK* and *Lotus japonicus* *HAR1*, driving a β -glucuronidase (*GUSPlus*) reporter gene, were examined in stably transformed *L. japonicus* and transgenic hairy roots of soybean. Histochemical GUS activity in *L. japonicus* plants carrying either a 1.7-kb *GmNARKpr::GUS* or 2.0-kb *LjHAR1pr::GUS* construct was clearly localized to living cells within vascular bundles, especially phloem cells in leaves, stems, roots, and nodules. Phloem-specific expression was also detected in soybean hairy roots carrying these constructs [30]. Deletion analysis located a region controlling phloem-specific expression to a DNA sequence between 908 bp and 1.7 kb upstream of the translation start site of *GmNARK*. Regulatory elements required for the transcription of these orthologous genes are conserved. Moreover, rapid amplification of 5' cDNA ends (5' rapid amplification of cDNA ends) revealed two major transcripts of *GmNARK* potentially originating from two

TATA boxes. Further analysis of the *GmNARK* promoter has confirmed that these two TATA boxes are functional.

Search for Signal Molecules in Autoregulation of Nodulation

Bioassays based on nodule numbers and the expression of marker genes have been developed to identify Q in soybean xylem sap and SDI in leaf and phloem extracts. These bioassays will aid in confirming the presence of Q and SDI in samples following purification and fractionation procedures. Such findings will provide a more complete understanding of AON and may lead to the chemical identification of Q and SDI.

To characterize SDI, we developed a short-term nodulation-based bioassay involving feeding aqueous leaf extracts into the petioles of *nts1007* supernodulation mutant plants. Leaf extracts from 18-day-old *Bradyrhizobium japonicum* root-inoculated WT plants suppressed the supernodulation phenotype of *nts1007* plants to near wild-type levels. In contrast, feeding extracts from mutant leaf into wild type plants had no effect on nodule numbers. SDI suppression was *Bradyrhizobium*-inoculation dependent, required *GmNARK* activity, and was heat-, proteinase K- and RNase A-resistant. Extracts were stable and dilutable [31]. Molecular sieving confirmed SDI to be a small compound, with a molecular weight of less than 1,000 daltons. Feeding leaf extracts from *Sinorhizobium*-inoculated *Medicago truncatula* WT plants also suppressed *nts1007* nodule numbers, while extracts from mutant plants altered in *MtSUNN*, orthologous to *GmNARK*, failed to suppress, suggesting the AON molecular mechanism to be widely conserved amongst legumes.

Legumes encode several LRR-RLK linked to the process of root nodule formation, the ligands of which are unknown. To identify ligands for these receptors, Oelkers et al [32] used a combination of profile hidden Markov models and position-specific iterative BLAST, allowing the detection of new members of the CLV3/ESR (CLE) protein family from publicly available sequence databases.

They identified 114 new members of the CLE protein family from various plant species, as well as five protein sequences containing multiple CLE domains, and were able to cluster the CLE domain proteins into 13 distinct groups based on their pairwise similarities in the primary CLE motif. In addition, we identified secondary motifs that coincide with our sequence clusters. The groupings based on the CLE motifs correlate with known biological functions of CLE signaling peptides and are analogous to groupings based on phylogenetic analysis and ectopic overexpression studies. The biological function of two of the predicted CLE signaling peptides was tested in the legume *Medicago truncatula*. These peptides inhibit the activity of the root apical and lateral root meristems in a manner consistent with our functional predictions based on other CLE signaling peptides clustering in the same groups.

Hormonal Sensitivity Mutants in *Lotus japonicus* to Study Nodulation

Using transgenics, a causal relationship between ethylene insensitivity of seedlings and mature legume plants was demonstrated [33], the level of ethylene receptor gene expression, lateral root growth, and *Mesorhizobium loti* inducing nodule initiation. *Lotus japonicus* plants expressing the dominant *ETR1-1* allele from *Arabidopsis thaliana* (*AtETR1-1*) encoding a mutated ethylene receptor were ethylene insensitive as judged by the lack of "Triple Response," and their continued ability to grow and nodulate in the presence of inhibitory concentrations of ACC (1-aminocyclopropane-1-carboxylic acid; an ethylene precursor). Independent transgenic lines varied in their levels of insensitivity that correlated directly to the number of nodulation events after *M. loti* infection and the level of *AtETR1-1* mRNA. Transgenic plants with high insensitivity to ACC had significantly fewer lateral roots and exhibited increased nodulation while showing no altered nitrate sensitivity or lack of systemic autoregulation. While ACC insensitive shoot growth and

nodulation were observed in transformants, primary root growth was still inhibited similarly to wild type. Increased nodulation was caused by increased infection success and a seven-fold increase of the permissive radial zone for initiating nodule foci. The study demonstrates multiple roles for ethylene and cytokinins in nodule initiation by influencing root cell infections and radial positioning [34], independent of autoregulation and nitrate inhibition of nodulation.

An ABA insensitive mutant *Beyma* was isolated in *Lotus japonicus* MG-20 from an EMS mutagenesis population using root growth inhibition to applied ABA as the screening criterion [35]. The stable mutant that segregates as a dominant Mendelian mutation is insensitive to ABA induced inhibition of germination, vegetative growth, stomatal opening as well as nodulation. Tissue ABA levels were normal, suggesting a sensitivity rather than biosynthesis mutation. It is slow-growing (50-70 % of MG-20) and has a near-constitutive wilted phenotype associated with its inability to regulate stomatal opening. Whilst showing a wide range of ABA insensitive phenotypes, *Beyma* did not show alteration of nodule number control, as in the absence of added ABA, the number and patterning (but not size) of nodules formed in the mutant was similar to that of MG-20. Split root experiments on MG-20 showed that application of ABA on one side of the root inhibited nodulation locally but not systemically. We propose that ABA is not involved directly in systemic autoregulation of nodulation (AON).

Transcript Profiling of Soybean Leaves Reveals Novel Candidate Biochemical Networks for AON Function

Kinkema and Gresshoff [36] used transcriptional profiling to identify potential downstream signals of GmNARK. These studies revealed that GmNARK-mediated signaling controls the expression of genes involved in the JA pathway. Genes encoding the key enzymes controlling JA biosynthesis as well as JA-response genes were regulated systemically, but not locally, by root inoculation with *Bradyrhizobium japonicum*. This systemic regulation was abolished in GmNARK mutant plants, indicating that their expression was specifically controlled by signaling events associated with this receptor kinase. These results indicate that the receptor-mediated regulation of JA signaling plays an important role in the AON signal transduction pathway. A second class of genes was identified that were controlled by GmNARK in a rhizobia-independent manner. These candidates provide insight on additional, non-symbiotic signaling pathways that are likely regulated by GmNARK, such as those involved in root growth and defense [37]. The discovery of downstream components of the GmNARK receptor kinase advances our understanding of the systemic control of nodule development and its association with other signaling networks.

ACKNOWLEDGEMENTS

Financial support from the ARC Center of Excellence program, and the University of Queensland is acknowledged, as are former students, staff and colleagues.

BIBLIOGRAPHY

1. Scott, P.T., Pregel, L., Chen, N., Hadler, J.S., Djordjevic, M.A., Gresshoff, P.M. *Pongamia pinnata*: an untapped resource for the biofuels industry of the future. *BioEnergy Research* **1**, 2-11 (2008).
2. Udvardi, M.K., Price, G.D., Gresshoff, P.M., Day, D.A. A dicarboxylate transporter on the peribacteroid membrane of soybean nodules. *FEBS Letters* **231**, 36-40 (1988).
3. Gresshoff, P.M. (1993) Molecular genetic analysis of nodulation genes in soybean. *Plant Breeding Reviews* **11**, 275-318 (1988).
4. Beveridge, C.A., Mathesius, U., Rose, R., Gresshoff, P.M. Common threads of meristem development and homeostasis: branching, nodules and lateral roots. *Curr. Opin. Plant Biology* **10**, 44-51 (2007).

5. Carroll, B.J., McNeil, D.L., Gresshoff, P.M. Isolation and properties of soybean mutants which nodulate in the presence of high nitrate concentrations. *Proc. Natl. Acad. Sci. USA* **82**, 4162-4166 (1985).
6. Carroll, B.J., McNeil, D.L., Gresshoff, P.M. A supernodulation and nitrate tolerant symbiotic (nts) soybean mutant. *Plant Physiol.* **78**, 34-40 (1985).
7. Carroll, B. J., McNeil, D.L., Gresshoff, P.M. Mutagenesis of soybean (*Glycine max* (L.) Merr.) and the isolation of non-nodulating mutants. *Plant Science* **47**, 109-119 (1986).
8. Hoffmann, D., Jiang, J., Men, A., Kinkema, M., Gresshoff, P.M. Nodulation deficiency caused by fast neutron mutagenesis of the model legume *Lotus japonicus*. *J. Plant Physiol.* **164**, 460-469 (2007).
9. Olsson, J.E., Nakao, P., Bohlool, B.B., Gresshoff, P.M. Lack of systemic suppression of nodulation in split root systems of supernodulating soybean (*Glycine max* (L.) Merr.) mutants. *Plant Physiol.* **90**, 1347-1352 (1989).
10. Caetano-Anollés, G., Gresshoff, P.M. Plant genetic control of nodulation. *Ann. Rev. Microbiol.* **45**, 345-382 (1991).
11. Miyahara, A., Hirani, T. A., Oakes, M., Kereszt, A., Kobe, B., Djordjevic, M.A., Gresshoff, P.M. Soybean nodule autoregulation receptor kinase interacts with two kinase-associated protein phosphatases *in vitro*. *J. Biol. Chem.* **283**, 25381-25391 (2008).
12. Delves, A.C., Mathews, A., Day, D.A., Carter, A.S., Carroll, B.J., Gresshoff, P.M. Regulation of the soybean-Rhizobium symbiosis by shoot and root factors. *Plant Physiol.* **82**, 588-590 (1986).
13. Kinkema, M., Scott, P., Gresshoff, P.M. Legume nodulation: successful symbiosis through short and long-distance signaling. *Funct. Plant Biol.* **33**, 770-785 (2006).
14. Day, D.A., Lambers, H., Bateman, J., Carroll, B.J., Gresshoff, P.M. Growth comparisons of a supernodulating soybean (*Glycine max*) mutant and its wild-type parent. *Physiol. Plant.* **68**, 375-382 (1986).
15. Buzas, D.M., Gresshoff, P.M. Short and long distance control of root development by LjHAR1 during the juvenile stage of *Lotus japonicus*. *J. Plant Physiology* **164**, 452-459 (2007).
16. Wopereis J., Pajuelo E., Dazzo F.B., Jiang Q., Gresshoff P.M., De Bruijn F.J., Stougaard J., Szczyglowski K. Short root mutant of *Lotus japonicus* with a dramatically altered symbiotic phenotype. *Plant Journal* **23**, 97-114 (2000).
17. Meixner, C., Ludwig-Müller, J. Miersch, O., Gresshoff, P.M., Staehelin, C., Vierheilig, H. Lack of mycorrhizal autoregulation and phytohormonal changes in the supernodulating soybean mutant nts1007. *Planta* **222**, 709-715 (2005).
18. Searle, I.R., Men, A.M., Laniya, T.S., Buzas, D.M., Iturbe-Ormaetxe, I., Carroll, B.J., Gresshoff, P.M. Long distance signaling for nodulation control in legumes requires a CLAVATA1-like receptor kinase. *Science* **299**, 109-112 (2003).
19. Nishimura, R., Hayashi, M., Wu, G.J., Kouchi, H., Imaizumi-Anraku, H., Murakami, Y., Kawasaki, S., Akao, S., Ohmori, M., Nagasawa, M., Harada, K., Kawaguchi, M. HAR1 mediates systemic regulation of symbiotic organ development. *Nature* **420**, 426-429 (2002).
20. Schnabel, E., Journet, E.P., de Carvalho-Niebel, F., Duc, G., Frugoli, J. The *Medicago truncatula* SUNN gene encodes a CLV1-like leucine rich repeat receptor kinase that regulates nodule number and root length. *Plant Mol. Biol.* **58**, 809-822 (2005).
21. Krusell, L., Madsen, L.H., Sato, S., Aubert, G., Genua, A., Szczyglowski, K., Duc, G., Kaneko, T., Tabata, S., de Bruijn, F., Pajuelo, E., Sandal, N., Stougaard, J. Shoot control of root development is mediated by a receptor-like kinase. *Nature* **420**, 422-426 (2002).
22. Men, A.E., Laniya, T.S., Searle, I.R., Iturbe-Ormaetxe, Hussain, A.K.M., Gresshoff, I., Jiang, Q., Carroll, B.J., Gresshoff, P.M. Fast neutron mutagenesis of soybean (*Glycine soja* L.) produces a supernodulating mutant containing a large deletion. *Genome Letters* **3**, 147-155 (2002).
23. Jiang, Q., Gresshoff, P.M. Shoot-control and genetic mapping of the har1-1 (hypernodulation and aberrant root formation) mutant of *Lotus japonicus*. *Functional Plant Biol.* **29**, 1371-1376 (2002).
24. Djordjevic, M.A., Oakes, M., Li, D.-X., Hwang, C.-H., Hocart, C.H., Gresshoff P.M. The *Glycine max* xylem sap and apoplast proteome. *J. Proteome Research* **6**, 3771-3779 (2007).
25. Gresshoff, P.M. Post-genomic insights into nodulation. *Genome Biology* **4**, 201 (2003).
26. Gresshoff P.M., Delves A. Plant genetic approaches to symbiotic nodulation and nitrogen fixation in legumes, *Plant Gene Res* **3**, p.159-206 (1986).
27. Nishimura, R., Ohmori, M., Fujita, H., Kawaguchi, M. A *Lotus* basic leucine zipper protein with a RING-finger motif negatively regulates the developmental program of nodulation. *Proc. Nat. Acad. Sci. USA* **99**, 15206-15 210 (2002).

28. Oka-Kira, E., Tateno, K., Miura, K., Haga, T., Hayashi, M., Harada, K., Sato, S., Tabata, S., Shikazono, N., Tanaka, A., Watanabe, Y., Fukuhara, I., Nagata, T., Kawaguchi, M. *klav*, a novel hypernodulation mutant of *Lotus japonicus* affected in vascular tissue organization and floral induction. *Plant J.* **44**, 505-515 (2005).
29. Nontachaiyapoom, S., Kinkema, M., Scott, P.T., Schenk, P.M., Men, A.E., Gresshoff, P.M. Promoters of orthologous soybean and *Lotus japonicus* nodulation autoregulation genes interchangeably drive phloem-specific expression in transgenic plants. *Mol. Plant Microbe Interact.* **20**, 769-790 (2007).
30. Kereszt, A., Dong-Xue, Li, Indrasumunar, A., Nyugen, C., Nontachaiyapoom, S., Gresshoff, P.M. Testing gene function in transgenic soybean roots. *Nature Protocols* **2**, 948-952 (2007).
31. Lin, Y.-H., Ferguson, B.J., Kereszt, A., Gresshoff, P.M. Specific suppression of supernodulation in soybean by a leaf-extracted, NARK- and inoculation-dependent small molecular fraction. (submitted)
32. Oelkers, K., Goffard, N., Weiller, G.F., Gresshoff, P.M., Mathesius, U., Frickey, T. Bioinformatic analysis of the CLE signaling peptide family. *BMC Plant Biology* **8**, 1 (2008).
33. Lohar, D., Stiller, J., Kam, J., Stacey, G., Gresshoff, P.M. Ethylene insensitivity conferred by the *Arabidopsis Etr1-1* receptor gene alters the nodulation response of transgenic *Lotus japonicus*. *Annals of Botany*. doi: 10. 1093/aob/mcpl32 (2009).
34. Gonzalez-Rizzo, S., Crespi, M., Frugier, F. The *Medicago truncatula* CRE1 cytokinin receptor regulates lateral root development and early symbiotic interaction with *Sinorhizobium meliloti*. *Plant Cell* **18**, 2680-2693 (2006).
35. Biswas, B., Chan, P.K., Gresshoff, P.M. A novel ABA insensitive mutant of *Lotus japonicus* with a wilted phenotype but unaltered nodulation regulation. *Molecular Plant* **2**, 487-499 (2009).
36. Kinkema, M., Gresshoff, P.M. Identification of downstream signals for the soybean autoregulation of nodulation receptor kinase GmNARK. *Mol. Plant Microbe Interactions* **21**, 1337-1348 (2008).
37. Caba, J.M., Luz-Centeno, M., Fernández, B., Gresshoff, P.M., Ligeró, F. Inoculation and nitrate alter phytohormone levels in soybean roots: differences between a supernodulating mutant and the wild type. *Planta* **211**, 98-104 (2000).

Metabolite Profiling of Induced Mutants of Rice and Soybean

T Frank¹, F Yuan², Q Y Shu^{2,3} & K-H Engel^{1,*}

Abstract

The low phytic acid (*lpa*) rice (*Os-lpa*-XS110-1, *Os-lpa*-XS110-2) and soybean (*Gm-lpa*-TW-75-1, *Gm-lpa*-ZC-2) mutants generated by γ -irradiation were studied, aimed at comparing these mutants to the corresponding wild-types by means of metabolite profiling based on capillary gas chromatography/mass spectrometry. The usefulness of this approach to assist in the elucidation of the types of mutation resulting in reduced contents of phytic acid should be explored. Metabolite profiling aspires to provide a comprehensive picture of the metabolites present in biological systems. It aims at extracting, detecting, identifying, and quantifying a broad spectrum of compounds in a single sample, to provide a deeper insight into complex biological systems. The extraction and fractionation method used allowed a comprehensive coverage of a broad spectrum of low molecular weight metabolites ranging from lipophilic (fatty acids methyl esters, hydrocarbons, free fatty acids, sterols, tocopherols) to hydrophilic (sugars, sugar alcohols, organic acids, amino acids) compounds. For rice, considerable amounts of the peaks detected were statistically significantly different between wild-types and *lpa* mutants grown in the same field trial. However, only a few of these differences could be consistently observed in all analyzed field trials, indicating a strong influence of the biological variability. Metabolites consistently shown to be significantly different between wild-type and *lpa* rice mutants, were found to be closely related to the biogenetic pathways leading to phytic acid. This allowed a prediction of the mutation targets for the *lpa* rice mutants in the biosynthetic pathway of phytic acid. Similar effects, i.e. statistically significantly different levels of metabolites closely related to the biosynthesis of phytic acid, were consistently observed for soybean.

Introduction

Myo-inositol 1,2,3,4,5,6-hexakisphosphate (phytic acid or Ins(1,2,3,4,5,6)P₆) is the major storage form of phosphorus in plants [1]. Approximately, 65% to 85 % of total phosphorus in mature plant seeds is found in this compound [2,3].

The first step in the biosynthesis of phytic acid represents the conversion of D-glucose 6-phosphate to 1D-*myo*-inositol 3-phosphate (Ins(3)P₁) catalyzed by 1D-*myo*-inositol 3-phosphate synthase (MIPS) [4,5]. The subsequent steps leading to phytic acid are not fully clarified. Stepwise phosphorylation of Ins(3)P₁ to phytic acid seems plausible, especially as a phosphoinositol kinase which phosphorylates InsP₁, InsP₂, InsP₃, InsP₄ and InsP₅ to the next higher homolog has been identified in mung bean [6]. In addition to Ins(3)P₁, free *myo*-inositol formed through dephosphorylation of Ins(3)P₁ has been discussed as an intermediate in the biosynthesis of phytic acid. A *myo*-inositol kinase (MIK) has been

isolated from maize which phosphorylates *myo*-inositol but not Ins(3)P₁. Mutation of the gene encoding MIK resulted in a significant decrease in phytic acid content [7].

Phytic acid represents an anti-nutrient in food and feed. It limits the bioavailability of minerals such as iron, zinc, calcium and selenium by formation of indigestible chelates [8,9]. In addition, phytic acid is poorly degraded in the digestive system of humans and non-ruminants [10]. Thus, the phytic acid phosphorus is not bioavailable. Animal feed producers and farmers must therefore add phosphate to feed to ensure its nutritional quality. Moreover, excreted phytic acid in manure is degraded by natural soil microorganisms releasing phosphate, which contributes to eutrophication of water [11].

Various efforts have been made to breed crop varieties low in phytic acid content. Transformation of the MIPS gene in antisense orientation into rice plants resulted in a significant increase in inorganic phosphate, which indicates a molar-equivalent decrease in phytic acid [12]. In addition to this targeted molecular approach, mutation breeding has been successfully applied to generate low phytic acid (*lpa*) crops. *Lpa* mutants have been generated for maize [13-15], barley [16], rice [17,18], soybean [19,20] and wheat [21]. In order to identify mutation targets responsible for decreased phytic acid levels genetic approaches and targeted analysis of metabolites involved in the biosynthesis of phytic acid have been applied. In a soybean *lpa* mutant a single base change in the MIPS gene leading to decreased enzyme activity was detected by gene sequencing [20]. Targeted analysis of inositol phosphates in barley *lpa* mutants revealed that reduction in phytic acid was accompanied by an increase in InsP₃, InsP₄ and InsP₅, which suggested a lesion in the phosphorylation steps rather than in the MIPS gene [16].

In addition to genetic approaches and targeted analysis of individual compounds, metabolite-profiling techniques have been proposed as useful tools for plant functional genomics [22]. Metabolite profiling aspires to provide a comprehensive picture on the metabolites present in biological systems. It aims at extracting, detecting, identifying, and quantifying a broad spectrum of compounds in a single sample to provide a deeper insight into complex biological systems. Moreover, metabolite-profiling techniques have been proposed as valuable tools for the detection of unintended effects caused by genetic engineering of food crops [23]. In case of new plant varieties developed with traditional techniques, application of metabolite profiling for the assessment of the safety of these crops has also been suggested [24,25].

The objective of this study was to compare *lpa* mutants of rice (*Os-lpa*-XS110-1, *Os-lpa*-XS110-2) and soybean (*Gm-lpa*-TW751, *Gm-lpa*-ZC-2) with their corresponding rice (Xiushui 110) and soybean wild-types (Taiwan 75, Zhechun No. 3) on the basis of metabolite profiling. Recently, first attempts to apply metabolomic analysis to low phytic acid mutants of maize [26] and rice [27] have been reported.

Description of the metabolite profiling procedure

Metabolite profiling was performed according to the extraction and fractionation scheme shown in Figure 1 [28]. The experimental procedure has

¹ Lehrstuhl für Allgemeine Lebensmitteltechnologie, Technische Universität München, Am Forum 2 D-85350 Freising-Weihenstephan, Germany.

² IAEA-Zhejiang University Collaborating Center, Institute of Nuclear Agricultural Sciences, Zhejiang University, Hangzhou 310029, China.

³ Joint FAO/IAEA Division of Nuclear Techniques in Food and Agriculture, International Atomic Energy Agency, Wagramer Straße 5, P.O. Box 100, 1400 Vienna, Austria.

* Corresponding author. E-mail: k.h.engel@wzw.tum.de

been described in detail [27]. Briefly, lipids and polar compounds were consecutively extracted from the freeze-dried rice and soybean flour. Lipids were transesterified in methanol and subsequently separated by solid phase extraction into a fraction containing fatty acid methyl esters (FAME) and hydrocarbons (fraction I, Fig. 2A) and a fraction containing minor lipids, e.g. free fatty acids, fatty alcohols and sterols (fraction II, Fig. 2B). Selective hydrolysis of silylated derivatives was applied to separate the polar extract into a fraction containing silylated sugars and sugar alcohols (fraction III, Fig. 2C) and a fraction containing inorganic and organic acids, amino acids and amines (fraction IV, Fig. 2D). The four fractions obtained were analyzed by capillary gas chromatography (GC-FID and GC-MS).

Peak heights and corresponding retention times were exported to Chrompare, a software tool developed for comparative analysis of metabolite profiling data [29] (www.chrompare.com). Chrompare automatically corrects retention time shifts on the basis of retention time standards and standardizes peak heights on the basis of internal standards added before the fractionation process. Comparison of metabolite profiles is performed by comparison of mean standardized peak heights based on triplicate analysis. Means are considered as statistically significant different if their confidence intervals ($p < 0.05$) are not overlapping. The magnitude of difference is calculated and peaks observed in only one sample are reported as additional/missing peaks.

Metabolite profiling of low phytic acid (*lpa*) mutants

Low phytic acid (*lpa*) rice mutants

For investigation of the overall variance between *lpa* rice mutants *Os-lpa*-XS110-1 and *Os-lpa*-XS110-2, GC-FID metabolite profiling data were analyzed by means of principal component analysis (PCA). PCA plots containing GC-FID data from fractions III and IV are shown in Figure 3.

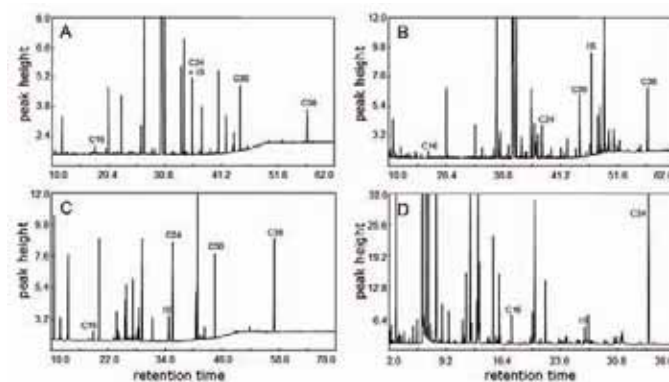

Figure 2 GC-FID chromatograms of fraction I (A), II (B), III (C) and IV (D) obtained from rice. IS: internal standards tetradecane (A), 5 α -cholestane-3 β -ol (B), phenyl- β -D-glucopyranoside (C), p-chloro-L-phenylalanine (D). C16, C24, C30, C38: retention time standards hexadecane, tetracosane, triacontane and octatriacontane.

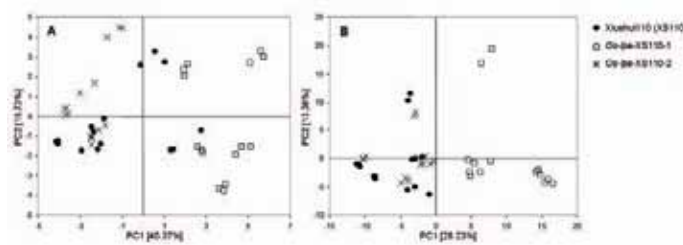

Figure 3 Principal component analysis (PCA) of standardized GC-FID metabolite profiling data from fraction III (A) and IV (B) of rice wild-type Xiushui110 and the two low phytic acid mutants *Os-lpa*-XS110-1 and *Os-lpa*-XS110-2.

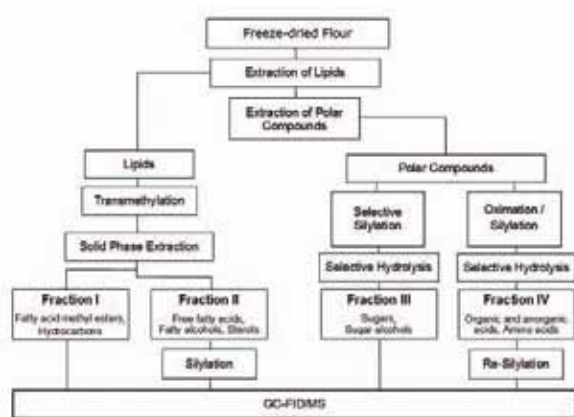

Figure 1 Extraction and fractionation of freeze-dried rice and soybean flour, according to [28].

A clear separation of *Os-lpa*-XS110-1 from Xiushui110 was observed, whereas no differentiation between *Os-lpa*-XS110-2 and the wild-type could be achieved. This indicated different types of mutations for the two *lpa* rice mutants.

Results obtained by comparative metabolite profiling of the wild-type Xiushui110 and the two *lpa* rice mutants are shown in Table 1. For each field trial the sum of peaks included for comparison was more than 100. On average, 34% (*Os-lpa*-XS110-1) and 42% (*Os-lpa*-XS110-2) of the peaks included were statistically significantly different between the wild-type and the mutants [27].

Table 1. Peak-based comparison of chromatograms obtained by metabolite profiling of fractions I-IV of wild-type rice Xiushui110 (XS110) and low phytic acid mutant lines *Os-lpa*-XS110-1 and *Os-lpa*-XS110-2

	Field trial								consistent differences ^c
	Hainan		Jiaxing		Hangzhou 1		Hangzhou 2		
wild-type vs. <i>lpa</i> mutant	total ^a	diff. ^b	total	diff.	total	diff.	total	diff.	
XS110 vs. <i>Os-lpa</i> -XS110-1	123	38	119	38	115	45	108	38	4
XS110 vs. <i>Os-lpa</i> -XS110-2	118	27	116	63	113	35	108	67	2

^a Number of peaks included for comparison
^b Number of peaks statistically significant different between wild-type and mutant ($p < 0.05$)
^c Number of peaks statistically significant different between wild-type and mutant at all four field trials

Although the number of peaks statistically significantly different at one field trial was relatively high, only a few of these differences could be consistently observed at all four field trials. Identification of these consistent differences revealed increased contents of phosphate in both mutant lines. Levels of galactose, raffinose and *myo*-inositol were consistently increased in *Os-lpa*-XS110, whereas the level of *myo*-inositol was decreased in *Os-lpa*-XS110-2. Further, the level of 24-methylene-cycloartanol (24-MCA) was consistently increased in this mutant. Changes in mean standardized peak heights of phosphate, *myo*-inositol and raffinose for both *lpa* mutants compared to wild-type Xiushui110 are shown in Figure 4.

Except for 24-MCA, metabolites shown to be consistently statistically significantly different between wild-type and *lpa* rice mutants, were found to be closely related to the biogenetic pathways leading to phytic acid (Figure 5). Consideration of these metabolic changes in the light of the routes involved in the biosynthesis of phytic acid indicated a disturbance in the early biosynthetic pathway of phytic acid in *Os-lpa*-XS110-2 and a mutation event affecting phosphorylation of *myo*-inositol in *Os-lpa*-XS110-1 [27]. The metabolite profiling-based prediction for *Os-lpa*-XS110-1 was in accordance with molecular mapping results, which placed the *lpa* mutation on a site very close to the locus that encodes the putative *myo*-inositol kinase (MIK) gene in rice [18].

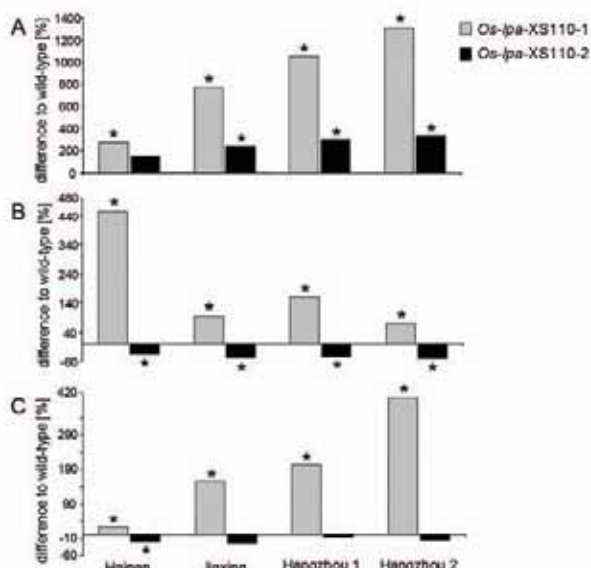

Figure 4 Differences in mean standardized peak heights (triplicate analysis) of phosphate (A), *myo*-inositol (B) and raffinose (C) between wild-type Xiushui110 and the two mutant lines *Os-lpa*-XS110-1 and *Os-lpa*-XS110-2 grown in four field trials. An asterisk indicates a statistically significant difference from the wild-type ($p < 0.05$).

Low phytic acid (*lpa*) soybean mutants.

Results obtained by comparative metabolite profiling of the wild-type soybeans Taiwan75 and Zhechun No. 3 and the two corresponding *lpa* mutants *Gm-lpa*-TW75-1 and *Gm-lpa*-ZC-2 are shown in Table 2.

Table 2. Peak-based comparison of chromatograms obtained by metabolite profiling of fractions I-IV of wild-type soybeans (Taiwan 75, Zhechun No.3) and low phytic acid mutant lines *Gm-lpa*-TW75-1 and *Gm-lpa*-ZC-2

	Field trial				total	diff.	total	diff.	total	diff.	consistent differences ^c
	Hainan 4/05	Hainan 05/06	Hangzhou s05	Hangzhou a05							
wild-type vs. <i>lpa</i> mutant	total ^a	diff. ^b	total	diff.	total	diff.	total	diff.	total	diff.	
TW75 vs. <i>Gm-lpa</i> -TW75-1	- ^d	168	69	181	65	165	70	23			
Zh. No.3 vs. <i>Gm-lpa</i> -ZC-2	166	27	164	55	157	13	167	43	3		

^a Number of peaks included for comparison

^b Number of peaks statistically significant different between wild-type and mutant ($p < 0.05$)

^c Number of peaks statistically significant different between wild-type and mutant at all four field trials

^d Samples not available

For each field trial the sum of peaks included for comparison was more than 150. On average, 40% (*Gm-lpa*-TW75-1) and 21% (*Gm-lpa*-ZC-2) of the peaks included were statistically significantly different between the wild-types and the mutants.

Again, a majority of the metabolites shown to be consistently statistically significantly different between wild-types and *lpa* soybean mutants, were found to be closely related to the biogenetic pathways leading to phytic acid (Figure 5). For example, levels of *myo*-inositol were decreased in *Gm-lpa*-TW75-1 compared to Taiwan 75, but increased in *Gm-lpa*-ZC-2 compared to Zhechun No. 3. Changes observed on the basis of metabolite profiling indicate a mutation in the 1D-*myo*-inositol 3-phosphate synthase (MIPS) (Figure 5). This mutation target was also postulated on the basis of data from molecular mapping [30].

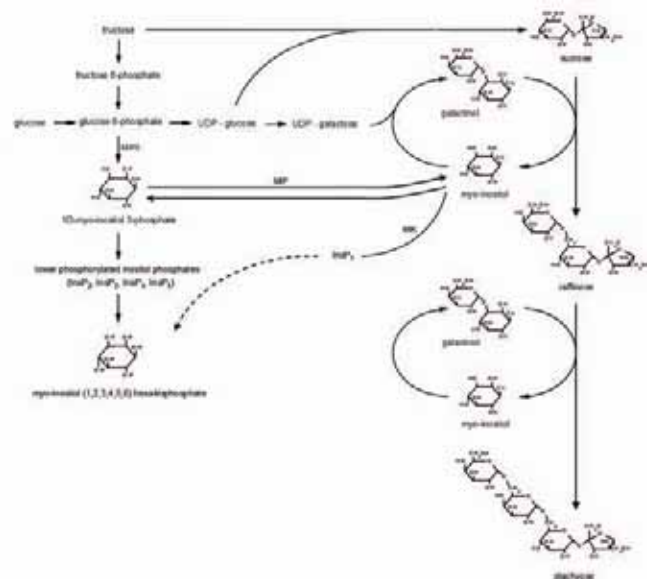

Figure 5 Plant biosynthetic pathways leading to phytic acid, raffinose and stachyose. The dotted line indicates a not fully clarified pathway. MIPS: 1D-*myo*-inositol 2 phosphate, MIP: *myo*-inositol monophosphate, MIK: *myo*-inositol kinase.

BIBLIOGRAPHY

- Cosgrove, D.J. Inositol Hexakisphosphates. In Inositol Phosphates: Their Chemistry, Biochemistry, and Physiology; Cosgrove, D. J., Ed.; Elsevier Scientific Publishing Company: Amsterdam, 26-43 (1980).
- Raboy, V. Biochemistry and genetics of phytic acid synthesis. *Plant Biology* **9**, 55-76 (1990).
- Raboy, V. Accumulation and storage of phosphate and minerals [during seed development]. Cellular and Molecular Biology of Plant Seed Development; Larkins, B. A., Vasil, I.K., Eds., Kluwer Academic Publishers, Dordrecht, The Netherlands, 441-477 (1997).
- Loewus, F.A., Loewus, M.W. *myo*-Inositol: its biosynthesis and metabolism. *Annu. Rev. Plant Physiol.* **34**, 137-161 (1983).
- Majumder, A.L. *et al.* 1L-*myo*-Inositol-1-phosphate synthase. *Biochim. Biophys. Acta* **1348**, 245-256 (1997).
- Majumder, A.N.L. *et al.* Phosphoinositol kinase from germinating mung bean seeds. *Phytochemistry* **11**, 503-508 (1972).
- Shi, J. *et al.* The maize low-phytic acid 3 encodes a *myo*-inositol kinase that plays a role in phytic acid biosynthesis in developing seeds. *Plant J.* **42**, 708-719 (2005).
- Gilloly, M. *et al.* The effects of organic acids, phytates and polyphenols on the absorption of iron from vegetables. *Br. J. Nutr.* **49**, 331-342 (1983).
- Saha, P.R. *et al.* Mineral Bioavailability in Rats from Intrinsically Labeled Whole Wheat Flour of Various Phytate Levels. *J. Agric. Food Chem.* **42**, 2531-2535 (1994).
- Sandberg, A.S. *et al.* Degradation products of bran phytate formed during digestion in the human small intestine: effect of extrusion cooking on digestibility. *J. Nutr.* **117** 2061-2065 (1987).
- Sharpley, A.N. *et al.* Managing agricultural phosphorus for protection of surface waters: issues and options. *J. Environ. Qual.* **23**, 437-451 (1994).
- Feng, X., Yoshida, K.T., Molecular approaches for producing low - phytic - acid grains in rice. *Plant Biotechnol.* **21**, 183-189 (2004).

13. Raboy, V. *et al.* Origin and seed phenotype of maize low phytic acid 1-1 and low phytic acid 2-1. *Plant Physiol.* **124**, 355-368 (2000).
14. Shi, J. *et al.* The maize low-phytic acid mutant lpa2 is caused by mutation in an inositol phosphate kinase gene. *Plant Physiol.* **131**, 507-515 (2003).
15. Pilu, R. *et al.* Phenotypic, genetic and molecular characterization of a maize low phytic acid mutant (lpa241). *Theor. Appl. Genet.* **107**, 980-987 (2003).
16. Dorsch, J.A. *et al.* Seed phosphorus and inositol phosphate phenotype of barley low phytic acid genotypes. *Phytochemistry* **62**, 691-706 (2003).
17. Larson, S.R. *et al.* Isolation and genetic mapping of a non-lethal rice (*Oryza sativa* L.) low phytic acid 1 mutation. *Crop Sci.* **40**, 1397-1405 (2000).
18. Liu, Q.L. *et al.* Generation and characterization of low phytic acid germplasm in rice (*Oryza sativa* L.). *Theor. Appl. Genet.* **114**, 803-814 (2007).
19. Wilcox, J.R. Isolation of High Seed Inorganic P, Low-Phytate Soybean Mutants. *Crop Sci.* **40**, 1601-1605 (2000).
20. Hitz, W.D. *et al.* Biochemical and molecular characterization of a mutation that confers a decreased raffinose and phytic acid phenotype on soybean seeds. *Plant Physiol.* **128**, 650-660 (2002).
21. Guttieri, M. *et al.* Identification and characterization of a low phytic acid wheat. *Crop Sci.* **44**, 418-424 (2004).
22. Fiehn, O. *et al.* Metabolite profiling for plant functional genomics. *Nature Biotechnol.* **18**, 1157-1161 (2000).
23. Cellini, F. *et al.* Unintended effects and their detection in genetically modified crops. *Food Chem. Toxicol.* **42**, 1089-1125 (2004).
24. Kuiper, H.A. *et al.* Assessment of the food safety issues related to genetically modified foods. *Plant J.* **27**, 503-528 (2001).
25. Kuiper, H.A. *et al.* Exploitation of molecular profiling techniques for GM food safety assessment. *Curr. Opin. Biotechnol.* **14**, 238-243 (2003).
26. Hazebroek, J. *et al.* Metabolomic analysis of low phytic acid maize kernels. In *Concepts in Plant Metabolomics*, Nikolau, B. J., Wurtele, E.S., Eds., Springer, Berlin, 221-237 (2007).
27. Frank, T. *et al.* Metabolite profiling of low phytic acid (*lpa*) rice mutants. *J. Agric. Food Chem.* **55**, 11011-11019 (2007).
28. Frenzel, T. *et al.* Metabolite profiling – a fractionation method for analysis of major and minor compounds in rice grains. *Cereal Chem.* **79**, 215-221 (2002).
29. Frenzel, T. *et al.* A methodology for automated comparative analysis of metabolite profiling data. *Eur. Food Res. Technol.* **216**, 335-342 (2003).
30. Yuan, F.J. *et al.* Generation and characterization of two novel low phytate mutations in soybean (*Glycine max* L. Merr.). *Theor. Appl. Genet.* **115**(7), 945-957 (2007).

Genomics Meets Induced Mutations in Citrus: Identification of Deleted Genes Through Comparative Genomic Hybridization

G Rios, M A Naranjo, D Iglesias, O Ruiz & M Talon*

Abstract

We report on the use of genomic approaches to identify pivotal genes in induced citrus mutants. Citrus is the most economically important fruit crop in the world and Spain is the first fresh citrus producer. The survival of the citrus industry is critically dependent on genetically superior cultivars but improvements in fruit quality traits through traditional techniques are extremely difficult due to the unusual combination of biological characteristics of citrus. Genomic science, however, holds promise of improvements in breeding. In this work, we reported the successful identification of genes included in hemizygous deletions induced by fast neutron irradiation on *Citrus clementina*. Microarray-based CGH was used to identify underrepresented genes in a citrus mutant that shows color break delay. Subsequent confirmation of gene doses through quantitative PCR and comparison of best hits of putative deleted citrus genes against annotated genomes from other eudicots, specially poplar, enabled the prediction that these genes were clustered into a 700 kb fragment. The availability of *Citrus* BAC end sequences helped to draw a partial physical map of the deletion. Furthermore, gene content and order in the deleted segment was established by PCR location of gene hits on the physical map. Finally, a lower chlorophyll a/b ratio was found in green tissues from the mutant, an observation that can be related to the hemizygous deletion of a ClpC-like gene, coding a putative subunit of a multifunctional protease complex located into the chloroplast. Analysis of gene content and order inside this *Citrus* deletion led to the conclusion that microsynteny and local gene colinearity with *Populus trichocarpa* were higher than with the phylogenetically closer *Arabidopsis thaliana* genome. In conclusion, a combined strategy including genomics tools and induced citrus mutations has been proved to be a successful approach to identify genes with major roles in citrus fruit development.

Introduction

Citrus, one the most important fruit crops worldwide, are woody, perennial trees requiring a juvenility period of several years and are frequently parthenocarpic and sexually self-incompatible [1]. These conditions considerably impair traditional breeding, while current alternative methods for variety improvement such as marker-assisted selection, somatic hybridization or mutation breeding also are of limited use mostly because the *Citrus* genome is scarcely characterized.

In recent years, *Citrus* has been the target of several genomic developments including large EST collections [3,4], cDNA and oligonucleotide-based microarrays [5-8], BAC libraries and BAC end sequencing (BES). Genomic technology, including methods to rapidly identify and manipulate genes of agricultural interest, holds promise of improvements in several areas that may be difficult through traditional approaches. However, functional studies, i.e. genetic transformation and the capability to perform reverse genetic analyses, are also considerably impaired. In citrus,

high throughput transgenic programs such as the generation of RNA interference knockouts, activation tagging through enhancer elements, gene-trap T-DNA insertions, or transposon tagging systems have not yet been developed. Since no efficient tagging or insertional procedures are available in these species, other gene disruption methods including strategies based on genome-wide mutagenesis such as TILLING and fast neutron mutagenesis have been initiated. These approaches are non-transgenic and may have particular interest for the industry where the debate on genetically modified organisms has restricted crop improvement. Both approaches, however, are of limited usefulness as strategies for reverse genetics because of the lack of knowledge on *Citrus* genomic sequence and the large amount of space required for mutant populations of a suitable size. ECOTILLING, however, on natural citrus variants and microarray-based detection of deletions on fast neutron citrus mutants in a more direct genetic strategy are apparently very straightforward approaches.

The main objective of this work was to identify deleted genes on a heterozygous genetic *Citrus* background, provided by fast neutron generated mutants, through array-Comparative Genomic Hybridization. In addition, we also explored the possibility of using comparative genomics with annotated dicot genomes assisted by BAC end sequencing for the generation of realistic partial physical maps of the deleted *Citrus* regions.

Materials and Methods

Plant material

Plant material from approximately six-year-old standard and 39B3 and 39E7 mutant lines of the clementine (*Citrus clementina* Hort. Ex Tan. cv. Clemenules) variety was used in this study. The 39B3 and 39E7 genotypes that showed altered patterns of color change of fruit peel were obtained through bud irradiation with fast neutrons and are expected to carry DNA deletion lesions in hemizygous dosage.

Array-CGH

The protocol was adapted from several published array-Comparative Genomic Hybridization (array-CGH) methods pursuing mainly the measurement of copy-number changes in human genomic DNA [9-11], and the study of large-scale genetic variation of the symbiotic bacteria *Sinorhizobium meliloti* [12].

Gene dosage measurements

Quantitative real-time PCR was performed on a LightCycler 2.0 instrument using the LightCycler FastStart DNA MasterPLUS SYBR Green I kit following manufacturer's instructions.

Similarity searches

DNA sequences of *Citrus* unigenes containing positive array-CGH ESTs were used in online TBLASTX searches against genomic databases from the annotated genomes of *Arabidopsis thaliana* [13], *Populus trichocarpa* [14] and *Vitis vinifera* [15]. For each gene, the best hit was placed on a chromosomal map while the second and third hits were only positioned

Centro de Genómica, Instituto Valenciano de Investigaciones Agrarias (IVIA), Moncada, Valencia, Spain

* Corresponding author. E-mail: talon_man@gva.es

in the map if they were located closer than 250 kb to any other hit. Two 700 kb regions from chromosomes 12 and 15 from the *Populus* genome including homologous genes to 39B3 array-CGH positive unigenes, were used as queries in a BLASTN local search on a *Citrus* BAC end sequence database.

BAC isolation and analysis

DNA from *Citrus* BACs was isolated with the Rapid Plasmid Miniprep System (Marligen Biosciences, cat. n° 11453-016). Purified BACs were used as templates in PCR reactions in a total volume of 15 µl, including 0.2 mM dNTP, 2 mM MgCl₂, 0.5 µM of each primer, 0.38 units of Netzyme DNA polymerase (Molecular Netline Bioproducts) and 0.1 ng of BAC DNA. After an initial denaturing step for 5 min at 95°C, amplification was performed for 35 cycles of 30 sec at 95°C, 30 sec at 60°C and 30 sec at 72°C, followed by 5 min incubation at 72°C. The PCR product was subjected to 1.5% agarose DNA electrophoresis.

Results and Discussion

Procedure for the characterization of hemizygous deletions

The proposed procedure to identify deleted genes is illustrated in **Figure 1**. This method uses microarrays to hybridize genomic DNA extracted from the deletion mutants to render a list of underrepresented genes. The putative deleted genes are then validated through gene dosage evaluation by real-time PCR with specific primers. Deleted genes may in this way contribute to the identification of the molecular mechanisms underlying the observed phenotypes by means of a candidate gene approach, validated by physiological analyses or genetic transformation. In non-sequenced genomes or in plants with poor development of physical maps, further characterization of deletions at the structural level requires TBLASTX similarity searches against databases containing the sequence annotation of known eudicot genomes. Local physical maps of deletions are built allocating the deleted gene sequences and the syntenic genomic fragments from these eudicots into a BES database of the species of interest. Lastly, specific PCR on the array of BACs contributes to confirm gene content and order on the lineal structure of the deletions.

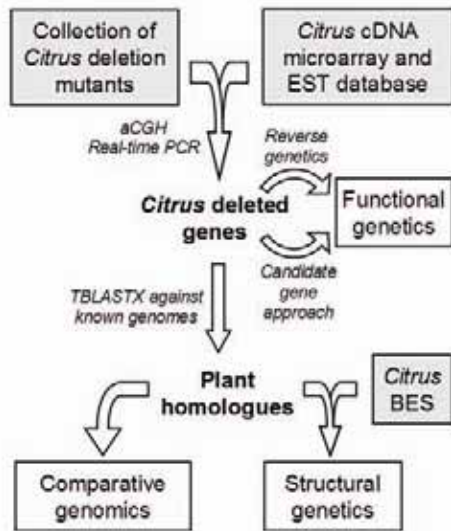

Figure 1 Schematic guidelines for the characterization of hemizygous deletion Citrus mutants. Arrows indicate successive steps of mutant characterization. Plant material and genomic resources are highlighted on grey boxes while gained knowledge on genetics and genomics are highlighted on white rectangles. Genes are shown in bold and methods and approaches in italics.

Identification of deleted alleles in 39B3 and 39E7 fast neutron mutants of Citrus clementina

Putative deleted genes in the mutants were first identified through an approach based on genomic hybridization (array-CGH) that exploited a recently developed *Citrus* microarray containing 21240 cDNAs [13,14]. The number of ESTs selected as putative candidates was 24 and 78 for mutants 39B3 and 39E7, respectively. Gene dosage of 39B3 candidates ranged from 0.50 to 0.60 when genomic DNA from the 39B3 and 39E7 genotypes was tested.

Clustering of homologues of Citrus deleted genes in the poplar genome

The homologous regions produced by the best TBLASTX hit of each of the *Citrus* candidate genes were located on the chromosome maps of *Arabidopsis*, poplar and grapevine [15]. **Figure 2** represents in detail chromosome mappings of the 39B3 mutation, which was subjected to further analyses. In *Populus*, most of the candidate genes mapped to two different genome regions of approximately 700 kb long in chromosomes 12 and 15, two duplicated chromosomes probably originated during the recent genome duplication event occurred in this species.

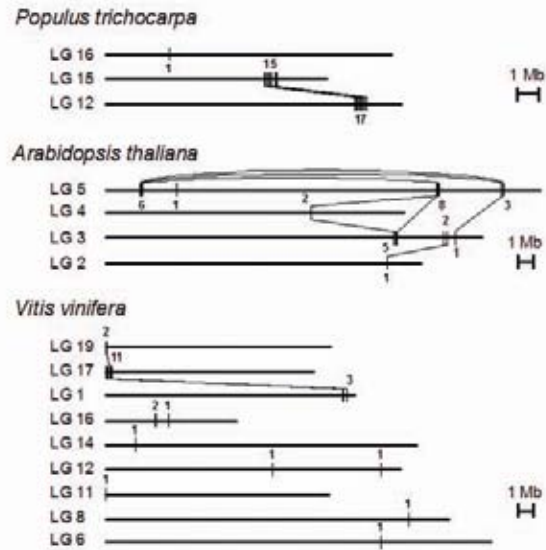

Figure 2 Chromosome mapping of poplar, Arabidopsis and grapevine homologues of the 39B3 Citrus deleted genes. The first TBLASTX hit for each *Citrus* deleted gene with an E value cut-off < 10⁻⁵ is represented on linkage groups (LG) from *Populus trichocarpa*, *Arabidopsis thaliana* and *Vitis vinifera*. Homologues of Citrus genes were grouped into clusters in each species when the distance between them was shorter than 250 kb. Second and third hits are only represented when they are located in a previously identified cluster, and in this case are linked to the first hit by a line. The value on each cluster indicates the hit number of the cluster.

Gene arrangement and partial physical map of the 39B3 deletion

The closer microsynteny observed between the 39B3 deletion and the two duplicated homologous regions in poplar enabled to predict gene structure by direct inference of gene position from the *Populus* sequences. Two DNA sequences covering 700 kb along the *Populus* chromosomes 12 and 15, containing the genes homologous to the *Citrus* deleted candidates, were BLASTed against available *Citrus* BAC end sequences. A partial physical map containing 13 BACs systematically named B1 to B13 was provided by standard PCR of BAC end amplicons against BAC templates and *in silico* search of overlapping antiparallel ends (**Figures 3A, 3B**). The above results indicated that the microsynteny between *Citrus* and *Populus* genomes was high enough to predict gene arrangement and to build a partial physical map of a *Citrus* genomic segment of about 700 kb, as inferred from the length of poplar homologous regions.

Overall, the data indicated that the *Populus* genome is a useful model for comparative genomics and that can be used to characterize hemizygous deletions in *Citrus*.

The *Citrus* 39B3 deletion shows higher local gene colinearity with *Populus* than with *Arabidopsis*.

We also mapped by PCR the 21 putative deleted genes on the physical map of **Figure 4A, 4B**. These results indeed confirm high local gene colinearity with poplar in the genomic region covered by 39B3 deletion.

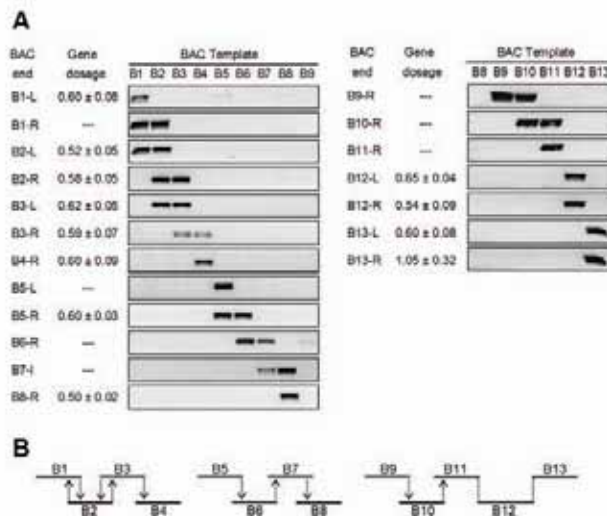

Figure 3 Local physical mapping of the *Citrus* 39B3 deletion. **(A)** Electrophoretic analysis of PCR products showing overlapping BACs. Purified BAC templates are distributed horizontally and divided in two panels. Primer pairs were designed from BAC end sequences containing non-repetitive DNA and named with the number of the BAC plus “-L” for left end and “-R” for right end according to the drawing orientation. B7-L primers amplify an internal sequence from B7 instead of an end. Gene dosage measurements for some of the primer pairs in the 39B3 genotype are shown on the left side of the electrophoretic images. **(B)** Physical map of the *Citrus* 39B3 deletion. Horizontal lines represent BACs, which are numbered from left to right. Vertical arrows show overlapping as inferred from PCR reactions and the head of the arrow indicates the BAC template. The vertical lines without arrow show connection of B11 with B12 by sequence of unigene aCL4690Contig1 and B12 with B13 by aCL1915Contig2 instead of a PCR reaction.

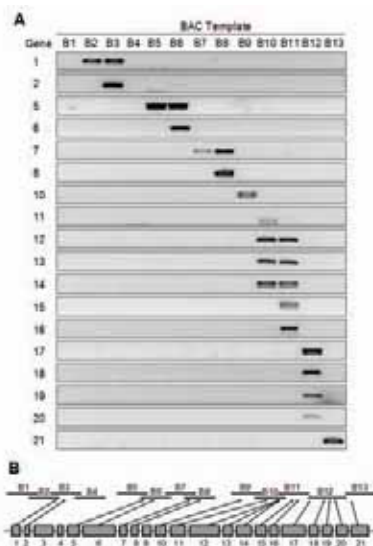

Figure 4 Gene arrangement on the physical map of the *Citrus* 39B3 deletion. **(A)** Primer pairs designed for the putative deleted genes included in the 39B3 deletion (**Table 2**) were utilized in PCR reactions on the BAC templates shown in **Table 3**. Genes are numbered and arranged vertically, on the left side of the electrophoretic image, and BAC templates are listed horizontally. **(B)** *Citrus* genes included in the 39B3 deletion and arranged as drawn previously but without indication of strand sense, are connected with arrows to the deletion physical map according to PCR results.

Taking together gene content and order conservation, it is inferred that in the studied DNA deleted segment there was higher gene colinearity with *Populus*, which diverged about 109 million years ago (Mya), than with *Arabidopsis*, splitting from the *Citrus* lineage about 87 Mya, despite gene colinearity is generally correlated with phylogenetic closeness. In papaya, BES alignment to the annotated genomes rendered higher gene colinearity with *Populus* than with *Arabidopsis*, although both *Arabidopsis* and papaya belong to the order Brassicales. In melon, microsynteny studies based on the sequence of two BACs also concluded that melon was closer to *Populus* than to *Arabidopsis* or *Medicago truncatula*. These observations may be explained by a differential genome evolutionary dynamics in poplar and *Arabidopsis* lineages. The more recent appraisals estimated that last whole genome duplications occurred not later than 60-65 Mya in *Populus* and around 24-40 Mya in *Arabidopsis* lineages. Despite the older poplar event, genome rearrangements involving gene loss and translocation following these duplications were much more frequent in *Arabidopsis* ancestors. Such a highly active genome dynamics probably caused the dispersion of genes and the subsequent reduction in synteny and gene colinearity with even related species. The different behavior of *Populus* and *Arabidopsis* ancestral genomes still deserves further explanation. It has been suggested that woody long-lived species like poplar trees may undergo a slower genome dynamics due to their juvenile period that delays sexual fecundation for several years and to the recurrent contribution of gametes from aged individuals of previous generations. In addition, species like *Arabidopsis thaliana* may have very active mechanisms for unequal or illegitimate recombination causing frequent chromosomal rearrangements such as translocations, insertions and deletions.

Chlorophyll *a/b* ratio is modified in 39B3 mutant

Among the deleted genes, one of the 39B3 hits validated by real-time quantitative PCR coding for a ClpC-like protein, may have certain relevance in the 39B3 phenotype. Plant ClpCs are ATP-binding proteins located in the stroma of chloroplasts, which have been found to be associated with the protein import machinery. In *Arabidopsis* a mutant impaired in *ClpC1* mRNA processing accumulated chlorophyllide *a* oxygenase protein (CAO), a key enzyme for the synthesis of chlorophyll *b* from chlorophyll *a*, leading to a reduced chlorophyll *a/b* ratio. Interestingly, 39B3 mutants also contained a lower ratio of chlorophyll *a/b* in young and old leaves and fruit exocarp.

Conclusions

In this study, we propose a procedure for the genetic characterization of genomic hemizygous deletions in mutants from plant species with non-sequenced genomes. The procedure is illustrated with the study of the 39B3 *Citrus clementina* deletion, generated by fast neutron bombardment. The proposed strategy utilizes several genomic resources such as array-Comparative Genomic Hybridization (array-CGH) technology, EST and BAC end sequencing databases and poplar genome annotation. The array-CGH results led to the conclusion that the 39B3 deletion removed at least 21 genes while a partial physical map of about 700 kb of the deleted region was inferred by comparison of two homologous genomic regions from poplar with a *Citrus* BES database. Structural data including gene content and order in the deletion was utilized for microsynteny and local gene colinearity studies concluding that in the studied region *Citrus* is more similar to *Populus* than to *Arabidopsis*, a phylogenetically closer species. This observation supports previous works on other species and suggests that *Arabidopsis* lineage underwent a quicker genome evolutionary dynamics than the *Populus* one.

ACKNOWLEDGEMENTS

Work at Centro de Genómica was supported by INIA grant RTA04-013, INCO contract 015453 and Ministerio de Educación y Ciencia grant

AGL2007-65437-C04-01/AGR. We also thank Dr. José Marqués at the Instituto Tecnológico e Nuclear (Sacavem, Portugal) for irradiation with fast neutrons. Help and expertise of A. Almenar, E Blázquez, I. López, I. Sanchis and M. Sancho are gratefully acknowledged.

BIBLIOGRAPHY

- Iglesias, D.J. *et al.* Physiology of citrus fruiting. *Braz J Plant Physiol*, 19, 333 (2007).
- Tadeo, F.R. *et al.* Molecular physiology of development and quality of citrus. *Adv Bot Res* (in press).
- Forment, J. *et al.* Development of a citrus genome-wide EST collection and cDNA microarray as resources for genomic studies. *Plant Mol. Biol.* **57**, 375 (2005).
- Terol, J. *et al.* Analysis of 13000 unique Citrus clusters associated with fruit quality, production and salinity tolerance. *BMC Genomics* **8**, 31 (2007).
- Bausher, M. *et al.* An expressed sequence tag (EST) set from *Citrus sinensis* L. Osbeck whole seedlings and the implications of further perennial source investigations. *Plant Sci.* **165**, 415 (2003).
- Shimada, T. *et al.* Expressed sequence tags of ovary tissue cDNA library in *Citrus unshiu* Marc. *Plant Sci.* **165**, 167 (2003).
- Fujii, H. *et al.*, Profiling ethylene-responsive genes in mature mandarin fruit using a citrus 22K oligoarray. *Plant Sci.* **173**, 340 (2007).
- Shimada, T. *et al.* Toward comprehensive expression profiling by microarray analysis in citrus: monitoring the expression profiles of 2213 genes during fruit development. *Plant Sci.* **168**, 1383 (2005).
- Lieu, P.T. *et al.* Development of a DNA-labeling system for array-based comparative genomic hybridization. *J. Biomol. Tech.* **16**, 104 (2005).
- Price, T.S. *et al.* SW-ARRAY: a dynamic programming solution for the identification of copy-number changes in genomic DNA using array comparative genome hybridization data. *Nucleic Acids Res.* **33**, 3455 (2005).
- Brown, P.O., Preparation of fluorescent DNA probe from HUMAN mRNA or total RNA using direct incorporation [http://cmgm.stanford.edu/pbrown/protocols/5_hyb_human.html].
- Giuntini, E. *et al.* Large-scale genetic variation of the symbiosis-required megaplasmid pSymA revealed by comparative genomic analysis of *Sinorhizobium meliloti* natural strains. *BMC Genomics* **6**, 158 (2005).
- NCBI BLAST HOME [<http://www.ncbi.nlm.nih.gov/blast/Blast.cgi>].
- Populus trichocarpa GENOME V1.1 BLAST PAGE [http://genome.jgi-psf.org/cgi-bin/runAlignment?db=Poptr1_1&advanced=1].
- GRAPE GENOME BLAST SERVER [http://www.genoscope.cns.fr/cgi-bin/blast_server/projet_ML/blast.pl].

Mutagenesis as a Functional Genomics Platform for Pharmaceutical Alkaloid Biosynthetic Gene Discovery in Opium Poppy

I Desgagne-Penix, J M Hagel & P J Facchini*

Abstract

Opium poppy (*Papaver somniferum*) accumulates the analgesic benzylisoquinoline alkaloids morphine, codeine and thebaine, and remains one of the world's most important medicinal plants. The development of varieties that accumulate valuable compounds, such as thebaine and codeine, but not morphine precludes the illicit synthesis of heroin (*O,O*-diacetylmorphine) and has led to the establishment of alternative cash crops. Novel cDNAs encoding a growing number of biosynthetic enzymes have been isolated, and various -omics resources including EST databases and DNA microarray chips have been established. However, the full potential of functional genomics as a tool for gene discovery in opium poppy remains limited by the relative inefficiency of genetic transformation protocols, which also restricts the application of metabolic engineering for both experimental and commercial purposes. We are establishing an effective functional genomics initiative based on induced mutagenesis and recently developed reverse genetics methodology, such as TILLING (Targeting Induced Local Lesions IN Genomes), with the aim of identifying biosynthetic genes that can be used to engineer opium poppy for the production of copious levels of high-value pharmaceutical alkaloids. Mutagenesis involves the treatment of seeds with ethyl methane sulfonate (EMS) or by fast-neutron bombardment (FNB). In preliminary experiments with EMS-treated seeds, the screening of 1,250 independent M₂ plants led to the isolation of four mutants that displayed two distinctly altered alkaloid profiles. Two lines accumulated the central pathway intermediate reticuline and relatively low levels of morphine, codeine and thebaine compared to wild-type plants. Two other lines showed the unusual accumulation in the latex of the antimicrobial alkaloid sanguinarine, which is the product of a branch pathway distinct from that leading to morphine. The present status of -omics resources and functional genomics platforms available to study benzylisoquinoline alkaloid biosynthesis in opium poppy are discussed with a focus on the applications of induced mutagenesis.

Introduction

Opium poppy (*Papaver somniferum*) has long been one of the world's most important medicinal plants due to its unique ability to synthesize the analgesic narcotics morphine, codeine and thebaine in addition to a variety of other biologically active benzylisoquinoline alkaloids (BIAs) such as papaverine, noscapine, and sanguinarine. Alkaloids produced in opium poppy, like many specialized plant metabolites, are structurally complex and most cannot be economically synthesized. The licit market for morphine is in excess of one million kilograms annually, the majority of which is chemically converted to codeine. The lower potency of codeine relative to morphine makes it a more versatile drug found in several over-the-counter – in some countries including Canada, Australia and New Zealand – and prescription medications, such as pain relievers and cough syrup [1]. However, opium poppy produces relatively low

quantities of codeine compared with morphine. The unfortunate side of this natural biochemistry is evident in the widespread and illegal cultivation of opium poppy for the production of heroin, which is derived via the relatively simple *O,O*-diacetylation of morphine. A thorough understanding of BIA biosynthesis in opium poppy provides an opportunity to customize the production of pharmaceuticals in metabolically engineered or mutagenized plants. Major targets are opium poppy varieties rich in thebaine, oripavine and codeine, but low in morphine. Thebaine and oripavine are feedstocks for the synthesis of valuable and powerful drugs, such as oxycodone (OxyContin), buprenorphine (Subutex), naloxone (Narcan) and naltrexone (ReVia), which are used as analgesics, and as a treatment for substance abuse and alcoholism. Paradigms established via an improvement of our knowledge of BIA biosynthetic pathways could also facilitate the metabolic engineering of other commercially or medically important plants.

Plant metabolic engineering typically involves the transfer of desired genes into the genome of a plant cell, followed by the regeneration of a transgenic plant from undifferentiated tissue. The genetic transformation of opium poppy has been reported, but remains a relatively difficult and inefficient procedure due primarily to recalcitrant regeneration [2–4]. With existing technology, opium poppy transformation protocols are applicable to research and development activities including the silencing and/or up-regulation of selected target genes, or the complementation of mutant varieties to confirm individual gene function. However, the establishment of a robust functional genomics platform and the rationale and comprehensive metabolic engineering of opium poppy will require a more reliable and efficient transformation system. An alternative to genetic transformation is the application of random and induced mutagenesis. A classic, *forward genetics* approach to acquiring plant lines with desired phenotypes involves the random mutagenesis of wild-type seeds using various chemical reagents or different forms of radiation. Such treatments generally introduce single nucleotide substitutions, whereas others cause deletions in the genome. Since some cells within each seed ultimately give rise to the next generation of seeds, the mutations in such cells are carried forward into future generations. The recent availability of myriad genomics resources for opium poppy facilitates the discovery of genes responsible for mutant phenotypes. Alternatively, mutations in genes of unknown function can be detected in plant genomes using recently established approaches, such as TILLING (Targeting Induced Local Lesions IN Genomes) [5]. The characterization of associated alterations in alkaloid phenotype facilitates the application of a potentially high-throughput, *reverse genetics* approach to gene discovery in opium poppy. In this paper, we discuss the prospects of using induced mutagenesis as a platform for both forward and reverse genetics in the context of BIA biosynthetic gene discovery in opium poppy.

Benzylisoquinoline alkaloid biosynthesis

BIA biosynthesis begins with the decarboxylation of tyrosine and dihydroxyphenylalanine (DOPA) by tyrosine decarboxylase (TYDC) to tyramine and dopamine, respectively (Fig. 1). TYDC constitutes

Department of Biological Sciences, University of Calgary, Calgary, Alberta T2N 1N4, Canada

* Corresponding author. E-mail: pfacchini@ucalgary.ca

require methylenedioxy bridge formation by a purported canadine synthase, an enzyme belonging to the Cyp719A family [25]. The remaining steps to noscapine formation are hypothetical [31] and represent novel targets for gene discovery.

Whereas all pathways downstream of reticuline begin with the (S)-epimer, conversion to the (R)-epimer of reticuline is a required entry step into the morphinan alkaloid biosynthetic pathway (Fig. 1). The epimerization of reticuline is a two-step process, involving oxidation of (S)-reticuline by 1,2-dehydroreticuline synthase (DRS) and subsequent formation to (R)-reticuline by 1,2-dehydroreticuline reductase (DRR). Both steps have been biochemically characterized and the enzymes partially purified [33,34]. Intramolecular carbon-carbon phenol coupling between C2 of the benzyl and C4 α of the isochinoline moiety leads to the formation of salutaridine. The enzyme catalyzing this reaction, salutaridine synthase (SalSyn) was shown to belong to the P450 monooxygenase family [35]. SalSyn was recently cloned from opium poppy based on its higher expression in morphine containing *Papaver* species and functionally characterized (J. Ziegler, personal communication). The protein shows high homology to methylenedioxy bridge-forming P450-dependent enzymes, and was classified as Cyp719B1. The next step in the pathway is catalyzed by salutaridine reductase (SalR), and a cognate cDNA was obtained via the same approach used for SalSyn isolation [36]. Functional characterization of the enzyme showed the stereospecific reduction of the keto group to 7(S)-salutaridinol [37]. The enzyme belongs to the family of short chain dehydrogenases/ reductases (SDR) but, unlike many other enzymes in this family, exhibits a higher molecular weight and is monomeric. Stereospecific reduction of salutaridine is required for the next step, which is catalyzed by salutaridinol 7-O-acetyltransferase (SalAT). This enzyme specifically acetylates the 7(S)-epimer of salutaridinol to salutaridinol-7-O-acetate [38]. With considerable sequence homology to the acetylating enzymes from the MIA pathway, SalAT also belongs to the BAHF family of acetyltransferases [39]. The introduced acetyl group is eliminated, either spontaneously or by thebaine synthase (THS) [40], leading to the formation of an oxide bridge between C4 and C5 to yield thebaine, the first pentacyclic alkaloid of the pathway. The final steps in morphine biosynthesis consist of two demethylations and one reduction. Both the demethylations of thebaine to neopinone, which isomerises to codeinone, and codeine to morphine are not yet understood. Codeinone reductase (COR), which converts codeinone to codeine and morphinone to morphine, belongs to the aldo-keto reductase family and has been purified and cloned from opium poppy [41,42].

Genomics resources and functional platforms

Mutagenesis is a powerful approach for (1) the creation of new traits and (2) the identification of new genes. Populations of mutagenized plants provide a biological basis for the application of both forward and reverse genetics. In forward genetics, phenotypic screening is used to isolate mutants of interest and various tools and techniques are used to isolate the responsible gene. For example, a mutant population of opium poppy could be screened for qualitative or quantitative alterations in alkaloid profile. Mutagenized plant populations can also be subjected to reverse genetics, whereby plants with mutations in a specific target gene are identified followed by characterization of the associated phenotype.

Several methods are available for the creation of a mutagenized population. Plant transformation is required to establish a library of transfer-DNA (T-DNA) and/or transposon-tagged lines [5]. However, the limited efficiency of genetic transformation protocols for opium poppy effectively precludes the use of insertional mutagenesis. In contrast, procedures relying on the mutagenic properties of certain chemicals or ionizing radiation do not require transformation and can be effectively applied in most if not all plant species.

A generalized workflow involving forward genetics approaches for

the purpose of gene discovery is illustrated in Fig. 2. Large populations of randomly mutagenized plants are first subjected to high-throughput phenotypic screening (i.e. metabolite profiling). Plants exhibiting phenotypes of interest are then subjected to further analysis aimed at identifying the mutated gene responsible for the observed traits. In plants where dense genetic maps or genomic sequence information are available, chromosome-walking techniques can be applied to narrow the search to a small region of the genome. Once the mutant phenotype has been linked with a relatively short genomic segment, BAC (bacterial artificial chromosome) or YAC (yeast artificial chromosome) clones harboring the DNA segment are used to narrow the search to a limited number of genes. Systematic expression of candidate genes in the mutant plant identifies the gene responsible based on the restoration of the wild-type phenotype.

In the case of opium poppy, mutants generated using chemicals or ionizing radiation can be screened for altered alkaloid profiles using high-throughput analytical methods (Fig. 2). However, genetic and physical maps are not yet available for opium poppy, precluding the use of chromosome-walking methodologies. Alternative measures, such as transcript profiling techniques (i.e. microarray analysis and comparative EST profiling) must be used to link a specific gene with an observed phenotype (Fig. 2). This strategy was used to isolate the *top1* mutant, (i.e. high levels of thebaine/oripavine and low levels of morphine/codeine) from a chemically mutagenized population [43]. Although it was proposed that *top1* harbors a mutation preventing the functional expression of an enzyme catalyzing the oxidative demethylation of thebaine and oripavine, comparative, microarray-based analysis of *top1* and its parent variety did not yield genes putatively involved in morphinan alkaloid biosynthesis.

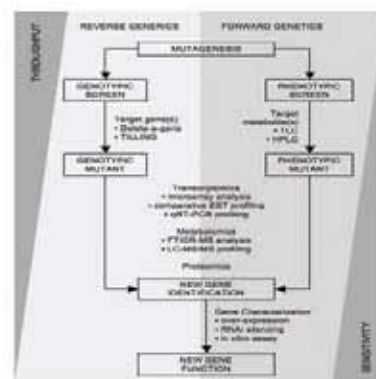

Figure 2 Generalized work-plan for forward and reverse genetics platforms to identify novel genes involved in benzylisoquinoline alkaloid biosynthesis using induced opium poppy mutants and various -omics resources.

Reverse genetics requires mutant populations for the purpose of isolating plants harboring specific genotypes rather than phenotypes. In model plants such as *Arabidopsis*, insertional mutants can be isolated using PCR-based methods. Briefly, primer sets designed against the T-DNA sequence and target gene regions are used to search for mutants with a target gene disrupted by a T-DNA insertion. In systems where insertional mutagenesis is not feasible, such as opium poppy, alternative approaches must be used for the genotypic screening of mutant populations, as illustrated in Fig. 2. Two screening methods are used, the choice of which depends on the mutagenesis procedure. Fast neutron bombardment (FNB) generally causes genomic deletions rather than nucleotide base transitions. To screen for deletion mutations in target genes, Delete-a-gene technology can be employed. This PCR-based approach involves screening pools of genomic DNA (gDNA) samples using primers flanking the target gene. The identification of deletions in specific

genes is improved by adjusting the PCR extension time to promote the preferential amplification of shorter amplicons [44,45].

In contrast, chemical mutagenesis with alkylating mutagens, such as ethylmethane sulfonate (EMS), causes point mutations. TILLING (Targeted Induced Local Lesions IN Genomes) is a high-throughput methodology used to screen pooled gDNA of chemically mutagenized plant populations to isolate nonsense or missense mutant alleles of target genes (Fig. 2) [46, 47]. Briefly, PCR is performed using fluorescently labelled and gene-specific primers, and the resulting amplicons are denatured and annealed. In gDNA pools where mutant alleles are represented, annealing of PCR products derived from wild-type and mutant alleles, respectively, leads to the formation of heteroduplexed DNA. Heteroduplexes are digested with the enzyme *Cel-1*, which is a nuclease specific for single-stranded DNA that recognizes mismatched base pairing. The fluorescent products are visualized after electrophoresis on denaturing polyacrylamide gels [5]. Generally, gDNA samples from M_2 plants are screened until an individual plant with a mutation in a target gene is identified. This plant and its progeny are then subjected to phenotypic analysis to determine gene function.

As illustrated in Fig. 2, genotypic mutants may be examined using targeted and broad-spectrum metabolite profiling based on, for example, liquid chromatography-tandem mass spectrometry (LC-MS/MS) or Fourier transform-ion cyclotron resonance mass spectrometry (FTICR-MS). Once a target gene has been identified using either forward or reverse genetics approaches, additional experiments must be performed to validate its function. For example, the gene can be heterologously expressed in bacterial or yeast systems and tested for enzymatic activity or other biological functions. Alternatively, post-transcriptional gene silencing (PTGS) techniques, such as RNA interference (RNAi) and virus-induced gene silencing (VIGS), can be used to characterize the function of candidate genes. Both RNAi and VIGS approaches have been used to investigate BIA biosynthesis in opium poppy. For example, RNAi was used to silence all members of the *COR* gene family (Fig. 1), which unexpectedly led to the accumulation of (*S*)-reticuline [48]. Similarly, RNAi suppression of *SalAT* resulted in the accumulation of salutaridine, the substrate of the enzyme immediately upstream of *SalAT* (Fig. 1) [49]. Both results suggest the occurrence of metabolic channels in BIA biosynthesis. Recently, the successful application of VIGS in opium poppy was reported [50], providing another tool for the characterization of gene function.

Integrated metabolomics

Underpinned by the tightly regulated expression of specific genes and the precise control of biosynthetic enzymes, plant metabolites are synthesized via an enormously complex biochemical network. Targeted phytochemical analysis has long been a basic component of plant metabolome research and modern approaches involving large-scale, broad-spectrum chemical profiling have facilitated the development of more complete and biologically meaningful metabolic models. As the final downstream product of the genome, the metabolome is defined as the total quantitative collection of low molecular weight compounds in a cell, tissue or organism [51]. The metabolome is chemically and physically more diverse than the transcriptome or proteome owing to large variations in molecular structures. Between 100,000 and 200,000 primary and secondary metabolites are estimated to occur in plants [52,53].

Metabolomics involves the use of high-throughput analytical strategies for the large-scale identification and quantification of metabolites [54]. A distinction is made between metabolomics and metabolite fingerprinting, which is used as a general sample classification tool and does not attempt to identify or quantify metabolites [55]. Both approaches require technologies capable of the rapid and comprehensive profiling of considerable numbers of compounds. Current analytical platforms include FTICR-MS and nuclear magnetic resonance (NMR) spectroscopy

[56]. The detection of up to several thousand analytes (i.e. distinct masses) has been possible using FTICR-MS [57–59]. FTICR-MS remains a popular method for metabolomics due to its sensitivity and resolution, although the detected analytes usually outnumber the actual metabolites in the sample, and identification is highly equivocal. In contrast with the limited chemical information provided by FTICR-MS, ^1H NMR has the general capacity for unequivocal metabolite identification. Unlike MS-based approaches, ^1H NMR does not discriminate against certain chemical classes, and provides detailed chemical and structural information for each compound in a sample. However, since biological samples typically contain a large proportion of metabolites at low concentrations, the low sensitivity of ^1H NMR poses a drawback. While both FTICR-MS and ^1H NMR circumvent problems associated with sample fractionation prior to analysis, general limitations in instrument availability and high costs have contributed to the widespread use of separation-based methods, such as liquid/gas chromatography (LC/GC)-MS and capillary electrophoresis (CE)-MS. Until sensitive instrumentation with the capacity for high-throughput sample processing and compound identification is developed, comprehensive metabolome surveys require a combination of available technologies.

The ability to assemble ‘snapshots’ of biochemical processes by cataloguing large numbers of metabolites has become a valuable tool for plant functional genomics. In spite of the vast compilation of genomic data for numerous plant species, reliable gene annotation and functional assignment remain difficult [60]. The search for novel genes in non-model plants (i.e. those for which genome sequences are not available) has created expansive libraries of ESTs the predicted functions of which are based on homology to previously characterized gene products. The use of EST and proteomic resources in opium poppy has led to the identification, cloning and *in vitro* characterization of numerous enzymes [7,13,26,36]. For the purpose of gaining insight into the biological roles of unknown enzymes, metabolomics platforms can be employed in the analysis of plants exhibiting mutations in target genes (i.e. reverse genetics). Conversely, mutant chemical phenotypes identified via forward genetics approaches can be more thoroughly characterized using metabolomics-based methods. Beginning with the screening of large mutant populations, plants exhibiting potentially desirable chemotypes can be selected for more rigorous metabolite analysis (e.g. LC-MS/MS). Upon confirmation of the select phenotype (e.g. high codeine, high/low overall alkaloid levels) more detailed, broad-scope metabolite profiling can be performed, acquiring datasets, which can then be integrated with transcriptomic and/or proteomic methods to identify the genes whose mutation underlies the observed phenotype. A typical workflow involving the use of metabolomics for gene discovery in opium poppy is shown in Fig. 3.

Metabolomics has been used for mutant classification, the characterization of stress responses and plant-herbivore interactions, and the assignment of species and cultivars [61,62]. As an integral component of our functional genomics program, we have applied both FTICR-MS and ^1H NMR metabolomics to investigate metabolism in opium poppy. Alkaloid biosynthesis and accumulation are generally organ- and cell type-specific processes in plants. Sanguinarine typically accumulates in roots, whereas morphine, papaverine and noscapine are generally the most abundant alkaloids in aerial organs [63]. Most alkaloids accumulate in the multinucleate cytoplasm (i.e. latex) of articulated, secretory cells known as laticifers that form an internal secretory system under a positive turgor pressure similar to sieve elements [64,65]. Dedifferentiated opium poppy cell cultures do not constitutively accumulate alkaloids, but instead produce sanguinarine in response to treatment with a fungal elicitor [66]. Inducible sanguinarine production in opium poppy cell cultures is an excellent platform to characterize the activation of BIA pathways under controlled conditions. EST databases and DNA microarrays are among the genomics resources now available to discover new

alkaloid biosynthetic genes and relevant biological processes.

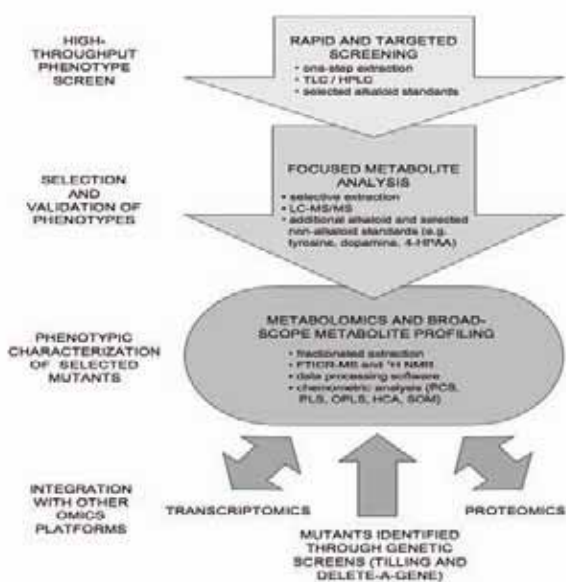

Figure 3 Workflow diagram showing methodologies and technical platforms used for different analytical approaches in metabolomics. Abbreviations and explanations are found in the text.

We have used FTICR-MS to show that substantial modulations in the metabolome of elicitor-treated opium poppy cell cultures are accompanied by major alterations in the transcriptome [59]. Several metabolites could be identified from 992 monoisotopic masses, including sanguinarine, dihydrosanguinarine, the methoxylated derivatives dihydrochelirubine and chelirubine, and the alkaloid pathway intermediates *N*-methylcoclaurine, *N*-methylstylopine, and protopine. The value of FTICR-MS for new compound discovery was demonstrated by the detection of low levels of chelirubine and papaverine, which were previously not reported in opium poppy cell cultures. Metabolite profiles of elicitor-treated cell cultures at most time points were distinctly separated by PCA, and some of the detected analytes exhibited temporal changes in abundance consistent with modulations in the profiles of alkaloid biosynthetic gene transcripts. The temporal shift in the accumulation of successive alkaloid intermediates in sanguinarine biosynthesis reflects biochemical flux through the pathway, with detectable intermediates representing potential regulatory bottlenecks.

In addition to FTICR-MS, ¹H NMR was used as a complementary approach to examine the metabolic response of opium poppy cell cultures to elicitor treatment [67]. Extensive reprogramming of primary metabolism along with an induction of alkaloid biosynthesis was seen using metabolite fingerprinting and compound-specific profiling. The levels of 42 diverse metabolites were monitored over a 100-hour period in control and elicitor-treated cultures. This approach permitted an impressive 70% success rate in the assignment of an absolute or relative quantity for 212 target compounds in the opium poppy cell culture metabolome. Combined with multivariate statistical analysis, targeted profiling revealed dynamic changes to the metabolome of elicitor-treated cells, especially in the cellular pools of sugars, organic acids and non-protein amino acids within 5 hours following elicitation. Substantial modulations were also observed in the metabolome of control cultures, particularly in the levels of amino acids and phospholipid pathway intermediates 80 hours after the start of the time course. Various flux modulations in primary metabolism were detected, such as glycolysis, the tricarboxylic acid cycle, nitrogen assimilation, phospholipid/fatty

acid synthesis and the shikimate pathway, all of which provide precursors for specialized metabolism. Although both approaches were corroborative, more compounds were unambiguously identified using ¹H NMR compared with FTICR-MS.

Table 1. Examples of opium poppy 'mutants' with diverse alkaloid content

Phenotype	Variety	Reference
Alkaloid-free	Sujata	[75]
Low-morphine	Przemko	[72]
	Michalko	http://www.ihar.poznan.pl/mak2.htm
High-thebaine	Mieszko	http://www.ihar.poznan.pl/mak2.htm
	Norman (top1)	[43]
High-codeine	Thebaine-rich	[73,74]
	SGE-29	[76]
	T	[68]
High-morphine	SG-35-I	[76]
	SG-35-II	[76]
	SGE-48	[76]
	SGE-9	[76]
High-noscapine	Lazur	http://www.ihar.poznan.pl/mak2.htm
	Shweta	[75]
	Sanchita	[76]
	SN-2	[76]
	SE-1	[76]
High-alkaloid	A1	[76]
	Kheops	[72]
	Kek Gemona	[72]
High-alkaloid	Marianne	[71]
	Monaco	[72]
High-alkaloid	Tebona	[72]
	C048-6-14-64	[71]

NMR-based targeted profiling was also used to examine metabolism in latex and root tissues of mature opium poppy plants [68]. Previous examination of benzyloquinoline alkaloid biosynthesis in poppy seedlings employed ESI-coupled MS_n and FTICR-MS techniques [69], and about 20 alkaloids were identified after feeding ¹³C-labeled tyramine. In contrast, our ¹H NMR analysis was aimed at acquiring a more broad-scope perspective of the metabolome of natural poppy mutants, and was not restricted to alkaloids. Several varieties were screened to identify six candidates with unique alkaloid phenotypes. Proton NMR was performed on aqueous and chloroform extracts, and chemometric methods were used to compare the resulting spectra. Two mutants, including a low-alkaloid variety and a high-thebaine, low-morphine line, were clearly distinguished by multivariate analysis of the spectra acquired for latex extracts. We quantified 34 root and 21 latex metabolites and revealed significant differences in the accumulation of specific alkaloids in the latex of the low-alkaloid and high-thebaine, low-morphine varieties. Interestingly, few significant differences were observed in the levels of other metabolites, suggesting that the variation was restricted to alkaloid metabolism. This result was supported by quantitative real-time polymerase chain reaction (qRT-PCR) analysis of 42 genes involved in both primary and specialized metabolism, showing specifically that differential gene expression was largely associated with alkaloid biosynthesis. In exception to these trends, modulations in primary metabolism were evidenced by an accumulation of the alkaloid precursor tyramine in the low-alkaloid cultivar, along with reduced levels of sucrose, some

amino acids and malate. The metabolomics platform established by NMR for these natural mutants has allowed the rational design of comparative, DNA-microarray analysis of alkaloid biosynthesis in low-morphine (or low-alkaloid) plants versus high-morphine commercial cultivars. Lists of candidate genes putatively involved in morphine metabolism are now available for further study (J. Hagel and P. Facchini, unpublished data).

Mutants and mutagenesis

There are many different mutants of opium poppy, which are generally referred to as varieties or cultivars. Most have been selected through classical breeding on the basis of agronomically and ornamentally desirable traits (e.g. floral morphology and color, capsule size, resistance to environmental stress or pathogen challenge, seed oil content of seeds, and alkaloid content) (Table 1). For example the morphological mutant variety ‘hens-and-chicks’ displays a capsule phenotype whereby the base of one large central capsule is surrounded by a cluster of smaller capsules. Another example is the variety ‘giganteum,’ which produces large flowers and enormous capsules. In terms of alkaloid content, the cultivar ‘Marianne’ contains high levels of noscapine and narcotoline, in addition to morphinan alkaloids [68,70,71]. In contrast, cultivar ‘Przemko’ has a low overall alkaloid content [68,72] (Table 1). A natural mutant with reddish latex containing substantially higher levels of thebaine compared with morphine has been described [73,74] (Table 1). Natural and induced variations in opium poppy morphology and alkaloid profile almost certainly result from mutations in the genome.

Random genetic mutations occur spontaneously or can be induced using ionizing radiation or certain chemicals. Highly energetic particles (e.g. β -particles, neutrons and α -particles) or electromagnetic wavelengths can damage DNA. For example, fast neutron bombardment (FNB) induces mutation by deleting large regions of the genome leading to loss-of-function (i.e. knock-out) of genes located in those regions [44,45]. In contrast, chemical mutagenesis is much more localized and typically results in point mutations whereby one nucleotide is substituted with another. For example the chemical mutagen ethyl methanesulfonate (EMS) causes guanine alkylation leading to a transition-type mutation of the original G:C base pair, resulting in the formation of an A:T pair [77]. As such, chemical mutagenesis produces four types of mutation: (1) silent (i.e. occurring in an intron or non-coding sequence), (2) neutral (i.e. nucleotides change, but encode the same amino acid), (3) nonsense (e.g. introduction of a premature stop codon leading to a truncated protein), or (4) missense (i.e. a single nucleotide transition results in the substitution of a key amino acid). The latter two events can render the protein non-functional, or can alter the original function. Historically, opium poppy has been a popular target for mutagenesis using chemical alkylating agents and/or ionizing radiation [75,78–84]. For example, treatment of several generations of opium poppy seeds with gamma rays and EMS led to the isolation of mutants with variations in capsule dimension and morphine content [81,83]. More recently, EMS treatment produced the *top1* mutant, which accumulates thebaine and oripavine, but not morphine [43].

We treated 100,000 opium poppy seeds with 0.6% (v/v) EMS for 16 hours and promoted self-pollination to produce a M_1 seeds stock. The germination frequency in the field of the M_0 seed was approximately 15% resulting in the production of approximately 10,000 plants. From the seed obtained 10,000 M_1 plants were grown to maturity under self-pollinating conditions. A total of 1,250 dried and milled capsule samples were extracted using methanol and alkaloid profiles were determined by thin layer chromatography. Two alkaloid phenotype mutants were identified as shown in Fig. 4. One mutant (i.e. 2944) accumulated the central pathway intermediate reticuline and relatively low levels of morphine, codeine and thebaine compared with wild-type plants. Among other explanations, this alkaloid phenotype could result from modulation in the function of a putative transcriptional regulator controlling the

expression of genes encoding biosynthetic enzymes acting on reticuline, the efficiency of a transporter responsible for the trafficking of reticuline to appropriate cellular compartments for further metabolism, or the catalytic activity of specific enzymes. Another mutant (i.e. 2650) showed the unusual accumulation in the latex of the antimicrobial alkaloid sanguinarine, which is the product of a branch pathway distinct from that leading to morphine. Available –omics resources provide opportunities to identify the genetic and biochemical basis for these interesting mutations in alkaloid phenotype.

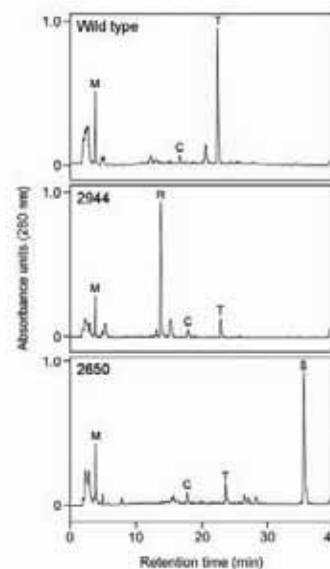

Figure 4 Mutants detected among 1,250 EMS-treated M_2 opium poppy plants. Abbreviations: C, codeiene; M, morphine; T, thebaine; R, reticuline, S, sanguinarine.

Future prospects

The ability to genetically engineer benzylisoquinoline alkaloid biosynthesis in opium poppy is highly desirable for myriad scientific, economic and social reasons. Plants produce a multitude of natural products, yet relatively little is known about the fundamental mechanisms that regulate the various biosynthetic pathways. In addition to various practical applications, the manipulation of specialized metabolic pathways via induced mutagenesis and genetic engineering offers a powerful tool to investigate the basic control mechanisms that regulate metabolic flux. The integration of the expanding repository of –omics resources with functional genomics strategies based on induced mutagenesis in opium poppy will substantially advance our knowledge of pharmaceutical alkaloid metabolism in this important medicinal plant. From an economic perspective, opium poppy, despite its notoriety, is a legal crop in many countries for the production of pharmaceutical morphine, codeine and other pharmaceuticals.

The development of technologies that emerge from this research could be licensed to opium poppy producers in other parts of the world. Moreover, opium poppy and related medicinal plant species could be developed into alternative crops in both developed and developing nations. Farmers in many countries need alternatives to commodity crops to remain competitive in an expanding global market. Genetic and metabolic engineering technologies offer immense potential to address these issues. Morphine produced from opium poppy is also the source of heroine, a narcotic drug with devastating social implications. Biotechnology must be considered an important weapon in the control of illicit drug trafficking. For example, drug cartels exploit poor farmers in developing countries for the production of the raw material from

opium poppy. One of the reasons that it is difficult to stem the supply of heroin coming out of Afghanistan, for example, is because the illicit cultivation of opium poppy offers farmers a higher financial return than the cultivation of commodity crops. Blocking alkaloid biosynthesis at codeine or thebaine could provide farmers around the world with a valuable crop with an alternative, licit market. However, successful implementation of any technological achievement requires political and socio-economic cooperation.

BIBLIOGRAPHY

- Hagel, J., Macleod, B.P., Facchini, P.J. (2007) "Opium poppy", *Biotechnology in Agriculture and Forestry: Tropical Crops II*, (PUA E.C and DAVEY M.R., Eds.), Springer-Verlag, Heidelberg, Germany, p.169–187.
- Park, S-U., Facchini, P.J. Agrobacterium-mediated transformation of opium poppy, *Papaver somniferum* L., via shoot organogenesis. *J. Plant Physiol* **157**, 207–214 (2000).
- Chitty, J.A., Allen, R.S., Fist, A.J., Larkin, P.J. Genetic transformation in commercial Tasmanian cultivars of opium poppy, *Papaver somniferum*, and movement of transgenic pollen in the field. *Funct. Plant Biol.* **30**, 1045–1058 (2003).
- Facchini, P.J., Loukanina, N., Blanche, V. Genetic transformation via somatic embryogenesis to establish herbicide-resistant opium poppy. *Plant Cell Rep.* **19**, 421–426 (2008).
- Comai, L., Henikoff, S. TILLING: practical single-nucleotide mutation discovery. *Plant J.* **45**, 684–694 (2006).
- Facchini, P.J., De Luca, V. Differential and tissue-specific expression of a gene family for tyrosine/dopa decarboxylase in opium poppy. *J. Biol. Chem.* **269**, 26684–26690 (1994).
- Liscombe, D.K., Macleod, B.P., Loukanina, N., Nandi, O.I., Facchini, P.J. Evidence for the monophyletic evolution of benzyloquinoline alkaloid biosynthesis in angiosperms. *Phytochemistry* **66**, 1374–1393 (2005).
- Samanani, N., Facchini, P.J. Purification and characterization of norcoclaurine synthase. The first committed enzyme in benzyloquinoline alkaloid biosynthesis in plants. *J. Biol. Chem.* **277**, 33878–33883 (2002).
- Samanani, N., Liscombe, D.K., Facchini, P.J. Molecular cloning and characterization of norcoclaurine synthase, an enzyme catalyzing the first committed step in benzyloquinoline alkaloid biosynthesis. *Plant J.* **40**, 302–313 (2004).
- Luk, L.Y., Bunn, S., Liscombe, D.K., Facchini, P.J., Tanner, M.E. MECHANISTIC studies on norcoclaurine synthase of benzyloquinoline alkaloid biosynthesis: an enzymatic Pictet-Spengler reaction. *Biochemistry* **46**, 10153–10161 (2007).
- Minami, H., Dubouzet, E., Iwasa, K., Sato, F. Functional analysis of norcoclaurine synthase in *Coptis japonica*. *J. Biol. Chem.* **282**, 62774–62782 (2007).
- Morishige, T., Tsujita, T., Yamada, Y., Sato, F. Molecular characterization of the S-adenosyl-L-methionine:3'-hydroxy-N-methylcoclaurine 4'-O-methyltransferase involved in isoquinoline alkaloid biosynthesis in *Coptis japonica*. *J. Biol. Chem.* **275**, 23398–23405 (2000).
- Ounaron, A., Decker, G., Schmidt, J., Lottspeich, F., Kutchan, T.M. (R,S)-Reticuline 7-O-methyltransferase and (R,S)-norcoclaurine 6-O-methyltransferase of *Papaver somniferum* – cDNA cloning and characterization of methyltransfer enzymes of alkaloid biosynthesis in opium poppy. *Plant J.* **36**, 808–819 (2003).
- Ziegler, J., Diaz-Chávez, M.L., Kramell, R., Ammer, C., Kutchan, T.M. Comparative macroarray analysis of morphine containing *Papaver somniferum* and eight morphine free *Papaver* species identifies an O-methyltransferase involved in benzyloquinoline biosynthesis. *Planta* **222**, 458–471 (2005).
- Choi, K.B., Morishige, T., Shitan, N., Yazaki, K., Sato, F. Molecular cloning and characterization of coclaurine N-methyltransferase from cultured cells of *Coptis japonica*. *J. Biol. Chem.* **277**, 830–835 (2002).
- Facchini, P.J., Park, S.U. Developmental and inducible accumulation of gene transcripts involved in alkaloid biosynthesis in opium poppy. *Phytochemistry* **64**, 177–186 (2003).
- Pauli, H.H., Kutchan, T.M. (1998) Molecular cloning and functional heterologous expression of two alleles encoding (S)-N-methylcoclaurine 3'-hydroxylase (Cyp80B1), a new methyl jasmonate-inducible cytochrome P450-dependent monooxygenase of benzyloquinoline alkaloid biosynthesis. *Plant J.* **13**, 793–801.
- Huang, F.C., Kutchan, T.M. Distribution of morphinan and benzof[phenanthridine] alkaloid gene transcript accumulation in *Papaver somniferum*. *Phytochemistry* **53**, 555–564 (2000).
- Kraus, P.F., Kutchan, T.M. Molecular cloning and heterologous expression of a cDNA encoding berbamunine synthase, a C-O phenol-coupling cytochrome P450 from the higher plant *Berberis stolonifera*. *Proc. Natl. Acad. Sci. USA* **92**, 2071–2075 (1995).
- Dittrich, H., Kutchan, T.M. Molecular cloning, expression, and induction of berberine bridge enzyme, an enzyme essential to the formation of benzophenanthridine alkaloids in the response of plants to pathogenic attack. *Proc. Natl. Acad. Sci. USA* **88**, 9969–9973 (1991).
- Facchini, P.J., Penzes, C., Johnson, A.G., Bull, D.) Molecular characterization of berberine bridge enzyme genes from opium poppy. *Plant Physiol.* **112**, 1669–1677 (1996).
- Samanani, N., Park, S.U., Facchini, P.J. Cell type-specific localization of transcripts encoding nine consecutive enzymes involved in protoberberine alkaloid biosynthesis. *Plant Cell* **17**, 915–926 (2005).
- Winkler, A., Hartner, F., Kutchan, T.M., Glieder, A., Macheroux, P. Biochemical evidence that berberine bridge enzyme belongs to a novel family of flavoproteins containing a bi-covalently attached FAD cofactor. *J. Biol. Chem.* **281**, 21276–21285 (2006).
- Winkler, A., Kutchan, T.M., Macheroux, P. 6-S-cysteinylation of bi-covalently attached FAD in berberine bridge enzyme tunes the redox potential for optimal activity. *J. Biol. Chem.* **282**, 24437–24443 (2007).
- Ikezawa, N., Iwasa, K., Sato, F. Molecular cloning and characterization of methylenedioxy bridge-forming enzymes involved in stylopine biosynthesis in *Eschscholzia californica*. *Febs J.* **274**, 1019–1035 (2007).
- Liscombe, D.K., Facchini, P.J. Molecular cloning and characterization of tetrahydroprotoberberine cis-N-methyltransferase, an enzyme involved in alkaloid biosynthesis in opium poppy. *J. Biol. Chem.* **28**, 14741–14751 (2007).
- Rueffer, M., Zenk, M.H. Enzymatic formation of protopines by a microsomal cytochrome P450 system of *Corydalis vaginans*. *Tetrahedron Lett.* **28**, 5307–5310 (1987).
- Tanahashi, T., Zenk, M.H. Elicitor induction and characterization of microsomal protopine-6-hydroxylase, the central enzyme in benzophenanthridine alkaloid biosynthesis. *Phytochemistry* **29**, 1113–1122 (1990).
- Arakawa, H., Clark, W.G., Psenak, M., Coscia, C.J. Purification and characterization of dihydrobenzophenanthridine oxidase from elicited *Sanguinaria canadensis* cell cultures. *Arch. Biochem. Biophys.* **299**, 1–7 (1992).
- WEISS, D., BAUMERT, A., VOGEL, M., ROOS, W. Sanguinarine reductase, a key enzyme of benzophenanthridine detoxification. *Plant Cell Environ.* **29**, 291–302 (2007).
- Facchini, P.J., Hagel, J.M., Liscombe, D.K., Loukanina, N., Macleod, B.P., Samanani, N., Zulak, K.G. Opium poppy: blueprint for an alkaloid factory. *Phytochemistry Rev.* **6**, 97–124 (2005).
- Takeshita, N., Fujiwara, H., Mimura, H., Fitch, J.H., Yamada, Y., Sato, F. Molecular cloning and characterization of S-adenosyl-L-methionine:scolerine-9-O-methyltransferase from cultured cells of *Coptis japonica*. *Plant Cell Physiol.* **36**, 29–36 (1995).
- De-Eknamkul, W., Zenk, M.H. Purification and properties of 1,2-dehydroreticuline reductase from *Papaver somniferum* seedlings. *Phytochemistry* **31**, 813–821 (1992).
- Hirata, K., Poeaknapo, C., Schmidt, J., Zenk, M.H. 1,2-Dehydroreticuline synthase, the branch point enzyme opening the morphinan biosynthetic pathway. *Phytochemistry* **65**, 1039–1046 (2004).
- Gerardy, R., Zenk, M.H. Purification and characterization of salutaridine: NADPH 7-oxidoreductase from *Papaver somniferum*. *Phytochemistry* **34**, 125–132 (1993).
- Ziegler, J., Voigtländer, S., Schmidt, J., Kramell, R., Miersch, O., Ammer, C., Gesell, A., Kutchan, T.M. Comparative transcript and alkaloid profiling in *Papaver* species identifies a short chain dehydrogenase/reductase involved in morphine biosynthesis. *Plant J.* **48**, 177–192 (2006).
- Gerardy, R., Zenk, M.H. Purification and characterization of salutaridine:NADPH 7-oxidoreductase from *Papaver somniferum*. *Phytochemistry* **34**, 125–132 (1993).
- Lenz, R., Zenk, M.H. Acetyl coenzyme A:salutaridinol-7-O-acetyltransferase from *Papaver somniferum* plant cell cultures. The enzyme catalyzing the formation of thebaine in morphine biosynthesis. *J. Biol. Chem.* **270**, 31091–31096 (1995).
- Grothe, T., Lenz, R., Kutchan, T.M. Molecular characterization of the salutaridinol 7-O-acetyltransferase involved in morphine biosynthesis in opium poppy *Papaver somniferum*. *J. Biol. Chem.* **276**, 30717–30723 (2001).
- Fisinger, U., Grobe, N., Zenk, M.H. Thebaine synthase: a new enzyme in the morphine pathway in *Papaver somniferum*. *Nat. Prod. Commun.* **2**, 249–253 (2007).

41. Lenz, R., Zenk, M.H. Purification and properties of codeinone reductase (NADPH) from *Papaver somniferum* cell cultures and differentiated plants. *Eur. J. Biochem.* **233**, 132–139 (1995).
42. Unterlinner, B., Lenz, R., Kutchan, T.M. Molecular cloning and functional expression of codeinone reductase: the penultimate enzyme in morphine biosynthesis in the opium poppy *Papaver somniferum*. *Plant J.* **18**, 465–475 (1999).
43. Millgate, A.G., Pogson, B.J., Wilson, I.W., Kutchan, T.M., Zenk, M.H., Gerlach, W.L., Fist, J., Larkin, P.J. Analgesia: morphine-pathway block in *top1* poppies. *Nature* **431**, 413–414 (2004).
44. Li, X., Zhang, Y. Reverse genetics by fast neutron mutagenesis in higher plants. *Funct. Integr. Genomics* **2**, 254–258 (2002).
45. Li, X., Lassner, M., Zhang, Y. Deleteagene: a fast neutron deletion mutagenesis-based gene knockout system for plants. *Comp. Funct. Genomics* **3**, 158–160 (2002).
46. McCallum, C.M., Comai, L., Greene, E.A., Henikoff, S. Targeting induced local lesions in genomes (TILLING) for plant functional genomics. *Plant Physiol.* **123**, 439–442.
47. Colbert, T., Till, B.J., Tompa, R., Reynolds, S., Steine, M.N., Yeung, A.T., McCallum, C.M., Comai, L., Henikoff, S. High-throughput screening for induced point mutations. *Plant Physiol.* **126**(2), 480–484 (2001).
48. Allen, R.S., Millgate, S.G., Chitty, J.A., Thisleton, J., Miller, J.A., Fist, A.J., Gerlach, W.L., Larkin, P.J. RNAi-mediated replacement of morphine with the nonnarcotic alkaloid reticuline in opium poppy. *Nat. Biotechnol.* **12**, 1559–1566 (2004).
49. Allen, R.S., Miller, J.A.C., Chitty, J.A., Fist, A.J., Gerlach, W.L., Larkin, P.J. Metabolic engineering of morphinan alkaloids by over-expression and RNAi suppression of salutaridinol 7-O-acetyltransferase in opium poppy. *Plant Biotechnol. J.* **6**, 22–30 (2008).
50. Hillman, L.C., Drea, S., De Martino, G., Litt, A., Irish, V.F. Virus-induced gene silencing is an effective tool for assaying gene function in the basal eudicot species *Papaver somniferum* (opium poppy). *Plant J.* **44**, 334–341 (2005).
51. Dunn, W.B., Bailey, N.J.C., Johnson, H.E. Measuring the metabolome: current analytical technologies. *Analyst* **130**, 606–625 (2005).
52. Weckwerth, W. Metabolomics in systems biology. *Ann. Rev. Plant Biol.* **54**, 669–689 (2003).
53. Oksman-Caldentey, K.-M., Inzé, D. Plant cell factories in the post-genomic era: new ways to produce designer secondary metabolites. *Trends Plant Sci.* **9**, 433–440 (2004).
54. Last, R.L., Jones, A.D., Shachar-Hill, Y. Towards the plant metabolome and beyond. *Nat. Rev. Mol. Cell Biol.* **8**, 167–174 (2007).
55. Hall, R.D. Plant metabolomics: from holistic hope, to hype, to hot topic. *New Phytol.* **169**, 453–468 (2006).
56. Hagel, J., Facchini, P.J. Plant metabolomics: Analytical platforms and integration with functional genomics. *Phytochemistry Rev.* **7**, 479–497 (2008).
57. Aharoni, A., De Vos, R.C.H., Verhoeven, H.A., Maliepaard, C.A., Kruppa, G., Bino, R., Goodenowe, D.B. Nontargeted metabolome analysis by use of Fourier transform-ion cyclotron-mass spectrometry. *OMICS* **6**, 217–243 (2002).
58. Tohge, T., Nishiyama, Y., Hirai, M.Y., Yano, M., Nakajima, J., Awazuhara, M., Inoue, E., Takahashi, H., Goodenowe, D.B., Kitayama, M., Noji, M., Yamazaki, M., Saito, K. Functional genomics by integrated analysis of metabolome and transcriptome of Arabidopsis plants over-expressing an MYB transcription factor. *Plant J.* **42**, 218–235 (2005).
59. Zulak, K.G., Cornish, A., Daskalchuk, T., Deyholos, M., Goodenowe, D., Gordon, P., Klassen, D., Pelcher, L., Sensen, C., Facchini, P.J. Gene-transcript and metabolite profiling of elicitor-induced opium poppy cell cultures reveals the coordinate regulation of primary and secondary metabolism. *Planta* **225**, 1085–1106 (2007).
60. Provart, N.J., Mccourt, P. Systems approaches to understanding cell signaling and gene regulation. *Curr. Opin. Plant Biol.* **7**, 605–609 (2004).
61. Schauer, N., Fernie, A.R. Plant metabolomics: towards biological function and mechanism. *Trends Plant Sci.* **11**, 508–516.
62. Verpoorte, R., Choi, Y.H., Kim, H.K. (2007) NMR-based metabolomics at work in phytochemistry. *Phytochemistry Rev.* **6**, 3–14 (2006).
63. Facchini, P.J., De Luca, V. Phloem-specific expression of tyrosine/dopa decarboxylase genes and the biosynthesis of isoquinoline alkaloids in opium poppy. *Plant Cell* **7**, 1811–1821 (1995).
64. Hagel, J.M., Yeung, E.C., Facchini, P.J. Got milk? The secret life of laticifers. *Trends Plant Sci.* (in press) (2008a).
65. Thureson-Klein, A. Observations on the development and fine structure of the articulated laticifers of *Papaver somniferum*. *Ann. Bot.* **34**, 751–759 (1970).
66. Facchini, P.J., Johnson, A.G., Poupart, J., De Luca, V. Uncoupled defense gene expression and antimicrobial alkaloid accumulation in elicited opium poppy cell cultures. *Plant Physiol.* **111**, 687–697 (1996).
67. Zulak, K.G., Weljie, A., Facchini, P.J. Quantitative 1H NMR metabolomics reveals extensive reprogramming of primary and secondary metabolism in elicitor-treated opium poppy cell cultures. *BMC Plant Biol.* **8**, 5 (2008).
68. Hagel, J.M., Weljie, A.M., Vogel, H.J., Facchini, P.J. Quantitative 1H nuclear magnetic resonance metabolite profiling as a functional genomics platform to investigate alkaloid biosynthesis in opium poppy. *Plant Physiol.* **147**, 1805–1821 (2008).
69. Schmidt, J., Boettcher, C., Kuhnt, C., Kutchan, T.M., Zenk, M.H. Poppy alkaloid profiling by electrospray tandem mass spectrometry and electrospray FT-ICR mass spectrometry after [*ring*-¹³C₆]-tyramine feeding. *Phytochemistry* **68**, 189–202 (2007).
70. Williams, R.D., Ellis, B.E. Age and tissue distribution of alkaloids in *Papaver somniferum*. *Phytochemistry* **28**, 2085–2088 (1989).
71. Frick, S., Krammell, R., Schmidt, J., Fist, A.J., Kutchan, T.M. Comparative and quantitative determination of alkaloids in narcotic and condiment *Papaver somniferum* varieties. *J. Nat. Prod.* **68**, 666–673 (2005).
72. Bernath, J., Nemeth, E., Petheo, F. Alkaloid accumulation in capsules of the selfed and cross-pollinated poppy. *Plant Breeding* **122**, 263–267 (2003).
73. Nyman, U. Selection for high thebaine/low morphine content (cpv. *Morph:The*) in *Papaver somniferum* L. *Hereditas* **89**, 43–50 (1978).
74. Nyman, U. Selection for high thebaine/low morphine content in *Papaver somniferum* L. II. Studies of the I4 and I5 generations from a spontaneous mutant. *Hereditas* **93**, 121–124 (1980).
75. Sharma, J.R., Lal, R.K., Gupta, A.P., Misra, H.O., Pant, V., Singh, N.K., Pandey, V. Development of non-narcotic (opiumless and alkaloid-free) opium poppy, *Papaver somniferum*. *Plant Breeding* **118**, 449–452 (1999).
76. Srivastava, H.K., Singh, D. Honeybees foraging response in genetically diversified opium poppy. *Bioresource Technol.* **97**, 1578–1581 (2006).
77. Freese, E.B. Transitions and transversions induced by depurinating agents. *Proc. Nat. Acad. Sci. USA* **47**, 540–545 (1961).
78. Ivanova, R.M. The use of experimental mutagenesis in the breeding of the opium poppy. *Genetika* **8**, 30–37 (1972).
79. Floria, F.G., Ghiorghita, G.I. The influence of the treatment with alkylating agents on *Papaver somniferum* L. in M₁. *Rev. Roum. Biol.* **25**, 151–155 (1980).
80. Ghiorghita, G.I., Gille, E., Rosu, R. The morphine content – a selection criterion in obtaining some more productive forms of *Papaver somniferum* by means of experimental mutagenesis. I. Effects of the successive treatments with gamma rays and alkylating agents in the 4th generation. *Rev. Roum. Biochim.* **21**, 279–286 (1984).
81. Gille, E., Ghiorghita, G.I., Pinzaru, G. The effect of the treatments for three successive generations with gamma rays and alkylating agents on the morphine content of *Papaver somniferum* L. *Rev. Roum. Biol.* **30**, 73–78 (1985).
82. Ghiorghita, G.I., Gille, E., Paun, E.M., Toth, E.T. Some morphological and biochemical peculiarities of the *Papaver somniferum* L. plants of M₃ generation after mutagen treatments in M₁ and M₂. *Rev. Roum. Biol.* **31**, 41–49 (1986).
83. Floria, F.G., Gille, E., Miricioiu, E. The influence of some successive mutagenic treatments on the capsules dimensions and the morphine content of *Papaver somniferum* L. *Rev. Roum. Biochim.* **23**, 285–292 (1986).
84. Patra, N.K., Srivastava, H.K., Chauhan, S.P. B chromosomes in spontaneous and induced intercellular chromosome migration of *Papaver somniferum* L. *Indian J. Genet.* **48**, 31–42 (1988).

From Discovery of High Lysine Barley Endosperm Mutants in the 1960-70s to new Holistic Spectral Models of the Phenome and of Pleiotropy in 2008

L Munck* & B Møller Jespersen

Abstract

As documented by eight IAEA/FAO symposia (1968-82) on nutritionally improved seeds, a wide range of high lysine endosperm mutants were isolated in maize, sorghum and barley. These mutants observed by new spectroscopic screening methods can now be exploited to advance basic biological research and theory. Since 1982, effective methods to overview the physiochemical composition of seeds by Near Infrared Spectroscopy evaluated by chemometric data analysis have developed. Spectroscopic analyses by calibration have now substituted the wet analyses in the industry. In genetics there has traditionally been a differentiation between major genes for qualitative and minor "polygenes" for quantitative traits. This view has been coupled with an incomplete understanding of pleiotropy. It is shown that seed spectra from isogenic barley endosperm mutants represent a coarse-grained physiochemical overview of the phenome that can be classified by chemometrics. Pleiotropy expressed by a gene is quantified as a whole pattern by the gene specific mutant spectrum subtracted by the spectrum of the parent variety. Selection for an improved plumpness (starch) in a breeding material with the *lys3.a* mutant visualizes in spectra the effect of enriching "minor polygenes" for an increased content of starch in a mutant gene background. Morphological, spectroscopic and chemical analyses suggest that mutant genes have both qualitative and quantitative expressions. They produce qualitative pleiotropic phenomenological patterns that can be observed as more or less severe changes in macro and microstructures of the plant and seed phenotype. Behind are quantitative chemical changes that by spectroscopy and chemometrics can be transferred to qualitative patterns. In fact, one major gene for a qualitative trait can act as several apparent minor polygenes for quantitative variables. This explains the reduced need for the previously expected several hundred thousands of genes and gene modifiers down to the about 30,000 genes that are now sequenced in barley.

Introduction

The use of endosperm mutants to analyze the total integrated effect of gene expression in seeds.

From 1968 to 1982, the IAEA/FAO staff in Vienna arranged eight symposia on seed protein improvement by mutation that highly stimulated research in this area during that time. In another article, we have reviewed the practical outcome in agriculture and industry of some important achievements in this research (see IAEA-CN-167-301). Here, we will focus on how the high lysine endosperm mutants in barley that were identified during that time could be exploited to evolve improved spectroscopic methods and genetic theory for understanding and controlling gene expression. This research is now again in an active stage that is likely to have a fundamental impact on genetics and molecular biology in the future. The development started when the senior author

was involved in isolating the first high lysine barley mutant gene *lys1* in the Hiproly genotype at Svalöf, Sweden in 1967 [1,2]. As a screening method, a dye-binding (acilane orange) analysis for basic amino acids (lysine) was plotted against protein (N) in an x-y plot to select the outliers high in lysine. Doll and his group [3], working at the Risø National Laboratory, Denmark, then employed the dye-binding to protein (N) method to isolate a range of barley endosperm mutants in the 1970s including the very high lysine (+45%) mutant Risø 1508(*lys3.a*), as well as mutants with moderate to low increase in lysine such as the +20% mutant 8 (*lys4.d*) and Risø mutant 16, the alleles mutant 13 (*lys5.f*) and mutant 29 (*lys5.g*) that all are about +10% in lysine % 16/g N. The Risø mutant M-1508 (*lys3.a*) and the Hiproly *lys1*. genes were utilized at the Carlsberg Research Center, Copenhagen, Denmark in the 1970-90' s, in plant breeding [4] and for basic research. In Diter von Wettsteins group, the *lys3.a* was shown to be a regulatory gene [5] that inhibited synthesis of the hordeine proteins low in lysine by inducing a lack of demethylation of the promoter DNA for these genes. The electron micrographs [6] demonstrated in the *lys3.a* mutant a granular matrix of high lysine proteins that surrounded the endosperm protein bodies. They were drastically changed in size and microstructure (see Fig. 3B). The over-expression of water-soluble high lysine proteins in the two mutants was further investigated at Carlsberg in the group of the senior author in the 1970-90s by John Mundy, Robert Leah and Ib Jonassen [7]. Six high lysine seed proteins were identified. The first two, chymotrypsine inhibitor I and II, were over expressed in both *lys1* and in *lys3.a* phenotypes. The other four - a barley subtilisine alpha-amylase inhibitor, a protein synthesis inhibitor, a chitinase and a 1-3 β -glucanase - were greatly increased in *lys3.a*. The six proteins were surprisingly identified as inhibitors of bacterial and fungal growth [7,8]. The barley mutant research was thus instrumental in opening up a new understanding of how the germinated barley seed in the field and in the malt house could obtain immunity towards microbial infections. Another line of biochemical research with barley endosperm mutants has focused on identifying structural genes for starch synthesis [9]. ADP-glucose is the substrate for starch synthesis in plants. It is synthesized outside the plastid by ADP-glucose pyrophosphorylases (AGPases). AGPase is a main regulator of starch synthesis. Risø mutant 16 lacks one of the AGPase isoenzymes, while the alleles *lys5.g* and *lys5.f* lack activity in one of the ADP-glucose transporters bound to the plastid [9].

In 1991, the senior author started a new research group on chemometrics [10,11] and spectroscopy [11,12] at the Royal Agricultural University (now Life Science Faculty of University of Copenhagen). Here the barley endosperm mutant material from Risø, Carlsberg and Svalöf has been used as a test case for exploiting Near Infrared Reflectance (NIR) spectroscopy in plant breeding and in genetic research. The barley endosperm mutants evaluated by NIR spectroscopy can now for the first time be used to overview gene expression of specific endosperm genes in isogenic barley seed phenotypes with regard to physiochemical composition. The results facilitate a new complementary view on the theory of gene expression in Systems Biology [14].

Spectroscopy and Chemometrics Group, Quality and Technology, Department of Food Science, Life Science Faculty, University of Copenhagen, Frederiksberg, Denmark

* Corresponding author. E-mail: lmu@kvl.dk

Materials and Methods

The data set [13] consists of 92 endosperm mutant genotypes and normal barley controls grown in the field ($n=23$, **Fig. 1A, B, C, Fig. 2A**) and in the greenhouse ($n=69$, **Fig. 2B, Table 1**), and is described with spectroscopic and chemical analyses interpreted by chemometrics [10] and data inspection. The mutant Risø genotypes are the *lys3.a* (mutant 1508), *lys3.b* (mutant 18), *lys3.c* (mutant 19), *lys4.d* (mutant 8) mutant 16 and *lys5.f* (mutant 13) all in Bomi as well as *lys5.g* (mutant 29) in Carlsberg II. Mutants 95 and 449 in Perga are of Italian origin [13]. The *w1* (line 1201) and *w2* (line 841878) of unknown origin were imported to the Carlsberg collection assigned as *waxy* mutants [13]. Mutant *lys3.m* induced in Minerva originates from Carlsberg. Lysimax and Lysiba are starch and yield improved recombinants from crosses with *lys3.a* and normal barley from Carlsberg [4,12]. The chemical and Near Infrared Reflectance (NIR) spectral analysis (on milled flour 0.5mm sieve) was carried out by a Foss-NIRSystems (USA) 6500 instrument [12]. The raw spectra were Multiplicative Scatter Corrected (MSC) and presented as *log 1/R* absorption. Chemometric pattern recognition analysis was performed using Principal Component Analysis (PCA) for classification and Partial Least Squares Regression (PLSR) to chemical analyses for prediction [10].

Experimental: Recognizing sample and genotype specific NIRS patterns in barley seeds

The NIR spectra from the 23 barley seed sample in **Fig. 1A** depict 1400 wavelength variables with a seemingly narrow variation between samples in absorption value (MSC *log 1/R*). Classical statistics of variance based on distributional assumptions cannot extract information from such a complex whole inter-correlated data matrix with thousands of wavelength variables per sample. For this purpose, there is a need for self-modeling multivariate chemometric data models such as PCA for classification and PLSR for prediction based on latent variables. We found that the PCA in **Fig. 1B** calculated from the spectra in **Fig. 1A** differentiated between structural and regulative mutants and classified the spectra into three distinct populations: normal (N) barley, regulative endosperm (P) mutants with a high lysine percentage in protein and structural carbohydrate (C) mutants with low starch content. The C barley lines such as Risø mutant 16, *lys5.g* and *lys5.f*, that are structural starch mutations of DNA for the AGP-ase starch synthesis and transport mechanisms, have been used by the biochemists to study starch synthesis. It was therefore surprising when we found that these mutants and three others - mutant 95, mutant 449 and the *w1* (line 1201) were all placed in the C cluster (**Fig. 1B**) and that the loss of starch was largely compensated by an overproduction of β -glucan (BG). *w1* has earlier been wrongly classified as a *waxy* mutant but is a β -glucan compensating low starch mutant. *w2* is here classified, as normal barley, but is *waxy* and is high in amylopectin. It can be concluded that *lys4.d* is likely to be a regulative P mutant because it is classified together with the regulative mutant *lys3.a* [5] and its alleles *lys3.b*, *lys3.c* and *lys3.m* (**Fig. 1B**). The mean BG value for the C (12,3%), P (3,7%) and N (4,7%) classes are marked in **Fig. 1B**. Obviously, there is a strong pleiotropic regulative effect where mutations in starch metabolism may channel glucose from α - to β -glucan production [13].

PCA classifications, that are useful for an overview of large (spectral) data sets, are most often published in literature without inspecting the underlying data structure because the significance of individual spectra tends to be underrated in mathematical modeling. We generated the mean spectra for the C, P and N genotypes and visually screened the whole spectra. Marked differences were found in the narrow area 2260-2360 nm (**Fig. 1C** marked "a" in **Fig. 1A**) of chemical and genetic significance. The near infrared reflectance spectra (NIRS) represent in principle a physical-chemical fingerprint containing repetitive information on the propensity of chemical bonds [12]. A trained spectroscopist

can from the first, second derivatives or by MSC of the *log 1/R* NIRS data directly explore specific chemical differences between samples and deduce destructive chemical analyses for verification. The P and C genotypes have a characteristic bulb in the area from 2336 to 2352 nm which in spectroscopic literature is assigned to cellulose (2336 and 2352nm) and fat (2347nm). The substantial increases of the fat components anticipated from the mean spectral patterns of C and P barleys in **Fig. 1C** are verified by chemical analyses in **Table 1**. The reproducibility, fine-tuning and informative capacity of NIRS spectra are indeed impressive. The MSC *log 1/R* absorption range is 0.04 units for classification of C, P and N barleys in **Fig. 1B**. However, the range needed is 100 times less for classifying the C versus P+N groups in the 1890-1920nm area for dry matter content within the narrow response of 89-93% d.m. (Munck, 2007 p.412, 414, [14]). A high BG content of the C group conditions a mean difference in dry matter of 1.5% between these groups.

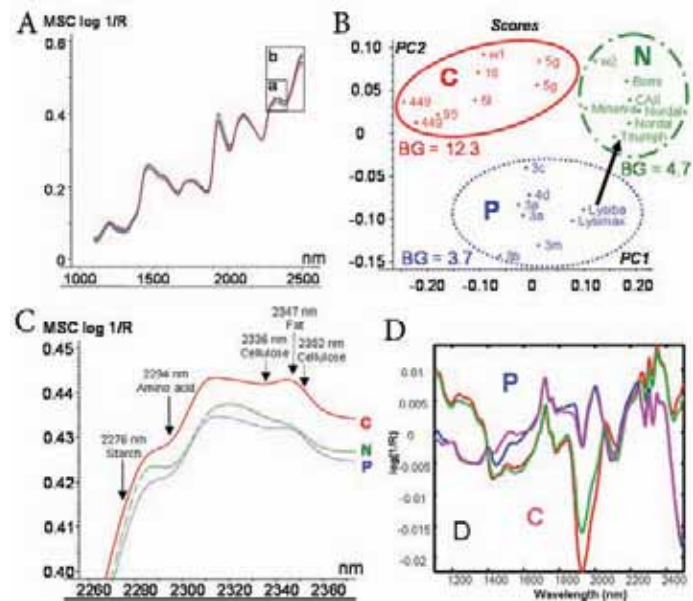

Figure 1 Classification of mutant material ($n=23$) by Principal component analysis (PCA) of Near Infrared Reflectance (NIR) spectra, and by chemical analysis (Munck 2005 [11]). **(A)** Barley seed NIR spectra 400-2500. **(B)** A PCA scoreplot of an endosperm mutant material. Note pos. of *lys3.a* versus *lys3.a* recombinants Lysimax/Lysiba. **(C)** Mean spectra 2260-2360nm for normal (N) barley and protein (P), carbohydrate mutants (C) in B. **(D)** Representation of pleiotropy; mean centered differential MSC *log 1/R* spectra 1100-2500nm to parent line Bomi for the P mutants *lys3.a* (blue), *lys4.d* (magenta) compared to the C mutants *lys5.f* (green) and Risø mutant 16 (red).

The precision of NIRS allows visualization of individual barley mutant gene expression by the differential, subtracted spectral patterns to their parent variety. This is demonstrated by the four differential spectra MSC *log 1/R* 1100-2500nm in **Fig. 1D** with the chemical evaluation shown in **Table 1**. They represent the P mutant's *lys3.a*, and *lys4.d* as well as the C mutant *lys5.f* and Risø mutant 16, all in Bomi grown in greenhouse. It is clearly seen that the two pairs of C and P mutants are differentiated and finely tuned. The seemingly small differences between the members of each pair is highly reproducible when the material is grown in a controlled environment and can be further analyzed by chemometrics and spectral evaluation to be interpreted by chemical analyses (**Table 1**) for verification. The question is now if the NIR selection screening method can be used in plant breeding also involving minor genes? In **Fig. 1B** and in IAEA-CN-167-301 it is demonstrated that the spectral tool can be used in practical "data breeding" from a PCA score plot to select for improved recombinants. The positions of the original mutant *lys3.a* in **Fig. 1B** are moved to the right for Lysimax and Lysiba demonstrating an improved background to the *lys3.a* gene for seed plumpness and for improved starch [4]. The differential spectra 2260 to 2460nm (area a.

Fig. 1A) to Bomi of the improved Lysiba and Lysimax genotypes and of the original *lys3.a* mutant and its *lys3.c* allele in Bomi are presented in Fig. 2A. The spectral differences between the alleles *lys3.a* and *lys3.c* at 2460nm are mainly due to β -glucan (3.1 and 6.4% respectively). The mean starch content of the two *lys3.a* recombinants Lysimax and Lysiba was improved by 4.9 absolute percent in relation to the *lys3.a* genotype when grown in the same field. The spectra from the two starch-improved *lys3.a* lines are moved downwards to the baseline and the characteristic mutant pattern is flattened out approaching Bomi representing a straight line representing 16 years of plant breeding at Carlsberg 1976-90.

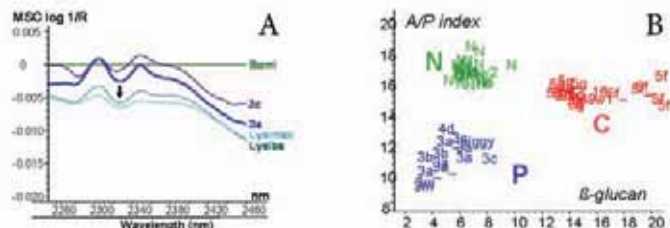

Figure 2 (A) Differential spectra 2260-2480nm to Bomi for the isogenic *lys3.a* and *lys3.c* mutants compared to the starch improved *lys3.a* recombinants Lysimax and Lysiba. (B) Chemical classification of the 69 barley lines by β -glucan versus the Amid/protein A/P index [11].

It was also surprising to us that it was possible to collapse the 1400 NIR spectral points into three chemical analyses β -glucan (x) and the amide/protein A/P index (y) in a x-y plot to obtain just as good a separation of the N, C and P barley genotype classes in Fig. 2B [11] as in the PCA score plot in Fig. 1B. While protein alone has a low power in discriminating between the genotypes, the amide-to-protein (A/P) index clearly separates the high-lysine P mutant *lys3.a* from the others. Ratios seem more indicative for genotype classification than pure variables. This was first demonstrated by the dye-binding (DBC) to Protein (N) plot [1,11] that was used to select the first high lysine mutant Hiproly at Svalöf and that was employed in large scale at Risø [3] to find a collection of mutants. We will hereafter discuss how the new insight in pleiotropy by NIR spectroscopy explains why it is possible to detect mutants with a very complex gene expression by just simple linear plots and ratios [11,12,14].

The barley endosperm mutant NIR-spectral seed model as a tool for a reformed integrated view on the pleiotropic expression of qualitative and quantitative genes.

In genetics there has traditionally been a differentiation between major genes for qualitative and minor “polygenes” for quantitative traits, coupled to an incomplete understanding of pleiotropy. Now our results from NIR spectroscopy of seeds from barley endosperm mutants makes it clear that all active genes are both contributing to and dependent on the internal “genotypic milieu,” as already forecasted by Chetverikov in 1926 [15]. The qualitative morphological seed trait of the *lys3.a* mutant can be described as shrunken seeds with an enlarged scutellar plate (K) in Fig. 3A, and a drastically changed microstructure of the protein bodies of the endosperm in Fig. 3B [6]. Odd Arne Olsen and his group in the 1980-90’ s at the Agricultural University, Ås, Norway, pioneered research in understanding the pleiotropic histological effects in the seed tissues [16] of the different mutants selected as high lysine by the dye-binding to protein (N) method. Both DNA-regulative P protein mutants such as *lys3.a* and DNA-structural C starch mutants such as Risø mutant 16 showed pleiotropic effects involving the diploid (embryo/scutellum) and triploid (aleurone and starchy endosperm) tissues of the seed. In scutellum, both mutant types displayed larger cells than Bomi and had starch granules in the embryo that were absent in the control. In the endosperm, all high lysine mutants except *lys1*. and mutant 7 had smaller cells. An influence of gibberellic acid stimulation was found to be pleiotropic to the *lys3.a*

gene, that was suggested to be in a state of “premature” germination. The Risø mutant 16 and the *lys3.a* genes are indeed “major” genes that involve cell structure and have drastic effects on the chemical composition (Table 1). However, also not so drastic “minor” biochemically specific mutants seem to have a secondary effect on the microstructure of tissues. Thus, the proanthocyanidine “biochemical” mutants of barley developed at Carlsberg in the 1980-90’ s by Diter von Wettstein and Barbro Strid are devoid of the testa layer from the inner seed coating [5]. In order to relate the morphological qualitative traits of the Risø mutant 1508 in Fig. 3A and B to quantitative chemical traits (Table 1) by spectroscopy, the gene specific MSC *log1/R* NIR spectra 1700-1800nm for seeds grown in the field for the *lys3.a* mutant and its parent variety are displayed in Fig. 3C. The two spectra of the *lys3.a* mutant demonstrate a high reproducibility. They deviate in spectral pattern from that of Bomi. The peaks at 1724 and 1762 nm for *lys3.a* are assigned by experiments in the spectroscopic literature to represent unsaturated fat that is increased from 1.7% in Bomi to 3.5% in *lys3.a* (Table 1). To demonstrate that NIR spectra represent patterns of chemical variables or bonds, the NIR wavelengths in the interval MSC *log1/R* 1680-1810nm of the barley material (n=92) [11,12,13,14] were correlated to starch, β -glucan, protein and amid nitrogen. The correlation coefficients are presented in Fig. 3D to explain the chemical significance of the mutant spectra in Fig. 3C. The chemical bonds assigned to specific wavelengths found in literature are presented below in Fig. 3D. It is verified that the chemical correlation spectra obtained by simple correlations in Fig. 3D are finely differentiated and tuned with highly significant positive and negative correlation peaks. Dividing the material in two separate datasets confirmed a high level of reproducibility and fine-tuning. It is characteristic that chemical spectra built on multivariate iPLS correlation coefficients, computed on the same data material with intervals as short as 5nm, is too destructive and cannot obtain a fine tuning comparable to the single wavelength correlation coefficients of the chemical spectra in Fig. 3D. Gentle data treatment to reduce physical scattering in spectra (e.g. MSC), followed by spectral inspection in the tradition of the classical spectroscopist Karl Norris [12,14], is therefore absolutely necessary to avoid losing information. However, data compression by chemometrics is essential for classification (Fig. 1B) and to isolate the “hot spots” in data.

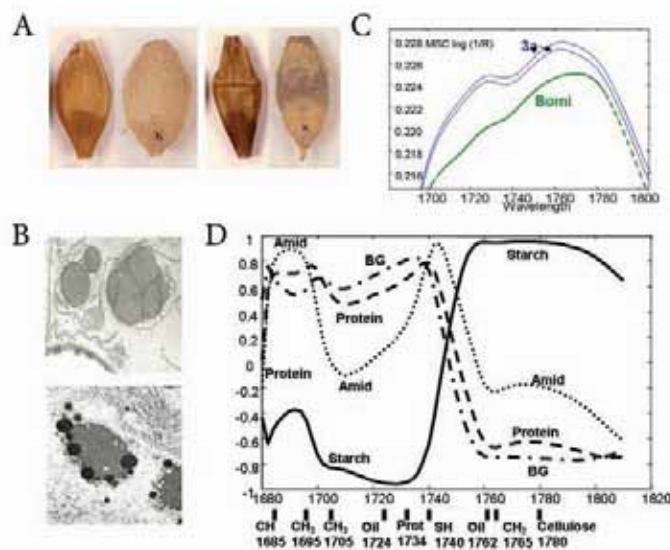

Figure 3 The morphological, microstructural, spectroscopic and chemical interpretation of the *lys3.a* and Bomi phenotypes. (A) Covered and dehulled kernels of Bomi/left and *lys3.a*/right. K= scutellar plate. (B) Electron micrographs of Bomi/above and *lys3.a*/below endosperm protein bodies (Munck and v.Wettstein 1974). (C) MSC *log1/R* NIR spectra 1700-1800nm of Bomi and *lys3.a*. (D) Chemical interpretation of the NIR interval 1680-1820nm by simple correlations for each wavelength.

Fig. 3D represents the richness in chemical information in just a small region of the NIR spectrum. Now, for the first time, NIR spectral representations for the pleiotropy of a mutant gene and for the seed phenome can visualize the concerted action of all genes expressed in “the genotypic milieu” as pleiotropy in Chetverikov’s sense. Bossinger, et al [17], in their paper on the genetics of plant development at the IGBS-VI symposium in Helsingborg, Sweden in 1991, analyzed the classical Svalöf mutant material developed by Åke Gustafsson and Udda Lundqvist. By different morphological classes of mutants, they demonstrated that phytomeric morphological units stepwise regulate plant development. We may here look upon the endosperm tissue in each seed as a self-organizing cellular computer [11,14] that is integrating and adding to the information brought to the seed in the form of assimilate. It reflects the specific phytomeric development from seedling stage to plant maturity. The stunning reproducibility of the spectra from identical genotypes grown under the same conditions [12,14] shows that gene pleiotropy for both plant and seed development mutants can be studied with respect to their effect on seed composition in an isogenic background by NIR spectroscopy.

Table 1. Chemical composition in Greenhouse for BG, Starch (S) BG+S, Protein, Amid, Fat, Lysine and Glutamic acid (Glu)

	n	Betaglucan	Starch	BG+S	Protein	Amide	Fat	Lysine	Glu
Bomi	2	7.0±0.3	47.0±2.6	54.0±2.3	15.7±1.6	0.38	1.7 ^a	3.27 ^a	22.9 ^a
lys3a	2	4.5±1.2	40.7±1.3	45.2±0.1	17.70.9 ^b	0.320.03 ^b	3.5 ^a	4.94 ^a	14.86 ^a
lys4d	1	4.0	41.1	45.1	17.5	0.37	-	4.04	19.46
lys5f	2	19.8±0.2 ^b	30.0±0.78	49.9±0.9	17.0±1.4 ^b	0.42±0.06 ^b	3.7 ^a	3.32 ^a	27.59 ^a
mutant 16	2	15.2±0	29.9 ^a	46.1 ^a	17.1±1.5	0.45±0.06	-	3.37 ^a	22.5 ^a
lys5g	5	13.2±0.7	39.0±8.1 ^c	52.4±8.2 ^c	17.8±1.2	0.44±0.04	2.1 ^a	3.60±0.23 ^c	21.56±1.10 ^c

^an=1, ^bn=3, ^cn=2

The classical genetic notion of considering separate minor polygenes and “heritability” for quantitative traits cut out from the biological network by destructive chemical analyses produces a need for a great number of genes with specific chemical expression. The combined microscopic and spectroscopic analysis in **Fig. 3** suggests that all specific genes and gene mutations have both qualitative and quantitative effects. They produce qualitative pleiotropic phenomenological patterns that can be observed as more or less severe changes in the macro and microstructure of the plant and seed phenotypes. Behind are quantitative chemical changes that by spectroscopy and chemometrics can be transferred back to visualize the hidden gene specific, qualitative chemical patterns that earlier have not been considered in genetics. They can now be compared to the morphological ones and interpreted by molecular methods for classification. In fact, one major gene for a qualitative trait is able to act as several apparent minor polygenes for different quantitative variables. This explains the reduced need from the previously expected several hundred of thousands of specific genes and gene modifiers down to the order of about 30,000 genes that are now sequenced in barley.

In conclusion, in the future, micro-spectroscopy and spectral imaging analysis combined with the new directed mutant techniques for TILLING (Targeted Induced Local Lesions IN Genomes), also presented in this volume, will represent a new promising combination of analytical hardware. This model, applied in a controlled gene background, represents new possibilities to explore and with a great reproducibility, to define a pleiotropic spectral qualitative gene expression for each mutant gene on the level of the phenotype (spectral phenome). The coarsely grained spectral information will be chemically and molecularly quantified and validated by new integrated computerized methods for spectral pretreatment and spectral inspection and with improved data modeling software.

ACKNOWLEDGEMENTS

We thank the IAEA/FAO office in Vienna and its staff that has contributed so successfully in supporting seed mutant research by many inspiring symposia since 1968, Frans van den Berg and Lars Nørgaard for assisting us in writing this article, and Udda Lundqvist for correcting it. We are especially grateful to Professor Harald Martens, Matforsk and CIGENE, Ås Norway, who initiated our group by introducing to us pattern recognition data analysis by chemometrics that is essential in modeling gene expression. Finally, our grateful thoughts go to all those in the past who have assisted in collecting a unique barley mutant collection ideal for basic research in genetics.

BIBLIOGRAPHY

- Munck, L., Karlsson, K.E., Hagberg, A., Eggum, B.O. Gene for improved nutritional value in barley seed proteins. *Science* **168**, 985 (1970).
- Munck, L. Improvement of nutritional value in cereals. *Hereditas* **72**, 1 (1972).
- Doll, H. Barley seed proteins and possibilities for improvement. In: *Cereal Seed Proteins, Advances in Agricultural Biotechnology*. 1. Grain Breeding, (Gottschalk, Werner, Ed.) Martinus Nijhoff/Dr W.Junk Publ., The Hague, 207-223 (1983).
- Bang-Olsen, K, Stilling, B., Munck, L. The feasibility of high-lysine barley breeding-a summary. In: *Barley Genetics IGBS VI*, Helsingborg, Sweden, 1991, (Munck, L., ED.) Vol. 1. Munksgaard International Publ., Copenhagen, 433-438 (1991).
- Von Wettstein, D. The future of barley as an experimental organism. In: *Barley Genetics IGBS VI*, Helsingborg, Sweden, 1991, (Munck, L., ED.) Vol. 2. Munksgaard International Publ., Copenhagen, 1087-1098 (1992).
- Munck, L., V.Wettstein, D. Effects of genes that change the amino acid composition of barley endosperm. In: *Genetic Improvement of Seed Proteins*, National Academy of Sciences, Washington, D.C., 71-82 (1974).
- Mundy, J., Hejgaard, J., Hansen, A., Hallgren, L, Jorgensen, K.G., Munck, L. Differential synthesis *in vitro* of barley aleurone and starch endosperm proteins. *Plant Physiol.* **81** (1986).
- Leah, R., Tommerup, H., Svendsen, I., Mundy, J. Biochemical and molecular characterization of three barley seed proteins with antifungal properties. *J. Biol.Chem.* **266**, 1564 (1991).
- Rudi, H., Uhlen, A.K., Harstad, O.M., Munck, L. Genetic variability in cereal carbohydrate compositions and potentials for improving nutritional value. *Animal Feed Sci. Techn.* **130**(1-2), 55 (2006).
- Martens, H., Martens, M. Analysis of Quality – an introduction, John Wiley and Sons, Chichester, UK, (2000).
- Munck, L. The revolutionary aspect of chemometric technology – the universe and biological cells as computers. (available from lmu@life.ku.dk), Samfundsliteratur Grafik, The Royal Vet. and Agr. Univ., Frederiksberg, Denmark, (2005).
- Møller Jespersen, B., Munck, L. Cereals and cereal products-from prediction of simple analytes to classification of complex genotypes and functional factors for quality, IR-spectroscopy in Foods, (Da-Wen Sun ED.), Academic Press/ Elsevier, 275-320 (2009).
- Munck, L., Møller, B., Jacobsen, S., Søndergaard, I. Near Infrared Spectra indicate specific mutant endosperm genes and reveal a new mechanism for substituting starch with β -glucan in barley. *J. Cereal.Sci.* **40**, 213 (2004).
- Munck, L. A new holistic approach to systems biology by near infrared spectroscopy evaluated by chemometrics and data inspection, *J. Chemometrics* **21**, 406 (2007).
- Chetverikov, S.S. On certain aspects of the evolutionary process. In Russian 1926. English translation, *Proc. American Phil. Soc.* **105**, 167 (1961).
- Olsen, O.A., Krekling, T., Nissen, Ø., Ayaz, M. An ultrastructural approach to the problem of barley gene action”, Proceedings of the final research coordination meeting in 1982 of the FAO/IAEA/GSF/SIDA research program on Cereal and Grain Legume Seed Protein Improvement, IAEA/STI/PUB 664, 241-257 (1984).
- Bossinger, G., Lundqvist, U., Rohde, W., Salamini, F. Genetics of plant development in barley, *Barley Genetics IGBS VI* (MUNCK, L., ED), Vol. 2, Munksgaard International Publ., Copenhagen, 989-1022 (1992).

The Effect of Plants with Novel Traits (PNT) Regulation on Mutation Breeding in Canada

G G Rowland

Abstract

The Canadian Environmental Protection Act (1988) has within it a definition for biotechnology. This definition would have allowed the government department, Environment Canada, to regulate all genetically modified organisms (GMOs) in Canada. In response to this, the Canadian Food Inspection Agency (CFIA), which reports to the Minister of Agriculture and Agri-Food Canada, developed the concept of a Plant with Novel Trait (PNT). Not only does this definition capture GMOs, it also includes induced mutations, natural mutations and exotic germplasm that have not previously been grown in Canada. It is a system that is product, not process based. However, apart from questions regarding the novelty of traits in new plant varieties, breeders are asked by CFIA to identify the process used to develop the trait or traits in question. Field trials involving breeding lines with a PNT may be subject to confined testing. This conference celebrated 80 years of unconfined development and testing of induced plant mutations. This regulation is time consuming, expensive and an innovation barrier for Canadian plant breeding. It can only be hoped that other nations, and particularly those that have successfully used induced mutations, will not emulate Canada's approach.

Introduction

The announcement for this meeting summarized the use of mutation techniques in plants over the past 80 years and the positive economic impact this has had throughout the world. During the meeting we have learned of the direct release of varieties of crop plants from mutation breeding and varieties developed with genes identified in mutant crop plant populations. We have also heard about the use of site directed mutagenesis, which would avoid the regulatory hurdles associated in most countries with genetically modified organisms (GMOs). We were told that TILLING (Targeted Induced Local Lesions IN Genomics) would also not be caught in the regulatory trap. However, this use of mutations does not avoid regulation in Canada. How Canada came to be in this position and the regulation's effect on plant breeding is the subject of this presentation.

CEPA

In 1988 the Parliament of Canada passed the Canadian Environmental Protection Act (CEPA) into law. Within this Act is a definition for biotechnology, which reads: *the application of science and engineering in the direct or indirect use of living organisms or parts or products of living organisms in their natural or modified forms.* The definition was placed in CEPA to deal with concerns regarding genetically modified organisms (GMOs) and allow Environment Canada to regulate all GMOs as well as varieties arising from traditional plant breeding techniques. It is interesting that biotechnology is the only technology defined in CEPA,

and this reveals the shaky ground on which the definition was built and its spurious danger to the environment.

CFIA response to CEPA

Government departments do not like to have responsibilities taken from them and, in this case, the danger that it poses is towards production agriculture in Canada. From 1988 and onwards, Environment Canada had the potential to regulate the registration of crop varieties in Canada, a responsibility that was then held by a branch of Agriculture Canada. In anticipation of the regulatory issues CEPA would cause, Agriculture Canada and the Ministry of State for Science and Technology sponsored a Workshop on the Regulation of Agricultural Technology organized by the Canadian Agriculture Research Council (CARC). CARC was a council of agriculture researchers from industry, universities and federal and provincial governments and they invited a number of respected Canadian scientists to the workshop. The workshop developed 18 recommendations that were sent to various government ministries including Agriculture Canada. The two key recommendations that applied to crops were:

- *The products of biotechnology should be regulated, not the process that produces them and*
- *The definition of biotechnology in use by the regulatory agencies is too broad and must be redefined with more focus. The plant sector, for example, would limit it to genetic engineering.*

By 1997 the responsibility for registering crop varieties had passed on to a reorganized group of Agriculture Canada known as the Canadian Food Inspection Agency (CFIA). The CFIA has organized a number of workshops over the years to explain the regulation of GMO's in Canada, one of which took place at the University of Saskatchewan in 2004. An official of the CFIA in his presentation stated:

1. *The CARC workshop arrived at several key recommendations*
2. *The product, not the process should be regulated. Those plants which possess characteristics or traits sufficiently different from the same or similar species should require an assessment of risk.* (<http://www.inspection.gc.ca/english/plaveg/bio/consult/novnou/watsone.shtml>)

However, as regards point 2, the CARC meeting actually recommended:

Products Subject to Regulation:

“Genetically modified organisms (GMO), which possess characteristics or traits that are ‘sufficiently different’ from the characteristics or traits of previous members of the same or similar species so as to require a separate assessment of risk”

Definitions for the above

Genetically modified organisms: organisms which are obtained by in vitro alteration of genetic material including, but not restricted to, recombinant DNA, nuclear and organelle transplantation, or genetic manipulation of viruses.

Crop Development Centre, Department of Plant Sciences, College of Agriculture and Bioresources, University of Saskatchewan, Saskatoon, Saskatchewan, Canada

E-mail: gordon.rowland@usask.ca

Despite the best advice of CARC and members of the Canadian Plant breeding community, in 1994 Agriculture Canada issued regulatory directive 94-08, which contained the following concept and definition:

Plant with Novel Trait: A plant variety possessing a characteristic that is intentionally selected or created through a specific genetic change and is either not previously associated with a distinct and stable population of the cultivated plant species in Canada or expressed outside the normal range of a similar existing characteristic in the plant species.

So what exactly is a plant with a novel trait (PNT) in Canada? CFIA defines it as:

A PNT is a plant that contains a trait that is both new to the Canadian environment and has the potential to affect the specific use and safety of the plant with respect to the environment and human health. These traits can be introduced using biotechnology, mutagenesis, or conventional breeding techniques and have some potential to impact weediness, gene flow, plant pest potential, non-target organisms, or biodiversity. (<http://www.inspection.gc.ca/english/plaveg/bio/pbobbve.shtml>)

Canada now has a system that not only regulates GMOs but also is able to regulate traditional breeding techniques as well as induced mutation! This, despite there being no evidence that induced plant mutations have caused harm to humans, animals or the environment. We are told that Canada's variety registration system is science based but there was no review of the science of mutation breeding in the development of the PNT definition. Despite assurances from CFIA and the recommendation of CARC, we do not have a product based regulatory system. We now have a system in which both product (novelty) and process (GMO) is regulated. In the Procedures for the Registration of Crop Varieties in Canada published by the CFIA the pedigree of the proposed variety is required such that:

In the case of varieties resulting from recombinant gene technology, information on the gene(s) inserted, its source and gene products must be provided. Exact DNA sequence information must be provided to facilitate the generation of gene probes for variety verification purposes. <http://www.inspection.gc.ca/english/plaveg/variet/proced/regproe.shtml>

In the Variety Registration Application Form, the developer is specifically asked: does this variety contain traits that are novel to its species?, is referred back to Regulatory Directive 94-08.

Examples of the effect of PNT regulation

The "Flor de Mayo" bean is a particular market class of *Phaseolus vulgaris* L. that has a pink, marbled seed coat color and is not unlike the pinto or cranberry classes grown in Canada. It is a popular market class in Mexico, which has export potential for Canada. However, there is no variety of "Flor de Mayo" bean registered for production in Canada. The Crop Development Center (CDC) at the University of Saskatchewan developed a variety of "Flor de Mayo" and applied for a Canadian registration of the variety in April of 2002. After considering the application, the CFIA asked the CDC to prove that it wasn't a PNT since this "type" had never been grown in Canada. Since the market potential for Saskatchewan grown "Flor de Mayo" beans was judged to be too small, the CDC determined that the costs associated with demonstrating the "safety" of this market class were not worth it. Consequently, the application to register the variety was withdrawn.

The experience of the CDC in the registration of the low phytate barley, HB379, is an example of other difficulties that the PNT definition has produced. The low phytate character is one that was often referred to at this conference, as it is an example of mutant genes being used for improving the nutritional and environmental quality of some crop plants. The CDC had developed a low phytate barley, HB379, and applied to CFIA for registration in May 2006. There was no indication from CFIA that this was a PNT but there was a concern that it was a "novel feed." The concept of a novel feed was one that arose out of the

novel plant concept and is administered by the CFIA. It took 17 months and hundreds of man-hours before HB379 was finally registered for production in Canada.

Conclusion

The concept of PNTs as developed and applied in Canada is time-consuming, expensive and an innovation barrier for Canadian plant breeding. It is a threat to the constructive use of plant mutations for crop improvement and it is to be hoped that other countries will not follow Canada's example.

BIBLIOGRAPHY

1. CANADIAN AGRICULTURAL RESEARCH COUNCIL, Proceedings of a Workshop Regulation of Agricultural Products of Biotechnology. Ottawa, Canada (1988).

Turning Plant Mutation Breeding Into a New Era: Molecular Mutation Breeding

Q Y Shu

Abstract

Advances in molecular genetics and DNA technologies have brought plant breeding, including mutation breeding, into a molecular era. With ever-increasing knowledge of molecular genetics and genomics and rapidly emerging molecular techniques, breeders can now use mutation techniques in breeding new varieties more wisely and efficiently than ever before. Plant molecular mutation breeding is here defined as mutation breeding, in which molecular or genomic information and tools are used in the development of breeding strategies, screening, selection and verification of induced mutants, and in the utilization of mutated genes in the breeding process. It is built upon the science of DNA damage, repair and mutagenesis, plant molecular genetics and genomics of important agronomic traits as well as induced mutations. Mutagenic treatment, super-mutable genetic lines, molecular markers and high throughput DNA technologies for mutation screening such as TILLING (Targeting Induced Limited Lesions IN Genomes), are the key techniques and resources in molecular mutation breeding. Molecular mutation breeding will significantly increase both the efficiency and efficacy of mutation techniques in crop breeding. A perspective molecular mutation breeding scheme is proposed for discussion.

Introduction

Plant breeding is often regarded as applied genetics, and so is mutation breeding. One of the most important breakthroughs in the history of genetics was the discovery of experimental mutagenesis in the early 20th century, which later brought about plant mutation breeding. Without knowing much of the molecular biological basis, a vast amount of genetic variability was induced in the most economically important plant species, and a small portion of those variations induced has resulted in the development of more than 3,000 mutant varieties worldwide in about 180 plant species during the past 60 years [1]. With the unprecedented development of plant molecular genetics and functional genomics during the past decade, scientific exploration of induced mutation in plants has progressed dramatically from basic research on mutagenesis in plants, to the development of advanced genomics-based technologies, to their unique applications in gene discovery and development of novel crop traits [2]. These developments are bringing plant mutation breeding into a new paradigm – Plant Molecular Mutation Breeding.

Genetics and features of classical mutation breeding

In principle, plant breeding methods can be classified into three systems: recombination breeding, mutation breeding and transgenic breeding, each with unique way of generating variation and of selecting target lines (Table 1). In terms of mutation breeding, the generation of new mutated alleles is the core and most unique feature. The genetics behind mutation breeding includes differences in the sensitivity of different

genotypes and plant tissues to different mutagens, often measured using lethal doses (LD), genetic chimeras after mutagenic treatment and their effect on transmission of mutated alleles and segregation in the following generation, and also the often recessive nature of induced mutations. Such knowledge of genetics is important for establishing proper doses and modes of mutagenic treatment, as well as for the methodology of harvesting and growing M_2 populations (Table 1).

Mutation breeding has its advantages and limitations. The advantages include creation of new gene alleles that do not exist in germplasm pools, and the induction of new gene alleles for a commercial variety so new varieties carrying desired mutation alleles can be directly used as a commercial variety. The limited genetic changes of any single plant of a mutated population and the often recessive nature, enable breeders to develop a new variety in a short breeding cycle. The disadvantage of mutation breeding is its limited power in generating the dominant alleles that might be desired; it is also less effective than cross breeding for a trait needs for a combination of multiple alleles, such as tolerance to abiotic stresses. The low mutation frequency requires growing and screening a large population for selection of desired mutants at a reasonable confidence. This becomes very expensive for traits that have to be evaluated through laborious phenotypic analysis.

Table 1. Genetics of three unique breeding methods for seed crops

	Recombinant breeding	Mutation breeding	Transgenic breeding
Source of genetic variation	Recombination of gene alleles from parental varieties.	New alleles artificially and randomly created from endogenous genes.	Insertion of new genes or modification of endogenous genes.
Transmission, expression and inheritance	No selective transmission; co-segregation of closely linked alleles.	Induced mutations subject to diploptic and haploptic selection.	Expression of transgenes subject to position effect or silencing.
Nature of gene action	Dominant, recessive alleles, and QTLs.	Mostly recessive alleles.	Mostly dominant alleles.
Breeding generations*	About 10 generations.	About 2-3 generations.	About 3 generations.

* the number of generations needed to obtain a homozygous line

Molecular genetics and genomics related to mutation breeding

The rapid development of plant molecular genetics and genomics in areas relevant to mutation breeding has been reinvigorating this breeding method; it is expected that mutation breeding will directly benefit from the rapid scientific and technological advances in molecular genetics and genomics.

DNA damage and repair

It has been well documented that DNA is subject to continuous damage and the cell has an arsenal of ways of responding to such injury; although mutations or deficiencies in repair can have catastrophic consequences

Joint FAO/IAEA Division of Nuclear Techniques in Food and Agriculture, International Atomic Energy Agency, Wagramer Strasse 5, P.O. Box 100, A-1400 Vienna, Austria.

E-mail: q.y.shu@iaea.org

for organisms, mutations are nonetheless fundamental to life and evolution [3]. With the accumulating knowledge of the molecular genetics of DNA damage and repair, we can now elucidate many of the phenomena that we have observed in classical mutagenesis, e.g. the differences of sensitivity to different mutagens among plant species and among plant materials. There are different pathways for the repair of DNA damages caused by different types of mutagen, for example, gamma irradiation often leads to DNA double strand breaks (DSBs, [4]), ultraviolet (UV) radiation results in covalent dimerization of adjacent pyrimidines [3], while chemical mutagens cause miss-pairing or nucleotide excision. This knowledge is very important for properly designing mutagenic experiments in a way that an enhanced mutation frequency can be achieved. For example, there are two pathways in DSB repair: homologous recombination (HR) and non-homologous end-joining (NHEJ); also known as illegitimate recombination). HR repair is quite precise and results in few mutations, while NHEJ is an error-prone process and thus can produce mutations [4]. Therefore, a genetic line defective in HR repair, or haploid materials such as pollen or anther (lack of homozygous DNA template for HR) is expected to produce a high frequency of mutations after radiation treatment. Such knowledge may also provide clues to identify new chemicals that can induce mutations in plants while having limited toxicity to humans.

Molecular genetics of induced mutations

Cells with damaged DNA will survive only when these damages are repaired either correctly or erroneously; the result of erroneous repairs will be fixed in the genome as induced mutations. The nature of DNA damage caused by different types of mutagens to a great extent determines the molecular feature of induced mutations. For example, the chemical mutagen EMS often leads to mutations of G/C to A/T transition [5], while ion beam implantation could cause deletion of DNA fragments of various sizes [6]. Although information is so far limited in this field, such knowledge will definitely help choose the proper mutagen for different purposes in mutation breeding. For example, DNA deletions in most cases will cause recessive mutations, while nucleotide substitution may produce a dominant allele. Therefore, when a recessive mutation could solve the problem, irradiation might be a better choice, while when a dominant mutation is needed (for example for herbicide resistance), a chemical mutagen might be more useful. It is also important for establishing proper methods of DNA-based mutation screening.

Molecular genetics of target trait

In general, plant molecular breeding depends on the understanding of the molecular genetic control of target traits of interest. Molecular genetic information is also of great help in developing a proper mutation breeding strategy. First, it is important for assessing the feasibility and potential to induce a mutation of interest. Since the mutation frequency for any given fragment of DNA or gene is more or less similar, the opportunity to obtain a mutant of different traits would therefore be dependent on the number of genes that control the trait. For example, many genes can affect the growth duration (i.e. days from sowing to heading for cereals), therefore the mutation frequency of such trait is often far higher than single-gene controlled traits [7]. Second, a mutation may have pleiotropic effects if the gene is at the upstream or at the middle of a long biosynthetic pathway, such as the MIPS gene in phytic acid biosynthesis and precautions should be taken for such a mutation project. Third, knowledge of genes controlling a trait of interest would constitute the very basis of the TILLING (Targeting Induced Limited Lesions IN Genomes) method.

Perspective of molecular mutation breeding

With more knowledge of DNA damage, repair and mutagenesis becoming available, more traits of interest being dissected at the molecular genetics level, and more molecular techniques developed and com-

manded by breeders, mutation breeding will be transformed into a new paradigm. A perspective scheme is proposed with the potential to significantly enhance the efficiency of plant mutation breeding (Fig. 1).

Effective mutation induction

Mutation induction is the starting step in mutation breeding, and its low frequency has been a severe limiting factor. Equipped with knowledge of the DNA damage and repair, we should be able to design strategies of mutagenic treatment to significantly increase the mutation frequency. For example, smartly combined use of chemical and physical mutagens, and recurrent mutagenic treatments, would increase mutation frequency, since theoretically each time of treatment would cause DNA damage which should be repaired after treatment, and consequently introduce new mutations each time. We should be able to select a suitable mutagen and starting material for a specific purpose, for example, chemical mutagens should be more suitable for inducing dominant alleles while physical mutagens might be better used for recessive mutations.

When the genes responsible for correct DNA damage repair are knocked out or mutated, these lines could become highly sensitive to mutagenic treatment and mutation frequency could be significantly increased. Such lines are commonly called “super mutable genetic lines”, they could be generated through genetic transformation, i.e. silencing the genes using RNAi technology (Fig. 1). Once mutants of important traits are induced and identified using such super mutable lines, the transgenes and mutated genes can be separated by self-crossing since they are not linked to each other, hence non-transgenic stable mutant lines could be produced (Fig. 1). This has already been proven in *Arabidopsis* by silencing the mismatch repair gene AtMSH2 [8]. Similarly, suppression of the HR system through a transgenic or classic mutation approach is expected to enhance the NHEJ repair, and hence induce mutations at a higher frequency when treated with physical mutagens that could cause DSBs.

We should also be able to produce super mutable plant lines by genetic modification of specific genes in DNA repair system as shown [8]. Similarly, suppression of the HR system could enhance the NHEJ repair and hence induce a higher mutation frequency when treated with physical radiations.

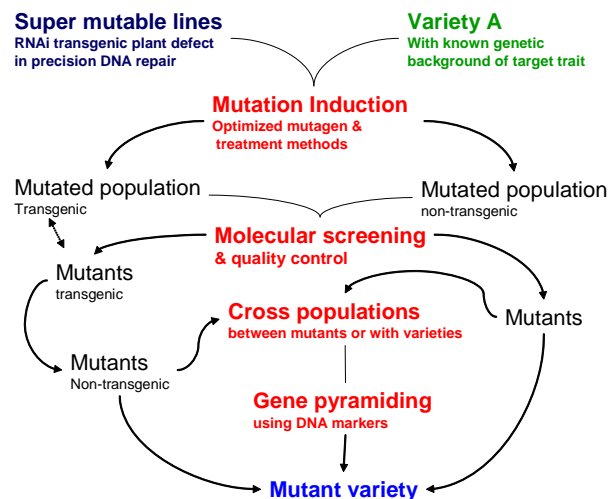

Figure 1 Plant molecular mutation breeding scheme.

High throughput mutation screening

Mutation screening has been another bottleneck in mutation breeding, particularly for traits that cannot be visually identified and have to be

assessed by costly or laborious chemical tests. This is being changed due to the establishment of DNA-based mutation screening techniques during the past few years [2].

The TILLING system [9], for example, based on the CEL I cleavage of mismatches, has been successfully exploited in several plant species [2]. A variety of modified versions of TILLING have already become available, such as that for detection of deletions --de-TILLING [10]. It is foreseen that mutation screening technology will become more high throughput, powerful and affordable with the rapid development of DNA technologies including high throughput DNA sequencing techniques.

Mutation utilization

In classical mutation breeding, induced mutations are embedded in mutants that are either directly or indirectly (through crosses with other varieties) used for developing a new variety, whereby it is rather difficult to trace the mutated genes in subsequent breeding. It is now possible to tag mutated genes, pyramid them into a single elite breeding line, and follow them up in subsequent breeding programs (Fig. 1).

When the genes responsible for correct DNA damage repair are knocked out or mutated, these lines could become highly sensitive to mutagenic treatment and mutation frequency could be significantly increased. Such lines are commonly called “super mutable genetic lines”, they could be generated through genetic transformation, i.e. silencing the genes using RNAi technology (Fig. 1). Once mutants of important traits are induced and identified using such super mutable lines, the transgenes and mutated genes can be separated by self-crossing since they are not linked to each other, hence non-transgenic stable mutant lines could be produced (Fig. 1). This has already been proven in *Arabidopsis* by silencing the mismatch repair gene AtMSH2 [8]. Similarly, suppression of the HR system through a transgenic or classic mutation approach is expected to enhance the NHEJ repair, and hence induce mutations at a higher frequency when treated with physical mutagens that could cause DSBs.

BIBLIOGRAPHY

1. Shu, Q.Y., Lagoda, P.J.L. Mutation techniques for gene discovery and crop improvement. *Mol Plant Breed.* **5**, 193-195 (2007).
2. Waugh, R., Leader, D.J., McCallum, N., Caldwell, D. Harvesting the potential of induced biological diversity. *Trends in Plant Sci.* **11**, 71-79 (2006).
3. Friedberg, E.C. DNA damage and repair. *Nature* **421**, 436-440 (2003).
4. Puchta H. The repair of double-strand breaks in plants: mechanisms and consequences for genome evolution. *J Exp Bot.* **56**, 1–14 (2005).
5. Till B.J., Cooper J., Tai T.T., Caldwell D., Greene E.A., Henikoff S., Comai L. Discovery of chemically induced mutations in rice by TILLING. *BMC Plant Biol.* **7**, 19 (2007).
6. Naito K., Kusaba, M., Shikazono, N., Takano, T., Tanaka, Tanisaka A.T., Nishimura, M. Transmissible and nontransmissible mutations induced by irradiating *Arabidopsis thaliana* pollen with gamma-rays and carbon ions. *Genetics* **169**, 881-889 (2005).
7. Fu, H.W., Li, Y.F., Shu, Q.Y. A revisit of mutation induction by gamma rays in rice: implications of microsatellite markers for quality control. *Mol. Breed.* **22**, 281-288 (2008).
8. Leonard, J.M., Bollman, R., Hays, J.B. Reduction of stability of *Arabidopsis* genomic and transgenic DNA-repeat sequences (microsatellites) by inactivation of AtMSH2 mismatch-repair function. *Plant Physiol.* **133**, 328-338 (2003).
9. Colbert T., Till, B.J., Tompa, R., Reynolds, S., Steine, M.N., Yeung, A.T., McCallum, C.M., Comai, L., Henikoff, S. High-throughput screening for induced point mutations. *Plant Physiol.* **126**, 480-484 (2001).
10. Wang et al.
11. Zhao, H.J., Ren, X.L., Liu, Q.L., Wu, D.X., Shu, Q.Y. Gene identification and allele-specific marker development for two allelic low phytic acid mutations in rice (*Oryza sativa* L.). *Mol Breed.* **22**, 603-612 (2008).
12. Xu, X.H., Zhao, H.J., Liu, Q.L., Frank, T., Engel, K.H., An, G., Shu, Q.Y. Mutations of the multi-drug resistance-associated protein ABC transporter gene 5 result in reduction of phytic acid in rice seeds. *Theor Appl Genet.* **119**, 75-83 (2009).

Molecular Genotyping of GA₃ Insensitive Reduced Height Mutant of Emmer Wheat (*Triticum dicoccum*)

S Sud¹, K A Nayeem² & S G Bhagwat^{1,*}

Abstract

Emmer wheat (*Triticum dicoccum* Schubler) is cultivated in parts of peninsular India. Grains of emmer wheat contain higher amounts of protein and dietary fiber and hence are recommended for inclusion in the diet. Traditional varieties of emmer are tall, susceptible to lodging and low yielding. An induced semi-dwarf mutant was obtained in tall emmer wheat variety NP200. The seeds of variety NP200 were subjected to 100, 200, 300 or 400Gy of γ -rays. In the M₂ population of 200Gy treatment, a reduced height mutant with vigorous growth and high tillering was observed. The reduced height mutant, its parent and other emmer varieties were tested for their response to GA₃ treatment in seedling test. The mutant was found to be insensitive to externally applied GA₃. The mutant, its parent and tall and semi-dwarf varieties of emmer were subjected to *Rht* genotyping. Allele specific primers for dwarfing gene (*RhtB1b*) and their wild type allele (*RhtB1a*) were used. The validity of primers in emmer varieties was confirmed. All semi-dwarf emmer varieties showed a band of 237bp with primer pair BF-MR1. The mutant (HW1095) showed absence of amplification for both *RhtB1a* and *RhtB1b* alleles with respective primer pairs, indicating that the mutant carried a different mutation than the existing allele (*RhtB1b*). The mutant allele was amplified with another primer pair resulting in a product of about 400bp. In a comparative yield trial, the mutant gave higher yield than the other emmer wheat.

Introduction

Emmer wheat (*T. dicoccum*) is reported to contain high amounts of protein and dietary fiber [1,2] and hence is recommended for inclusion in diet [3]. Emmer possesses better resistance to wheat rust and is more tolerant to high temperature than other species of wheat [4,5]. Traditional varieties of emmer are tall, susceptible to lodging and low yielding [6]. Tall emmer variety NP200 is a selection from local wheat. Introduction of semi-dwarf stature has resulted in improvement in harvest index and yield in bread wheat. To date, 21 height reduction genes are known in wheat, including two major genes *RhtB1b* and *RhtD1b* which are present in 90% of the semi-dwarf cultivars [7]. Search for alternative height reducing genes led to the discovery of genes *RhtB1d* and *Rht8* (located on 2DS) from varieties Saitama-27 and Akakomughi respectively. Introduction of dwarfing gene *RhtB1b* has also shown improvement in emmer wheat [8]. It seems possible to generate variability for reduced height genes to increase options for breeders to improve emmer wheat. In this study, investigations on a γ -ray induced short stature mutant HW1095 are reported.

Materials and Methods

Seeds of emmer wheat variety NP200 were subjected to 100, 200, 300 and 400Gy of γ -rays. Treated seeds were space planted in the M₁ genera-

tion, allowed to self-pollinate and were harvested individually. In the M₂ population of 200Gy treatment, a reduced height mutant with vigorous growth and high tillering was observed, and carried forward as plant to row progeny. Subsequently, its progeny was designated HW1095. The mutant was tested in yield trials in five states representing peninsular and central parts of India.

GA₃ insensitivity test

Twenty seeds were placed in blotting paper folds supported by stands. Seedlings were grown either in water (control) or 10⁻⁴M GA₃, their height was recorded after 12 days, and differences in seedling height of GA₃ treated and control plants were analyzed using Student's t-test.

Rht genotyping

DNA was isolated from bulk of five plants according to [9]. The mutant along with parent (NP200), tall variety (NP201) and semi-dwarf emmer varieties (DDK1009, DDK1025, HW5013, HW5301 and MACS2961) were subjected to *Rht* genotyping. The alleles *RhtB1b* and *RhtB1a* were amplified using allele specific primer combinations: primer BF: (5'-GGTAGGGAGGCGAGAGGCGAG-3') and MR1: (5'-CATCCCCATGGCCATCTCGAGCTA-3') for *RhtB1b*; primers BF and WR1 (5'-CATCCCCATGGCCATCTCGAGCTG-3') for *RhtB1a* [10]. DNA from the mutant along with tall and semi-dwarf emmer varieties was also amplified with a different primer pair, which differs from perfect pair at forward end (5'-TCTCCTCCCTCCCCACCCCAAC-3'). The PCR reaction was performed in 25 μ l containing 10pmoles of each primer, 100 μ M of dNTPs, and 2mM of MgCl₂, 1 unit of *Taq* DNA polymerase and 100ng of template DNA in an Eppendorf Mastercycler. The PCR products were separated on a 2% agarose gel prepared in 1X TBE buffer, visualized under UV light after Ethidium bromide staining and photographed [11].

Results and Discussion

The mean height of parent was 110cm, the mutant was about 35% shorter at mean of 71cm. There was no major segregation in the mutant for height in subsequent generations. In general, the mutant resembled the parent in morphology and was about three days early in flowering. In addition, the mutant showed reduced lodging.

The reduced height mutant along with its parent and other emmer varieties were tested for their response to externally applied GA₃. Height of control (water grown) seedlings of parent was 25.4 \pm 0.6cm while GA₃ treated seedlings were 35.9 \pm 1.4cm. There was 29.2% (p \le 0.01) increase, which was significant (p \le 0.01). Difference in seedling height of control (water grown) (18.80.4cm) and GA₃ treated (19.2 \pm 0.5cm) for the mutant was not significant. This showed that the mutant was insensitive to GA₃ treatment. The mutant seedlings were 45.6% lower in height as compared to the parent after GA₃ treatment. Another tall emmer variety NP201, showed 24.2 \pm 0.3 and 30.4 \pm 0.6cm for control and treatment, respectively. The difference (20.4%) (p \le 0.01) was significant. The corresponding values for the semi-dwarf emmer varieties DDK1009, DDK1025,

¹ Nuclear Agriculture and Biotechnology Division, Bhabha Atomic Research Centre, Trombay, Mumbai-400 085, India.

² Indian Agricultural Research Institute, Regional Station, Wellington-643231, The Nilgiris, Tamil Nadu, India.

* Corresponding author. E-mail: sood004@yahoo.co.in, sbhagwat@barc.gov.in

HW5013, HW5301 and MACS2961 were 16.8 ± 0.2 , 18.7 ± 0.5 , 17.1 ± 0.3 , 16.6 ± 0.3 and 16.3 ± 0.4 for control, and 16.0 ± 0.2 , 18.4 ± 0.4 , 16.1 ± 0.4 , 14.5 ± 0.3 and 15.2 ± 0.5 for GA₃ treatment, showing no significant difference ($p \leq 0.01$).

Emmer is gaining importance and yield improvement is needed. Reduction in plant height has been found to be effective in improving yield in high input conditions in durum and bread wheat. Transfer or induction of dwarfing genes has been useful in imparting lodging resistance and resulted in improvement of harvest index. Semi-dwarf varieties of emmer wheat have been developed, however, there is scope to induce mutation for this trait.

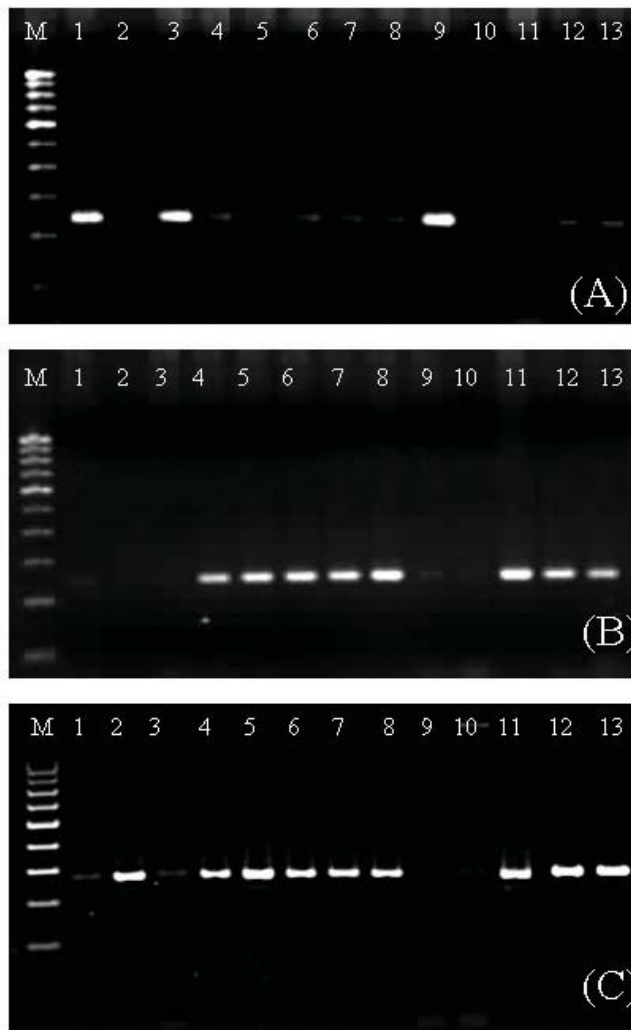

Figure 1 PCR analysis of *T. dicoccum* varieties and *T. dicoccum* (mutant) and *T. durum* varieties. Lane M: 100 bp ladder; Lane 1 & 3: *T. dicoccum* tall varieties-NP200 & NP201; Lane 2: *T. dicoccum* mutant HW1095; Lanes 4-8: *T. dicoccum* dwarf varieties - DDK1009, DDK1025, HW5013, HW5301, MACS2961; Lanes 9 & 10: *T. durum* tall varieties- A-9-30-1 & Bijaga Yellow; Lanes 11-13: *T. durum* dwarf varieties-HD4502, HD4530 and MACS2846: with primer BF-WR1 for RhtB1a (A), BF-MR1 for RhtB1b (B) and new primer pair (5'-CTCCTCCCTCCCAAC-3') and (5'-CATCCCATGGCCATCTCGAGCTA-3') (C).

A reduced height phenotype in the material under investigation can result from introgression of the known gene *RhtB1b* or from an induced mutation. To check these possibilities, allele specific markers for *RhtB1b* developed according to [10] were used. The semi-dwarf durums (HD4502, HD4530, and MACS2846) showed amplification of *RhtB1b* (Fig.1, B). Allele specific markers were also used to check the status in tall emmer (NP200 and NP201), five semi-dwarf emmer varieties (DDK1009, DDK1025, HW5013, HW5301 and MACS2961)

and the newly developed semi-dwarf mutant (HW1095) (Fig.1, A & B). Use of allele specific markers has not been reported earlier in emmer wheat. The validity of primers in tall emmer varieties for *RhtB1a* and semi-dwarf emmer varieties for *RhtB1b* was confirmed. All semi-dwarf emmer varieties showed a band of 237bp with primer pair BF-MR1. The parent variety NP200 showed amplification of wild-type allele (*RhtB1a*), however, the mutant (HW1095) showed absence of amplification for both *RhtB1a* and *RhtB1b* alleles with respective primer pairs. This indicated that the mutant carried a different mutation than the existing allele (*RhtB1b*). This was further confirmed by amplifying with another primer pair which covers a longer stretch of DNA segment (Fig. 1C). In the mutant, this primer amplified a product of about 400bp as compared to 237bp with perfect primer pair (BF-MR1). These results are consistent with another study where this primer was reported to amplify the mutant allele which was not amplified by perfect primer pair [13]. The amplification will enable further characterization of induced mutation. A variation was also observed in tall durum cultivar Bijaga Yellow, where a band of 237bp was expected with the primer pair BF-WR1, however, no amplification was observed with either primer pairs (Fig. 1, A & B).

A comparative yield trial, which included eight released varieties of emmer, one bread wheat and one durum as check varieties, NP200 parent and the mutant HW1095, was conducted in five diverse locations [12]. The results showed that the mutant gave highest yield in three of the five locations among all the varieties. The mutant gave higher yield than the parent and other emmer wheat varieties at all the locations (Table 1).

Table 1. Grain yield of reduced height mutant (HW1095), parent and released varieties across different emmer growing regions of India

Genotype	Gujarat State (qt/ha)	Karnataka State (qt/ha)	Maharashtra State (qt/ha)	Tamil Nadu State (qt/ha)	Peninsular Zone (qt/ha)	Mean of All Zones (qt/ha)
DDK1028	22.7	37.8	37.9	22.1	37.6	33.2
DDK1030	23.5	39.7	41.2	07.2	40.3	33.6
DDK1009	23.5	38.5	40.2	29.4	39.2	35.1
MACS-2947	26.8	39.5	40.9	27.2	40.0	36.2
DDK1025	21.7	42.5	39.4	31.8	44.1	36.3
MACS-2956	25.4	40.0	39.6	35.9	39.7	36.6
DDK1029	31.5	41.4	46.5	10.9	43.5	37.9
MACS-2961	26.8	42.7	46.0	23.4	44.1	38.6
NP200 (parent)	22.6	34.4	42.7	20.6	37.9	33.2
HW1095 (mutant)	29.0	43.3	49.1	21.6	45.8	40.0
MACS-2846 (<i>T. durum</i>)	34.7	38.6	46.4	12.4	41.8	37.5
MACS-2496 (<i>T. aestivum</i>)	45.3	40.0	47.0	12.5	43.2	40.4
S.E. mean	0.64	0.66	1.08	0.44	0.44	
CD	1.8	1.8	3.0	1.3	1.2	

The study reported here showed that an induced mutation resulted in reduction in height and insensitivity to externally applied gibberellin. The absence of amplification with primers specific to wild-type allele or the known dwarfing genes and GA₃ insensitivity indicated that there was a different mutation at the *RhtB1* locus.

BIBLIOGRAPHY

- Galletti, G.C. *et al.* Fiber composition of a neglected wheat species (*Triticum dicoccum* Schubler) as determined by pyrolysis /gas chromatography/mass spectroscopy. *J. Agric. Food Chem.* **44**, 3133 (1996).
- D'Autoano, L.F. *et al.* Fiber quality of emmer (*Triticum dicoccum* Schubler) and einkorn wheat (*T. monococcum* L.) landraces determined by analytical pyrolysis. *J.Sci. Food Agric.* **88**, 213 (1998).

3. Yenagi, N. B. *et al.* Glycemic and lipidemic responses to dicoccum wheat (*Triticum dicoccum*) in the diet of diabetic patients, *International Journal of diabetes in developing countries*. **21**, 153 (2000).
4. Spielmeier, W. *et al.* Identification and validation of markers linked to broad-spectrum resistance gene *Sr2* in wheat (*Triticum aestivum* L.). *Crop Sci.* **43**, 333 (2003).
5. Hussein, S. *et al.* Chromosome locations of leaf rust resistance genes in selected tetraploid wheat through substitution lines. *Euphytica* **141**, 209 (2005).
6. Nayeem, K.A., Sivasamy, M., HW1095: Pusa dwarf dicoccum has high yield performance across the Indian zones. *Annual Wheat Newsletter* **52**, 66 (2006).
7. Worland, A.J. *et al.* Genetic analysis of dwarfing gene *Rht8* in wheat. Part II. The distribution and adaptive significance of allelic variants at the *Rht8* locus of wheat as revealed by microsatellite screening. *Theor. Appl. Genet.* **96**, 1110 (1998).
8. Hanchinal, R.R. *et al.* "Current status of emmer wheat (*Triticum dicoccum*) (Schränk.) (Schulb.) cultivation in India", Wheat for Tropical Areas (Proc. Symp. Mumbai, 2006), (K. A. Nayeem, M. Sivasamy and S. Nagarajan (Ed.), Laserpark printers, Coimbatore, India, 117-125 (2004).
9. Saghai-Marouf, M.A. *et al.* Ribosomal DNA spacer-length polymorphisms in barley: Mendelian inheritance, chromosome location and population dynamics. *Proc. Natl. Acad. Sci. (USA)* **81**, 8014 (1984).
10. Ellis, M.H. *et al.* Perfect markers for *RhtB1b* and *RhtD1b* dwarfing genes in Wheat. *Theor. Appl. Genet.* **105**, 1038 (2002).
11. Sambrook, J., Molecular cloning: a laboratory manual. Cold Spring Harbor Laboratory Press, Cold Spring Harbor, New York (1989).
12. Nayeem, K.A., Sivasamy, M., "Pusa dwarfing genes in *T. turgidum* var dicoccum through nuclear technique and their inheritance", Wheat for Tropical Areas (Proc. Symp. Mumbai, 2004), (K. A. Nayeem, M. Sivasamy and S. Nagarajan (Ed.), Laserpark printers, Coimbatore, India, 55-63 (2006).
13. Bhagwat, M.D. *et al.* "Alternative dwarfing genes for the improvement of dicoccum wheat", Trends in Research and Technologies in Agriculture and Food Sciences (Proc. Symp. Mumbai, 2006), Bhabha Atomic Research Centre, Mumbai, India (2006).

Genetic Analysis and Gene Mapping of Dwarf Mutant Rice CHA-1

H Wang^{*}, Z Chen, T Guo, Y Liu & H Li

Abstract

The dwarf mutant rice CHA-1 which is studied here, is a stable and inherited rice material selected from the induced generation derived from rice variety Tehuazhan, which had been flown on a high space balloon. In order to investigate the inheritance of the dwarf genes in CHA-1, crosses between CHA-1 and tall variety Huiyangzhenzhuzao were carried out. Genetic analysis of the height in the F₂ generation showed that the new mutant gene (temporarily named *h*) from CHA-1, was a major recessive gene which linked with *sd-1* to a certain extent. The two genes had complementary interaction and together controlled the dwarf trait of CHA-1, which therefore was *hhsd-1sd-1*. To map the locus of the dwarf gene *h*, bulked-segregate analysis and recessive-class analysis in the F₂ generation from the cross between CHA-1 and variety 02428 were used to screen SSR molecular markers which are distributed throughout rice chromosomes, and find the SSR markers linked with the dwarf gene *h*. Finally, the genetic map of the dwarf gene *h* was constructed.

Introduction

Plant height character is one of the most important agronomic traits of rice. Far-ranging utilization of the semi-dwarf gene *sd-1*[1] had made a great breakthrough in the rice production. This great achievement is well known as the "green revolution" in the breeding history of rice. However, the frequent use of a single gene source was hiding inherited brittleness. Thus, identification and utilization of non-*sd-1* gene sources is an important subject for present rice breeding. Space mutation is one of the effective ways to create new dwarf rice germplasm. The special dwarf mutant rice CHA-1 was obtained by space mutation. Compared with its original variety, the main agronomic characters of CHA-1 showed strong variation. The plant height decreased to only half of the original, 55~65centimeters. At the same time, positive variations were found in terms of panicle number, grain length-width rate, inartificial out-crossing rate and exterior quality. In addition, the hybrids which cross between CHA-1 and different tall varieties showed significant heterosis. In order to identify and apply the new dwarf rice source CHA-1 in rice breeding, genetic analysis and mapping of the dwarf gene *h* were studied.

Materials and Methods

Materials

- Dwarf mutant rice CHA-1 (*indica*)
- Tehuazhan (original variety, had semi-dwarf gene *sd-1*, *indica*)
- Aijiaonante (had semi-dwarf gene *sd-1*, *indica*)
- Huiyangzhenzhuzao (high variety, *indica*)
- 02428 (had semi-dwarf gene *sd-1*, *japonica*)

Methods

7022 resin slides of the neck internodes from adult plants of CHA-1, Tehuazhan and Aijiaonante were made, and the longitudinal structures of them were examined under the microscope (40×).

A cross between CHA-1 and Huiyangzhenzhuzao was carried out, and then the height of every adult plant of the F₁ and F₂ generations measured.

Bulked-segregate analysis and recessive-class analysis in F₂ generation from the cross between CHA-1 and variety 02428 were used to screen SSR molecular primers which are distributed throughout rice chromosomes, and find the SSR markers linked with the dwarf gene *h*. Finally, the genetic map of the dwarf gene *h* was constructed.

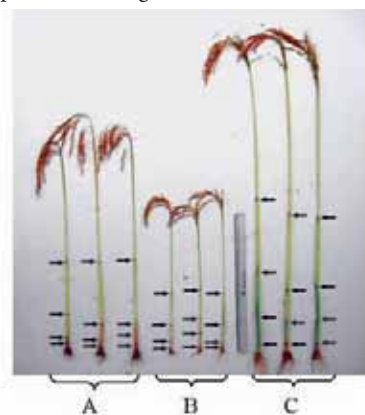

Figure 1 Elongation pattern of internodes. (A) Aijiaonante, (B) CHA-1, (C) Tehuazhan.

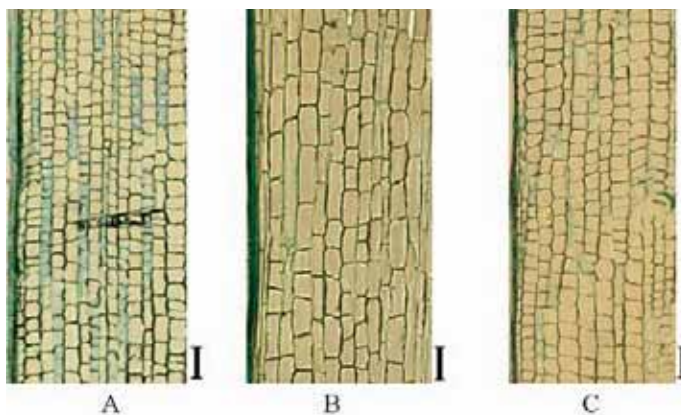

Figure 2 Longitudinal structure of neck internodes. (A) Aijiaonante, (B) CHA-1, (C) Tehuazhan.

Results

Characteristics of the dwarf mutant rice CHA-1

The internodes of the dwarf mutant rice CHA-1 were measured, and were all found to be shorter than those of Tehuazhan and Aijiaonante

College of Agriculture, South China Agricultural University (SCAU), Guangzhou, China

E-mail: wanghui@scau.edu.cn

(had semi-dwarf gene *sd-1*). But the proportion of every internode elongation was normal and therefore, CHA-1 could be classified as dn-type dwarf mutant rice (Fig. 1).

Internode elongation is caused by cell division in the intercalary meristem, followed by cell elongation in the elongation zone. Therefore, dwarfing could be the result of a defect in one or both of these processes. To distinguish between these possibilities, the neck internodes from adult plants were examined under the microscope. Figure 2 shows the cell morphology of the neck internode in CHA-1, Tehuazhan and Aijiaonante. CHA-1 had the shortest internode and longest internode cells. The result showed that the shortened internodes of CHA-1 could be due to the decreased number of internode cells.

Genetic analysis of height in CHA-1

In order to investigate the inheritance of the dwarf genes in CHA-1, crosses were carried out between CHA-1 with the original variety Tehuazhan and variety Aijiaonante (had semi-dwarf gene *sd-1*). Their F₂ segregated populations were used for genetic analysis. The ratio of high progeny to dwarf progeny was approximately 3:1, showing that their segregate patterns were according to one major gene, and that the dwarfism was not allelic to *sd-1*.

Furthermore, an F₂ population was constructed from the cross between CHA-1 and the tall variety Huiyangzhenzhuzao (with the homologous dominant gene *SD-1*). The plant height at ripening stage of each plant in the F₂ population was tested, and the data was collected to make a frequency distribution histogram of plant height (Fig. 3) and to perform an analysis by chi-square (χ^2) test (Table 1).

From Figure 3 we can see the distinct separation of the tall and dwarf progeny in the F₂ population, and that the plant height distribution presented two continuous kurtosis, which also showed the pattern of segregation of the major gene. The ratio appeared to be 1.58 tall: 1 dwarf, but not 3:1 or 15:1. Theoretically, CHA-1 was crossed with the tall variety with homologous dominant gene *SD-1*. Three possibilities would occur to in its F₂ population:

1. If the new gene and *sd-1* were on the same chromosome but not interacting, the segregation ratio of the F₂ population would be 3 tall: 1 dwarf;
2. If the dwarfism phenotype was controlled by these two recessive genes without linkage, then the segregation ratio of the F₂ population would be 9 tall: 6 semi-dwarf: 1 dwarf;
3. If *h* and *sd-1* were linked with complementary interaction, and they were controlling the dwarfism phenotype together, any gene that became homologous would cause dwarfism. Then, the segregation ratio of F₂ population would be among 3: 1 and 9: 7 (1.29: 1).

According to the results above, it can be assumed that the mutation gene *h* from CHA-1 was linked with *sd-1* to a certain extent. The two genes had complementary interaction. Therefore, the genotype of CHA-1 was *hhsd-1sd-1*.

Table 1. Segregation pattern of the F₂ population from the cross of CHA-1 and huiyangzhenzhuzao

Cross	Plant height packet	Actual proportion	Theory proportion	χ^2	
CHA1/ huiyangzhenzhuzao	high plant	dwarf plant	1.58:1	3:1	9.76
	617	391		9:7	102.23
$\chi^2_{0.01}=6.63$, $\chi^2_{0.05}=3.84$, $v=1$					

Mapping of dwarfing gene in CHA-1

To map the dwarf gene *h* locus, the mapping population consisted of the F₂ population from the cross between CHA-1 and semi-dwarf variety

02428 (which had the homologous dominant gene *sd-1*). Firstly, the DNA polymorphisms of two parents CHA-1 and 02428 were analyzed by using more than 200 pairs of rice SSR primers, which are distributed throughout rice chromosomes. Then, the SSR markers which showed various polymorphisms amongst the two parents, were filtrated. Secondly, the tall gene pool was built by blending the equivalent DNA of 10 tall individuals from the F₂ population. The dwarf gene pool was built in the same way. Thirdly, the polymorphism markers filtrated above were used to analyze the tall and dwarf gene pool (compared to the parents), then the marker RM302 on the long arm of rice chromosome 1 was found to have a linkage relationship with dwarf gene *h*. So, RM302 was used to detect the dwarf individuals from the F₂ population, whereby 12 recombinants were found in the 128 dwarf individuals. By analyzing the recombination individuals the dwarf gene *h* was finally mapped at a genetic distance of 4.715 cM from RM302 and of 5.915 cM from *sd-1* (Fig. 4).

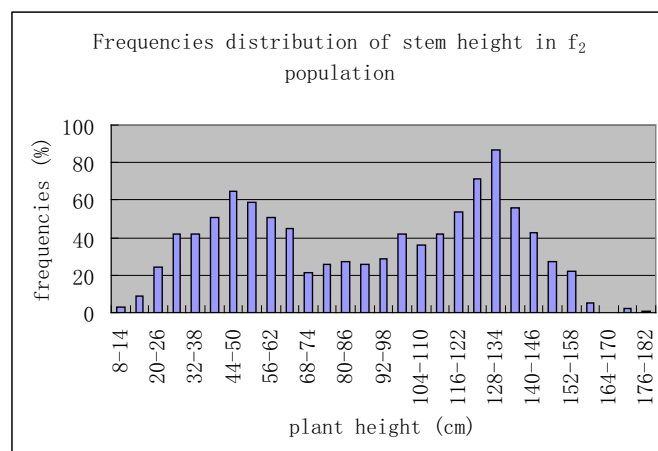

Figure 3 Frequency distribution histogram of plant height in the F₂ population from the cross of CHA-1 and Huiyangzhenzhuzao.

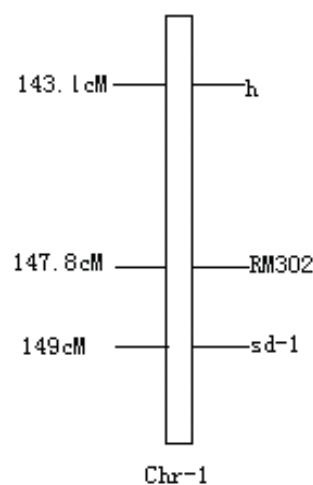

Figure 4 The genetic location of RM302, *h* and *sd-1* on chromosome 1.

Discussion

To date, the dwarfing genes *sd-1*, *d2*, *d18* (*d25*), *d10* (*d15*, *d16*) and *d61* were located in the rice chromosome 1. In this paper, results of genetic analysis and dwarfing gene mapping of CHA-1 have shown that *h* and *sd-1* were not allelic. In addition, *d2* and *d18* (*d25*) were abnormal dwarfing genes. Gene *d2* had a linkage genetic distance of 15.6 cM to molecular marker Npb359[3], and *d18* (*d25*) had a linkage genetic distance of 4.1

cM to molecular marker Npb96 [2]. Gene *d10* (*d15*, *d16*) was a dwarfing gene with many panicles, mapped to the short arm of chromosome 1, with linkage to the molecular marker RG462 [4]. And *d61* was mapped to the long arm of chromosome 1, with tight linkage to the RFLP marker C1370 [5]. Which indicated that *h* was not allelic to the dwarf genes above. So, we could infer that *h* was a new dwarf gene in rice.

This study and identification of the new dwarf gene *h* from CHA-1 will enrich the variety of dwarf rice resources. At the same time, the results obtained in this research laid a theoretical foundation for the application of the new dwarf mutant CHA-1 in rice breeding.

BIBLIOGRAPHY

1. Cho, Y.G., Eun, M.S., McCouch, S.R. *et al.* The semi-dwarf gene, *sd-1*, of rice (*Oryza sativa* L.). Molecular mapping and marker-assisted selection. *Theor. Appl. Gene.* **89**(1), 54-59 (1994).
2. Ideta, O., Yoshimura, A., Matsumoto, T. *et al.* Integration of conventional and RFLP linkage maps in rice, I. Chromosome 1, 2, 3 and 4. *Rice Genet Newsl.* **9**, 128-129 (1992).
3. Ideta, O., Yoshimura, A., Ashikati, M. *et al.* Integration of conventional and RFLP linkage maps in rice, III. Chromosomes 5, 7, 8, and 12. *Rice Genetic Newsl.* 11116-117 (1994).
4. Yu, Z.H. Molecular mapping of rice (*Oryza sativa* L.) genes via linkage to restriction fragment length polymorphism (RFLP) markers. PhD dissertation, Cornell University (1991).
5. Yamamuro, C., Ihara, Y., Wu, X. Loss of function of a rice brassinosteroid insensitive homolog prevents internode elongation and bending of the lamina joint. *Plant Cell.* **191**(12), 1591-1606 (2000).

Genetic Analysis and Mapping of Mutant Dwarf Gene *iga-1* in Rice

Z Chen*, T Guo, H Wang, J Zhang & D Rao

Abstract

The rice material Hangai-1 that is studied here is a stable dwarf mutant obtained by space mutation of rice cultivar Texianzhan 13 (*indica*). Genetic analysis showed that its dwarf trait was controlled by two recessive semi-dwarf genes, *sd1* and a new semi-dwarf gene, named *iga-1*. This new semi-dwarf gene *iga-1* was located between microsatellite markers RM6645 and RM3837 on chromosome 5, the genetic distances between them were 0.07cM and 1.21cM, respectively. The *iga-1* gene is possibly a multiple allele to the *d-1* gene. The semi-dwarf mutant with the new semi-dwarf gene *iga-1* was found to be insensitive to gibberellin 3(GA₃).

Introduction

Application and widespread adoption of dwarf rice varieties was one of the greatest achievements in rice breeding in the 20th century. However, there were only a few kind of dwarf sources used in rice breeding, and genetic analysis revealed the dwarf genes of these sources were mainly limited to *sd-1* and its alleles [1]. It is well known that the narrow background of variation and frequent use of single gene sources might become a potential bottleneck for crop breeding [2]. Therefore, exploiting, identifying and utilizing new useful semi-dwarf genes is an important subject for practical rice breeding. Space mutation has exhibited a wide application prospect in breeding [3-6]. In this study, the dwarf genetic characteristics and molecule mapping of Hangai-1 were analyzed, and the new rice semi-dwarf gene *iga-1* was identified from Hangai-1.

Materials and Methods

Dwarf genetic analysis of Hangai-1

Hangai-1 was crossed with a tall rice variety (Huiyangzhenzhuzao) and three semi-dwarf varieties (Texianzhan13, Aijiaonante, 02428) with semi-dwarf gene *sd-1* in the autumn of 2006. The parent, F₁ progenies and F₂ generation were planted in 2007.

Gene Mapping of the *iga-1* gene

A cross was made of *indica* variety Hangai-1 and *japonica* variety 02428 in the autumn of 2006. The parent, F₁ progeny and F₂ population were planted in 2007. The 912 F₂ dwarf population was selected as mapping population.

Insensitive to exogenous gibberellin GA₃ of the *iga-1* semi-dwarf mutant

Seedling sensitivities of the *iga-1* semi-dwarf mutant, Hangai-1, Aijiaonante, Texianzhan13 and Huiyangzhenzhuzao to 5mg/L, 10mg/L, 20mg/L, 30mg/L, 40mg/L gibberellin 3(GA₃) were investigated.

Results

Dwarf genetic analysis of Hangai-1

Hangai-1 was crossed with a tall rice variety (Huiyangzhenzhuzao) and three semi-dwarf varieties (Texianzhan13, Aijiaonante, 02428) with semi-dwarf gene *sd-1*. The F₁ progenies were as tall as the taller parent (Table 1), the dwarf trait of Hangai-1 being controlled by recessive nuclear gene. The segregation of the F₂ generation of Hangai-1 and Huiyangzhenzhuzao appeared to be 9 tall: 6 semi-dwarf: 1 dwarf, which indicated that the dwarfism of Hangai-1 was controlled by two recessive semi-dwarf genes without linkage (Table 2). The allelism test showed that one semi-dwarf gene of Hangai-1 was allelic to *sd-1* gene and the other was a new one, nonallelic to *sd-1* gene and named as *iga-1*. The two recessive semi-dwarf genes have similar genetic effect and accumulated effect exists.

Table 1. Plant height of the parents and their F₁ hybrids.

Cross P ₁ /P ₂	Plant height cm				F ₁ -MP
	P ₁	P ₂	F ₁	MP	
Hangai-1/Huiyangzhenzhuzao	52.8±0.9	128.6±1.3	136.5±2.1	90.7	45.8
Hangai-1/Texianzhan13	52.8±0.9	114.1±1.5	115.3±2.4	83.5	31.8
Hangai-1/02428	52.8±0.9	97.3±1.3	121.2±1.8	75.3	45.9
02428/ Hangai-1	97.8±1.0	52.8±0.9	116.3±1.2	75.3	41.0

Table 2. Segregation of plant height in F₂ populations derived from the crosses between Hangai-1 and Texianzhan 13, Huiyangzhenzhuzao, respectively.

Cross	Plant height packet			Actual proportion	Theory proportion	χ ²
	High plant	Semi-dwarf plant	Dwarf plant			
Hangai-1/Texianzhan13		813	237	3.43:1	3:1	3.4
Hangai-1/Huiyangzhenzhuzao	872	524	104	8.38:5.04:1	9:6:1	4.7

Note: χ²_{0.01}=9.21, χ²_{0.05}=5.99, v=2; χ²_{0.01}=6.63, χ²_{0.05}=3.84, v=1

Gene Mapping of a Mutant Dwarf Gene *iga-1* in Hangai-1

To map the *iga-1*, an F₂ population derived from a cross between Hangai-1 and 02428 was constructed. Using bulk analysis with SSR markers, the *iga-1* gene was located on the 58.77cM of rice chromosome 5 between two microsatellite markers RM6645 and RM3838, with genetic distance of 0.07cM and 1.21cM, respectively (Fig. 1, Fig. 2).



Figure 1 Linkage analysis between the semi-dwarf gene *iga-1* and microsatellite marker RM6645

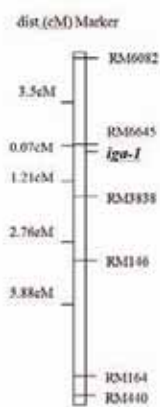

Figure 2 Fine location of the semi-dwarf gene *iga-1*. 1: Dwarf parent; 2: Crossing-over plant; 3: Tall parent.

Insensitive to exogenous gibberellin GA₃ of the *iga-1* semi-dwarf mutant

The *iga-1* semi-dwarf mutant was insensitive to exogenous gibberellin GA₃, and its wild phenotype of plant height was partially restored by exogenous GA₃. Moreover, the sensitiveness of *iga-1* was weaker than that of *sd-1*. (Fig. 3)

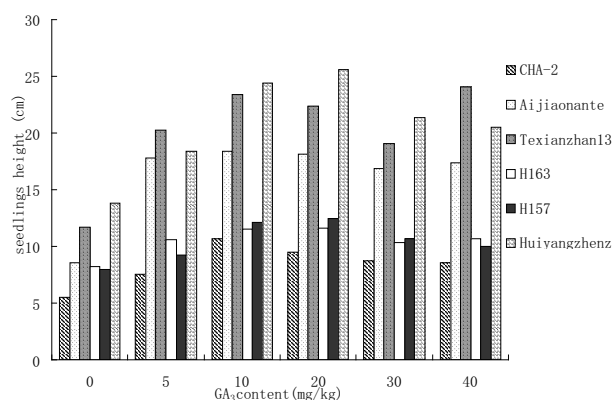

Figure 3 Height of seedling plants in response to GA₃.

Discussion

This research shows that the dwarf gene *d-1*, *d-1**, *sd-7*, *sd-g* and *sd-n* were located on chromosome 5 [7]. The *d-1* gene was located on the 59cM of chromosome 5. The *d-1** gene is possibly an allele to the *d-1* gene and a multiple allele to the *sd-n* gene [8]. The *sd-7* gene was linked to the *d-1* gene [9]. The *sd-g* was linked to the *sd-n* gene [10]. In this study, the *iga-1* gene is possibly a multiple allele to the *d-1* gene. More research on it is underway.

Dwarf mutants have a very important effect on elucidating the regulation mechanism of stem development and plant breeding. This research showed that gibberellin (GA) has a close relationship with the dwarf mutant. Approximately all of the genes involved in the biosynthesis of the biologically active GA have now been isolated, using different kinds of strategies. However, research of the GA signal transduction is scanty and must be strengthened. The development of this kind of dwarf mutants involved in gibberellin signal transduction pathway was summarized. This work will help understand gibberellin signal transduction pathway, while this development can be used for the theoretical study of gibberellins in plant production.

BIBLIOGRAPHY

- Chao, Y.G., Eun, M.Y., McMouch, S.R. *et al.* The semidwarf gene, *sd-1*, of rice (*Oryza sativa* L.). Molecular mapping and marker-assisted selection. *Theor Appl Genet.* **89**, 54-59 (1994).
- Chang, T.T., Zuro, C., Marciano-Romena A. *et al.* Semidwarf in rice germplasm collections and their potentials in rice improvement. *Phytobreedon.* **1**, 1-42 (1985).
- Planel, H., Ganbin, Y., Pianezzi, B. *et al.* Space environmental factors affecting responses to radiation at the cellular level. *Adv Space Res.* **9** (10), 157-160 (1989).
- Li, J.G., Liu, G.Q., Zhang, J. *et al.* Study on Induced Mutation of Sorghum Seeds on Recoverable Satellites. *Space Medicine & Medical Engineering.* **14**(1), 57-59 (2001).
- Xu, J., Lin, Y., Xi, Y. *et al.* Mutation of rice after exposure to high altitude environment. *Space Medicine & Medical Engineering* **8**(3), 206-211 (1995).
- Thora, W.H. The NASA space biology program. Publication of NASA Space Biology Program. 1980-1984 (1980).
- Kinoshita, T. Report of the committee on gene symbolization. *RGN* **15**, 17-54 (1998).
- Lin, H.X., Xiong, Z.M., Min, S.K. *et al.* The Location of the Dwarf Gene in Rice Variety Xuehezaizao. *Chinese Rice Sci.* **7**(1), 17-20 (1993).
- Tsai, K.H. Tight linkage of gene *sd7* (t) and *d1* found in a cross of Taichung 65 isogenic. *RGN* **8**, 104 (1991).
- Liang, G.H., Gu, M.H., Pan, X.B. *et al.* Chromosome Location of a Semidwarf Gene *sd-g* in indica (*O. sativa* L.). *Acta Botanica Sinica* **21**(4) 297-304 (1994).

Selection of Wheat Mutant Genotypes Carrying HMW Glutenin Alleles Related to Baking Quality by Using PCR (STS method)

M J Zamani^{1,*}, M R Bihanta², B Naserian Khiabani³ & M T Hallajian³

Abstract

This study was performed in the Agriculture, Medicine and Industry Research School, Nuclear Science and Technology Research Institute of Iran in 2005-2006, through Polymerase Chain Reaction by using Sequence Tagged Site (STS) method, to characterize in terms of bread quality of some wheat mutant genotypes (Roshan, Omid, Tabasi, Azar and Azadi), their parents and other cultivars such as Chamran, Enia, Bezostaya, Tajan, Pishtaz and Chinese spring. Twelve pairs of primers were used in this study; seven of them were extracted from the literature and the others were designed from the D genome subunits sequences of wheat. Some studies on drought resistance, salt resistance, etc., have been done for these mutant genotypes, some of them showing good results. However, their baking quality has not been studied before. The alleles Dx2+Dy12 (with negative effect on bread quality) and Dx2*, Dx5+Dy10 (with positive effect on bread quality) had the main effect on wheat bread quality. Special primers of these subunits were used to amplify these alleles. Except for the cultivars that had Dx5+Dx10, six mutant genotypes whose parents did not have these alleles (T-66-58-60, Ro-5, Ro-4, Ro-3, Ro-1 and O-64-1-10), showed Dx5+Dx10. SDS-PAGE analyses showed no contradictory results with molecular experiments. Significant differences were seen on protein percentage for polymorphic mutant genotypes, Ro-1, Ro-3 and Ro-5 with Roshan (their parent), at 1% probability level.

Introduction

Wheat (*Triticum aestivum* L.) is one of the most important cereal crops in the world and baking quality is an increasingly important trait, since it defines the uses and marketability of wheat products. Although the protein fraction of wheat seed known as gluten is associated with baking quality, High Molecular Weight (HMW) glutenins are the subunits most closely associated with this trait. These proteins have conserved amino and carboxy domains with Cys residues and a repetitive hydrophobic central domain. The homologous loci *Glu-A*, *Glu-B* and *Glu-D* control the synthesis of HMW glutenins and are found on linkage group 1 of their respective homologous genomes in wheat. Each loci encodes two subunits of different molecular weights, *x* and *y*. These subunits present a tight genetic linkage and are frequently reported as the *x* + *y* pair. Several independent studies report the close association between the allelic pair HMW_{x5+y10} at the locus *Glu-D1* and improved baking quality, whereas the opposite applies to the allelic pair HMW_{x2+x12} [1,2]. Also, it has been demonstrated that good bread making quality is firmly associated with the presence of *Glu-A1x2**. Moreover, *Glu-A1x-Null* and *Glu-D1 x2+y12* were associated with small sedimentation volumes [3]. The nucleotide sequences of the alleles *Glu-A1 x1* and *x2** have been reported

[4, 5]. The sequences of genes *Glu-A1x2** and *Glu-D1x5* were analyzed comparatively [4], showing that these genes have a similar structure and a high similarity. Recently, many authors used PCR-based analysis to distinguish between cultivars with different HMW glutenin subunits [6, 7, 8, 9]. Also, other genetic markers based on the PCR method as RAPDs and AFLP were used to identify polymorphism in DNA, and for practical use in recovering the genetic background of the recurrent parent during backcrossing in plant breeding programs. This paper reports the application of specific markers (STS method) as one of the best methods to amplify the coding sequence of each specific allele of the *Glu-A1* and *Glu-D1* genes that are related to baking quality.

Table 1. PCR cycling conditioned for the amplification of specific alleles of genes *Glu-A1* and *Glu-D1*

Final Extension		Extension		Annealing		Primers
Time	Temp	Time	Temp	Time	Temp	
6'	72	1'	72	1'	64	P1P2
6'	72	1'	72	1'	65	P3P4
6'	72	1'	72	1'	66	P5P6
7'	70	2.20"	70	1'	58	P7P8
7'	70	2.30"	70	1'	66	P9P10
7'	70	2.10"	70	1.40"	60	P11P12
7'	70	2.30"	70	1'	61	P13P14
7'	72	2'	70	1'	61	P15P16
7'	70	1'	70	1'	59.5	P17P18
7'	70	2'	70	50"	62	P19P20
7'	70	2'	70	50"	60	P21P22
7'	70	3'	70	1'	59.5	P23P24

Table 2. Primer sequences used to amplify HMW glutenin subunits.

Forward PCR primers (5'.....3')	Reverse PCR primers (5'.....3')
P1 = 5' ACCTTATCCATGCAAGCTACC 3'	P2 = 5' CATGGCAGCCGACCGGCCAAC 3'
P3 = 5' GTTGGCCGGTCGGCTGCCATG 3'	P4 = 5' TGGAGAAGTTGGATAGTACC 3'
P5 = 5' GCCTAGCAACCTTACAATC 3'	P6 = 5' GAAACCTGCTGCGGACAAG 3'
P7 = 5' AGCCTAGCAACCTTCAAC 3'	P8 = 5' AGCATGCAGCACATACC 3'
P9 = 5' CTAACCTCGCGTGCACA 3'	P10 = 5' AGCTAAGTGCATGCATG 3'
P11 = 5' CTCGTCCTATAAAAGCCTAGT 3'	P12 = 5' GAGACATGCAGCACATACT 3'
P13 = 5' AGCTAAGGTGCATGCATG 3'	P14 = 5' CTAACCTCGCGTGCACA 3'
P15 = 5' ATGGCTAAGCGGTTAGTCCTC 3'	P16 = 5' GCATTGTCGGCCAGCCAGTGA 3'
P17 = 5' GCATTGTCGGCCAGCCAGTGA 3'	P18 = 5' ACAAGGGCAACAAGGTCAGCA 3'
P19 = 5' GCATTGTCGGCTAGCCAGTGA 3'	P20 = 5' ATGGCTAAGCGGCTGGTCCTC 3'
P21 = 5' ATGGCTAAGCGGTTAGTCCTC 3'	P22 = 5' ACAAGGGCAACAAGGTCAGCA 3'
P23 = 5' ATGGCTAAGCGGTTGGTCCTC 3'	P24 = 5' AGGACAAGGGCAACAGTCAGG 3'

Materials and Methods

Genomic DNA was extracted by CTAB method from 6-8 g of fresh leaves from Tabasi mutants (T-65-9-1P, T-66-58-6, T-66-58-9, T-65-6, T-65-5-1, T-66-58-10, T-66-58-12, T-65-4, T-65-9-1, T-67-7-1, T-58-8, T-58-7, T-66-I-II, T-67-60, T-58-14, T-65-9-II-4 and T-66-58-60), Omid mutants (O-64-1-1, O-64-4 and O-6-1-1), Roshan mutants (Ro-1, Ro-2, Ro-3, Ro-4, Ro-5, Ro-6, Ro-7, Ro-8, Ro-9, Ro-10, Ro-11 and Ro-12), As-48 (Azadi mutant), Azar mutant with their parents (Tabasi, Omid, Roshan, Azadi and Azar), and some other cultivars like Chamran, Navid, Atrak, Tajan, Inia, Bezostaya, Tajan-e-garm, Pishtaz and Chinese spring,

¹ Islamic Azad University, Branch Roodehen, Agriculture Department

² Tehran University, Biotechnology Department

³ Agriculture, Medicine and Industry Research School – Nuclear Science and Technology Research Institute

* Corresponding author. E-mail: mj_zamani1980@yahoo.com

Primer P5P6 that amplifies Dx5 (450 bp) was from [12,13], while primers P7P8, P9P10, P11P12 and P13P14 were from [9]. P7P8 amplifies Dx5 (2775 bp), but this band did not appear in spite of many changes performed to the method. However, there were two bands of 550 bp and 1350 bp, that were not specific for Dx5, and which appeared on all the genotypes. P9P10 amplifies Dy10 (2135 bp), P11P12 amplifies Dx2 (2799 bp) and P13P14 amplifies Dy12 (2190 bp). Other primers (P15 up to P24) were designed from the D genome subunit sequences. P15P16 should amplify Dx5 (2520 bp), also P17P18, P19P20, P21P22 and P23P24 should amplify Dx2.1 (651 bp), Dy10 (1947 bp), Dx2.1 (1876 bp) and Dy12 (1947 bp) respectively, but none of these bands appeared.

Our results showed that the best primers for Marker Assisted Selection are P3P4 and P5P6. P3P4 is the best because obtaining specific bands in this primer is easier and it also shows three specific bands for Dy10, Dy12 and By9.

This study shows that six mutant genotypes (T-66-58-60, Ro-1, Ro-3, Ro-4, Ro-5 and O-64-1-1) carry alleles alike the genotypes that have good baking quality (Chamran, Tajan, Bezostaya, etc), although their parents do not have these alleles.

Protein percentage for mutant genotypes (Table 4) showing polymorphism, as in Ro-1, Ro-3 and Ro-5 were different from Roshan (their parent) at 1% probability level.

In three genotypes (T-65-9-1, T-65-9-1p and Ro-9,) mutation caused a change in By9 sequencing.

P3P4 primers were the best primers when considering three alleles at the same time and the bands that appeared were sharper than the others (maybe because of the size of these bands). Also, using multiplex PCR is recommended in the situation where there are bands of different sizes.

Thus, in order to validate the results of molecular tests, the SDS-PAGE method was undertaken, with results as shown in the gels of Figures 3 and 4.

Table 3. Summary of protein percentage (CV=2%) analysis

(Ms)	(S.O.V)	(Df)
Genotype	10	5.3269**
Error	22	0.05

Table 4. Comparing of protein mean by Duncan's multiple-range test

Genotype	Mean protein percentage	Ranking
Ro-3	13.3	A
Roshan	12.6	B
Ro-4	12.3	B
Ro-5	12	C
Ro-1	11.8	C
Omid	10.6	D
O-64-10-10	10.6	D
Azar	10.2	E
T-65-9-1P	9.8	F
T-65-58-60	9.8	F
Tabasi	9.3	F

BIBLIOGRAPHY

- Shewry, P. *et al.* The prolamin storage proteins of wheat and related cereals. *Prog. Biophys. Molec. Biol.* **61**, 37-59 (1994).
- Shewry, P. *et al.* Biotechnology of wheat quality. *J. Sci. Food. Agric.* **73**, 397-406 (1997).
- Odenbach, W., Mahgoub, El-S. Relationships between HMW glutenin subunit composition and the sedimentation value in reciprocal sets of inbred backcross lines derived from two winter wheat crosses. *Proc 7th Int Wheat Genet Symp, Ca. bridge*, 987-991 (1988).
- Anderson, O.D., Greene., F.C. The characterization and comparative analysis of high-molecular-weight glutenin genes from genomes A and B of hexaploid bread wheat. *Theor. Appl. Genet.* **77**, 689-700 (1989).
- Halford, N.G. *et al.* Analysis of HMW glutenin subunits encoded by chromosome 1A of bread wheat (*Triticum aestivum* L.) indicates quantitative effects on grain quality. *Theor. Appl. Genet.* **83**, 373-378 (1994).
- D'ovidio, R. *et al.* PCR analysis of genes encoding allelic variants of high-molecular-weight glutenin subunits at the Glu-D1 locus. *Theor. Appl. Genet.* **88**, 175-180 (1994).
- D'ovidio, R., Anderson, O.D. PCR analysis to distinguish between alleles of a member of a multigene family correlated with wheat bread-making quality. *Theor Appl Genet* **88**, 759-763 (1994).
- Varghese, J.P. *et al.* Rapid screening of selected European winter wheat varieties and segregating populations for the Glu-D1d allele using PCR. *Plant Breeding* **115**, 451-454 (1996).
- Debost, A. *et al.* Molecular characterization of the inactive allele of the gene Glu-A1 and the development of a set of AS-PCR markers for HMW glutenins of wheat. *Theor. Appl. Genet.* **100**, 1085-1094 (2000).
- Shewry, P. *et al.* High-molecularweight subunits of wheat glutenin. *J. Cereal Sci.* **15**, 105-120 (1992).
- Smith, R.L. *et al.* Identification of glutenin alleles in wheat and triticale using PCR-generated DNA markers. *Crop Sci.* **34**, 1373-1378 (1994).
- Ahmad, M. Molecular marker-assisted selection of HMW glutenin alleles related to wheat bread quality by PCR-generated DNA markers. *Theor. Appl. Genet.* **101**, 892-896 (2000).
- Zuniga J. *et al.* Selection of Chilean wheat genotypes carriers of the HMW Glu-D1 x5 through Polymerase Chain Reaction. *Agricultura Tecnica (Chile)* **64**(3), 223-228 (2004).
- Debost, A. *et al.* Marker assisted selection to improve HMW-glutenins in wheat. *Euphytica* **119**, 69-73 (2001).

ACKNOWLEDGEMENTS

Special thanks to the researchers of Agriculture, Medicine and Industry Research School, Nuclear Science and Technology Research Institute of Iran and the colleague at the Islamic Azad University branch Roodehen and Karaj.

Isolation and Characterization of Retrotransposons in Wild and Cultivated Peanut Species

S Nielsen^{1,*}, F Campos Fonseca¹, P Guimarães¹, S C Leal-Bertioli¹ & D Bertioli²

Abstract

Retrotransposons are considered a possible source for mutations due to their potential of spreading in the genome using a “copy and paste”-like mechanism. Here we report on the isolation and characterization of a new Ty3-*gypsy* retrotransposon from allotetraploid peanut (*Arachis hypogaea*, 2n=4x=40) and its diploid ancestors *A. duranensis* (AA-genome, 2n=20) and *A. ipaënsis* (BB-genome, 2n=20). We have identified two repetitive sequences, one showing high similarity at the amino acid level to the reverse transcriptase of *Athila*-type retrotransposons, the other being AT-rich with no similarities to gene bank sequences. Results from genome walking experiments gave first evidence that both sequences represented parts of the same Ty3-*gypsy* retrotransposon, the 5'-LTR (long terminal repeat)- and the *pol* (polyprotein)-region respectively. Fluorescent *in situ* hybridization (FISH) experiments showed that the element is dispersedly distributed on the chromosomes, absent from centromeres and telomeric regions, and more prominent in chromosomes of the A-genome. The element appeared to be moderately repetitive with copy numbers of about 830 (*A. ipaënsis*), 2,600 (*A. duranensis*), and 3,000 (*Arachis hypogaea*) per haploid genome. Phylogenetic analysis of the deduced amino acid sequences of 80 isolated reverse transcriptase clones from the three species shed light on its evolution within the peanut species. The isolated sequences contained multiple stop-codons and so far, no evidence has been found that the element is still active. An outlook is given regarding finding new tools for the advancement of *Arachis* breeding programs aimed at the transfer of resistance to biotic and abiotic stresses to peanut.

Introduction

Cultivated peanut (*Arachis hypogaea*) is an allotetraploid species (AABB genome, 2n = 4x = 40), which derived from a single hybridization event between two diploid *Arachis* species and subsequent spontaneous chromosome doubling. Recent studies including those based on fluorescent *in situ* hybridization using rDNA sequences as probes suggest that *A. duranensis* (AA, 2n = 20) and *A. ipaënsis* (BB, 2n = 20) are the most probable ancestors [1, 2]. Its low genetic diversity is the major bottleneck that hampers crop improvement programs and genetic studies in peanut. In contrast, most wild *Arachis* species are diploid with high genetic diversity, and moreover, some are a source for resistance to important biotic and abiotic stresses. In order to elucidate the relationships of wild and cultivated peanut genomes, thereby improving our ability to efficiently introgress wild genes into the peanut crop, repetitive elements, especially retrotransposons, are an interesting research object.

Retrotransposons are mobile genetic elements present in many different organisms. Active elements replicate through a mechanism of reverse transcription and insertion of a new copy into new chromosomal sites, where they can cause mutations (for a recent review on their life cycle see

[3]). Retroelements, particularly the LTR (long terminal repeat) retrotransposons, constitute the major part of repetitive DNA and contribute substantially to genome size [4, 5]. Based on phylogenetic analysis of their reverse transcriptase (*rt*) sequences and on structural differences LTR-, retrotransposons can be divided into two major lineages, one consisting of the Ty1-*copia* retrotransposons (*pseudoviridae*), and the other of the Ty3-*gypsy* retrotransposons (*metaviridae*) [6, 7]. Retrovirus-like retrotransposons are characterized through an additional open reading frame (ORF) encoding transmembrane domains, which are characteristic for envelope (*env*) genes. Examples of retrovirus-like transposon families are the Ty3-*gypsy* retrotransposons *Athila* [8], *Cyclops* [9], and *Calypso* [10]. Several LTR-retrotransposons have been reported to be present in legumes. The first indication for presence of an LTR retrotransposon in peanut was given by Chavanne, *et al.* [9], who characterized the *gypsy*-like retrotransposon *Cyclops* in pea and detected hybridization of a fragment of its reverse transcriptase to genomic DNA of various legumes, including *A. hypogaea*. Yüksel, *et al.* [11] screened their BAC library of *A. hypogaea* and found a sequence with similarity to an *Arabidopsis copia* element.

Some elements seem to be constitutively expressed, for instance the *Ogre* element of pea [12]. Others are silent and can be activated upon certain stress signals such as tissue culture (*Tos17* retrotransposon in rice [13]), ionizing irradiation (Ty1 in *Saccharomyces cerevisiae* [14]), wounding (*Tto1* in tobacco [15]), or allopolyploidization (*Wis2-1A* in synthetic wheat allotetraploids [16]). The ability of some retrotransposons to become active again after stimulation makes them an ideal tool for inducing desired genetic variability, and also for reverse genetics approaches, as it was shown by the generation of about 50,000 rice insertion lines with *Tos 17* [17]. Furthermore, their abundance and ability to transpose make them good potential markers in form of the PCR-based techniques IRAP (inter-retrotransposon amplified polymorphism) and REMAP (retrotransposon-microsatellite amplified polymorphism) that detect retrotransposon integration events in the genome [18].

So far, with the exception of rDNA sequences [1] relatively little is known about the features and localization of repetitive elements in *Arachis* species. This applies especially to retrotransposons. Here we report on the isolation and characterization of a new *Athila*-like retrotransposon in *Arachis* species.

Materials and Methods

Plant materials and DNA extraction: Leaf and root tissue were obtained from *A. hypogaea* cv. Tatu, *A. duranensis* (accession V14167c), *A. stenosperma* (accession V10309), and *A. ipaënsis* (accession KG30076c). Plants were grown from seeds under greenhouse conditions. All plants were obtained from the Brazilian *Arachis* germplasm collection, maintained at Embrapa Genetic Resources and Biotechnology — CENARGEN (Brasília-DF, Brazil).

Cloning of reverse transcription sequences and phylogenetic analysis: To enable phylogenetic analysis of the retroelement in *A. hypogaea*, *A.*

¹ Embrapa Recursos Genéticos and Biotechnology, Brasília – Distrito Federal, Brazil

² Universidade Católica de Brasília, Brasília – Distrito Federal, Brazil

* Corresponding author. E-mail: stephan@cenargen.embrapa.br

duranensis, and *A. ipaënsis* a set of three forward (F) and three reverse (R) PCR primers have been designed to amplify the total sequence of the *Athila*-like reverse transcriptase (*rt*):

Rep-RT-F1 5'-AAGGACACACAAGACAGCTC-3';
Rep-RT-F2 5'-GTACGCACAAGATCCTATTG-3';
Rep-RT-F3 5'-CTAAATCCAGCCATGAAGG-3';
Rep-RT-R1 5'-GTCAGCTACAAGGAGATTGC-3';
Rep-RT-R2 5'-GGAGATGATAGGTGCAGAAG-3';
Rep-RT-R3 5'-TCACACATCAGTTCAAATGG-3'.

Sequence analysis and construction of contigs has been done using the Staden Package software [19]. For multiple alignment of amino acid- and DNA sequences the program ClustalX [20] has been used. The results of alignments have been utilized for construction of phylogenetic trees using the program Mega 3.1 [21].

Genome walking: In order to extend sequence information into the flanking genomic regions of the two pseudo-contigs a modified Genome Walker™ strategy has been applied. Genomic DNA of *A. hypogaea* (1.5 µg) was digested with 15 units of the restriction enzyme *PvuII*. After complete digestion the samples were purified with Phenol/Chloroform, precipitated and re-suspended in 20 µl TE_(0.1). 4 µl of the digested was used for ligation of a *PvuII* adaptor, consisting of 5'-ACTCGATTCTCAACCCGAAAAGTATAGATCCCA-3' (long arm) and 5'-Phosphate-TGGGATCTATACTT-H₂N-3'. PCR reactions have been performed with the adapter primer AP1 (5'-ACTCGATTCTCAACCCGAAAAG-3') and genome specific primers directed outwards the known sequences. For Rep-1 primer Rep-1-Out-Right-2 (5'- GTTGCCGGGATTGTTC-3') was used to amplify sequences downstream, for Rep-2 it were the primers Rep-2-Out-Left (5'-AATCATGTCTCAATTACGC-3') and Rep-2-Out-Right (5'-TGGTGACTGAAGGAATTGTC-3') for upstream and downstream amplification. PCR products have been cloned and sequenced using Sp6 and T7 sequencing primers.

Chromosome preparation and Fluorescent in situ hybridization: Root tips were collected from young plants in the greenhouse or from rooting leaf petioles that have been cultivated in humid petri dishes in an incubator with average temperature of 25° C [22]. Chromosome preparations have been made according to Maluszynska and Heslop-Harrison [23]. Pretreatment, hybridization, washing and detection procedures essentially followed protocols published by Schwarzacher and Heslop-Harrison [24] with post-hybridization washes at 83% stringency.

Results

Isolation and structure of the *Arachis* retroelement: Based on a dot blot survey of short insert libraries of *A. duranensis* and *A. ipaënsis* that were probed with genomic DNA of both species, several clones were identified resembling repetitive sequences. Using the sequences of these clones and additional gene bank sequences, two pseudo-contigs, Rep-1 and Rep-2, were established using the Staden-Package software [19]. A BLASTx search [25] revealed high similarities between one of those contigs (Rep-2) and the reverse transcriptase region of the Ty3-*gypsy* retrotransposon *Athila*. On the other hand, the Rep-1 contig was AT-rich with no similarities to any genic sequences in gene bank. Extended sequence information from both repeats was gained through a modified genome walker strategy, involving the ligation of specific adaptors to genomic restriction fragments and subsequent amplification of sequences adjacent to the repeat clones using adaptor- and repeat-specific primers. From 24 clones isolated from the right site of Rep-1, three had inserts of 1200 to 2000 bps (Fig. 1). Those three inserts showed significant similarity ($2e^{-32}$) to the *gag-pol* region of the Ty3-*gypsy* retrotransposons *Ogre* (pea) and *Athila* (*Arabidopsis*). Additionally, the new sequences resem-

bled at their 5'-end the primer-binding site (PBS) of *Calypso*- and *Athila* like retrotransposons, which is complementary to the 3'-end of the Asp tRNA. Translated sequences received from Rep-2 genome walking experiments revealed presence of conserved amino acid motifs that are characteristic for the retrovirus-like Ty3-*gypsy* elements. These results gave first evidence that Rep-1 and Rep-2 are parts of the LTR- and the *pol* region of the same Ty3-*gypsy* retrotransposon. We aimed to obtain the full sequence of this element using the recently generated BAC libraries of the *A. duranensis* and *A. ipaënsis* genomes [26]. Using PCR screening and Southern hybridization, four BAC clones have been identified that contain at least one *rt*- and two or more LTR-fragments, which implies the possibility of isolation of a complete element. According to preliminary results from PCR cloning the total length of the element is bigger than 11,000 bps and does not contain an *env*-typical ORF.

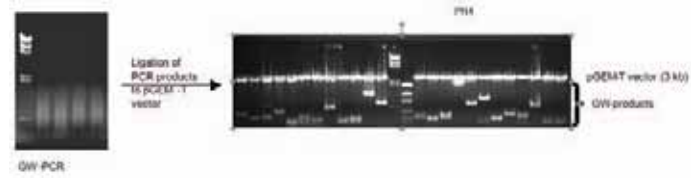

Figure 1 Cloning of sequences downstream of the isolated AT-rich repeat Rep-1. The translated sequence of clone PR4 revealed significant similarity ($2e^{-32}$) to the *gag-pol* region of the Ty3-*gypsy* retrotransposons *Athila* in *A. thaliana* and *Ogre* in pea. (GW: genome walking).

Copy Number Estimation: Copy number estimations have been made on the basis of non-radioactive dot blot hybridizations of a retrotransposon subclone against dilution series of itself and of genomic DNA from the three *Arachis* species. Subclone dilutions represented one to 100,000 copies of the retrotransposon sequence in 500 ng of genomic DNA. The strength of hybridization signals in the chemilumigraphs was

quantified using the MultiGauge software (Fucifilm) and the slope of the regression curves of the resulting plots have been used for calculating the copy numbers. The representative *rt*-subclone Ah-9 was estimated to be present in the *A. ipaënsis* genome ($2C = 2.8$ pg) with about 830 copies (equivalent to 0.7% of the genome), in *A. duraensis* ($2C = 2.61$ pg) with about 2,600 copies (equivalent to 2.3% of the genome), and in *A. hypogaea* ($2C = 5.93$ pg) with 3,000 copies (equivalent to 1.2% of the genome) per haploid genome. (Genome sizes according to Temsch and Greilhuber [27, 28].)

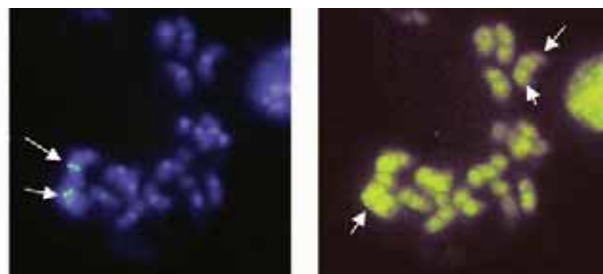

Figure 2 FISH of chromosome spread of *A. stenosperma* (A-genome). Left: hybridization with the wheat 5S-rDNA probe [29] reveals one sub-centromeric 5S-rDNA site (arrows). Right: re-hybridization with Dig-labeled LTR-probe. Note the lack of hybridization to centromeres and telomeric regions (arrows).

Chromosomal Distribution of retroelement: To determine the chromosomal distribution of the retrotransposon metaphase spreads of *A. duranensis*, *A. stenosperma* (A-genome), and *A. hypogaea* have been hybridized with Dig-labeled LTR- and reverse transcriptase probes. DAPI staining of the chromosomes revealed centromeric bands, which

are typical for the *Arachis* A-genome, whereas B-genome chromosomes do not show such bands [1]. Hybridization of A-genome chromosome spreads with the LTR probe showed dispersed distribution of the element in euchromatic regions of chromosomes and absence from heterochromatic regions, such as the centromer and telomeric regions (Fig. 2). When hybridized to metaphase spreads of *A. hypogaea*, the same probe appeared to be localized preferably in the A-genome of *Arachis*, which became obvious by comparison with the DAPI stained spreads allowing differentiation between A- and B- genome chromosomes. This kind of preferential hybridization to the A-genome was also detected when using a clone representing the reverse transcriptase as a probe (data not shown).

Phylogenetic Analysis: From 87 reverse transcriptase sequences isolated and cloned from *A. hypogaea*, *A. duranensis*, and *A. ipaënsis*, 80 have been selected for analysis of their evolution. Using Mega 3.1 the genetic distances between the sequences were calculated (Table 1). Three groups are shown, each of them contained all sequences of one species. The distances within each group and between the groups have been analyzed with regard to the nucleotide and as well the amino acid sequences. The data reveal that the DNA sequences isolated from *A. duranensis* suffered less modifications as compared to the ones from *A. hypogaea* and *A. ipaënsis*, which revealed the largest genetic distances. This trend is even more obvious when looking at the amino acid sequences, probably a result of changes in the reading frame that could have generated different amino acids.

Table 1. Genetic distances between DNA sequences and between amino acid sequences of isolated *rt*-genes from *A. hypogaea* (Ah), *A. duranensis* (Ad), and *A. ipaënsis* (Ai). The mean value corresponds to all 80 sequences of DNA and/or amino acids.

Groups	Distance between the sequences (%)	
	Seq. DNA	Seq. amino acids
Ah x Ah	8.68	18.83
Ad x Ad	8.20	17.44
Ai x Ai	8.95	19.87
Mean value	8,61	18.71

Discussion

The present work evolved from our efforts in isolating repetitive elements from the A- and B- genome of *Arachis* aimed at finding out more about the genomic relationships between the ancestors of cultivated peanut. The described element is the first characterized retrotransposon in *Arachis*. Preliminary sequencing results revealed that it belongs to the Ty3-gypsy retrotransposon family with high similarities to retrovirus-like elements, particularly to the *Athila* element from *Arabidopsis*. However, it also became clear that this new element has its own characteristics, which make it different from the related elements. FISH analysis has shown its localization in the euchromatic region of the chromosomes, and absence from centromeric and telomeric regions. This kind of distribution pattern was shown to be typical for Ty1-copia elements, such as BARE [30]. In contrast, the *Athila* element in *Arabidopsis* is associated with centromeric and pericentromeric regions [31]. We have detected preferential hybridization of the *Arachis* element to A-genome chromosomes. These results were substantiated by copy number estimations, where more than three times less copies were estimated for *A. ipaënsis* than for *A. duranensis*. Since multiple insertions of the element were found in *A. hypogaea*, *A. ipaënsis*, *A. duranensis*, and *A. stenosperma*, it can be assumed that it is an ancient component of the genus. In a phylogenetic analysis of 80 *rt*-sequences isolated from all three species, fewer mutations were found between the sequences derived from *A. duranensis* as compared to the

ones from *A. ipaënsis*. We conclude that the element was present in the common ancestor of the *Arachis* wild species at low copy number. After differentiation it amplified in *A. duranensis*, whereas in *A. ipaënsis* the amplification was low, the copy number remained stable or was even reduced through elimination. We could not find evidence for activity of the element by screening all relevant EST databases. It appeared that all sequences isolated included stop codons. Using BAC sequences we are now on the way to a more detailed analysis of this element. Further efforts are directed towards identifying elements, which can be activated thus enabling their use for induced mutations approaches.

ACKNOWLEDGEMENTS

The presented work was funded by EU INCO-DEV (ARAMAP: ICA4-2001-10072), and the Generation Challenge Program (Project # 31, and TLI).

BIBLIOGRAPHY

- Seijo, J.G., Lavia, G.I., Fernández, A., Krapovickas, A., Ducasse, D., Moscone, E.A. Physical mapping of the 5S and 18S-25S rRNA genes by FISH as evidence that *Arachis duranensis* and *A. ipaënsis* are the wild diploid progenitors of *A. hypogaea* (Leguminosae). *Amer J Bot* **9**, 1294-1303 (2004).
- Krapovickas, A., Gregory, W.C. Taxonomía del género *Arachis* (Leguminosae). *Bonplandia* **8**, 1-186 (1994).
- Sabot, F., Schulman, A.H. Parasitism and the retrotransposon life cycle in plants: a hitchhiker's guide to the genome. *Heredity* **97**, 381-388 (2006).
- San Miguel, P., Bennetzen, J.L. Evidence that a recent increase in maize genome size was caused by a massive amplification of intergene retrotransposons. *Ann. Bot.* **82**, 37-44 (1998).
- Vicient, C. M., Suoniemi, A., Anamthawat-Jónsson, K., Tanskanen, J., Beharay, A., Nevo, E., Schulman, A.H. Retrotransposon BARE-1 and its role in genome evolution in the genus *Hordeum*. *Plant Cell* **11**, 1769-1784 (1999).
- Xiong, Y., Eickbush, T.H. Origin and evolution of retroelements based upon their reverse transcriptase sequences. *EMBO J* **9**, 3353-3362 (1990).
- Kumar, A., Bennetzen, J.L. Plant retrotransposons. *Annu. Rev. Genet.* **33**, 479-532 (1999).
- Pelissier, T., Tutois, S., Deragon, J.M., Tourment, S., Genestier, S., Picard, G. *Athila*, a new retroelement from *Arabidopsis thaliana*. *Plant Mol. Biol.* **29**, 441-452 (1995).
- Chavanne, F., Zhang, D.X., Liaud, M.F., Cerf, R. Structure and evolution of Cyclops: a novel giant retrotransposon of the Ty3/Gypsy family highly amplified in pea and other legume species. *Plant Mol Biol* **37** 363-375 (1998).
- Wright, D.A., Voytas, D.F. *Athila 4* of *Arabidopsis* and *Calypso* of soybean define a lineage of endogenous plant retroviruses. *Genome Res.* **12**, 122-131 (2002).
- Yüksel, B., Bowers, J.E., Estill, J., Goff, L., Lemke, C., Paterson, A.H. Exploratory integration of peanut genetic and physical maps and possible contributions from *Arabidopsis*. *Theor Appl Genet* **111**, 87-94 (2005).
- Neumann, P., Požárková, D., Macas, J. Highly abundant pea LTR retrotransposon *Ogre* is constitutively transcribed and partially spliced. *Plant Mol Biol* **53**, 399-410 (2003).
- Hirochika, H., Sugimoto, K., Otsuki, Y., Tsugawa, H., Kanda, M. Retrotransposons of rice involved in mutations induced by tissue culture. *Proc. Natl. Acad. Sci. USA* **93**, 7783-7788 (1996).
- Sacerdot, C., Mercier, G., Todeschini, A.L., Dutreix, M., Springer, M., Lesage, P. Impact of ionizing radiation on the life cycle of *Saccharomyces cerevisiae* Ty1 retrotransposon. *Yeast* **22**, 441-55 (2005).
- Takeda, S., Sugimoto, K., Otsuki, H., Hirochika, H. Transcriptional activation of the tobacco retrotransposon *Tto1* by wounding and methyl jasmonate. *Plant Mol Biol.* **36** 365-76 (1998).
- Kashkush K., Feldman, M., Levy, A.A. Gene loss, silencing and activation in a newly synthesized wheat allotetraploid. *Genetics* **160**, 1651-1659 (2002).
- Miyao, A., Iwasaki, Y., Kitano, H., Itoh, J.I., Maekawa, M., Murata, K., Yatou, O., Nagato, Y., Hirochika, H. A large-scale collection of phenotypic data describing an insertional mutant population to facilitate functional analysis of rice genes. *Plant Mol Biol.* **63**, 625-635 (2007).

18. Kalendar, R., Grob, T., Regina, M., Suoniemi, A., Schulman, A. IRAP and REMAP: two new retrotransposon-based DNA fingerprinting techniques. *Theor Appl Genet* **98**, 704-711 (1999).
19. Staden, R., Beal, K.F., Bonfield, J.K. The Staden Package. In: Misener S., Krawetz. *Computer Methods in Molecular Biology. Bioinformatics Methods and Protocols* **132**, 115-130 (1998).
20. Thompson, J.D., Gibson, T.J., Plewniak, F., Jeanmougin, F., Higgins, D.G. The CLUSTAL_X windows interface: flexible strategies for multiple sequence alignment aided by quality analysis tools. *Nucleic Acids Res.* **25** 4876-4882 (1997).
21. Kumar, S., Tamura, K., Nei, M. MEGA3: Integrated software for Molecular Evolutionary Genetics Analysis and sequence alignment. *Briefings in Bioinformatics* **5**, 150-163 (2004).
22. Fávero A.P., Nass, L.L., Cargnin, A., Neto, E.L. Rooting performance from leaf petioles of accessions and hybrids of wild *Arachis* species. *Sci. Agric. (Piracicaba, Braz.)* **62**, 62-68 (2005).
23. Maluszynska, J., Heslop-Harrison, J.S. Physical mapping of rDNA loci in *Brassica* species. *Genome* **36**, 774-781 (1993).
24. Schwarzscher, T., Heslop-Harrison, J.S. *Practical in situ Hybridization*. Springer-Verlag, New York (2000).
25. Altschul, S.F., Gish, W., Miller, W., Myers, E.W., Lipman, D.J. Basic local alignment search tool. *J. Mol. Biol.* **215**, 403-410 (1990).
26. Guimarães, P.M., Garsmeur, O., Proite K., Leal-Bertioli, S.C., Seijo, G., Chaine, C., Bertioli, D., D'hont, A. BAC libraries construction from the ancestral diploid genomes of the allotetraploid cultivated peanut. *BMC Plant Biol.* **29**, 8-14 (2008).
27. Temsch, E.M., Greilhuber, J. Genome size variation in *Arachis hypogaea* and *A. monticola* re-evaluated. *Genome* **43** 449-451 (2000).
28. Temsch, E.M., Greilhuber, J. Genome size in *Arachis duranensis*: a critical study. *Genome* **44**, 826-830 (2001).
29. Gerlach, W.L., Dyer, T.A. Sequence organization of the repeating units in the nucleus of wheat, which contains 5S rRNA genes. *Nucleic Acids Res* **8**, 4851-4865 (1980).
30. Heslop-Harrison, J.S. *et al.* The chromosomal distributions of *Ty1*-copia group retrotransposable elements in higher plants and their implications for genome evolution. *Genetica* **100**, 197-204 (1997).
31. The Arabidopsis Genome Initiative, Sequence and analysis of chromosome 5 of the plant *Arabidopsis thaliana*. *Nature* **408**, 423-426 (2000).
32. Hirochika, H. Contribution of the *Tos17* retrotransposon to rice functional genomics. *Curr. Opin. Plant Biol.* **4**, 118-122 (2001).

Characterization of Resistance Gene Analogs in *Musa acuminata* Cultivars Contrasting in Resistance to Biotic Stresses

F L Emediato, F A C Nunes, C de Camargo Teixeira, M A N Passos, D J Bertoli, G J Pappas Jr & R N G Miller*

Abstract

The majority of commercial banana cultivars (*Musa* sp.) have evolved via asexual vegetative propagation, with diversity dependent upon somatic mutation. Restricted variation has resulted in a crops with little resistance to pests and disease, and conventional breeding efforts are limited due to limited viable seed production. Numerous disease resistance genes (R-genes / R-proteins) have been characterized in plants, recognizing and conferring resistance to bacteria, virus, fungi and nematodes. The identification and cloning of R-genes in *Musa* would contribute to germplasm improvement. To date, five main R-gene classes have been identified, based upon protein domains, with the most abundant coding for nucleotide-binding site-leucine-rich repeat (NBS-LRR) proteins. Primers designed from conserved protein motifs have enabled amplification of NBS homologues across diverse plant species. In *Musa*, our group has identified over 50 distinct NBS-LRR type resistance gene analogs (RGAs) in the resistant wild diploid *M. acuminata* Calcutta 4. The aim of this work was to characterize RGAs in *M. acuminata* cultivars contrasting in resistance to Black leaf Streak Disease. PCR amplification was conducted using DNA from *M. acuminata* cultivars Calcutta 4 (resistant) and Pisang Berlin (susceptible). Degenerate primers targeted sequences homologous to the NBS-LRR R-gene family. Following sequencing and processing of cloned PCR products, 63 out of a total of 136 high quality sequences showed homology to R-genes or RGAs. Phylogenetic analysis was conducted on deduced amino-acid sequences. Degenerate primers were also developed targeting an R-gene family of cytoplasmic serine-threonine (Ser/Thr) receptor-like kinases (RLKs) with extracellular LRRs, for application across cultivars. Studies are also planned for selection and full length sequencing of clones from *M. acuminata* and *M. balbisiana* BAC libraries containing novel RGAs characterized in this study, as an approach for complete R-gene sequence characterization, applicable both in transformation and breeding programs for banana genetic improvement.

Introduction

Banana cultivars have evolved from diploid, triploid and tetraploid wild Asian species of *Musa acuminata* (A genome) and *Musa balbisiana* (B genome). Wild species are generally seminiferous, whilst the majority of commercial cultivars grown today are sterile triploids, with fruit development via parthenocarpy. As these have evolved via asexual vegetative propagation, the genetic base is narrow, with diversity dependent upon somatic mutation. Such restricted variation has resulted in a crop with little resistance to pests and disease. Current breeding for resistance generally relies upon crosses between improved resistant hybrid diploids and commercial triploids, as well as evaluation of tetraploids [1]. Conventional breeding in *Musa* diploids and triploids is, however, hampered due to low numbers or a complete absence of seeds, caused by either a lack of viable pollen, or inefficient pollinating insects.

Post-graduate program in Genomic Sciences and Biotechnology, Universidade Católica de Brasília, Brasília, DF, Brazil; Departamento de Biologia Celular, Universidade de Brasília, Brasília, Brazil

* Corresponding author. E-mail: rmiller@pos.ucb.br

Resistant plant genotypes prevent pathogen entry as non-host plants, or via activation of defense mechanisms following pathogen recognition by resistance genes (R-genes / R-proteins), leading to responses such as the hypersensitive response, synthesis of antimicrobials, cell wall thickening, and vessel blockage. Over the last 15 years, over 40 R-genes have been characterized from both model plants and important crop species [2], conferring resistance to bacteria, virus, fungi and nematodes. The identification and cloning of R-genes in the *Musa* genome would contribute significantly to the future improvement of banana germplasm. To date, five R-gene classes have been identified in plants, based upon conserved protein domains. The most abundant class is the cytoplasmic nucleotide-binding site-leucine-rich repeat (NBS-LRR) proteins. Other classes comprise proteins with extracytoplasmic LRRs (eLRRs) anchored to a transmembrane (TM) domain (receptor-like proteins [RLPs]), cytoplasmic serine-threonine (Ser/Thr) receptor-like kinases (RLKs) with extracellular LRRs, cytoplasmic Ser/Thr kinases without LRRs, and proteins with a membrane anchor fused to a coiled coil (CC) domain. The common NBS-LRR-encoding proteins currently include over 20 proven R-genes from diverse plant species. Primers designed from conserved motifs have also been used to amplify NBS homologues from numerous different plant species (for review see [3]). In the case of *Musa*, our group has identified over 50 distinct NBS-LRR type resistance gene analogs in the resistant wild diploid *M. acuminata* Calcutta 4 [4].

The objective of this work was to continue characterization of RGAs in *M. acuminata* cultivars contrasting in resistance to Black Leaf Streak Disease (BLSD), caused by the ascomycete *Mycosphaerella fijiensis*. Additional degenerate primers were also designed, targeting R-gene cytoplasmic serine-threonine (Ser/Thr) receptor-like kinases (RLKs) with extracellular LRRs, for application across cultivars.

Materials and Methods

DNA extraction

Genomic DNA was extracted from *M. acuminata* cultivars Calcutta 4 (resistant to BLSD) and Pisang Berlin (susceptible to BLSD), using a standard CTAB approach [5], with 200mg of young leaf tissue macerated on a Bio 101 Thermo Savant FastPrep® FP 120 cell disrupter (Qbiogene, Irvine, CA, USA).

PCR amplification

Degenerate Primers: Two degenerate primers were tested for amplification of RGAs in the *Musa* cultivars. These were previously designed in a study by our group from conserved motifs in non-TIR NBS-LRR domain-containing monocotyledon sequences, with proven efficiency in amplification of RGAs in *M. acuminata* Calcutta 4 [4] (**Table 1**).

PCR amplification

PCR reactions were performed in 25 µl volumes, containing 50 ng of genomic DNA, 2.5 mM MgCl₂, 0.2 mM dNTPs, 0.5 µM of each primer, 1.25 U of Platinum Taq polymerase (Invitrogen, Brazil), and 1X Taq polymerase buffer (Invitrogen, Brazil). Amplification was conducted

with the following temperature cycling program: 96°C for 5 min; 35 cycles of 96°C for 1 min, 45°C for 1 min, and 72°C for 1 min; plus an extra elongation period of 10 min at 72°C.

Cloning and sequencing

Following electrophoresis, PCR products of expected size were purified using a Qiagen QIAquick PCR purification kit (Qiagen, Valencia, CA, USA). Products were cloned using pGEM-T-Easy (Promega, Madison, WI, USA). Ligations were desalted using Millipore dialysis membranes (0.02 µM) and DH5α *Escherichia coli* cells were transformed by electroporation using a GenePulser II (Bio-Rad, Hercules, CA, USA) at 2.5 kV and 200Ω. Plasmid DNA was extracted from recombinant clones by a standard alkaline lysis procedure [6]. Single pass sequencing of clones was conducted on ABI 377 sequencer (Applied Biosystems, Foster City, CA, USA), using a DYEnamic ET Terminator Cycle Sequencing Kit (Amersham Biosciences, Piscataway, NJ, USA).

Sequence analysis

Vector and poor quality sequences were removed using the Staden sequence analysis software package [6]. Contig assembly was performed using CAP3 [7]. RGAs were identified based upon sequence similarity using BLASTX [8], against a local database of *A. thaliana* R-genes and homologues, as described in [9]. Derived protein sequence alignments were obtained using the program MUSCLE [10] and included representative non-TIR NBS-LRR sequences from *A. thaliana* and *O. sativa*. Phylogenetic inference was performed using the program Mega v.4.1 [11], via maximum parsimony with 500 bootstrapping replicates.

Degenerate primer design for cytoplasmic serine-threonine (Ser/Thr) receptor-like kinases (RLKs) with extracellular LRRs

Degenerate primers were designed using an *in silico* protocol described by [4]. The process began with HMMER-based selection of sequences from GenBank containing the characteristic domain shared by this class of R-genes, visualized using the Conserved Domain Database, v2.14. Sequences were aligned in MUSCLE [10], and after redundant sequence removal (95% identity threshold), five subgroups were arranged, based upon similarity level using the program CLUSS [12]. All conserved motifs identified served as candidates for degenerate primer design, conducted using the program CODEHOP [13].

Results and Discussion

NBS-LRR RGA isolation

The primer combination applied in this study (3F2–13R1) consistently amplified products of approximately 650 bp in size in both cultivars Calcutta 4 and Pisang Berlin. A total of 136 high quality sequences were generated from insert-containing recombinant plasmids for these two cultivars, of which 63 showed significant similarity to known *A. thaliana* R-genes and homologues (E-value $\leq 10^{-5}$), based upon searches using the BLASTX program. All *Musa* RGAs conformed to the non-TIR NBS class, with a final tryptophan residue in the kinase 2 motif, as expected, given their apparent absence in monocotyledonous genomes [14].

Table 1. Degenerate primer sequences and target motifs used for RGA isolation in *M. acuminata* cultivars

Degenerate Primer	Target motif name / plant origin	Primer sequence (5' to 3') ^a	Author
3F2 (forward)	Kinase 2 / monocotyledon	GAGGTACTTCTGGTGCgagayrtrbtgg	[4]
13R1 (reverse)	LRR / monocotyledon	CGGCCAAGTCGTGCAyavkrtrctrgca	[4]

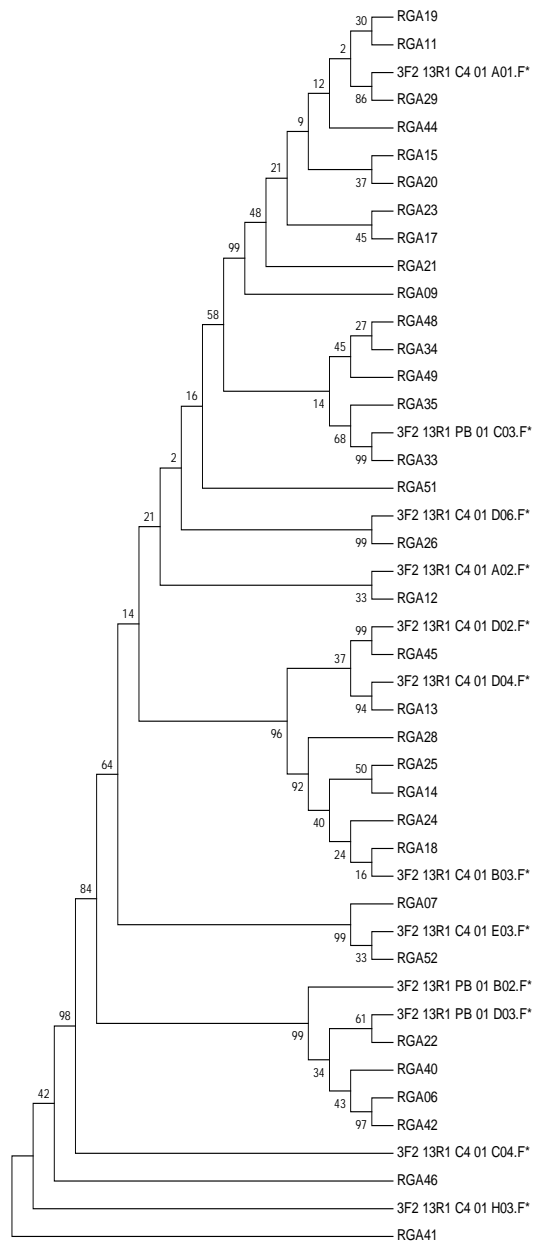

Figure 1 Phylogenetic analysis of common aligned amino acid sequences of 45 *Musa* contig sequences. (* sequences amplified in the current study)

Analysis of assembled RGA sequences

Assembly of the sequences amplified from *M. acuminata* Calcutta 4 and Pisang Berlin generated a total of 18 contigs and singletons with homology to RGAs (46%). Many showed uninterrupted open reading frames (ORFs) encoding RGAs, with the remainder containing premature stop codons, and/or frameshifts. These latter sequences are likely derived from pseudogenes, PCR mutants or artefacts. Analysis of contigs and singletons with homology to R-genes or RGAs revealed nine specific to Calcutta 4, and four to Pisang Berlin. Five contigs contained sequences from both cultivars.

Phylogenetic analysis

A phylogenetic analysis of common aligned amino acid sequences was conducted on 45 *Musa* contig sequences, which included 33 RGA contig sequences previously amplified in Calcutta 4 using eight NBS-LRR-targeting primer combinations [4] (Figure 1). *Musa* sequences were

divergent, indicating the presence of a diverse gene family coding for proteins with NBS-LRR domains. Although potentially dependent upon sample size, clades did not appear to be cultivar specific.

Continued work is underway with the primers targeting additional R-gene families, and on further cultivars contrasting in resistance to BLS. *Musa* RGAs have previously been used by our group for selection of clones from *M. acuminata* Calcutta 4 (AA), *M. acuminata* Grande Naine (AAA), and *M. balbisiana* Pisang Klutuk Wulung (PKW) (BB) BAC libraries [4]. Such studies are also planned with the additional RGAs characterized in this study. Full length sequencing of BAC clones offers potential for identification of complete R-gene nucleotide sequences, applicable both in transformation and breeding programs for banana genetic improvement.

ACKNOWLEDGEMENTS

This work was supported by the IAEA (project 13187/R0), FINEP (01.07.0609.00, referencia 0842/07), CNPq (Projects 680.398/01-5 and 506165/2004-3), and the Universidade Católica de Brasília.

BIBLIOGRAPHY

- Silva, S. de O. *et al.* Banana breeding program at Embrapa. *Crop Breeding and Applied Biotechnology* **1**, 399-436 (2001).
- Martin, G.B. *et al.* Understanding the functions of plant disease resistance proteins. *Annu. Rev. Plant Biol.* **54**, 23-61 (2003).
- Chelkowski, J., Koczyk, G. Resistance gene analogues of *Arabidopsis thaliana*: recognition by structure. *J. Appl. Genet.* **44** 311-321 (2003).
- Miller, R.N.G. *et al.* Analysis of non-TIR NBS-LRR resistance gene analogs in *Musa acuminata* Colla: Isolation, RFLP marker development, and physical mapping. *BMC Plant Biol* **8**, 15 (2008).
- Rogers, S.O. *et al.* Extraction of DNA from plant tissues. In: Gelvin S, Schilperoot RA (eds). *Plant molecular biology manual*. Kluwer Academic Press, Boston, p.A6:1-10 (1988).
- Staden, R. The Staden sequence analysis package. *Mol. Biotechnol.* **5**, 233-241 (1996).
- Huang, X., Madan, A. CAP3: a DNA sequence assembly program. *Genome Res.* **9**, (1999) 868-877.
- Altschul, S.F. *et al.* Gapped BLAST and PSI-BLAST: a new generation of protein database search programs. *Nucleic Acids Res.* **25**, 3389-3402 (1997).
- Bertioli, D.J. *et al.* A large scale analysis of resistance gene homologues in *Arachis*. *Mol. Genet. Genomics* **270**, 34-45 (2003).
- Edgar, R.C. MUSCLE: multiple sequence alignment with high accuracy and high throughput. *Nucleic Acids Res.* **32**, 1792-1797 (2004).
- Tamura, K. *et al.* MEGA4: Molecular Evolutionary Genetics Analysis (MEGA) software version 4.0. *Mol Biol Evolution* **24**, 1596-1599 (2007).
- Abdellali, K. *et al.* CLUSS: Clustering of protein sequences based on a new similarity measure. *BMC Bioinformatics* **8**, 286 (2007).
- Rose, T.M. *et al.* Consensus-degenerate hybrid oligonucleotide primers for amplification of distantly related sequences. *Nucleic Acids Res.* **26** 1628-1635 (1998).
- Meyers, B.C. *et al.* TIR-X and TIR-NBS proteins: two new families related to disease resistance TIR-NBS-LRR proteins encoded in *Arabidopsis* and other plant genomes. *Plant J.* **32**, 77-92 (2002).
- Sambrook, J., Russell, D.W. *Molecular Cloning*. 3rd ed. Cold Spring Harbor Press, Cold Spring Harbor, New York (2001).

Enhancing Drought and Salinity Tolerance in Wheat Crop Grown in the Mediterranean Region

K Masmoudi*, F Brini, K Feki, M Hanin, A Nouri-Khemakhem & H Khoudi

Abstract

Drought and salinity are major constraints on crop production and food security, and adversely affect entire countries over several years resulting in serious social, economic, and environmental costs. Water is in an extremely short supply in up to 10 eastern and southern Mediterranean countries. Wheat production in the Mediterranean region is limited mainly by the availability of water resources. Investigating the mechanisms by which wheat physiologically adapts to water deficits points to a salinity tolerance strategy showed that varieties of wheat which are able to maintain photosynthesis and growth at low soil Ψ_w often display a relatively greater capacity for leaf osmotic adjustment. Understanding the molecular basis of salt-stress signaling and tolerance mechanisms in wheat is required for engineering local wheat genotypes more tolerant to salt stress. This goal can be achieved only by first deciphering the physiological responses of wheat to salt stress. Recent work at the molecular level has led to the identification and cloning of cDNAs encoding proteins which are involved in the cellular-level physiological system which facilitates this adaptive response. Transgenic *Arabidopsis* plants over-expressing wheat candidate genes encoding ion transport proteins (TNHX1, SOS1, TVP1), or dehydrin (DHN-5) are much more resistant to high concentrations of NaCl and to water deprivation than the wild-type strains. Over-expression of the isolated genes from wheat in *Arabidopsis thaliana* plants is worthwhile to elucidate the contribution of these proteins in the tolerance mechanism to salt and drought. Testing candidate genes in TILLING available wheat population will allow the identification of new alleles conferring abiotic stress tolerance.

Introduction

Wheat production in the Mediterranean region is limited mainly by the availability of water resources and soil salinity. This problem is more acute when irrigation procedures use poor quality water and when soil drainage is poor. This has led to serious loss of yields in many arid and semi-arid regions in the World. Plants have developed different strategies to face water deficit and over the past few years, much attention has been focused on the identification of genes and proteins induced in response to environmental stress [1, 2]. Developing embryos have been largely used as an experimental model to study desiccation tolerance, due to their ability to survive extreme water loss during the final maturation stage of development. Some of the polypeptides accumulating in the mature embryos are directly involved in dehydration tolerance and in many cases, similar polypeptides have been shown to accumulate both in dry embryos and in vegetative tissues of plants subjected to stresses such as dehydration, cold, high salinity and abscisic acid (ABA) treatments [3, 4].

In wheat, one of the major mechanisms conferring salt tolerance is sodium exclusion from the leaves [5, 6, 7]. Sodium exclusion is achieved by means of low net uptake by cells in the root cortex and tight control

of net unloading of the xylem by parenchyma cells in the stele [8, 9]. The enhanced K^+/Na^+ discrimination trait in bread wheat (*Triticum aestivum*, AABBDD) cultivars confers some degree of salt tolerance [10]. A locus for the trait, *kna1*, was mapped to the distal region of chromosome 4DL [11]. In contrast, tetraploid durum wheat (*Triticum turgidum* L. subsp. *Durum*, AABB) cultivars which are more salt-sensitive than bread wheat [12, 13], lack this trait. A homologue of the *kna1* locus has not yet been found on either the A or B genomes of tetraploid wheat. Genetic analysis of Na^+ exclusion in *durum* wheat showed that, in a low leaf blade Na^+ phenotype, Na^+ exclusion was controlled by two dominant loci that are interactive (epistatic) rather than additive [14]. These loci were designated *Nax1* and *Nax2* (Na^+ exclusion loci). Recently, a molecular marker linked to *Nax1* was identified and has facilitated the rapid transfer of this trait into commercial varieties of *durum* wheat [15]. Physiological studies indicated that in a tolerant genotype, the control leaf blade Na^+ concentration is the result of the interaction between net xylem loading and leaf sheath sequestration [16]. Species that cannot exclude salt from the transpiration stream must also be able to compartmentalize the salt in vacuoles, thereby protecting the cytoplasm from ion toxicity and avoiding build-up of rigid cell wall, which would cause dehydration [17]. If Na^+ is sequestered in the vacuole of the cell, K^+ and organic solutes should accumulate in the cytoplasm and organelles to balance the osmotic pressure of the Na^+ in the vacuole. Na^+ sequestration into the vacuole depends on expression and activity of Na^+/H^+ antiporters as well as on V-type H^+ -ATPases and H^+ -PPases. These phosphatases generate the necessary proton gradient required for activity of Na^+/H^+ antiporters and homeostasis equilibrium. Furthermore, sodium efflux from root cells prevents accumulation of toxic levels of Na^+ in the cytosol and transport of Na^+ to the shoot. Molecular genetic analyses in *Arabidopsis* *sos* mutants have led to the identification of a plasma membranes Na^+/H^+ antiporter, SOS1, which plays a crucial role in sodium efflux from root epidermal cells and the long distance Na^+ transport from root to shoot under salinity [18]. Studies of the physiological response of wheat to drought and salt stress are very important to understand the molecular bases on gene expression. The aim of this study was to determine the physiological correlates of the genetic control of leaf Na^+ in durum wheat to facilitate screening for novel traits and to enhance understanding the mechanism of saline tolerance in the two wheat genotypes. Expression patterns of candidate genes, *TmHKT1*; *4-A2*, *TNHX1* and *SOS1* was studied in roots, sheaths and leaves of the two wheat genotypes to determine traits for improving control of Na^+ uptake and transport. As salinity stress negatively affects survival, growth, and development of crop plants, owing to irrigation practices and increasing demands on fresh water supply, engineering of salt-tolerant crop plants could provide an acceptable solution to the reclamation of farmlands lost to agriculture because of salinity and lack of rainfall. In this study, it is shown that transgenic *Arabidopsis thaliana* plants over-expressing one of the two wheat cDNAs encoding the tonoplast H^+ -PPase (TVP1) or the Na^+/H^+ antiporter (TNHX1) are much more resistant to high concentrations of NaCl and to water deprivation than the isogenic wild-type strains. These

Plant Molecular Genetics Laboratory, Center of Biotechnology of Sfax (CBS), Sfax-Tunisia.

* Corresponding author. E-mail: khaled.masmoudi@cbs.rnrt.tn

transgenic plants accumulate more Na⁺ and K⁺ in their leaf tissue than the wild type.

Materials and Methods

Plant material and stress conditions

Two Tunisian cultivars of Durum wheat (*Triticum durum* Desf.), Mahmoudi (salt-sensitive) and Om Rabia3 (salt-tolerant), were selected for their behavior during saline conditions and used throughout this study. Seedlings from each line were cultured in plastic pots and watered with half-strength modified Hoagland solution by hydroponics system. Plants were grown until the third leaf stage and then we applied salt stress. NaCl doses (0, 50, 100, and 200mM) were progressively applied (salt treatment was adjusted with increasing NaCl concentrations by 50mM per day).

RNA extraction and RT-PCR

Total RNA was extracted from 200 mg of young leaves of Arabidopsis transgenic lines using the RNeasy total RNA isolation kit (Qiagen). To remove contaminating DNA, RNA was treated with RNase-free DNase (Promega). DNase-treated RNAsamples were reverse transcribed using MMLV reverse transcriptase (Invitrogen).

Generation of transgenic Arabidopsis plants

The full length TNHX1, TVP1, and Dhn-5 open reading frames (ORFs) were amplified with Pfu Turbo DNA polymerase (Stratagene, La Jolla, CA, USA) using wheat cDNA library as template and primers corresponding to the 5' and 3' ends of the wheat candidate genes. The TNHX1 and TVP1 ORF were cloned separately into the BamHI and EcoRI sites of the pCB302.2 plasmid [20]. This binary vector contains a tandem repeat of the cauliflower mosaic virus (CaMV) 35S promoter, the 35S terminator, and the BAR gene for resistance to the herbicide Basta as a selectable marker, between the NOS promoter and terminator. The Dhn-5 ORF was cloned into the NcoI site of the pCambia1302 plasmid resulting in a fusion with GFP (DHN-5::GFP). This vector contains the hygromycin resistance gene (HPT) as a selectable marker, between the 35S promoter and terminator. *Agrobacterium*-mediated transformation was performed via the floral dipping technique of *Arabidopsis thaliana* (ecotype Columbia) [21].

Results

Ion status

Measurement of Na⁺ accumulation over 21 days indicated two major differences in Na⁺ transport between Om Rabia3 and Mahmoudi. Om Rabia3 genotype sequestered more Na⁺ in leaf sheaths than salt sensitive Mahmoudi did when grown in 100 mM NaCl. In contrast, in the leaf blades, Mahmoudi accumulated more Na⁺ than Om Rabia3, while the roots of both genotypes accumulated Na⁺ to similar concentration (Fig. 1). Storage of Na⁺ in the leaf sheaths was investigated further by measuring Na⁺ content of the leaf sheath and leaf blade after one week of exposure to different levels of NaCl. Although the two genotypes accumulated Na⁺ to different concentrations in the leaf sheath, salt tolerant Om Rabia3 accumulated a substantially higher Na⁺ concentration than Mahmoudi with no evidence of saturation of storage. The two genotypes seem to have a contrasting capacity to store Na⁺ in the leaf sheath and their leaf sheath cells may differ in their ability to extract Na⁺ from the xylem stream. This possibility was supported by genotypic differences in the proportion of total leaf Na⁺ content that was stored in the leaf sheath. Om Rabia3 sequestered up to 70 % of total leaf Na⁺ in the leaf sheath, and this capacity appeared to reach saturation since a slight decrease was observed at 200mM NaCl. In contrast, salt sensitive Mahmoudi stored only up to 40% of leaf Na⁺ in the sheath, with little change in response to external NaCl levels. To investigate whether the preferential accumula-

tion of Na⁺ in leaf sheaths in Om Rabia3 represented a general solute accumulation mechanism, we measured K⁺ in the leaf blade and leaf sheath of both genotypes during 21 d growth in 100mM NaCl. K⁺ was accumulated to similar levels in the leaf sheath of each cultivar, whereas in leaf blades, more K⁺ accumulated in Om Rabia3 than Mahmoudi giving a higher K⁺/Na⁺ ratio in the salt tolerant cultivar.

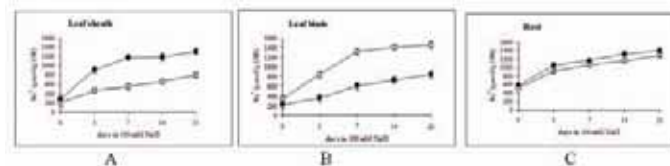

Figure 1 Increase in Na⁺ concentrations in the leaf sheaths (A), leaf blades (B) and roots (C), of salt tolerant Om Rabia3 (closed symbols) and salt sensitive Mahmoudi (open symbols) during 21 d growth in 100mM NaCl.

Sodium uptake and transport in the plant

Many genes are important in maintaining K⁺ or Na⁺ homeostasis in higher plants, and could be considered candidates for genetic manipulation. We have studied the expression levels of three candidate genes implicated in improving the control of Na⁺ uptake, transport and sequestration: *TmHKT1;4-A2* (*Triticum monococcum* putative sodium transporter; accession number: EF062819 [22]); *TNHX1* (*Triticum aestivum* Na⁺/H⁺ antiporter; Accession Number: AY296910 [23]); *SOS1* (*Triticum aestivum* plasma membrane Na⁺/H⁺ antiporter; Accession Number: AY326952 [24]) in *T. monococcum* and the two Tunisian durum wheat varieties: Mahmoudi and Om Rabia3 exposed to 100mM NaCl during two days (Fig. 2).

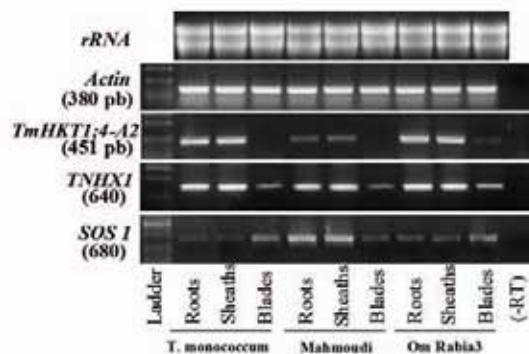

Figure 2 Expression levels of *TmHKT1;4-A2*, *TNHX1* and *SOS1* in roots, sheaths and blades of *T. monococcum*, *T.durum* CVs Mahmoudi and Om Rabia3 using specific gene primers.

Using gene specific primers for RT-PCR analysis, *TmHKT1; 4-A2* was detected highly in roots and leaf sheath of *T. monococcum* and Om Rabia3 and slightly in Mahmoudi, whereas, it was not expressed in leaf blades, consistent with the physiological role of *Nax1* in reducing the Na⁺ concentration in blades by retaining Na⁺ in the sheaths [25]. The expression levels of *TNHX-1* were almost the same in the root and leaf sheath of the three genotypes, however in the leaf blade, there was a high accumulation of *TNHX-1* in Om Rabia3 compared to *T.monococcum* and Mahmoudi. For *SOS1*, which is a plasma membrane Na⁺/H⁺ antiporter, there is a high accumulation of transcript in the root and leaf sheath of Mahmoudi compared to *T.monococcum* and Om Rabia3. *SOS1* and *TmHKT1; 4-A2* could be expressed in an opposite manner when plants are subjected to salt stress.

Molecular characterization of transgenic *Arabidopsis* lines over-expressing the wheat candidate genes (*Dhn-5*, *TNHX1*, and *TVP1*)

All transgenic *Arabidopsis* lines expressed the *Dhn-5*, *TNHX1* and *TVP1* genes (Fig. 3A). Southern blot of genomic DNA of the transgenic lines shows different integration patterns confirming that all lines were derived from independent transformation events (Fig. 3B).

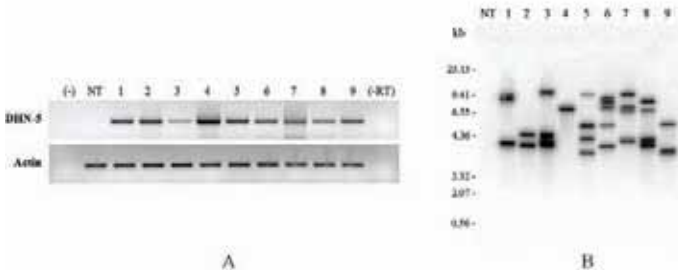

Figure 3 Analysis of the transgenic *Arabidopsis* lines. (A) Analysis by RT-PCR of *Dhn-5* expression in *Arabidopsis* transgenic lines. (B) Southern blot analysis of genomic DNA of R1 transformants.

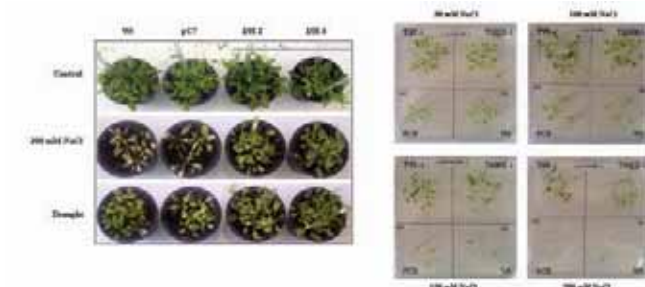

Figure 4 Effect of stress conditions on *in vivo* and *in vitro* cultured *TNHX1*, *TVP1*, and *Dhn-5* transgenic *Arabidopsis* plants. (A) Effect of stress conditions in soil cultured *Dhn-5* transgenic *Arabidopsis* plants. The photograph corresponds to plants at day 10 of water deficit stress and to plants after three days of continuous salt treatment (200mM NaCl). (B) *Arabidopsis* plants grown in standard culture medium during one week (the first two true leaves have already emerged) were transferred to culture plates containing 50mM, 100mM, 150mM or 200mM NaCl. The photograph was taken 10 days after transplantation, when the transgenic salt-stressed seedlings showed a higher survival rate compared to control.

Increased tolerance of stress treatments of transgenic plants

The observed improvement of tolerance to mannitol in the transgenic *Dhn-5* lines is simply displayed by a better capacity to resume growth after osmotic stress caused by the mannitol treatment. When plants grown on soil were subjected to salt stress (200mM) and drought (10 days of water deprivation), a clear difference was also observed between transgenic and control plants. After 10 days of stress treatments (salt or drought), the DH-2 and DH-4 lines continued to grow, albeit at a slower rate, whereas control plants exhibited chlorosis and died (Fig. 4A). The homozygous transgenic lines *TNHX1* and *TVP1* were tested for salt and drought-stress tolerance. Ten days after germination, *Arabidopsis* seedlings were transferred to MS medium containing 50–200mM NaCl, and plant survival was monitored. The transgenic plants over-expressing *TNHX1* and *TVP1* are much more salt tolerant than wild-type or transgenic plants transformed with empty plasmid (Fig. 4B). Plants from *TNHX1* and *TVP1* transgenic lines continue to grow well in the presence of 100–200mM NaCl, whereas wild-type plants and the empty plasmid transgenic line (pCB) exhibit chlorosis and die after 10 days of salt-stress treatment. The toxic effects of 150mM NaCl, with inhibition of growth and development of chlorotic leaves after 10 days in control plants, were delayed and attenuated in the transgenic plants. In plants grown on soil under salt stress (200mM NaCl) or drought (10 days of

water deprivation), controls showed growth reduction and exhibited chlorosis, whereas the transgenic lines survived and continued normal growth.

Discussion

Over-expression of the wheat vacuolar Na^+/H^+ antiporter *TNHX1* and H^+ -pyrophosphatase *TVP1* in transgenic *Arabidopsis* plants results in salt and drought tolerance. Wild-type plants displayed progressive chlorosis, reduced leaf area, and a general growth inhibition when treated with high salt concentrations or when deprived from watering. The transgenic plants accumulate more Na^+ and K^+ in their leaf tissue. The increased accumulation of Na^+ and K^+ is likely to be a consequence of the activity of the vacuolar Na^+/H^+ antiporter. We speculate that the antiporter facilitates K^+ as well as Na^+ uptake into vacuoles in exchange for H^+ into the cytoplasm. This compartmentalization may prevent Na^+ toxicity and facilitate cellular K^+ uptake [26]. The Na^+/H^+ antiporter of *Arabidopsis thaliana* (*AtNHX1*) was shown to mediate the transport of K^+ as well as Na^+ in tomato tonoplast vesicles [27]. The capacity of *AtNHX1* to mediate both K^+/H^+ and Na^+/H^+ transport was also demonstrated on reconstituted liposomes with purified *AtNHX1* [28]. Moreover, vacuoles isolated from leaves of the *Arabidopsis nhx1* mutant plants had much lower Na^+/H^+ and K^+/H^+ exchange activity [29]. Alternatively, the increase in K^+ content of leaves in the transgenic lines (*TNHX1* and *TVP1*) may also result from increased Na^+ compartmentalization in leaf cells leading to increased transpiration rates and therefore increased delivery of K^+ to the leaves [30]. The over-expression of the wheat Na^+/H^+ antiporter and H^+ -PPase genes in crop plants, including wheat, may be one strategy to engineer agriculturally important plants to withstand these important abiotic stresses. The over-expression of *DHN-5* in *Arabidopsis* has also resulted in an improved tolerance to water stress [31]. However, the resistance to high concentrations of LiCl was not affected in these lines. This finding suggests that the observed tolerance due to *DHN-5* depends on an osmotic rather than an ionic tolerance mechanism. This seems to be confirmed by a higher accumulation in the transgenic lines of proline, an osmolyte that is known to contribute to osmotic adjustment. The major aim of our research is an immediate production of transgenic local and regional crop varieties of wheat by ectopic expression of the already proven salt and drought tolerance genes (*TNHX1*, *TVP1*, and *DHN5*). The rationale for improving abiotic stress tolerance in the crop cultivars grown in the Mediterranean countries by over-expressing genes that were shown to confer improved salt and drought tolerance in other plants offers a first-rate possibility to transfer these traits into local crop varieties. We already have taken a Tunisian patent on methods of regeneration and genetic transformation of durum wheat genotypes adapted to the Mediterranean conditions [32]. Callus induction and regeneration of whole plants are already optimized for one Tunisian durum wheat variety. The durum wheat varieties indigenous to the Mediterranean countries are relatively high-yielding in good environmental conditions but do not perform well under drought or in saline soils. Selected varieties representative to the Mediterranean countries are being transformed with either biolistic or *Agrobacterium tumefaciens*.

BIBLIOGRAPHY

1. Zhu, J.K. Salt and drought stress signal transduction in plants. *Annu. Rev. Plant Biol.* **53**, 247–273 (2002).
2. Bray E. Plant responses to water deficit. *Trends Plant Sci.* **2**, 48–54 (1997).
3. Gomez, J. Sanchez Martinez D., Stiefel V., Rigau J., Puigdomènech P., Pagès M., A gene induced by the plant hormone abscisic acid in response to water stress encodes a glycine-rich protein. *Nature* **334**, 262–264 (1988).
4. Mundy, J., Chua, N.H. Abscisic acid and water stress induce the expression of a novel rice gene. *EMBO J.* **7**, 2279–2286 (1988).

5. Shah, S.H., Gorham J., Forster B.P., Wyn Jones, R.G. Salt tolerance in the triticeae: the contribution of the D-genome to cation selectivity in hexaploid wheat. *J Exp Bot* **38**, 254-269 (1987).
6. Gorham, J., Wyn Jones, R.G., Bristol, A. Partial characterization of the trait for enhanced K⁺-Na⁺ discrimination in the D genome of wheat. *Planta* **180**, 590-597 (1990).
7. Husain, S., Munns, R., Condon, A.G. Effect of sodium exclusion trait on chlorophyll retention and growth of durum wheat in saline soil. *Aust J Agric Res*. **54**, 589-597 (2003).
8. Tester, M., Davenport, R. Na⁺ tolerance and Na⁺ transport in higher plants. *Ann Bot* **91**, 503-527 (2003).
9. Munns, R., James, R.A., Läuchli, A. Approaches to increasing the salt tolerance of wheat and other cereals. *J Exp Bot* **57**(5), 1025-1043 (2006).
10. Dvorák, J., Noamam, M.M., Goyal, S., Gorham, J. Enhancement of the salt tolerance of *Triticum turgidum* L. by the *Kna1* locus transferred from the *Triticum aestivum* L. chromosome 4D by homoeologous recombination. *Theor Appl Genet*. **87**, 872-877 (1994).
11. Dubcovsky, J., Santa Maria, G., Epstein, E., Luo, M.C., Dvorák, J. Mapping of the K⁺/Na⁺ discrimination locus *Kna1* in wheat. *Theor Appl Genet* **2**, 448-454 (1996).
12. Rawson, H.M., Richards, R.A., Munns, R. An examination of selection criteria for salt-tolerance in wheat, barley and triticale genotypes. *Australian Journal of Agricultural Research* **39**, 759-772 (1988b).
13. Gorham, J., Wyn Jones, R.G., Bristol, A. Partial characterization of the trait for enhanced K⁺-Na⁺ discrimination in the D genome of wheat. *Planta* **180**, 590-597 (1990).
14. Munns, R., Rebetzke, G.J., Husain, S., James, R.A., Hare, R.A. Genetic control of sodium exclusion in durum wheat. *Aust J Agric Res*. **54**, 627-635 (2003).
15. Lindsay, M.P., Lagudah, E.S., Hare, R.A., Munns, R. A locus for sodium exclusion (*Nax1*) a trait for salt tolerance, mapped in durum wheat. *Funct Plant Biol*. **31**, 1105-1114 (2004).
16. Davenport, R., James, R.A., Zakrisson-Plogander, A., Tester, M., Munns, R. Control of sodium transport in durum wheat. *Plant Physiol* **137**, 807-818 (2005).
17. Flowers, T.J., Yeo, A.R. Ion relations of plants under drought and salinity. *Austral J Plant Physiol* **13**, 75-91 (1986).
18. Shi, H., Quintero, F.J., Pardo, J.M., Zhu, J.K. The putative plasma membrane Na⁺/H⁺ antiporter SOS1 controls long-distance Na⁺ transport in plants. *Plant cell* **14**, 465-477 (2002).
19. Kobayashi, N., Horikoshi, T., Katsuyama, H., Takashi, H., Takayanagi, K. A simple and efficient DNA extraction method for plants, especially woody plants. *Plant Tissue Cult Biotechnol* **4**, 76-80 (1998).
20. Xiang, C., Han, P., Lutziger, I., Wang, K., Oliver, D.J. A mini binary vector series for plant transformation. *Plant Mol Biol* **40**, 711-717 (1999).
21. Clough, S.J., Bent, A.F. Floral dip: a simplified method for *Agrobacterium*-mediated transformation of *Arabidopsis thaliana*. *Plant J* **16**, 735-743 (1998).
22. Huang, S.H., Spielmeyer, W., Lagudah, E.S., James, R., Platten, D.J., Dennis, E.S., Munns, R. A sodium transporter (HKT7) is a candidate for *Nax1*, a gene for salt tolerance in durum wheat. *Plant Physiol* **142**(6), 1718-1727 (2006).
23. Brini, F., Gaxiola, R., Berkowitz, G., Masmoudi, K. Cloning and characterization of a wheat vacuolar cation/proton antiporter and pyrophosphatase proton pump. *Plant Physiol Biochem* **43**, 347-354 (2005).
24. Xu, H., Jiang, X., Zhan, K., Cheng, X., Chen, X., Pardo, J.M., Cui, D. Functional characterization of a wheat plasma membrane Na⁺/H⁺ antiporter in yeast. *Arch Biochem Biophys* **473**, 8-15 (2008).
25. James, R.A., Davenport, R., Munns, R. Physiological characterisation of two genes for Na⁺ exclusion in wheat: *Nax1* and *Nax2*. *Plant Physiol* **142**, 1537-1547 (2006).
26. Wu, S.J., Ding, L., Zhu, J.K. SOS1, a genetic locus essential for salt tolerance and potassium acquisition. *The Plant Cell* **8**, 617-627 (1996).
27. Zhang, H.X., Blumwald, E. Transgenic salt-tolerant tomato plants accumulate salt in foliage but not in fruit. *Nature Biotechnol* **19**, 765-768 (2001).
28. Venema, K., Quintero, F.J., Pardo, J.M., Donaire, J.P. The *Arabidopsis* Na⁺/H⁺ exchanger *AtNHX1* catalyzes low affinity Na⁺ and K⁺ transport in reconstituted liposomes. *J Biol Chem* **277**, 2413-2418 (2002).
29. Apse, M.P., Sottosanto, J.B., Blumwald, E. Vacuolar cation/H⁺ exchange, ion homeostasis, and leaf development are altered in a T-DNA insertional mutant of *AtNHX1*, the *Arabidopsis* vacuolar Na⁺/H⁺ antiporter. *Plant J* **36**, 229-239 (2003).
30. Brini, F., Hanin, M., Mezghanni, I., Berkowitz, G., Masmoudi, K. Overexpression of wheat Na⁺/H⁺ antiporter *TNHX1* and H⁺-pyrophosphatase *TVPI* improve salt and drought stress tolerance in *Arabidopsis thaliana* plants. *J Exp Bot* **58**(2), 301-308 (2007).
31. Brini, F., Hanin, M., Lumbreras, V., Amara, I., Khoudi, H., Hassairi, A., Pagès, M., Masmoudi, K. Overexpression of wheat dehydrin DHN-5 enhances tolerance to salt and osmotic stress in *Arabidopsis thaliana*. *Plant Cell Rep*. **26**, 2017-2026 (2007).
32. Khoudi, H., Nouri-Khemakhem, A., Sayar, R., Brini, F., Masmoudi, K. Methods of regeneration and genetic transformation of durum wheat genotypes adapted to North Africa and Middle East conditions. INNORPI. Patent N° SN07060 (2007).

Cyto-palynological, Biochemical and Molecular Characterization of Original and Induced Mutants of Garden Chrysanthemum

S K Datta^{1*}, K Datta² & J Chatterjee³

Abstract

A large number of new somatic flower color/type mutants have been evolved by induced mutations in different ornamental plants. Few reports are available on the systematic work being done on the comparative analysis of the original and mutant cultivars. This paper reports the result of comparative analysis on cyto-palynological, biochemical and molecular characters of original and mutant cultivars for a better understanding of the exact mechanism involved in the origin and evolution of flower color mutations. Cultivar identification and cultivar relatedness are important issues for horticultural breeders. Proper characterization and identification of new mutant cultivars is extremely important to protect plant breeder's rights for commercial exploitation.

Introduction

A large number of new flower color/type and chlorophyll variegated mutant varieties have been developed worldwide and commercialized [1-4]. Induced mutagenesis in chrysanthemum is the most successful story. Mutants are phenotypically different from parental variety only in flower color/shape and leaf variegation. There are different opinions regarding the origin of these somatic mutations. Chromosomal aberrations, changes in chromosome number, gene mutation, rearrangement of different histogenic layers and mutation occurring in the biochemical pathway leading to pigment formation are the probable explanations for radiation induced flower color changes. Based on these interpretations, the exact mechanism of induction of somatic flower color mutations cannot be explained with certainty. It is often difficult to distinguish the mutants having a common progenitor or between progenitors. This paper reports results of comparative cyto-palynological, anatomical, biochemical and DNA-based fingerprinting of original and mutant cultivars for a better clear understanding of the exact mechanism(s) involved in the origin and evolution of somatic flower color mutation.

Materials and Methods

Plant materials

Original and Gamma-ray induced mutant cultivars of garden chrysanthemum (*Chrysanthemum morifolium* Ramat.), developed at National Botanical Research Institute, Lucknow, India, were selected as materials for the present analysis.

Cytological preparations

Root tips were collected and temporary squash preparations were made for cytological studies (chromosome counting, chromosomal behavior, karyotype) after staining in Feulgen following the usual hydrolysis procedure [5].

Micromorphology

Flower petals were fixed and then mounted on SEM stubs using double-sided adhesive tape after critical point drying. Subsequently, the materials were sputter coated with gold (200 Å thickness) and scanning photomicrographs were taken in JEOL-JSM 35C Scanning Electron Microscope at 10 kV [6].

Pollen morphology

Pollen grains were collected soon after anthesis and pollen slides were made for the study of pollen sterility, size and ornamentations both under light microscope and SEM [7].

Phenolic compounds

Florets were extracted in methanol containing 1% HCl. Chromatograms were developed on glass plates coated with silica gel emulsion. The plates were run in suitable solvent and R_f values of each spot were calculated [8].

DNA extraction and PCR analysis for RAPD analysis

Genomic DNA was extracted from very young leaves by using the DNA extraction procedure in [9]. A total of 40 random primers (Bangalore Genei, India) were tested. Similarity coefficient was calculated [10]. A dendrogram of hierarchical classification was made using the software SPSS 10.0. Pair-wise comparison was done for all genotypes using unweighed pair-group cluster analysis method using arithmetic means [11].

Results and Discussion

Cytological studies

The somatic chromosome number in all the mutant and original cultivars was found to be the same i.e. $2n=(6x)=54$, except in parent cv. 'Ratna' and its mutant 'Sonali', where the chromosome number was $54+2$. Few cells with chromosomal aberrations like bridge (Fig. 1), fragment, laggard, early separation, clumping, exclusion, micronucleus, etc., were detected during root tip mitosis. Percentage of cells with such aberrations varied from 03 – 2.4%. No mutant specific abnormality could be detected.

The chromosomes of all the materials were characterized on the basis of centromere location and nature and position of secondary constrictions.

¹ 4/184, Vivek Khand, Gomti Nagar, Lucknow 226010, India. Present address : CSIR, Emeritus Scientist, Madhyamgram Experimental Farm, Acharya J. C. Bose Biotechnology Innovation Center, Bose Institute, Jessore Road, Madhyamgram, 24-Parganas (N), Kolkata 700129, India.

² Palynology Laboratory, National Botanical Research Institute, Lucknow 226001, U.P., India

³ Bose Institute, P-1/12, CIT Scheme VIIM, Kolkata – 700 054, India

* Corresponding author. E-mail : subodhskdatta@rediffmail.com; subodhskdatta@yahoo.com

tion. Comparison of ideograms showed that the mutants did not differ from their respective original cultivars in number of types of chromosomes and number of each type represented in them. The karyotype in the analyzed original and mutant cultivars was reasonably symmetrical [5].

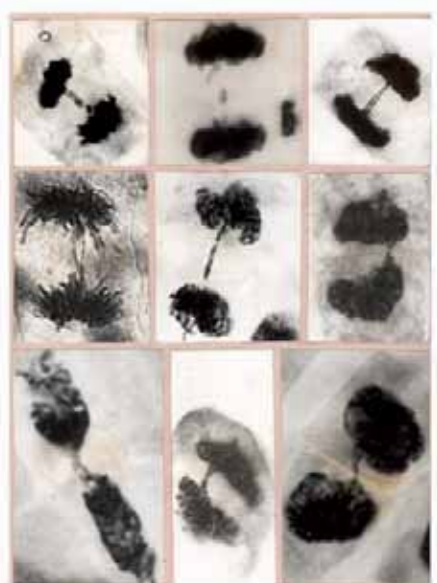

Figure 1 Chromosomal aberrations during root tip mitosis : bridges.

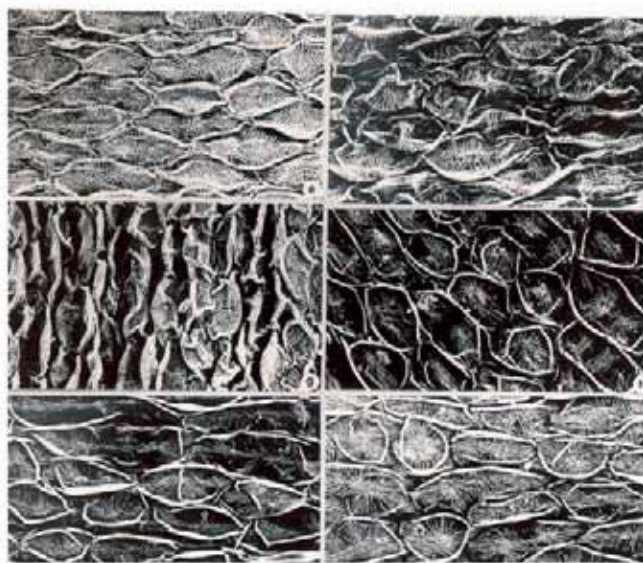

Figure 2 SEM photographs of petal surface of original and mutants of chrysanthemum.

Micromorphological studies

The study on petal epidermal micromorphology reveals considerable variation, particularly in cell boundaries, cell surface, striations and papillae between the original and their respective induced mutant cultivars. It indicated that flower color changes due to mutation were also associated with some changed micromorphology of petal surface (Fig. 2). This study clearly indicates that the petal micromorphological characters can be utilized not only for identifying mutants, but also that

a correlation study will help the proper identification of chrysanthemum and their origin [6].

Palynological studies

Pollen grains of most of the chrysanthemum cultivars were regular in size, but few cultivars and their mutants had dimorphic pollen grains (Fig. 3). The shape of endocolpium was variable; lalongate type was most common but lolongate, circular, square, and indiscernible types were also found. Variation in the shape of endocolpium in the pollen mass was also encountered. Conspicuous changes in exine surface pattern have been observed. The shape of exine spines was variable with regard to base and tip. The exine surface of the original cv. 'D-5' having a fosso-reticulate pattern with narrow muri and irregularly shaped lumina, changed to reticulate exine with broad muri and uniformly circular lumina in the mutants 'Alankar' and 'Agnisikha'. The tips of the spines also changed from straight to bent. The reticulate undulated exine surface of the original cv. 'Kingsform Smith' changed to a scrobiculate wrinkled surface in the mutant cv. 'Rohit'. The punctata exine surface pattern of the original cv. 'Himani' transformed to a scrobiculate pattern in the mutant cv. 'Sheela' [7].

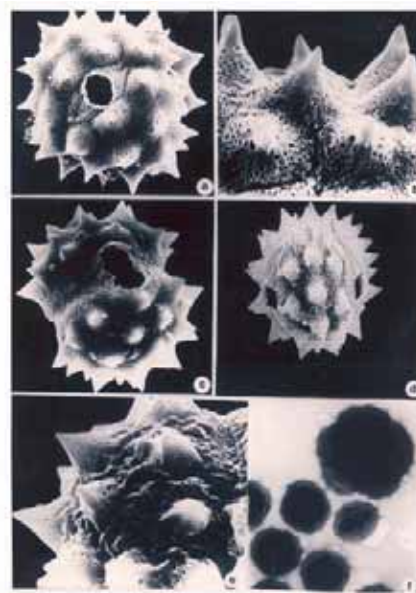

Figure 3 SEM photographs of pollen grains of original and mutant cvs. of chrysanthemum.

Pigment analysis

Pigments of florets/petals of large number of chrysanthemum and rose mutants and original cultivars have been studied by thin layer chromatographic and spectrophotometric methods (Fig. 4). Such analyses indicated that somatic flower color changes were due to both qualitative and/or quantitative changes in pigments as a result of mutation/s induced by Gamma-rays in pigment biosynthesis pathway. A schematic representation has been suggested, which explains the probable manner in which differences in chromatographic pattern of pigments of original and mutant cultivars may arise [2, 8, 12-14].

RAPD analysis

Out of 40 primers used for RAPD analysis, 10 gave better profiles. Some yielded extremely different banding patterns in mutants and parents.

Bands generated by RAPD fragments were of low molecular weight ranging from 400 bp to 1,500 bp. Bands for each primer ranged from three to 13. This showed a monomorphic banding pattern in all the materials except 'Manbhawan,' where it showed one additional polymorphic band of 550 bp, which made it identifiable from its mother plant 'Flirt' and also from 'Batik,' another mutant of 'Flirt.' Only two primers, i.e. P2 and P3, were able to distinguish some of the mutants from their parents. The similarity among the cultivars and mutants varied from 0.17 to 90% (Fig. 5). A low genetic similarity among the mutants and their parents was quite acceptable, as the mutants did not vary greatly in their morphology. A large similarity index would indicate genetically similar backgrounds, while a small similarity index would indicate distantly related backgrounds, and this may explain the wide range of indices (0.17-0.90) found between mutant cultivars and their parents. Although they differed in flower color, bands specific for color could not be distinguished, due to the resolution capacity of tested primers. It is however possible that some of the specific bands present for some of the mutants may code for flower color, but this can only be verified by using SCAR markers and cloning cDN [15].

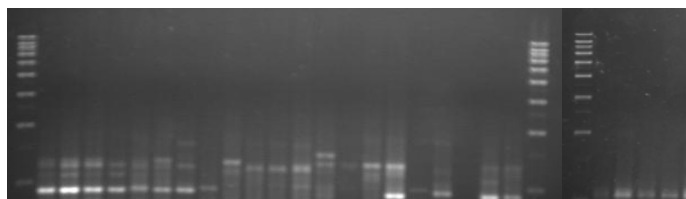

Figure 4 Chromatogram of original chrysanthemum cv. 'E-13' (extreme left) and its five mutants.



Figure 5 RAPD profile of original and mutant cvs. of chrysanthemum.

Cytological analyses clearly indicated that changes in flower color may be considered to have taken place through gene mutation, but neither through change in chromosome number and aberration nor due to change in karyomorphology. Pollen grain analysis indicated that no appreciable change in pollen apertural character took place in the mutants. Significant changes in pollen exine surface pattern occurred in some of the mutants. These changes were inconsistent and not dose (Gamma-ray) specific. It may be concluded that the changes due to

mutation were perhaps induced at several independent loci controlling different characters and that the loci are differentially sensitive to mutagenic treatment. Mutants with different flower color could be identified at the molecular level using RAPD technique holding promise to identify unique genes as SCAR markers. A high genetic distance among the different chrysanthemum showed that a possibility exists of introgressing new and novel genes from the chrysanthemum gene pool [15].

ACKNOWLEDGEMENT

Thanks are due to the Director, NBRI, Lucknow, India for providing the facilities. Authors thankfully acknowledge Department of Biotechnology, Ministry of Science and Technology, Government of India for financial assistance of the project. Dr. S.K.Datta thanks the Director, Bose Institute, Kolkata and CSIR, New Delhi for his present association with the institute as CSIR, Emeritus Scientist.

BIBLIOGRAPHY

- Datta, S.K. Chrysanthemum cultivars evolved by induced mutation at National Botanical research Institute, Lucknow, India, *Chrysanthemum* **49**, 72-75 (1988).
- Datta, S.K. Mutation studies on garden chrysanthemum – A review, *Scientific Horticulture* **7**, 159-199 (2001).
- Ahloowalia, B.S. *et al.* Global impact of mutation-derived varieties. *Euphytica* **135**, 187-204 (2004).
- Broertjes, C., Van Harten, A.M. Applied mutation breeding for vegetatively propagated crops, Elsevier, Amsterdam (1988).
- Datta, S.K. Cytological interpretations in garden chrysanthemum. In : Plant Cytogenetics in India (ed. Sibdas Ghosh), Association for Cell and Chromosome Research, Dept. of Botany, Calcutta University, Calcutta, 107-114 (1994).
- Datta, S.K., Shome, U. Micromorphological studies of original and mutant cultivars of ornamentals. *Feddes Repertorium* **3-4**, 167-174 (1994).
- Datta, K., Datta, S.K. Palynological interpretation of gamma ray and colchicines induced mutation in Chrysanthemum cultivars. *Israel. Journal of Plant Sciences* **46**, 199-207 (1998).
- Datta, S.K., Gupta, M.N. Cytomorphological, palynological and biochemical studies on control and gamma ray induced mutant of chrysanthemum cultivar 'D-5', *The Chrysanthemum* **37**, 193-200 (1981).
- Saghai-Marouf, M.A. *et al.* Ribosomal DNA spacer-length polymorphism in barley : Mendelian inheritance, chromosomal location, and population dynamics. *Proc. Natl. Acad. Sci.* **81**, 8014-8018 (1984).
- Nei, M., Li, W.H. Mathematical model for studying genetic variation in terms of restriction endonuclease, *Proc. Natl. Acad. Sci. U.S.A.* **76**, 5269-5273 (1979).
- Sneath, P.H.A., Sokal, R.R. Numerical taxonomy, Freeman Publications, San Francisco, USA (1973).
- Datta, S.K. Thin layer chromatographic studies and evolution of somatic mutations in rose, *The Indian Rose Annual V*, 41-48 (1986).
- Datta, S.K. New chrysanthemum cultivars and their spectrophotometric and TLC studies. *Sci. and Cult.* **52**, 205-206 (1986).
- Datta, S.K. Induced changes of phenolic compounds in mutants. *New Botanist* **14**, 17-19 (1987).
- Chatterjee, J. *et al.* Molecular systematics in Chrysanthemum x grandiflorum (Ramat.) Kitamura. *Scientia Horticulturae* **110**, 373-378 (2006).

Analysis of EMS Mutagenized Soybean by Combination of DOP-PCR and GS-FLX

K Van^{1*}, M Y Kim¹, T-H Jun¹ & S-H Lee^{1,2}

Abstract

Ethylmethanesulfonate (EMS) has been commonly used to induce mutations for various organisms because it led to irreversible mutations with a high level of frequency. With relatively few individuals, saturated mutagenized populations could be generated by chemical mutagens. Since high-throughput sequencing instruments, such as GS-20 or GS-FLX from Roche/454 Life Sciences are now available, characterization of nucleic acids and massive mutant analysis are more feasible. Due to the requirement of sequence information and high cost for designing primers, degenerate oligonucleotide primed PCR (DOP-PCR) instead of direct sequencing was used for single nucleotide polymorphisms (SNPs) survey. In this study, we screen point mutation in soybean mutants generated by EMS mutagenesis using a combination of DOP-PCR methodology and GS-FLX. Four different modified DOP-PCR primers were used for amplifying genomic DNA of three soybean genotypes, Sinpaldalkong 2, SS2-2 and 25-1-1. Then, nucleotide sequences of these amplified PCR products were analyzed by GS-FLX. Different number and length of contigs and singlets were constructed depending on soybean genotypes and nucleotide identity, after sequences were trimmed and aligned. With 100% in identity, average 1,100 contigs and 7,000 singlets were formed in each soybean genotype. In order to survey sequence polymorphisms, POLYBAYES was used with base quality consideration. A total of 1,187 putative SNPs were detected, and these polymorphisms should be reconfirmed by direct sequencing after a homology search against GenBank databases.

Introduction

Inducing mutations is a major factor for studying genetics [1], and using chemical mutagens is the most common and popular method to induce mutations [2]. Alkylating agents, such as EMS, were commonly used to induce mutations for various organisms by formation of adducts with nucleotides, causing nucleotides to miss-pair with their complementary bases [3-7]. Additionally, only low levels of chromosome breaks resulted from EMS mutagenesis. Thus, chemical mutagenesis has become the best method for inducing mutations in genetic studies [2].

Chemical mutagens make it difficult to position mutated sites. Instead of using chemical mutagens, different transgenic technologies, such as tagging or precise targeting, were developed and commonly used in reverse genetics [2]. Simple PCR-based detection for screening mutations is one of the advantages for inducing mutations by new transgenic technologies because changes of amplified fragment size after mutagenesis can be easily identified [4]. But chemical mutagenesis became a popular method for inducing mutations after SNP detection technologies [8] for reverse-genetic mutational screening were rapidly developed.

Saturated mutagenized populations could be generated by chemical mutagens with relatively few individuals [4]. Also, these chemical mutagens are used in reverse genetics like TILLING (Targeting Induced Local Lesion in Genomics) [9-11]. High-throughput technologies were developed for detection of single nucleotide polymorphisms (SNPs) because large numbers of mutated individuals were generated in TILLING [4]. Direct sequencing combined automated polymorphism discovery programs is the original method for SNP discovery [11-14]. Denaturing high-pressure liquid chromatography (DHPLC) [15-17] and CEL1 endonuclease cleavage followed by polyacrylamide gel electrophoresis analysis [2, 18] are also commonly used for SNP survey as the non-sequencing strategies.

Due to the requirement of sequence information and high cost for designing primers, DOP-PCR instead of direct sequencing was used for SNPs survey [19]. Since high-throughput sequencing instruments, such as GS-20 or GS-FLX from Roche/454 Life Sciences are now available, characterization of nucleic acids and massive mutant analysis are more feasible [20-23].

In this study, we screen point mutation in soybean mutants generated by EMS mutagenesis using a combination of DOP-PCR methodology and GS-FLX.

Materials and Methods

Four different modified DOP-PCR primers were used for amplifying genomic DNA of three soybean genotypes, Sinpaldalkong 2 (recommended cultivar in Korea) [24], SS2-2 (EMS induced mutant from Sinpaldalkong 2 [25] and 25-1-1 (M_3 regenerated plant from EMS-treated immature embryo cultures of Sinpaldalkong 2). Genomic DNA from three soybean genotypes were isolated by [13] and DOP-PCR was performed as described by [19]. Then nucleotide sequences of these amplified PCR products were analyzed by GS-FLX.

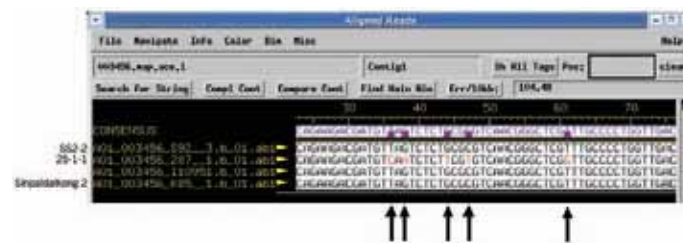

Figure 1 A portion of aligned GS-FLX sequences of soybean genotypes. Putative SNPs are indicated by arrows.

Results and Discussion

Modified DOP-PCR primers were trimmed by custom PERL scripts and the TGICL tool was used for alignment and assembly [26]. Different number and length of contigs and singlets were constructed depending on soybean genotypes and nucleotide identity (98% or 100%), after

¹ Department of Plant Science and Research Institute for Agriculture and Life Sciences, Seoul National University, Seoul, 151-921, Korea

² Plant Genomics and Breeding Institute, Seoul National University, Seoul, 151-921, Korea

* Corresponding author. E-mail: kvan@snu.ac.kr

sequences were trimmed and aligned (Table 1). At 98% in identity, more than 1,400 contigs and 4,300 singlets were formed in each soybean genotype. The numbers of contigs and singlets were increased in 100% of identity; average 1,100 contigs and 7,000 singlets (Table 1).

In order to survey sequence polymorphisms, only orthologues showing 100% of identity were used to avoid possible inclusion of paralogous sequences. A total of 1,187 putative SNPs were identified by POLYBAYES with base quality consideration (Fig. 1). These polymorphisms will be further analyzed by direct sequencing or DHPLC after homology searches are performed against GenBank databases.

Table 1. Numbers of contigs and singlets and their lengths after sequence alignments by nucleotide identities

Soybean genotypes	Identity	Contigs		Singlets		Total	
		Number	Length (bp)	Number	Length (bp)	Number	Length (bp)
Sinpaldalkong 2	98%	1,649	356,933	5,101	695,133	6,750	1,052,066
	100%	1,150	249,989	7,722	1,144,077	8,872	1,394,066
SS2-2	98%	1,460	235,296	5,211	520,144	6,671	755,440
	100%	1,130	176,262	7,085	775,004	8,215	951,266
25-1-1	98%	1,433	304,703	4,387	561,251	5,830	865,954
	100%	1,038	215,282	6,447	910,336	7,485	1,125,618

BIBLIOGRAPHY

- Muller, H.J. Types of visible variation induced by X-rays in *Drosophila*. *J. Genet.* **22**, 299-334 (1930).
- Greene, E.A., Codomo, C.A., Taylor, N.E., Henikoff, J.G., Till, B.J., Reynolds, S.H., Enns, L.C., Burtner, C., Johnson, J.E., Odden, A.R., Comai, L., Henikoff, S. Spectrum of chemically induced mutations from a large-scale reverse-genetic screen in *Arabidopsis*. *Genet.* **164**, 731-740 (2003).
- Haughn, G., Somerville, C.R. Selection of herbicide resistance at the whole-plant level," Application of Biotechnology to Agricultural Chemistry (Lebaron, H.M., Mumma, R.O., Honeycutt, R.C., Duesing, J.H., Eds.), American Chemical Society, Easton, PA, 98-107 (1987).
- Henikoff, S., Comai, L. Single-nucleotide mutations for plant functional genomics. *Annu. Rev. Plant Biol.* **54**, 375-401 (2003).
- Koornneef, M., Dellaert, L.W., Van Der Veen, J.H., EMS-and radiation-induced mutation frequencies at individual loci in *Arabidopsis thaliana*. (L.) Heynh. *Mutat. Res.* **93**, 109-123 (1982).
- Goll, M.G., Bestor, T.H. Histone modification and replacement in chromatin activation. *Genes Dev.* **16**, 1739-1742 (2002).
- Zhu, B.G., Gu, A.Q., Deng, X.D., Geng, Y.Z., Lu, Z.X. Effects of caffeine or EDTA post-treatment on EMS mutagenesis in soybean. *Mutat. Res.* **334**, 157-159 (1995).
- Kwok, P.Y. Methods for genotyping single nucleotide polymorphisms. *Annu. Rev. Genomics Hum. Genet.* **2**, 235-258 (2001).
- Mccallum, C.M., Comai, L., Greene, E.A., Henikoff, S. Targeted screening for induced mutations. *Nat. Biotechnol.* **18**, 455-457 (2000).
- Bentley, A., MacLennan, B., Calvo, J., Dearolf, C.R. Targeted recovery of mutations in *Drosophila*. *Genetics* **156**, 1169-1173 (2000).
- Wienholds, E., Schulte-Merker, S., Walderich, B., Plasterk, R.H. Target-selected inactivation of the zebrafish *rag1* gene. *Science* **297**, 99-102 (2002).
- Kanazin, V., Talbert, H., See, D., Decamp, P., Nevo, E., Blake, T. Discovery and assay of single-nucleotide polymorphisms in barley (*Hordeum vulgare*). *Plant Mol. Biol.* **48**, 529-537 (2002).
- Van, K., Hwang, E.-Y., Kim, M.Y., Kim, Y.H., Cho, Y.-I., Cregan, P.B., Lee, S.-H. Discovery of single nucleotide polymorphisms in soybean using primers designed from ESTs. *Euphytica* **139**, 147-157 (2004).
- Nickerson, D.A., Tobe, V.O., Taylor, S.L. PolyPhred: automating the detection and genotyping of single nucleotide substitutions using fluorescence-based resequencing. *Nucleic Acids Res.* **25**, 2745-2751 (1997).
- McCallum, C.M., Comai, L., Greene, E.A., Henikoff, S. Targeted screening for induced mutations. *Nat. Biotechnol.* **18**, 455-457 (2000).
- Underhill, P.A., Jin, L., Lin, A.A., Mehdi, S.Q., Jenkins, T., Vollrath, D., Davis, R.W., Cavalli-Sforza, L.L., Oefner, P.J. Detection of numerous Y chromosome biallelic polymorphisms by denaturing high-performance liquid chromatography. *Genome Res.* **7**, 996-1005 (1997).
- Wolford, J.K., Blunt, D., Ballecer, C., Prochazka, M. High-throughput SNP detection by using DNA pooling and denaturing high performance liquid chromatography (DHPLC). *Hum. Genet.* **10**, 483-487 (2000).
- Colbert, T., Till, B.J., Tompa, R., Reynolds, S., Steine, M.N., Yeung, A.T., McCallum, C.M., Comai, L., Henikoff, S. High-throughput screening for induced point mutations. *Plant Physiol.* **126**, 480-484 (2001).
- Janiak, A., Kim, M.Y., Van, K., Lee, S.-H. Application of degenerate oligonucleotide primed PCR (DOP-PCR) for SNP discovery in soybean. *Euphytica* **162** 249-256 (2008).
- Margulies, M., Egholm, M., Altman, W.E., Attiya, S., Bader, J.S., Bemben, L.A., Berka, J., Braverman, M.S., Chen, Y.-J., Chen, Z., Dewell, S.B., Du, L., Fierro, J.M., Gomes, X.V., Godwin, B.C., He, W., Helgesen, S., Ho, C.H., Irzyk, G.P., Jando, S.C., Alenquer, M.L.I., Jarvie, T.P., Jirage, K.B., Kim, J.-B., Knight, J.R., Lanza, J.R., Leamon, J.H., Lefkowitz, S.M., Lei, M., Li, J., Lohman, K.L., Lu, H., Makhiyani, V.B., McDade, K.E., McKenna, M.P., Myers, E.W., Nickerson, E., Nobile, J.R., Plant, R., Puc, B.P., Ronan, M.T., Roth, G.T., Sarkis, G.J., Simons, J.F., Simpson, J.W., Srinivasan, M., Tartaro, K.R., Tomasz, A., Vogt, K.A., Volkmer, G.A., Wang, S.H., Wang, Y., Weiner, M.P., Yu, P., Begley, R.F., Rothberg, J.M. Genome sequencing in microfabricated high-density picolitre reactors. *Nature* **437**, 376-380 (2005).
- Bennett, S.T., Barnes, C., Cox, A., Davies, L., Brown, C. Toward the 1,000 dollars human genome. *Pharmacogenomics* **6**, 373-382 (2005).
- Parameswaran, P., Jalili, R., Tao, L., Shokralla, S., Gharizadeh, B., Ronaghi, M., Fire, A.Z. A pyrosequencing-tailored nucleotide barcode design unveils opportunities for large-scale sample multiplexing. *Nucleic Acids Res.* **35**, 130 (2007).
- Schuster, S.C. Next-generation sequencing transforms today's biology. *Nature Methods* **5**, 16-18 (2008).
- Kim, S.D., Hong, E.H., Song, Y.G., Kim, Y.H., Lee, Y.H., Hwang, Y.H., Kim, H.S., Lee, S.H., Kim, W.H., Ryu, Y.H., Park, R.K. New soybean variety resistant to disease and lodging, with adapted high yielding "Sinpaldalkong 2". *RDA J. Agric. Sci.* **36**, 153-157 (1994).
- Lee, H.S., Chae, Y.A., Park, E.H., Kim, Y.W., Yun, K.I., Lee, S.H. Introduction, development, and characterization of supernodulating mutant. I. Mutagenesis of soybean and selection of supernodulating mutant. *Kor. J. Crop Sci.* **42**, 247-253 (1997).
- Perlea, G., Huang, X., Liang, F., Antonescu, V., Sultana, R., Karamycheva, S., Lee, Y., White, J., Cheung, F., Parvizi, B., Tsai, J., Quackenbush, J. TIGR Gene Indices clustering tools (TGICL): a software system for fast clustering of large EST datasets. *Bioinformatics* **19**, 651-652 (2003).

Improvement of Mutant Wheat for Baking Quality Using Marker-assisted Selection

B Naserian Khiabani*, M J Zamani, M T Hallajian & C Vedadi

Abstract

Cultivars carrying the alleles HMWx2 and HMWx5 were classified according to results of SDS-PAGE in polyacrylamide gel. Based on SDS-PAGE results we made crosses between Bezostaya, Enia, Tajan, Chamran, Pishtaz as pollinators (with high bread making quality) and Tabasi mutant lines (low bread making quality, but with other desirable traits) as recipient parents. F₁ and F₂ plants subsequently obtained from F₁ hybrids were planted in a greenhouse. Selection for high baking quality was performed using an STS marker related to Glu1D (subunits 5+10) that showed a sharp band (450bp) in all genotypes that have 5+10 subunits. The identification of *Glu-D1* HMWx5 carrier genotypes is more straightforward at the gene than at the gene product level. Furthermore, in all blind experiments, including a wide array of wheat genotypes, the PCR system correctly detected the presence of the *Glu-D1* HMWx5+y10 pair. F₂ individuals that had this allele were selected and planted in the field in April 2007. Selection of F₃ individuals was done according to agronomical traits such as earliness, vigor and yield components, such as seed number per spike, weight of seed per spike, etc.

Introduction

Wheat is one of the three most important crops in the world, together with maize and rice. Approximately 600 million tons are harvested annually with cultivation extending over a vast geographical area, including higher elevations in the tropics. Dough of bread wheat (*Triticum aestivum* L., AABBDD, n = 7) has unique properties, the most important of which is the elasticity of its gluten (the product of wheat storage proteins). This special property allows for the baking of bread, which has been a basic food for man throughout recorded history, and probably for a much longer period; it remains the principal food product made from wheat [1]. The physical properties (rheological properties) of wheat-flour doughs include their extensibility and resistance to extension, which in turn have a major influence on their mixing behavior, and are important factors in determining the bread making quality of a wheat variety. Wheat gluten proteins consist of two major fractions: the gliadins and the glutenins [2].

The proteins, called high molecular weight glutenins (HMW-GS), make dough elastic and allow it to trap the gas bubbles produced by yeast and to rise [3]. Moreover, bread-making performance has also been related to the glutenin polymer size distribution. Cultivars of high bread making quality have high proportions of glutenin polymers of high molecular size [4, 5]. Bread-making quality of wheat genotypes is determined by specific alleles of high-molecular weight glutenin subunits (HMW-GS) and can be improved by integration and expression of specific HMW-GS genes. Alleles for HMW glutenins encoded at the Glu-1 loci have been shown to contribute to bread making quality [6, 7, 8, 9]. A strong association with gluten strength was reported in many studies for the 5 + 10 subunit pair encoded at Glu-D1 locus [6,

7]. Different x and y subunit combinations encoded at the Glu-B1 locus have also been reported to have different effects on gluten strength [10].

Although the protein fraction of wheat seed known as gluten is associated with baking quality, High Molecular Weight (HMW) glutenins are the subunits most closely associated with this trait. Bread wheat could in theory, contain six different HMW-GS, but due to the “silencing” of some of these genes, most common wheat cultivars possess three to five HMW-GS. Bread wheat could, in theory, contain six different HMW-GS but due to the “silencing” of some of these genes, these proteins have conserved amino and carboxy domains with Cys residues and a repetitive hydrophobic central domain. The homologous loci *Glu-A*, *Glu-B* and *Glu-D* control the synthesis of HMW glutenins and are found on linkage group 1 of their respective homologous genomes in wheat. Each loci encodes two subunits of different molecular weights, x and y. These subunits present a tight genetic linkage and are frequently reported as the x+y pair. Considering HMW-GS composition, the most frequent subunits at Glu-A1 locus were N, at Glu-B1 locus 7+9 and at Glu-D1 locus 2+12. The cultivars with the GS 5+10 at Glu-D1 locus have shown better technological characteristics in contrast to cultivars with the GS 2+12. Several independent studies report the close association between the allelic pair HMWx5+y10 at the locus *Glu-D1* and improved baking quality, whereas the opposite applies to the allelic pair HMWx2+y12 [11, 12].

The genetic analysis of wheat is hampered by its large genome size (3,500 Mb, being 1 Mb 1,000,000 pairs of bases) and hexaploid nature (there are three genomes: A, B and D in cultivated wheat). Traditional methods to select wheat segregant lines carrying “good” baking quality alleles are based upon sodium dodecyl sulphate-polyacrylamide gel electrophoresis (SDS-PAGE) systems or the rheological analysis of advanced breeding lines. However, according to [13] there are known discrepancies between derived molecular weights and their order of migration on SDS-PAGE for some HMW glutenins. Since even medium size wheat breeding programmes handle over 10,000 genotypes per year, steady and cost-effective systems based on the identification of genes rather than gene products are required. Once such systems are developed and verified they can be easily up-scaled and expanded, taking advantage of Polymerase Chain Reaction (PCR) procedures. Molecular markers were used to identify the allele/gene composition of complex loci *Glu-A1* and *Glu-B1* of high-molecular-weight (HMW) glutenin subunits in triticale cultivars by [9, 10, 11, 12]. Schwarz, *et al* [14] showed that the PCR assay can be applied for the detection and negative selection of the ‘poor bread-making quality’ Glu-B1-1d (B-x6) alleles in wheat breeding programmes. The availability of DNA sequences of a number of HMW glutenin alleles allowed the design of specific PCR primers that could be used to assess the allelic variation at the Glu-1 loci [12].

Bustos, *et al* [15] described the cloning and characterization of the nucleotide sequence belonging to the x-null allele of this gene. Their results showed the usefulness of the method in selecting recombinant plants with desired glutenin alleles using molecular markers at any moment in plants life cycle. Accuracy, simplicity and speed make the proposed PCR

Agriculture, Medicine & Industry Research School, Iran.

* Corresponding author. E-mail: bnaserian@nrcam.org

generated DNA markers a valid alternative to standard techniques for selecting genotypes containing the high-molecular-weight glutenin subunits related to bread quality. Moreover, MAS could allow the screening of hundreds of plants in one day for a quick, early-generation evaluation, thereby saving time and resources otherwise required for seed increase and physical quality testing in a wheat breeding programme [10].

Here, we looked for DNA polymorphisms between the HMW glutenin alleles Glu-1D (5+10 and 2+12). Also, we used this polymorphism in detecting high baking quality amongst F_2 and F_3 individuals.

Materials and Methods

Experiments were conducted in the Molecular Marker Lab of the Nuclear Agriculture Department of the Agriculture Medicine and Industry Research School, Iran, with 49 cultivars/mutant lines selected for this project. These genotypes are 34 mutant lines produced by gamma irradiation of some Iranian cultivars (Tabasi, Roshan, Omid, Azar, Azadi) with 150Gy, 200Gy and 250Gy in 1995 by Majd, *et al*, and 15 commercial cultivars. Cultivars carrying the alleles HMWx2 and HMWx5 were chosen according to results of SDS-PAGE in polyacrylamide gels.

For transferring of 5+10 subunits to mutant lines that did not have good quality, crosses were done between Bezostaya, Enia, Tajan, Chamran, Pishtaz as pollinators (with high bread making quality) and Tabasi mutant lines (low bread making quality) which have desirable traits as recipient parents. F_1 and then F_2 plants derived from F_1 were planted in a greenhouse. Genomic DNA of each individual in the F_2 generation was extracted by mini-CTAB methods from leaves, and was quantified via spectrophotometer measurement of UV absorption at 260 nm and by means of 1.2% agarose gel electrophoresis with ethidium bromide fluorescence, with a 100 bp DNA ladder (SMO321 Fermentas) as DNA size marker. Selection for high baking quality was performed using STS Marker [16] related to Glu1D (subunits 5+10). This primer (5'GCCTAGCAACCTTCACAATC3', 5' GAAACCTGCTGCGGACAAG 3') reproduced a single sharp band (450bp) in all genotypes that have 5+10 subunits. Optimized PCR conditions were 50 ng of DNA; 300 mM each dNTP, 3 mM $MgCl_2$, 10 pmol each primer and 0.6 U *Taq* DNA polymerase (all purchased from MBI Fermentas) in a 25 μ l volume. A Tgradient thermocycler (Biometra) was used and the PCR programme included 25 cycles at 94°C for 1 min; 63°C for 45s and 72°C for 30 s and final extension at 72°C for 5 min (annealing temperature was slightly changed according to Primers). PCR products were soaked at 4°C and separated through electrophoresis. Agarose gels (1.5%) were prepared in 1X TAE buffer and electrophoresis was conducted at 100 V. Gels were then stained with Ethidium Bromide, digitized and stored. All the bands were compared with 100bp ladder (SMO321 Fermentas) as DNA size marker.

Results and Discussion

Individuals were selected according to baking quality using STS markers as well as agronomical traits in the F_3 and F_4 generation under field condition.

Table 1 and Fig. 1 show SDS-PAGE results, where none of the Tabasi mutant lines has 5+10 subunits. Instead of 5+10, all the Tabasi mutant lines have 2+12 subunits. Only some of the commercial cultivars such as Bezostaya, Enia, Tajan, Chamran, Pishtaz, showed 5+10 subunits. Generally, in Iranian wheat, frequency of 2+12 is more than 5+10; the frequency of 2+12 subunits was just over 75%. In contrast, the frequency of 5+10 that was less than 25 % (**Table 2**). In addition, other subunits like 13+16 and 17+18 in gluB1 locus that had positive effect on baking quality were seen in low frequency, so that most of the mutant genotypes had low quality. On the other hand, a commercial cultivar that was used as control had high baking quality. According to [4] and [5], there is a significant relationship between the presence or the absence of some specific high molecular weight (HMW) glutenin subunits and bread

making quality of wheat varieties. The most important subunits are 5+10 and 2+12, which are expressed from the Glu - D1 loci.

Considering HMW-GS composition, the most frequent subunits at Glu-A1 locus were N, at Glu-B1 locus 7+9 and at Glu-D1 locus 2+12. The cultivars with the GS 5+10 at Glu-D1 locus have shown better technological characteristics in contrast to cultivars with the GS 2+12. Several independent studies report the close association between the allelic pair

Table 1. High Molecular Weight (HMW) quality score for some Iranian mutant wheat

NO	Genotype	Glutenin subunit			Score
		1A	1B	1D	
1	ChS	N	7+8	2+12	6
2	Bezostaya	2*	7+9	5+10	9
3	Enia	1	7+8	5+10	10
4	Kraj1	N	7+9	5+10	7
5	Pishtaz	2*	7+8	5+10	10
6	Chamran	2*	7+9	5+10	9
7	Navid	2*	7	5+10	8
8	Atrak	2*	7+9	5+10	9
9	Hot Tajan	2*	17+18	5+10	10
10	Tajan	2*	13+16	5+10	10
11	Tabasi	N	7+8	2+12	6
12	T-65-9-1p	2.1	7+8	2+12	6
13	T-66-58-6	N	7+8	2+12	6
14	T-66-58-9	N	7	2+12	4
15	T-65-6	2.1	7+8	2+12	6
16	T-65-5-1	2.1	7+8	2+12	6
17	T-66-58-10	2.1	7+9	2+12	5
18	T-66-58-12	N	7+9	2+12	5
19	T-65-4	N	7+8	2+12	6
20	T-65-9-1	N	7+9	2+12	5
21	T-67-60	N	7+8	2+12	6
22	T-65-7-1	N	7+8	2+12	6
23	T-66-58-8	2*	13+16	2+12	8
24	T-66-I-II				?
25	T-65-9-II-4	N	17+18,9	2+12	6
26	T-65-58-14	1	6+8	2+12	6
27	T-66-58-7	N	-	2+12	3
28	As-48	2*	6+8	2+12	6
29	Asadi	2*	7+8	2+12	8
30	Azar	2*	7+8	2+12	8
31	Az Mutant	2*	6+8	2+12	6
32	Omid	N	7+8	2+12	6
33	O-64-4	2.1	7+8	2+12	6
34	O-64-1-1	2.1	7+8	2+12	6
35	O-64-1-10	N	6+9	2+12	3
36	Roshan	N	7+8	2+12	6
37	Ro-1	N	7+8	2+12	6
38	Ro-3	N	7+8	2+12	6
39	Ro-6	N	9	2+12	3
40	Ro-9	N	17+18	2+12	6
41	Ro-10	N	6+8	2+12	4
42	Ro-12	N	7+9	2+12	5
43	Ro-11	N	7+8	2+12	6

HMWx5+y10 at the locus *Glu-D1* and improved baking quality, whereas the opposite applies to the allelic pair HMWx2+y12 [11, 12].

Table 2. Frequency (%) of the high molecular weight glutenin subunits (HMW-GS) in wheat cultivars

Locus	Bands	Alleles	Cultivars/mutant lines	% of frequency
Glu-A1	2*	b	12	28.57
	N	c	22	52.39
	1	a	2	4.76
	2.1	d	6	14.28
	7	a	2	4.77
	7+8	b	20	47.61
	7+9	c	8	19.04
Glu-B1	6+8	d	4	9.52
	13+16	f	2	4.76
	17+18	l	3	7.14
Glu-D1	2+10	e	33	78.57
	5+10	d	9	21.43

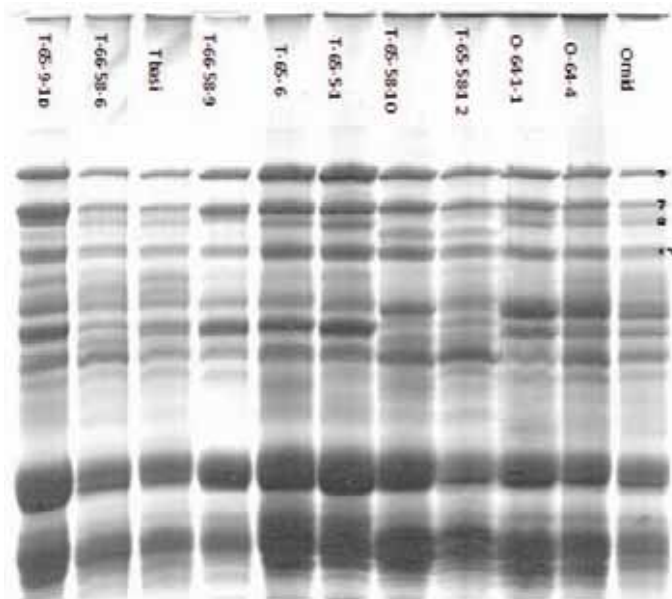

Figure 1 HMW Glutenin electrophoregrams of the wheat (Tabsi mutants and Omid mutants).

P5P6 primer produced a 450 bp (**Fig. 2**) sharp and clear band in genotypes that have DX5 allele. Using this primer, F_2 individuals having 5+10 allele were selected and, in April 2007, were planted in the field, where F_3 individuals were selected according to various agronomic traits, i.e. earliness, vigor, etc., and plants with high performance were selected. These plants will be planted in field conditions. Some F_3 plants showed a new band at 1,350 bp. This band was observed in both the genotypes that showed 450 bp band or not, so that it needs to be sequenced to determine its possible role in baking quality and also to define it for new recombinant alleles. According to [17] and [18], there is a clear genetic association between baking quality and HMW glutenins allelic composition in wheat. Since there are only two main reported alleles in the HMW-D locus, detecting the presence or absence of just one allele allows deducing the allelic composition of any given wheat sample. Traditional methods to select wheat segregated lines carrying “good” baking quality alleles are based upon sodium dodecyl sulphate polyacrylamide gel electrophoresis (SDS-PAGE) systems or the rheological analysis of advanced

breeding lines. The direct use of DNA information is a valuable tool to identify segregating breeding lines useful for plant breeders. The system reported here allows the steady identification of wheat breeding lines carrying HMWx5 alleles.

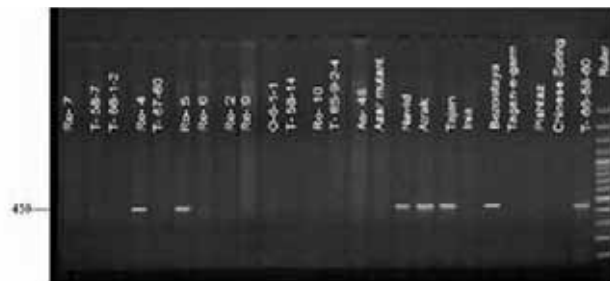

Figure 2 PCR product by P5P6 primer, this primer represent DX5, the genotypes that carrier this subunit produced a 450 band, while other genotypes that have DX2 didn't produce any band.

BIBLIOGRAPHY

- Briggie, L.W., Curtis, B.C. Wheat worldwide. In: E.G. Heyne (Ed.), *Wheat and Wheat Improvement*, p.1–31 (1987).
- Nieto-Taladriz, M.T., Perretant, M.R., Rousset, M. Effect of gliadins and HMW and LMW subunits of glutenin on dough properties in the F_6 recombinant inbred lines from bread wheat cross. *Theor Appl Genet* **88**, 81–88 (1994).
- Cornish, G.B., Bekes, F., Eagles, H.A., Payne, P.I. Prediction of dough properties for bread wheat. In: Wrigley C, Bekes F, Bushuk W, editors. *Gliadin and glutenin—the unique balance of wheat quality*. StPaul, Minn.: American Assn. of Cereal Chemistry (2006).
- Huebbner, F.R., Wall, J.S. Fractionation and quantitative differences of glutenin from wheat varieties varying in baking quantity. *Cereal Chem* **53**, 258–63 (1976).
- Bottomley, R.C., Kearns, H.F., Schofield, J.D. Characterization of wheat flour and gluten proteins using buffers containing sodium dodecyl sulphate. *J Sci Food Agric* **33**, 4481–91 (1982).
- Payne, P.I., Nightingale, M.A., Krattiger, A.F., Holt, L.M. The relationship between HMW glutenin subunit composition and the bread-making quality of British-grown wheat varieties. *J Sci Food Agric* **40**, 51–65 (1987).
- Payne, P.I., L.M. Holt, C.N. Law, 1981. Structural and genetical studies on the high molecular-weight subunits of wheat gluten. Part I: Allelic variation in subunits amongst varieties of wheat (*Triticum aestivum*). *Theor Appl Genet* **60**: 229–239.
- Lukow, O.M., Payne, P.I. Tkachuk, R. The HMW glutenin subunit composition of Canadian wheat cultivars and their association with bread-making quality. *J. Sci. Food Agric.* **46**, 451–460 (1989).
- Ammar, K., Kronstad, W.E., Morris, C.F. Breadmaking quality of selected durum wheat genotypes and its relationship with high molecular weight glutenin subunits allelic variation and gluten protein polymeric composition. *Cereal Chem.* **77**, 230–236 (2000).
- Ahmad, M. Molecular marker-assisted selection of HMW glutenin alleles related to wheat bread quality by PCR-generated DNA markers. *Theor. Appl. Genet.* **101**, 892–896 (2000).
- Shewry, P.R., Tatham, A.S., Barro F., Barcelo P., Lazzari P. Biotechnology of breadmaking: unraveling and manipulating the multi-protein gluten complex. *Biotechnology* **13**, 1185–1190 (1995).
- Shewry, P.R., Tatham, A.S. Disulphide Bonds in Wheat Gluten Proteins. *J. Cereal Sci.* **25**, 207–227 (1997).
- Goldsbrough, A.P., Bulleid, N.J., Freedman, R.B., Flavell, R.B. Conformational differences between two wheat (*Triticum aestivum*) ‘high-molecular-weight’ glutenin subunits are due to a short region containing six amino acid differences. *Biochem. J.* **263**, 837–842 (1989).
- Schwarz, G., Felsenstein, F.G., Wenzel, G. Development and validation of a PCR-based marker assay for negative selection of the HMW glutenin allele Glu-B1-1d (Bx-6) in wheat. *Theor. Appl. Genet.* **109**, 1064–1069 (2004).
- De Bustos, A., Rubio, P., Jouve, N. Molecular characterization of the inactive allele of the gene Glu-A1 and the development of a set of AS-PCR markers for HMW glutenins of wheat. *Theor Appl Genet* **100**, 1085–1094 (2000).

16. Zamani, M.J., Bihamta, M., Naserian, B., Hallajian, M. Selection of Wheat Mutant Genotypes Carrying HMW Glutenin Alleles Related to Baking Quality by Using PCR (STS Method) (2007).
17. Shewry, P.R., Halford, N.G., Tatham, A.S. High-molecular weight subunits of wheat glutenin. *J. Cereal Sci.* **15**, 105–120 (1992).
18. Zuniga J., Rathgeb, P., Jobet, C., Campos, H. Selection of Chilean wheat genotypes carriers of the HMW Glu-D1 x5 through Polymerase Chain Reaction. *Agricultura Técnica (Chile)*. **64**(3), 223-228 (2004).

NOTES



Joint FAO/IAEA Programme
Nuclear Techniques in Food and Agriculture

NOTES



Joint FAO/IAEA Programme
Nuclear Techniques in Food and Agriculture

The year 2008 will mark the 80th anniversary of mutation induction in crop plants. The widespread use of induced mutants has led to date to the official release of close to 3000 mutant plant varieties throughout the world. Many of these varieties have been widely grown by farmers, both in developed and developing countries, resulting in considerable positive economic impacts that are measured in billions of USD. In the past decade, induced mutations have become a means of choice for the discovery of genes that control important traits, and for understanding their functions and mechanisms of actions. The papers included in this book present some of the significant achievements, demonstrate the current development, and outline the perspectives in this dynamic field.

ISBN 978-92-5-106324-8



I0956E/1/07.09/1130