

eZ430-RF2500 Development Tool

User's Guide



Literature Number: SLAU227F
September 2007–Revised June 2015

Preface	4
1 eZ430-RF2500 Overview. Wireless Made Easy.	5
2 Kit Contents, eZ430-RF2500	6
3 Developing With eZ430-RF2500T Target Board	7
4 Specifications	9
5 Supported Devices	10
6 MSP430 Application UART	10
7 Software Installation	11
7.1 Installing the IDE	11
7.2 Installing the Sensor Monitor Visualizer Application	11
8 Hardware Installation	11
9 SimpliCI™ Network Protocol	11
10 Demo – eZ430-RF2500 Sensor Monitor	12
10.1 Demo Hardware Setup	12
10.2 Demo Firmware Download	13
10.3 Demo Software GUI Setup	14
10.4 Demo Options	14
11 Suggested Reading	14
12 Frequently Asked Questions (FAQ)	15
13 eZ430-RF2500 Schematics	16
14 Detailed Hardware Installation Guide	20
15 IAR Workbench Compatibility Guide	22
Revision History	23

List of Figures

1	eZ430-RF2500	5
2	eZ430-RF2500 Battery Board	6
3	eZ430-RF2500 Development Tool	7
4	eZ430-RF2500 USB Debugging Interface 6-Pin Male Header	10
5	9600 bps With No Flow Control	10
6	eZ430-RF2500 Sensor Monitor	12
7	IAR Embedded Workbench KickStart Workspace	13
8	eZ430-RF, USB Debugging Interface, Schematic	16
9	eZ430-RF, USB Debugging Interface, Schematic	17
10	eZ430-RF2500T, Target Board and Battery Board, Schematic	18
11	eZ430-RF, USB Debugger, PCB Components Layout	19
12	eZ430-RF, USB Debugger, PCB Layout	19
13	eZ430-RF2500T, Target Board, PCB Layout	19
14	Windows XP Hardware Recognition	20
15	Windows XP Hardware Recognition for MSP430 Application UART	20
16	Windows XP Found New Hardware Wizard	20
17	Windows XP Hardware Wizard	21
18	Windows XP Warning	21
19	Device Manager	22

List of Tables

1	eZ430-RF2500T Target Board Pinouts	7
2	Battery Board Pinouts	8

Read This First

If You Need Assistance

Support for MSP430™ devices and the eZ430-RF2500 is provided by the TI [Product Information Center \(PIC\)](#). Contact information for the PIC can be found on the TI website at www.ti.com. Additional device-specific information can be found on the MSP430 website at www.ti.com/msp430 and www.ti.com/ez430-rf.

NOTE: IAR Embedded Workbench® KickStart is supported by Texas Instruments.

Although IAR Embedded Workbench KickStart is a product of IAR, Texas Instruments provides support for KickStart. Therefore, please do not request support for KickStart from IAR. Consult all provided documentation with KickStart before requesting assistance.

We Would Like to Hear from You

If you have any comments, feedback, or suggestions, let us know by contacting support@ti.com.

eZ430-RF2500 Development Tool

1 eZ430-RF2500 Overview. Wireless Made Easy.

The eZ430-RF2500 is a complete USB-based MSP430 wireless development tool providing all the hardware and software to evaluate the MSP430F2274 microcontroller and CC2500 2.4-GHz wireless transceiver.

The eZ430-RF2500 uses the IAR Embedded Workbench Integrated Development Environment (IDE) or Code Composer Studio™ (CCS) IDE to write, download, and debug an application. The debugger is unobtrusive, allowing the user to run an application at full speed with both hardware breakpoints and single stepping available while consuming no extra hardware resources.

The eZ430-RF2500T target board is an out-of-the-box wireless system that may be used with the USB debugging interface, as a stand-alone system with or without external sensors, or may be incorporated into an existing design.

The USB debugging interface enables the eZ430-RF2500 to remotely send and receive data from a PC using the MSP430 Application UART.

eZ430-RF2500 features:

- USB debugging and programming interface featuring a driverless installation and application backchannel
- 21 available development pins
- Highly-integrated ultra-low-power MSP430 MCU with 16-MHz performance
- Two general-purpose digital I/O pins connected to green and red LEDs for visual feedback
- Interruptible push button for user feedback

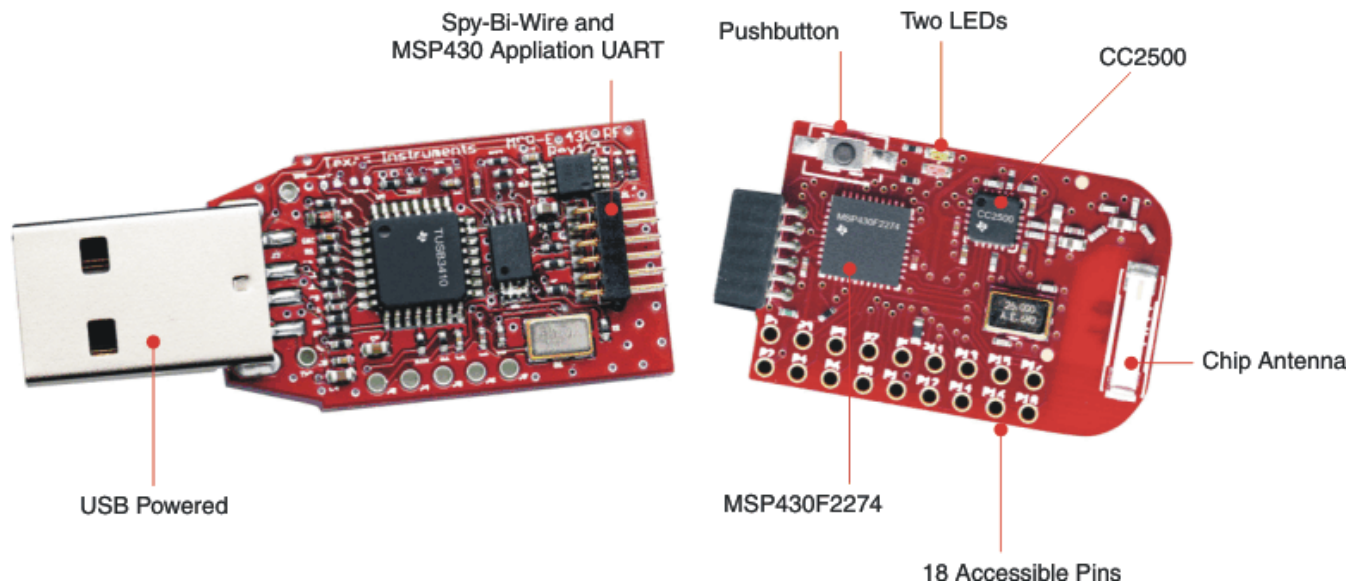

Figure 1. eZ430-RF2500



Figure 2. eZ430-RF2500 Battery Board

2 Kit Contents, eZ430-RF2500

- The hardware includes:
 - Two eZ430-RF2500T target boards
 - One eZ430-RF USB debugging interface
 - One AAA battery pack with expansion board (batteries included)

NOTE: Visit the [TI website](#) for the latest versions of the documentation and development software for eZ430-RF2500:

- *MSP430x2xx Family User's Guide* ([SLAU144](#))
 - *eZ430-RF2500 User's Guide* ([SLAU227](#))
 - [Code Composer Studio \(CCS\) Integrated Development Environment \(IDE\)](#)
 - [IAR Embedded Workbench KickStart IDE](#)
 - eZ430-RF2500 Sensor Monitor (Code and Visualizer) ([SLAC139](#))
-

3 Developing With eZ430-RF2500T Target Board

The eZ430-RF2500 can be used as a stand-alone development tool. Additionally, the eZ430-RF2500 target board also may be detached from the debugging interface and integrated into another design by removing the plastic enclosure. The target board features an MSP430F2274 and most of its pins are easily accessible. The pins are shown in [Figure 3](#) and described in [Table 1](#) and [Table 2](#).

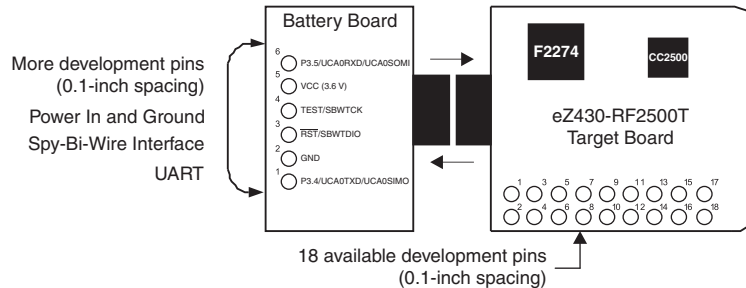

Figure 3. eZ430-RF2500 Development Tool

Table 1. eZ430-RF2500T Target Board Pinouts

Pin	Function	Description
1	GND	Ground reference
2	VCC	Supply voltage
3	P2.0 / ACLK / A0 / OA0I0	General-purpose digital I/O pin ACLK output ADC10, analog input A0
4	P2.1 / TAINCLK / SMCLK / A1 / A00	General-purpose digital I/O pin ADC10, analog input A1 Timer_A, clock signal at INCLK SMCLK signal output
5	P2.2 / TA0 / A2 / OA0I1	General-purpose digital I/O pin ADC10, analog input A2 Timer_A, capture: CCI0B input/BSL receive, compare: OUT0 output
6	P2.3 / TA1 / A3 / VREF- / VeREF- / OA111 / OA10	General-purpose digital I/O pin Timer_A, capture: CCI1B input, compare: OUT1 output ADC10, analog input A3 Negative reference voltage output/input
7	P2.4 / TA2 / A4 / VREF+ / VeREF+ / OA110	General-purpose digital I/O pin Timer_A, compare: OUT2 output ADC10, analog input A4 Positive reference voltage output/input
8	P4.3 / TB0 / A12 / OA00	General-purpose digital I/O pin ADC10 analog input A12 Timer_B, capture: CCI0B input, compare: OUT0 output
9	P4.4 / TB1 / A13 / OA10	General-purpose digital I/O pin ADC10 analog input A13 Timer_B, capture: CCI1B input, compare: OUT1 output
10	P4.5 / TB2 / A14 / OA0I3	General-purpose digital I/O pin ADC10 analog input A14 Timer_B, compare: OUT2 output
11	P4.6 / TBOUTH / A15 / OA1I3	General-purpose digital I/O pin ADC10 analog input A15 Timer_B, switch all TB0 to TB3 outputs to high impedance
12	GND	Ground reference
13	P2.6 / XIN (GDO0)	General-purpose digital I/O pin Input terminal of crystal oscillator
14	P2.7 / XOUT (GDO2)	General-purpose digital I/O pin Output terminal of crystal oscillator

Table 1. eZ430-RF2500T Target Board Pinouts (continued)

Pin	Function	Description
15	P3.2 / UCB0SOMI / UCB0SCL	General-purpose digital I/O pin USCI_B0 slave out/master in when in SPI mode SCL I ² C clock in I ² C mode
16	P3.3 / UCB0CLK / UCA0STE	General-purpose digital I/O pin USCI_B0 clock input/output USCI_A0 slave transmit enable
17	P3.0 / UCB0STE / UCA0CLK / A5	General-purpose digital I/O pin USCI_B0 slave transmit enable USCI_A0 clock input/output ADC10, analog input A5
18	P3.1 / UCB0SIMO / UCB0SDA	General-purpose digital I/O pin USCI_B0 slave in/master out in SPI mode SDA I ² C data in I ² C mode

Table 2. Battery Board Pinouts

Pin	Function	Description
1	P3.4 / UCA0TXD / UCA0SIMO	General-purpose digital I/O pin USCI_A0 transmit data output in UART mode (UART communication from 2274 to PC) Slave in/master out in SPI mode
2	GND	Ground reference
3	$\overline{\text{RST}}$ / SBWTDIO	Reset or nonmaskable interrupt input Spy-Bi-Wire test data input/output during programming and test
4	TEST / SBWTCK	Selects test mode for JTAG pins on Port1. The device protection fuse is connected to TEST. Spy-Bi-Wire test clock input during programming and test
5	VCC (3.6V)	Supply voltage
6	P3.5 / UCA0RXD / UCA0SOMI	General-purpose digital I/O pin USCI_A0 receive data input in UART mode (UART communication from 2274 to PC) Slave out/master in when in SPI mode

4 Specifications

MSP430F2274

- 16-MIPS performance
- 200-kSPS 10-bit SAR ADC
- Two built-in operational amplifiers
- Watchdog timer, 16-bit Timer_A3 and Timer_B3
- USCI module supports UART/LIN, (2) SPI, I²C, or IrDA
- Five low-power modes that draw as little as 700 nA in standby

PARAMETER	MIN	TYP	MAX	UNIT
OPERATING CONDITIONS				
Operating supply voltage	1.8		3.6	V
Operating free-air temperature range	-40		85	°C
CURRENT CONSUMPTION				
Active mode at 1 MHz, 2.2 V		270	390	μA
Standby mode		0.7	1.4	μA
Off mode with RAM retention		0.1	0.5	μA
OPERATING FREQUENCY				
VCC ≥ 3.3 V			16	MHz

CC2500

- 2.4-GHz radio-frequency (RF) transceiver
- Programmable data rate up to 500 kbps
- Low current consumption

PARAMETER	TEST CONDITIONS	MIN	TYP	MAX	UNIT
OPERATING CONDITIONS					
Operating supply voltage		1.8		3.6	V
CURRENT CONSUMPTION					
RX input signal at the sensitivity limit, 250 kbps	Optimized current		16.6		mA
	Optimized sensitivity		18.8		
RX input signal 30 dB above the sensitivity limit, 250 kbps	Optimized current		13.3		mA
	Optimized sensitivity		15.7		
Current consumption TX (0 dBm)			21.2		mA
Current consumption TX (-12 dBm)			11.1		mA
RF CHARACTERISTICS					
Frequency range		2400		2483.5	MHz
Data rate (programmable)		1.2		500	kbps
Output power (programmable)		-30		0	dBm
Sensitivity, 10 kbps	Optimized current, 2-FSK, 230-kHz RX filter bandwidth, 1% PER		-99		dBm
	Optimized sensitivity		-101		
Sensitivity, 250 kbps	Optimized current, 500-kHz RX filter bandwidth, 1% PER		-87		
	Optimized sensitivity		-89		

5 Supported Devices

The eZ430-RF USB debugging interface may be used as a standard Flash Emulation Tool through its Spy-Bi-Wire interface. The eZ430-RF USB debugging interface supports the following MSP430 families:

- MSP430F20xx
- MSP430F22xx

The connector on the USB debugging interface is backward compatible with the eZ430-F2013 and T2012 target boards.

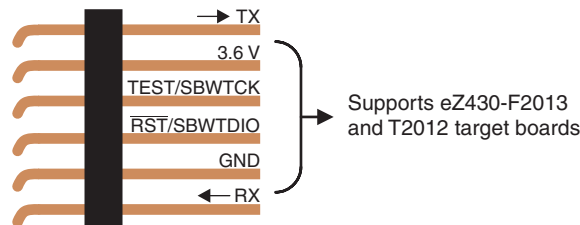

Figure 4. eZ430-RF2500 USB Debugging Interface 6-Pin Male Header

6 MSP430 Application UART

The eZ430-RF USB debugging interface features a back channel MSP430 Application UART that may be used independently of a debug session. This allows the user to transfer serial data to a terminal window at a fixed rate of 9600 bps with no flow control. See [Figure 5](#) for typical settings.

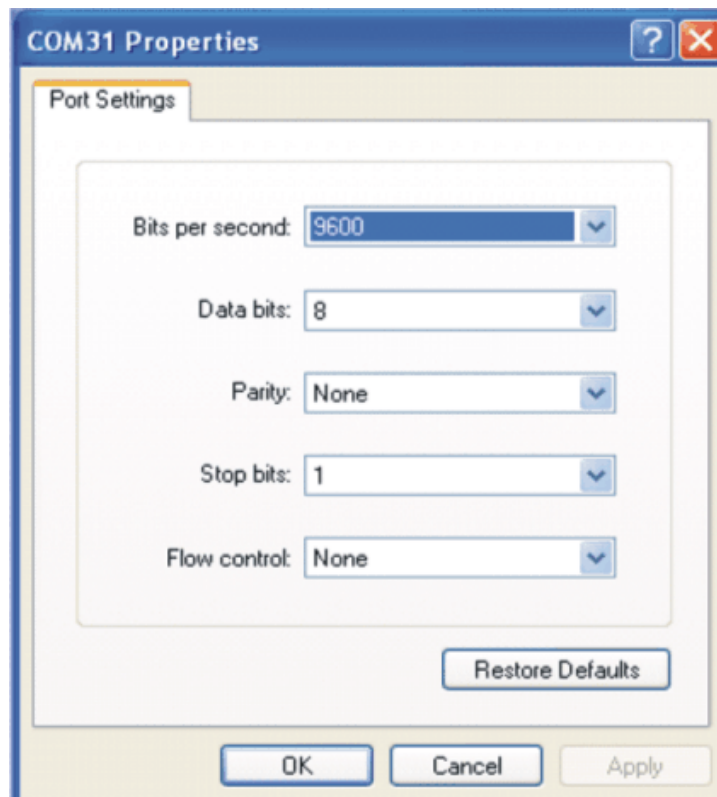

Figure 5. 9600 bps With No Flow Control

Check the Device Manager for COM port assignment of the MSP430 Application UART. For more details, see [Section 14](#).

7 Software Installation

Two different development software tools for the MSP430 are available from TI: IAR Embedded Workbench KickStart and Code Composer Studio (CCS). The term "KickStart" refers to the limited version of Embedded Workbench that allows up to 4KB of C-code compilation.

7.1 Installing the IDE

1. Download the IDE of your choice:
IAR Embedded Workbench KickStart: <http://www.ti.com/tool/IAR-KICKSTART>
Code Composer Studio: <http://www.ti.com/tool/ccstudio>
2. Respond to the prompts to install the software. The installation procedure installs the IDE and TI files.

7.2 Installing the Sensor Monitor Visualizer Application

1. Download the latest version of eZ430-RF2500 Sensor Monitor (Code and Visualizer):
<http://www.ti.com/lit/zip/slac139>
2. Run **Sensor Monitor Installer.exe**.
3. Choose the installation path for the software.
4. Open the eZ430-RF2500 Sensor Monitor using the shortcut that is installed on the desktop.

8 Hardware Installation

1. Insert the eZ430-RF into USB port. The debugging interface automatically installs itself.
2. When prompted for the software for the MSP430 Application UART, allow Windows to **install the software automatically**. This is only possible if either IAR KickStart R4.64 (or higher) or the Sensor Monitor Visualizer has already been installed. For more information, see [Section 14](#).

9 SimpliciTI™ Network Protocol

The SimpliciTI™ network protocol is a proprietary, low-power radio-frequency (RF) protocol targeting simple, small RF networks (<100 nodes). The SimpliciTI network protocol is designed for easy implementation with minimal microcontroller resource requirements. The protocol runs out of the box on TI's MSP430 ultra-low-power microcontrollers and multiple RF transceivers.

Small low-power RF networks typically contain battery-operated devices, which require long battery life, low data rate, and low duty cycle, and have a limited number of nodes talking directly to each other. With the SimpliciTI network protocol, MCU resource requirements are minimal, resulting in lower system cost for low-power RF networks. More complex mesh networks that need routing typically require 10× the program memory and RAM to implement.

Despite the modest resources required, SimpliciTI network protocol supports End Devices in a peer-to-peer network topology, the option to use an Access Point to store and forward messages, and Range Extenders to extend the range of the network up to four hops. Future releases will add more sophisticated features such as frequency agility, an ETSI-compliant listen-before-talk discipline, and a software security routine for message encryption.

The SimpliciTI network protocol supports a wide range of low-power applications including alarm and security (smoke detectors, glass breakage detectors, carbon monoxide sensors, and light sensors), automated meter reading (gas meters and water meters), home automation (appliances, garage door openers, and environmental devices), and active RFID.

The SimpliciTI network protocol is provided as source code under a free license without royalties.

Developers are encouraged to adapt the protocol to their own specific application needs. For information on compatibility, updates, and the latest version of the SimpliciTI protocol, visit www.ti.com/simpliciti.

The eZ430-RF2500 demonstration application uses the SimpliciTI protocol to demonstrate a temperature sensor network application that provides a starting point to develop a wireless applications.

10 Demo – eZ430-RF2500 Sensor Monitor

eZ430-RF2500 is preloaded with a wireless temperature sensor network firmware and may be reprogrammed at any time. This network consists of an Access Point that measures its own temperature and also wirelessly receives temperature measurements from End Devices. End Devices measure their temperature once per second and then enter a low-power mode to reduce battery usage. The Access Point transmits all measured data to the PC through the UART backchannel. The included PC Sensor Monitor Visualizer provides a demonstration of the eZ430-RF2500 using the SimpliciTI protocol across a star network. In the PC Sensor Monitor Visualizer, the center node is the Access Point and the attached bubbles are the End Devices. The PC application displays the temperature of both the End Devices and Access Point. Additionally, the PC application is capable of simulating distance from its access point when the End Devices are moved. The number of End Devices can be expanded by adding more target boards in the star network as seen in [Figure 6](#).

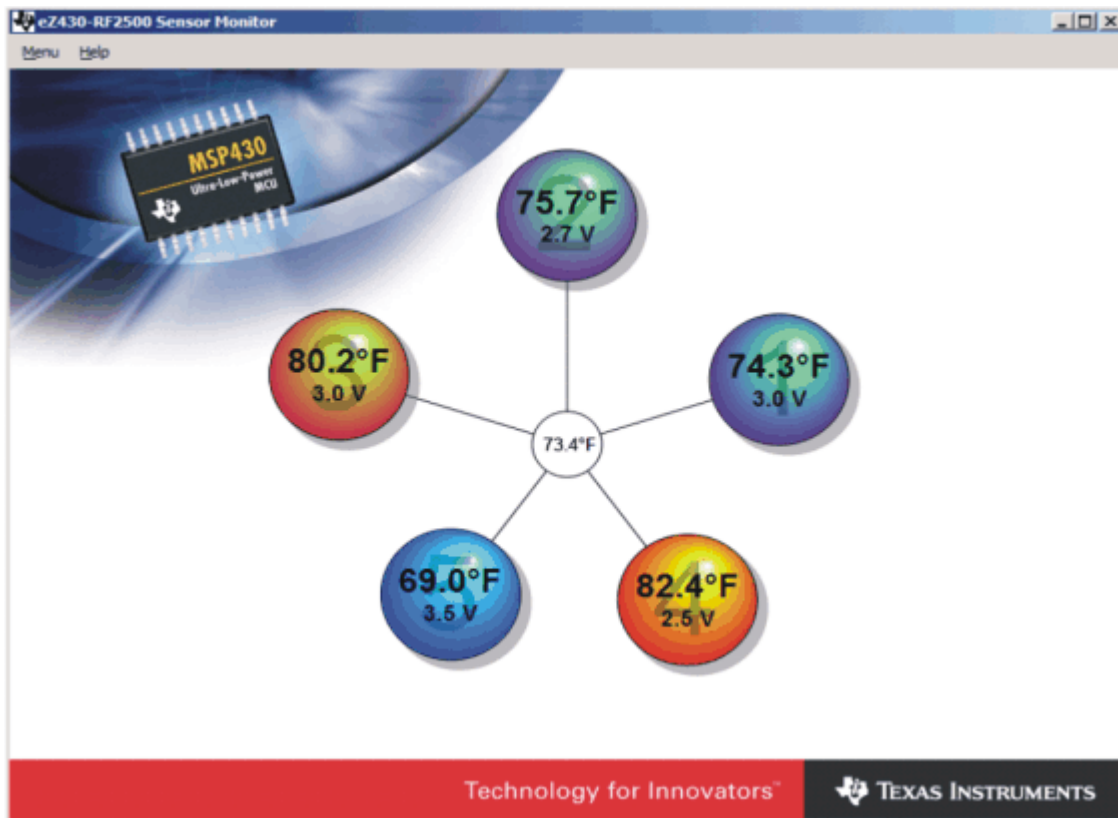

Figure 6. eZ430-RF2500 Sensor Monitor

10.1 Demo Hardware Setup

1. Connect the eZ430-RF2500 to a USB port on the PC.
2. Connect the second eZ430-RF2500T target board to the battery board. Insert the jumper on the board to power up the device.

10.2 Demo Firmware Download

The following steps describe how to update the demo application firmware on the eZ430-RF2500 target boards and are not required out of the box.

1. Download the demo software from at <http://www.ti.com/lit/zip/slac139> and extract the archive to your local drive.
2. Open IAR Workbench KickStart.
3. Select Open Existing Workspace, and browse for the demo application workspace (*.eww) file.
4. To download demo firmware, follow step 4a for Access Point firmware and step 4b for End Device firmware.
 - (a) Right click on **Access Point** project in the workspace and click **Set as Active** as shown in Figure 7.
 - (b) Right click on **End Device** project in the workspace and click **Set as Active**.

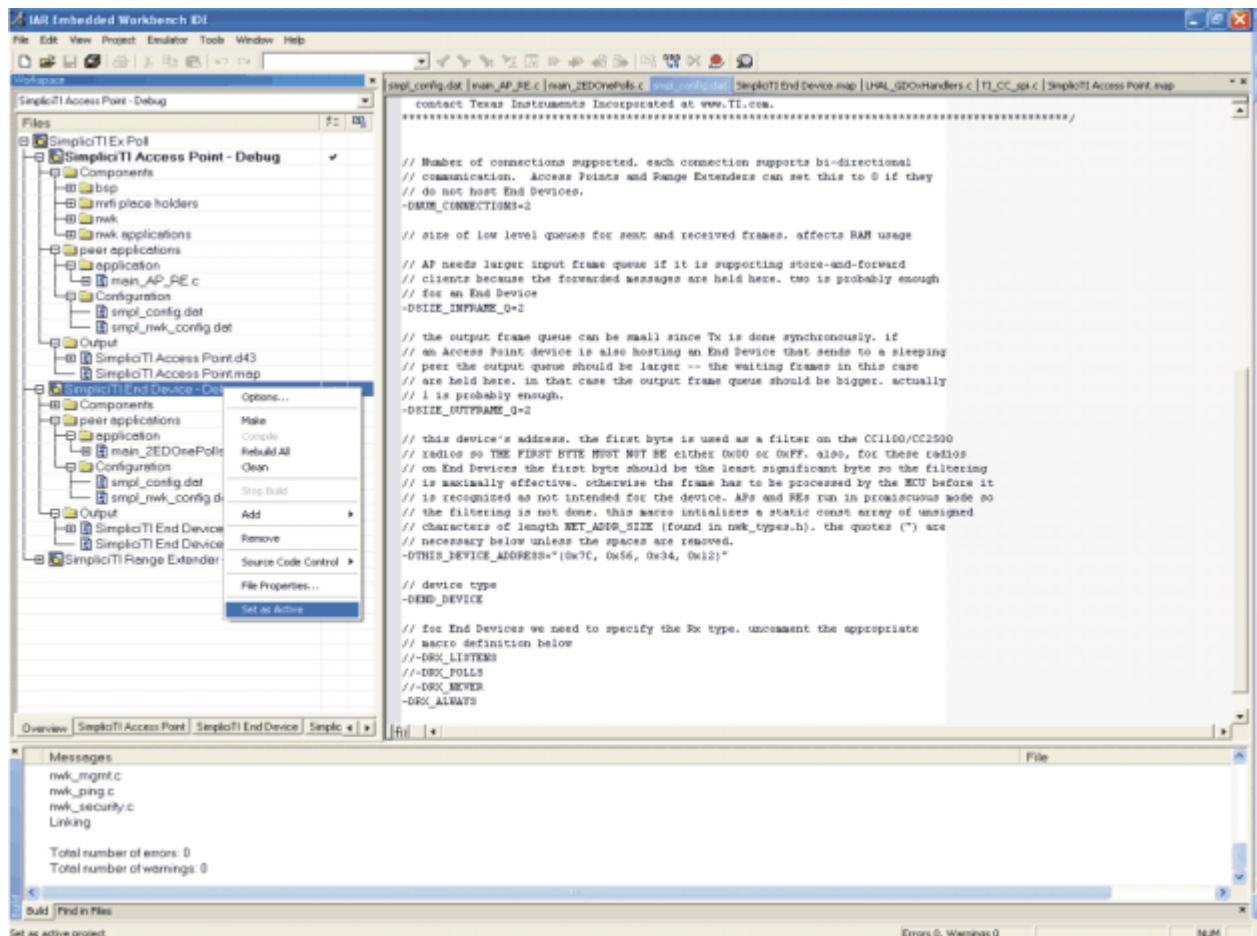

Figure 7. IAR Embedded Workbench KickStart Workspace

5. Select **Project** → **Debug in IAR** to download the code for the target boards.
6. Select **Debug** → **Go** to start running code while in debug mode.
7. Select **Debug** → **Stop Debugging** exits the debug mode while leaving the target board executing code.

10.3 Demo Software GUI Setup

1. Download the [latest version of the demo software](#) and run **Sensor Monitor Installer.exe** from the **PC** folder. After installation, a shortcut is placed on the desktop.
2. Ensure the Access Point is connected to the PC.
3. Apply power to the End Device.
4. Launch eZ430-RF2500 Sensor Monitor Demo Visualizer. The application should automatically display End Devices when in range.

10.4 Demo Options

1. Go to **Menu** → **Settings**.
2. Under the settings menu, the demo application is capable of displaying values in Celsius or Fahrenheit.
3. Checking the box **Disable Animations** disables the dynamic distance change, thus decreasing CPU processing on PC.
4. See the demo application help file by clicking **Help** for more detailed options.

11 Suggested Reading

The primary sources of MSP430 information are the device-specific data sheets and user's guides. The most current information is found at www.ti.com/msp430. Information specific to the eZ430-RF2500 development tool can be found at www.ti.com/ez430-rf.

MSP430 device user's guides and the FET user's guide may be accessed from the website. The FET user's guide includes detailed information on setting up a project for the MSP430 using IAR.

Documents that describe the IAR tools (Workbench/C-SPY, the assembler, the C compiler, the linker, and the library) are installed with the IDE in common\doc and 430\doc. The documents are in PDF format. Supplements to the documents (the latest information) are available in HTML format in the same directories. 430\doc\readme_start.htm provides a convenient starting point for navigating the IAR documentation.

12 Frequently Asked Questions (FAQ)

1. Does the eZ430-RF2500 support fuse blow?

The eZ430-RF USB debugging interface lacks the JTAG security fuse-blow capability. To ensure firmware security on devices going to production, the USB Flash Emulation Tool or the Gang Programmer, which include the fuse-blow feature, are recommended.

2. What is the voltage supplied to the eZ430-RF2500T target board from the debugging interface?

The eZ430-RF USB debugging interface supplies a regulated 3.6 V to the eZ430-RF2500T target board.

3. Can other programming tools interface to the eZ430-RF2500T target board?

The eZ430-RF2500T target board works with any programming tool supporting the 2-wire Spy-Bi-Wire interface. Both the MSP430 USB FET (MSP-FET430UIF) and the Gang Programmer (MSP-GANG430) support these devices. See MSP-FET430 Flash Emulation Tool User's Guide (SLAU138) for details on using MSP430 USB FET and the Gang Programmer for a 2-wire Spy-Bi-Wire interface.

4. What versions of IAR Embedded Workbench and Code Composer Studio are supported?

The eZ430-RF2500 hardware is supported by IAR Embedded Workbench KickStart Release 4.64 (IAR 3.42F) and Code Composer Studio v4 or higher.

5. What are the part numbers for the connectors between the eZ430-RF USB debugger and the eZ430-RF2500T target board?

Header: Mill-Max 850-10-006-20-001000

Socket: Mill-Max 851-93-006-20-001000

6. Where can I obtain more information about the 2.4-GHz chip antenna?

Part Number: 7488910245

Würth Elektronik Group: www.we-online.com

7. I am not able to select the MSP430 Application UART, cannot receive data, or the demo app doesn't appear to change.

Ensure that the Application UART driver is correctly installed. Install either the Sensor Monitor Visualizer or IAR KickStart 3.42F or higher and follow the directions in [Section 14](#).

To determine if the driver is correctly installed:

- Plug in the eZ430-RF USB debugging interface.
- Right click **My Computer** and select **Properties**.
- Select the **Hardware** tab and click on **Device Manager**.
- Under **Ports (COM & LPT)** should be an entry for "MSP430 Application UART (COM xx)".

If the entry is there, but no characters are received, restart the PC.

If the Application UART is not listed, install the driver by following the instructions in [Section 14](#).

8. When trying to compile the Sensor Monitor Demo project in IAR, I receive the following error:

```
Error[e117]: Incompatible runtime models. Module ISR specifies that '__rt_version' must be '3', but module LHAL_GDOxHandlers has the value '2'
```

Use the [latest version of the demo software](#) and use IAR KickStart v4.x or later.

Early versions of the demo code included a precompiled version of the SimpliciTI library for IAR 3.x. IAR 4.x changes the calling conventions, which returns Error[e117] when trying to build libraries for an older version of the compiler.

9. What kind of range should I expect to get with the eZ430-RF2500?

Based on practical range testing with one node connected to a PC and the other node connected to the battery board, we have measured indoor line-of-sight range of more than 50 meters. This range can be significantly affected by the orientation of the boards and the environment. Note that the eZ430-RF2500 target board was designed to optimize for factor and does not focus on maximizing RF range. Visit the TI website for additional reference designs and antenna options.

10. Why is my battery board different than in the documentation?

Since introduction, the eZ430RF-2500 battery board was slightly modified. The connections and function remain the same.

13 eZ430-RF2500 Schematics

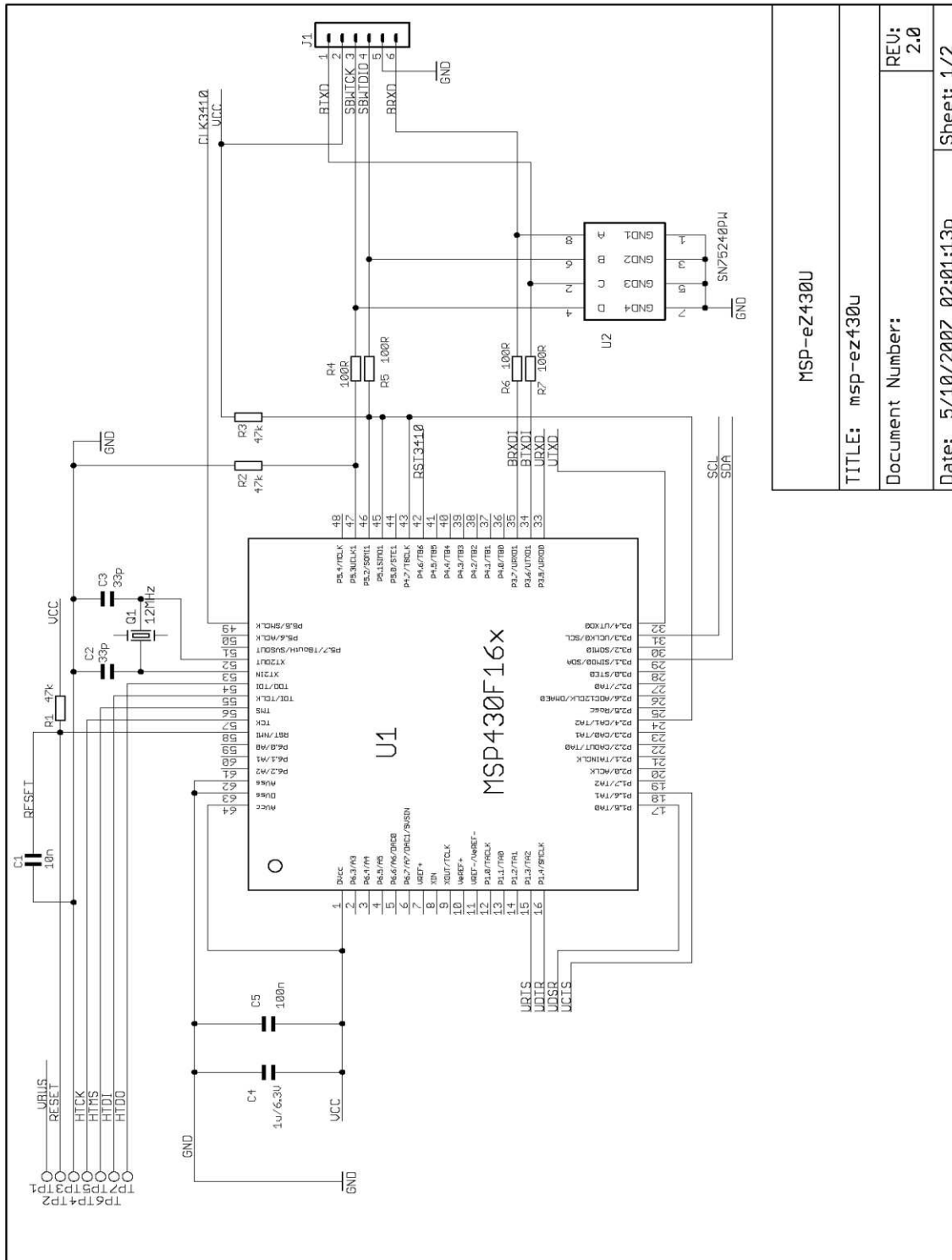

MSP-eZ430U	
TITLE: msp-ez430u	
Document Number:	REU: 2.0
Date: 5/10/2007 02:01:13p	Sheet: 1/2

Figure 8. eZ430-RF, USB Debugging Interface, Schematic

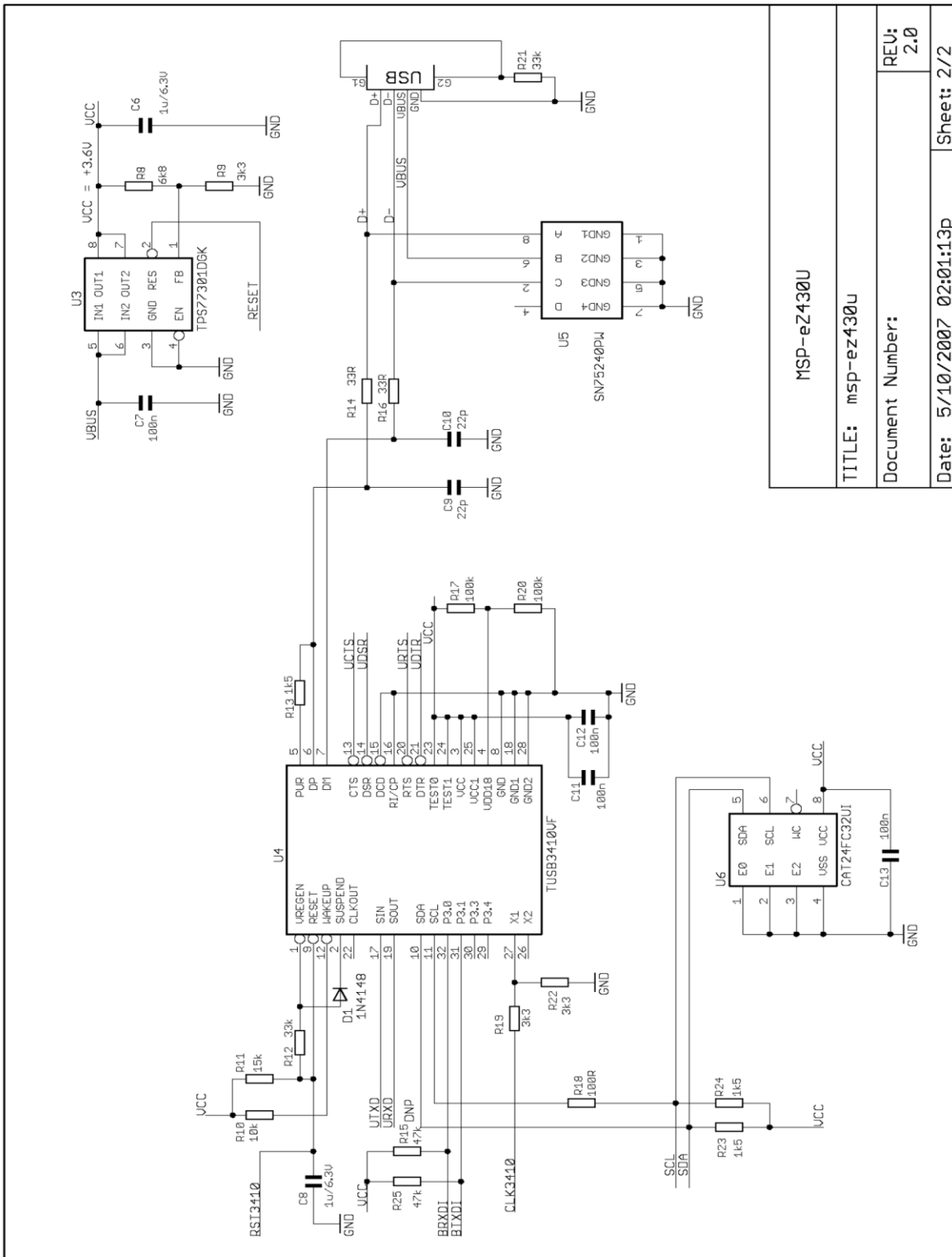

MSP-eZ430U	
TITLE: msp-ez430u	
Document Number:	
Date: 5/10/2007 02:01:13p	Sheet: 2/2
REV: 2.0	

Figure 9. eZ430-RF, USB Debugging Interface, Schematic

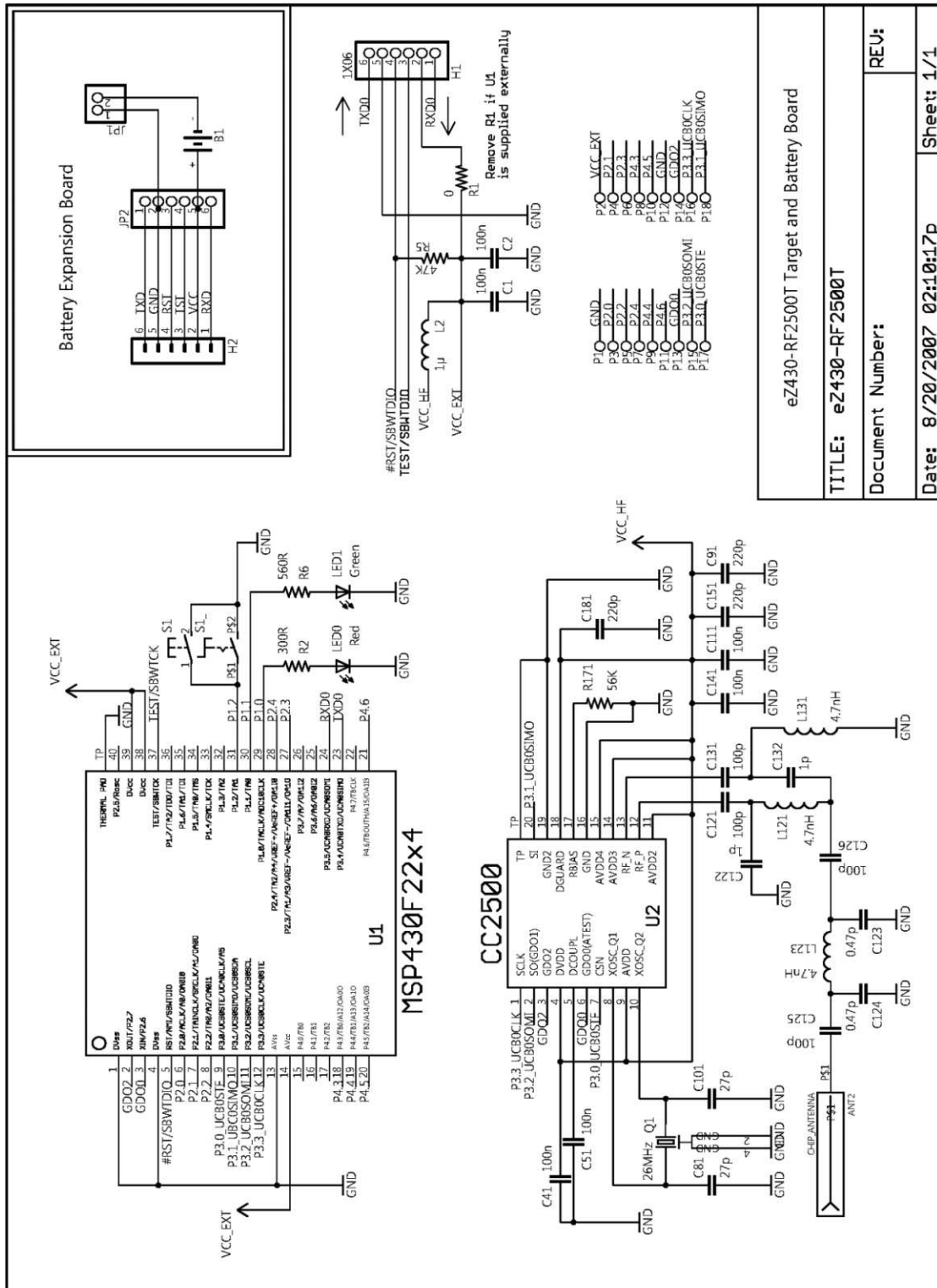

Figure 10. eZ430-RF2500T, Target Board and Battery Board, Schematic

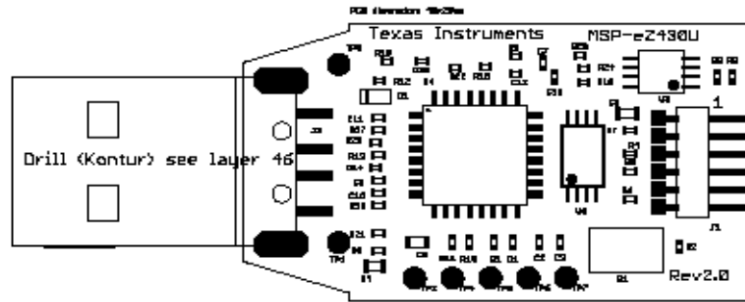

Figure 11. eZ430-RF, USB Debugger, PCB Components Layout

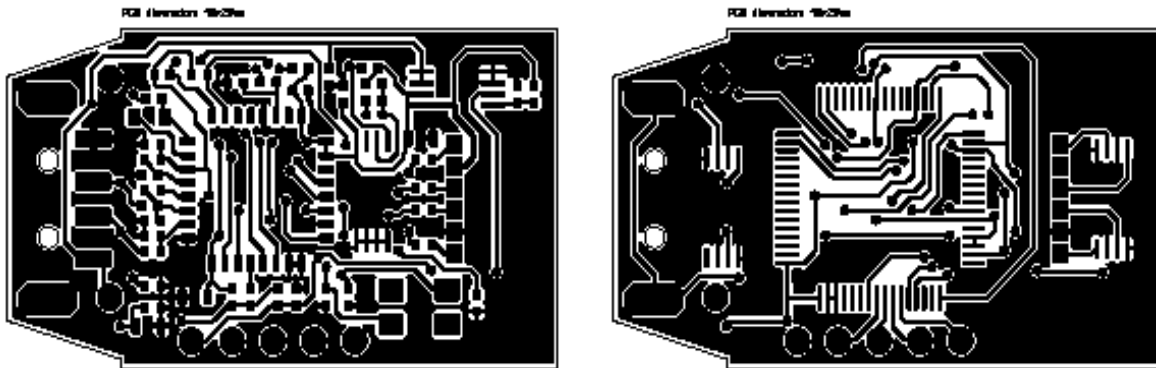

Figure 12. eZ430-RF, USB Debugger, PCB Layout

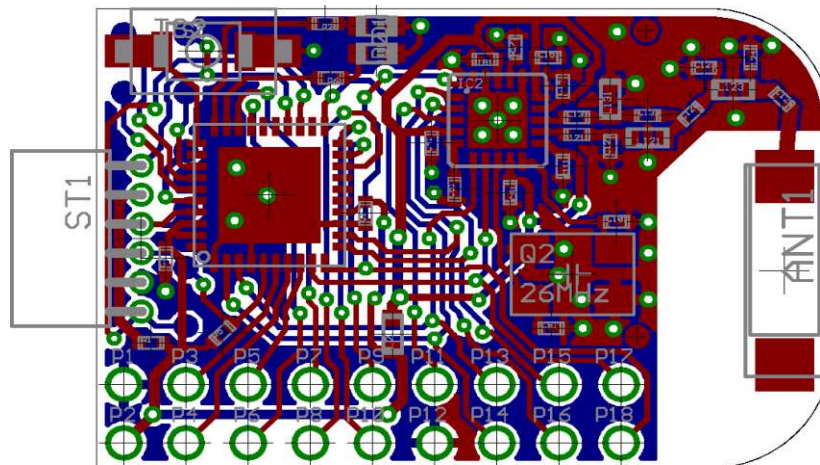

Figure 13. eZ430-RF2500T, Target Board, PCB Layout

14 Detailed Hardware Installation Guide

1. Download the demo software from at <http://www.ti.com/lit/zip/slac139> and extract the archive to the local drive.
2. Install the eZ430-RF2500 Sensor Monitor Demo Visualizer from the PC folder in the demo software zip. This installs the necessary drivers on your system.
3. Insert the eZ430-RF2500 into a USB port of the PC.
4. Windows should recognize the new hardware as **Texas Instruments MSP-FET430UIF** (see [Figure 14](#)). Windows should automatically install the drivers for the MSP-FET430UIF as a HID tool.



Figure 14. Windows XP Hardware Recognition

5. Windows recognizes another new hardware driver to be installed called **MSP430 Application UART** (see [Figure 15](#)).

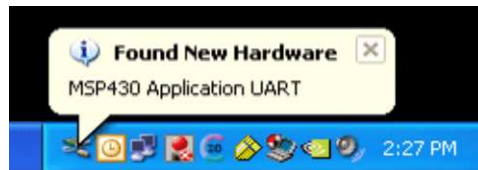

Figure 15. Windows XP Hardware Recognition for MSP430 Application UART

NOTE: This Installation Step is **Optional**. The USB debugging interface works without the MSP430 Application UART as long as (R4.64 or newer) IAR Workbench is used.

6. The Found New Hardware Wizard opens a dialog window. Select No, not this time and click Next (see [Figure 16](#)).



Figure 16. Windows XP Found New Hardware Wizard

7. Select **Install the software automatically (Recommended)** (see [Figure 17](#)), if IAR KickStart R4.64 or higher has already been installed.

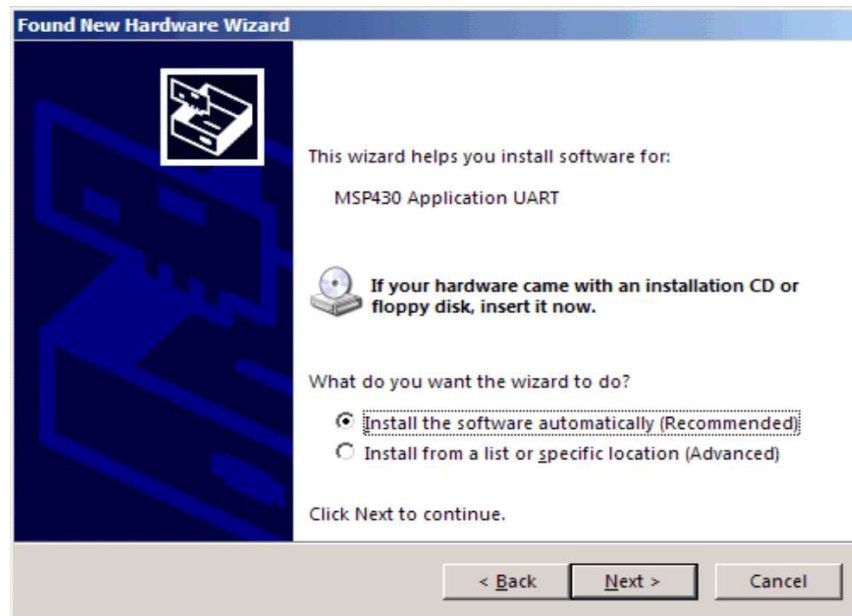

Figure 17. Windows XP Hardware Wizard

8. The Wizard should find the appropriate driver for a Windows XP system; it shows a warning that Microsoft did not certify the driver. The drivers have been tested exhaustively, and this warning may be ignored. Click **Continue Anyway** (see [Figure 18](#)).



Figure 18. Windows XP Warning

9. The Wizard continues to install the driver and then provides notification when it has finished the installation of the software.

10. The eZ430-RF2500 is now installed and ready to use. The assigned COM port for the MSP430 Application UART is shown in the Windows Device Manager (see [Figure 19](#)).

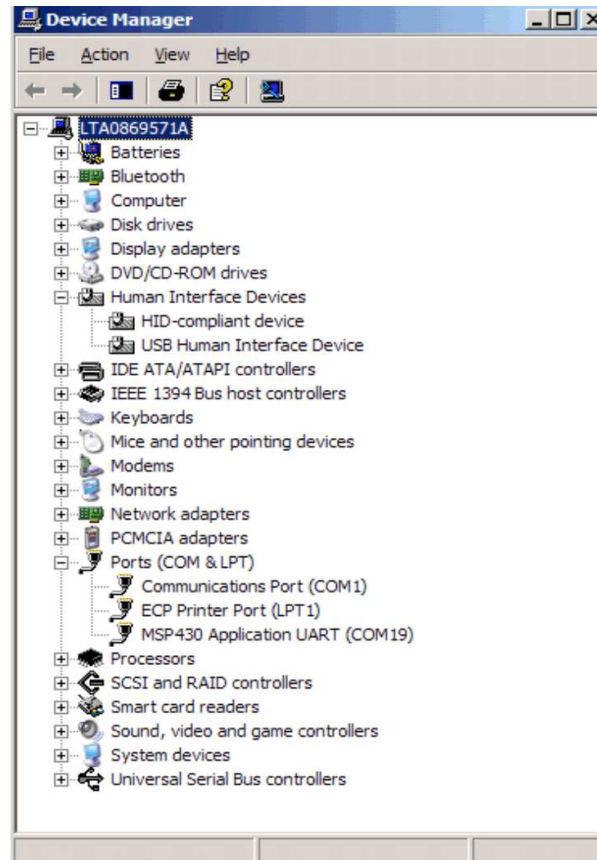

Figure 19. Device Manager

15 IAR Workbench Compatibility Guide

NOTE: In this document, "IAR version" refers to the IAR compiler version. This can be obtained by clicking **Help** → **About** → **Product Info**.

IAR KickStart version 3.42F (FET_R4.64)

- Minimum version compatible with eZ430-RF USB debugging interface board
- Compatible with eZ430-RF2500 Sensor Monitor demo v1.00

IAR KickStart version 4.09A+ (FET_R5.10+)

- Compatible with eZ430-RF USB debugging interface board
- Compatible with SimpliciTI libraries 1.0.3+
- Compatible with eZ430-RF2500 Sensor Monitor demo v1.02+

Revision History

Changes from April 2, 2009 to June 15, 2015	Page
• Removed CD from kit contents (no longer included) and updated links to related documentation and software	6
• Removed references to install CD, and changed all references and links for CCE to CCS	11
• Changed description in Section 10.2 , <i>Demo Firmware Download</i> , for software download instead of install from CD	13
• Changed description in Section 10.3 , <i>Demo Software GUI Setup</i> , for software download instead of install from CD	14
• Changed description in Section 11 , <i>Suggested Reading</i> , to refer to the TI website for additional information	14
• Changed step 1 in Section 14 , <i>Detailed Hardware Installation Guide</i> , to download software instead of load from CD ...	20

NOTE: Page numbers for previous revisions may differ from page numbers in the current version.

STANDARD TERMS AND CONDITIONS FOR EVALUATION MODULES

1. *Delivery:* TI delivers TI evaluation boards, kits, or modules, including any accompanying demonstration software, components, or documentation (collectively, an "EVM" or "EVMs") to the User ("User") in accordance with the terms and conditions set forth herein. Acceptance of the EVM is expressly subject to the following terms and conditions.
 - 1.1 EVMs are intended solely for product or software developers for use in a research and development setting to facilitate feasibility evaluation, experimentation, or scientific analysis of TI semiconductors products. EVMs have no direct function and are not finished products. EVMs shall not be directly or indirectly assembled as a part or subassembly in any finished product. For clarification, any software or software tools provided with the EVM ("Software") shall not be subject to the terms and conditions set forth herein but rather shall be subject to the applicable terms and conditions that accompany such Software
 - 1.2 EVMs are not intended for consumer or household use. EVMs may not be sold, sublicensed, leased, rented, loaned, assigned, or otherwise distributed for commercial purposes by Users, in whole or in part, or used in any finished product or production system.
2. *Limited Warranty and Related Remedies/Disclaimers:*
 - 2.1 These terms and conditions do not apply to Software. The warranty, if any, for Software is covered in the applicable Software License Agreement.
 - 2.2 TI warrants that the TI EVM will conform to TI's published specifications for ninety (90) days after the date TI delivers such EVM to User. Notwithstanding the foregoing, TI shall not be liable for any defects that are caused by neglect, misuse or mistreatment by an entity other than TI, including improper installation or testing, or for any EVMs that have been altered or modified in any way by an entity other than TI. Moreover, TI shall not be liable for any defects that result from User's design, specifications or instructions for such EVMs. Testing and other quality control techniques are used to the extent TI deems necessary or as mandated by government requirements. TI does not test all parameters of each EVM.
 - 2.3 If any EVM fails to conform to the warranty set forth above, TI's sole liability shall be at its option to repair or replace such EVM, or credit User's account for such EVM. TI's liability under this warranty shall be limited to EVMs that are returned during the warranty period to the address designated by TI and that are determined by TI not to conform to such warranty. If TI elects to repair or replace such EVM, TI shall have a reasonable time to repair such EVM or provide replacements. Repaired EVMs shall be warranted for the remainder of the original warranty period. Replaced EVMs shall be warranted for a new full ninety (90) day warranty period.
3. *Regulatory Notices:*
 - 3.1 *United States*
 - 3.1.1 *Notice applicable to EVMs not FCC-Approved:*

This kit is designed to allow product developers to evaluate electronic components, circuitry, or software associated with the kit to determine whether to incorporate such items in a finished product and software developers to write software applications for use with the end product. This kit is not a finished product and when assembled may not be resold or otherwise marketed unless all required FCC equipment authorizations are first obtained. Operation is subject to the condition that this product not cause harmful interference to licensed radio stations and that this product accept harmful interference. Unless the assembled kit is designed to operate under part 15, part 18 or part 95 of this chapter, the operator of the kit must operate under the authority of an FCC license holder or must secure an experimental authorization under part 5 of this chapter.
 - 3.1.2 *For EVMs annotated as FCC – FEDERAL COMMUNICATIONS COMMISSION Part 15 Compliant:*

CAUTION

This device complies with part 15 of the FCC Rules. Operation is subject to the following two conditions: (1) This device may not cause harmful interference, and (2) this device must accept any interference received, including interference that may cause undesired operation.

Changes or modifications not expressly approved by the party responsible for compliance could void the user's authority to operate the equipment.

FCC Interference Statement for Class A EVM devices

NOTE: This equipment has been tested and found to comply with the limits for a Class A digital device, pursuant to part 15 of the FCC Rules. These limits are designed to provide reasonable protection against harmful interference when the equipment is operated in a commercial environment. This equipment generates, uses, and can radiate radio frequency energy and, if not installed and used in accordance with the instruction manual, may cause harmful interference to radio communications. Operation of this equipment in a residential area is likely to cause harmful interference in which case the user will be required to correct the interference at his own expense.

FCC Interference Statement for Class B EVM devices

NOTE: This equipment has been tested and found to comply with the limits for a Class B digital device, pursuant to part 15 of the FCC Rules. These limits are designed to provide reasonable protection against harmful interference in a residential installation. This equipment generates, uses and can radiate radio frequency energy and, if not installed and used in accordance with the instructions, may cause harmful interference to radio communications. However, there is no guarantee that interference will not occur in a particular installation. If this equipment does cause harmful interference to radio or television reception, which can be determined by turning the equipment off and on, the user is encouraged to try to correct the interference by one or more of the following measures:

- Reorient or relocate the receiving antenna.
- Increase the separation between the equipment and receiver.
- Connect the equipment into an outlet on a circuit different from that to which the receiver is connected.
- Consult the dealer or an experienced radio/TV technician for help.

3.2 Canada

3.2.1 For EVMs issued with an Industry Canada Certificate of Conformance to RSS-210

Concerning EVMs Including Radio Transmitters:

This device complies with Industry Canada license-exempt RSS standard(s). Operation is subject to the following two conditions: (1) this device may not cause interference, and (2) this device must accept any interference, including interference that may cause undesired operation of the device.

Concernant les EVMs avec appareils radio:

Le présent appareil est conforme aux CNR d'Industrie Canada applicables aux appareils radio exempts de licence. L'exploitation est autorisée aux deux conditions suivantes: (1) l'appareil ne doit pas produire de brouillage, et (2) l'utilisateur de l'appareil doit accepter tout brouillage radioélectrique subi, même si le brouillage est susceptible d'en compromettre le fonctionnement.

Concerning EVMs Including Detachable Antennas:

Under Industry Canada regulations, this radio transmitter may only operate using an antenna of a type and maximum (or lesser) gain approved for the transmitter by Industry Canada. To reduce potential radio interference to other users, the antenna type and its gain should be so chosen that the equivalent isotropically radiated power (e.i.r.p.) is not more than that necessary for successful communication. This radio transmitter has been approved by Industry Canada to operate with the antenna types listed in the user guide with the maximum permissible gain and required antenna impedance for each antenna type indicated. Antenna types not included in this list, having a gain greater than the maximum gain indicated for that type, are strictly prohibited for use with this device.

Concernant les EVMs avec antennes détachables

Conformément à la réglementation d'Industrie Canada, le présent émetteur radio peut fonctionner avec une antenne d'un type et d'un gain maximal (ou inférieur) approuvé pour l'émetteur par Industrie Canada. Dans le but de réduire les risques de brouillage radioélectrique à l'intention des autres utilisateurs, il faut choisir le type d'antenne et son gain de sorte que la puissance isotrope rayonnée équivalente (p.i.r.e.) ne dépasse pas l'intensité nécessaire à l'établissement d'une communication satisfaisante. Le présent émetteur radio a été approuvé par Industrie Canada pour fonctionner avec les types d'antenne énumérés dans le manuel d'usage et ayant un gain admissible maximal et l'impédance requise pour chaque type d'antenne. Les types d'antenne non inclus dans cette liste, ou dont le gain est supérieur au gain maximal indiqué, sont strictement interdits pour l'exploitation de l'émetteur.

3.3 Japan

3.3.1 *Notice for EVMs delivered in Japan:* Please see http://www.tij.co.jp/lstds/ti_ja/general/eStore/notice_01.page 日本国内に輸入される評価用キット、ボードについては、次のところをご覧ください。
http://www.tij.co.jp/lstds/ti_ja/general/eStore/notice_01.page

3.3.2 *Notice for Users of EVMs Considered "Radio Frequency Products" in Japan:* EVMs entering Japan may not be certified by TI as conforming to Technical Regulations of Radio Law of Japan.

If User uses EVMs in Japan, not certified to Technical Regulations of Radio Law of Japan, User is required by Radio Law of Japan to follow the instructions below with respect to EVMs:

1. Use EVMs in a shielded room or any other test facility as defined in the notification #173 issued by Ministry of Internal Affairs and Communications on March 28, 2006, based on Sub-section 1.1 of Article 6 of the Ministry's Rule for Enforcement of Radio Law of Japan,
2. Use EVMs only after User obtains the license of Test Radio Station as provided in Radio Law of Japan with respect to EVMs, or
3. Use of EVMs only after User obtains the Technical Regulations Conformity Certification as provided in Radio Law of Japan with respect to EVMs. Also, do not transfer EVMs, unless User gives the same notice above to the transferee. Please note that if User does not follow the instructions above, User will be subject to penalties of Radio Law of Japan.

【無線電波を送信する製品の開発キットをお使いになる際の注意事項】 開発キットの中には技術基準適合証明を受けていないものがあります。技術適合証明を受けていないものご使用に際しては、電波法遵守のため、以下のいずれかの措置を取っていただく必要がありますのでご注意ください。

1. 電波法施行規則第6条第1項第1号に基づく平成18年3月28日総務省告示第173号で定められた電波暗室等の試験設備でご使用いただく。
2. 実験局の免許を取得後ご使用いただく。
3. 技術基準適合証明を取得後ご使用いただく。

なお、本製品は、上記の「ご使用にあたっての注意」を譲渡先、移転先に通知しない限り、譲渡、移転できないものとします。

上記を遵守頂けない場合は、電波法の罰則が適用される可能性があることをご留意ください。日本テキサス・インスツルメンツ株式会社
東京都新宿区西新宿 6 丁目 2 4 番 1 号
西新宿三井ビル

3.3.3 *Notice for EVMs for Power Line Communication:* Please see http://www.tij.co.jp/llds/ti_ja/general/eStore/notice_02.page
電力線搬送波通信についての開発キットをお使いになる際の注意事項については、次のところをご覧ください。http://www.tij.co.jp/llds/ti_ja/general/eStore/notice_02.page

4 *EVM Use Restrictions and Warnings:*

4.1 EVMS ARE NOT FOR USE IN FUNCTIONAL SAFETY AND/OR SAFETY CRITICAL EVALUATIONS, INCLUDING BUT NOT LIMITED TO EVALUATIONS OF LIFE SUPPORT APPLICATIONS.

4.2 User must read and apply the user guide and other available documentation provided by TI regarding the EVM prior to handling or using the EVM, including without limitation any warning or restriction notices. The notices contain important safety information related to, for example, temperatures and voltages.

4.3 *Safety-Related Warnings and Restrictions:*

4.3.1 User shall operate the EVM within TI's recommended specifications and environmental considerations stated in the user guide, other available documentation provided by TI, and any other applicable requirements and employ reasonable and customary safeguards. Exceeding the specified performance ratings and specifications (including but not limited to input and output voltage, current, power, and environmental ranges) for the EVM may cause personal injury or death, or property damage. If there are questions concerning performance ratings and specifications, User should contact a TI field representative prior to connecting interface electronics including input power and intended loads. Any loads applied outside of the specified output range may also result in unintended and/or inaccurate operation and/or possible permanent damage to the EVM and/or interface electronics. Please consult the EVM user guide prior to connecting any load to the EVM output. If there is uncertainty as to the load specification, please contact a TI field representative. During normal operation, even with the inputs and outputs kept within the specified allowable ranges, some circuit components may have elevated case temperatures. These components include but are not limited to linear regulators, switching transistors, pass transistors, current sense resistors, and heat sinks, which can be identified using the information in the associated documentation. When working with the EVM, please be aware that the EVM may become very warm.

4.3.2 EVMs are intended solely for use by technically qualified, professional electronics experts who are familiar with the dangers and application risks associated with handling electrical mechanical components, systems, and subsystems. User assumes all responsibility and liability for proper and safe handling and use of the EVM by User or its employees, affiliates, contractors or designees. User assumes all responsibility and liability to ensure that any interfaces (electronic and/or mechanical) between the EVM and any human body are designed with suitable isolation and means to safely limit accessible leakage currents to minimize the risk of electrical shock hazard. User assumes all responsibility and liability for any improper or unsafe handling or use of the EVM by User or its employees, affiliates, contractors or designees.

4.4 User assumes all responsibility and liability to determine whether the EVM is subject to any applicable international, federal, state, or local laws and regulations related to User's handling and use of the EVM and, if applicable, User assumes all responsibility and liability for compliance in all respects with such laws and regulations. User assumes all responsibility and liability for proper disposal and recycling of the EVM consistent with all applicable international, federal, state, and local requirements.

5. *Accuracy of Information:* To the extent TI provides information on the availability and function of EVMs, TI attempts to be as accurate as possible. However, TI does not warrant the accuracy of EVM descriptions, EVM availability or other information on its websites as accurate, complete, reliable, current, or error-free.

6. *Disclaimers:*
- 6.1 EXCEPT AS SET FORTH ABOVE, EVMS AND ANY WRITTEN DESIGN MATERIALS PROVIDED WITH THE EVM (AND THE DESIGN OF THE EVM ITSELF) ARE PROVIDED "AS IS" AND "WITH ALL FAULTS." TI DISCLAIMS ALL OTHER WARRANTIES, EXPRESS OR IMPLIED, REGARDING SUCH ITEMS, INCLUDING BUT NOT LIMITED TO ANY IMPLIED WARRANTIES OF MERCHANTABILITY OR FITNESS FOR A PARTICULAR PURPOSE OR NON-INFRINGEMENT OF ANY THIRD PARTY PATENTS, COPYRIGHTS, TRADE SECRETS OR OTHER INTELLECTUAL PROPERTY RIGHTS.
- 6.2 EXCEPT FOR THE LIMITED RIGHT TO USE THE EVM SET FORTH HEREIN, NOTHING IN THESE TERMS AND CONDITIONS SHALL BE CONSTRUED AS GRANTING OR CONFERRING ANY RIGHTS BY LICENSE, PATENT, OR ANY OTHER INDUSTRIAL OR INTELLECTUAL PROPERTY RIGHT OF TI, ITS SUPPLIERS/LICENSORS OR ANY OTHER THIRD PARTY, TO USE THE EVM IN ANY FINISHED END-USER OR READY-TO-USE FINAL PRODUCT, OR FOR ANY INVENTION, DISCOVERY OR IMPROVEMENT MADE, CONCEIVED OR ACQUIRED PRIOR TO OR AFTER DELIVERY OF THE EVM.
7. *USER'S INDEMNITY OBLIGATIONS AND REPRESENTATIONS.* USER WILL DEFEND, INDEMNIFY AND HOLD TI, ITS LICENSORS AND THEIR REPRESENTATIVES HARMLESS FROM AND AGAINST ANY AND ALL CLAIMS, DAMAGES, LOSSES, EXPENSES, COSTS AND LIABILITIES (COLLECTIVELY, "CLAIMS") ARISING OUT OF OR IN CONNECTION WITH ANY HANDLING OR USE OF THE EVM THAT IS NOT IN ACCORDANCE WITH THESE TERMS AND CONDITIONS. THIS OBLIGATION SHALL APPLY WHETHER CLAIMS ARISE UNDER STATUTE, REGULATION, OR THE LAW OF TORT, CONTRACT OR ANY OTHER LEGAL THEORY, AND EVEN IF THE EVM FAILS TO PERFORM AS DESCRIBED OR EXPECTED.
8. *Limitations on Damages and Liability:*
- 8.1 *General Limitations.* IN NO EVENT SHALL TI BE LIABLE FOR ANY SPECIAL, COLLATERAL, INDIRECT, PUNITIVE, INCIDENTAL, CONSEQUENTIAL, OR EXEMPLARY DAMAGES IN CONNECTION WITH OR ARISING OUT OF THESE TERMS AND CONDITIONS OR THE USE OF THE EVMS PROVIDED HEREUNDER, REGARDLESS OF WHETHER TI HAS BEEN ADVISED OF THE POSSIBILITY OF SUCH DAMAGES. EXCLUDED DAMAGES INCLUDE, BUT ARE NOT LIMITED TO, COST OF REMOVAL OR REINSTALLATION, ANCILLARY COSTS TO THE PROCUREMENT OF SUBSTITUTE GOODS OR SERVICES, RETESTING, OUTSIDE COMPUTER TIME, LABOR COSTS, LOSS OF GOODWILL, LOSS OF PROFITS, LOSS OF SAVINGS, LOSS OF USE, LOSS OF DATA, OR BUSINESS INTERRUPTION. NO CLAIM, SUIT OR ACTION SHALL BE BROUGHT AGAINST TI MORE THAN ONE YEAR AFTER THE RELATED CAUSE OF ACTION HAS OCCURRED.
- 8.2 *Specific Limitations.* IN NO EVENT SHALL TI'S AGGREGATE LIABILITY FROM ANY WARRANTY OR OTHER OBLIGATION ARISING OUT OF OR IN CONNECTION WITH THESE TERMS AND CONDITIONS, OR ANY USE OF ANY TI EVM PROVIDED HEREUNDER, EXCEED THE TOTAL AMOUNT PAID TO TI FOR THE PARTICULAR UNITS SOLD UNDER THESE TERMS AND CONDITIONS WITH RESPECT TO WHICH LOSSES OR DAMAGES ARE CLAIMED. THE EXISTENCE OF MORE THAN ONE CLAIM AGAINST THE PARTICULAR UNITS SOLD TO USER UNDER THESE TERMS AND CONDITIONS SHALL NOT ENLARGE OR EXTEND THIS LIMIT.
9. *Return Policy.* Except as otherwise provided, TI does not offer any refunds, returns, or exchanges. Furthermore, no return of EVM(s) will be accepted if the package has been opened and no return of the EVM(s) will be accepted if they are damaged or otherwise not in a resalable condition. If User feels it has been incorrectly charged for the EVM(s) it ordered or that delivery violates the applicable order, User should contact TI. All refunds will be made in full within thirty (30) working days from the return of the components(s), excluding any postage or packaging costs.
10. *Governing Law:* These terms and conditions shall be governed by and interpreted in accordance with the laws of the State of Texas, without reference to conflict-of-laws principles. User agrees that non-exclusive jurisdiction for any dispute arising out of or relating to these terms and conditions lies within courts located in the State of Texas and consents to venue in Dallas County, Texas. Notwithstanding the foregoing, any judgment may be enforced in any United States or foreign court, and TI may seek injunctive relief in any United States or foreign court.

Mailing Address: Texas Instruments, Post Office Box 655303, Dallas, Texas 75265
Copyright © 2015, Texas Instruments Incorporated

IMPORTANT NOTICE

Texas Instruments Incorporated and its subsidiaries (TI) reserve the right to make corrections, enhancements, improvements and other changes to its semiconductor products and services per JESD46, latest issue, and to discontinue any product or service per JESD48, latest issue. Buyers should obtain the latest relevant information before placing orders and should verify that such information is current and complete. All semiconductor products (also referred to herein as "components") are sold subject to TI's terms and conditions of sale supplied at the time of order acknowledgment.

TI warrants performance of its components to the specifications applicable at the time of sale, in accordance with the warranty in TI's terms and conditions of sale of semiconductor products. Testing and other quality control techniques are used to the extent TI deems necessary to support this warranty. Except where mandated by applicable law, testing of all parameters of each component is not necessarily performed.

TI assumes no liability for applications assistance or the design of Buyers' products. Buyers are responsible for their products and applications using TI components. To minimize the risks associated with Buyers' products and applications, Buyers should provide adequate design and operating safeguards.

TI does not warrant or represent that any license, either express or implied, is granted under any patent right, copyright, mask work right, or other intellectual property right relating to any combination, machine, or process in which TI components or services are used. Information published by TI regarding third-party products or services does not constitute a license to use such products or services or a warranty or endorsement thereof. Use of such information may require a license from a third party under the patents or other intellectual property of the third party, or a license from TI under the patents or other intellectual property of TI.

Reproduction of significant portions of TI information in TI data books or data sheets is permissible only if reproduction is without alteration and is accompanied by all associated warranties, conditions, limitations, and notices. TI is not responsible or liable for such altered documentation. Information of third parties may be subject to additional restrictions.

Resale of TI components or services with statements different from or beyond the parameters stated by TI for that component or service voids all express and any implied warranties for the associated TI component or service and is an unfair and deceptive business practice. TI is not responsible or liable for any such statements.

Buyer acknowledges and agrees that it is solely responsible for compliance with all legal, regulatory and safety-related requirements concerning its products, and any use of TI components in its applications, notwithstanding any applications-related information or support that may be provided by TI. Buyer represents and agrees that it has all the necessary expertise to create and implement safeguards which anticipate dangerous consequences of failures, monitor failures and their consequences, lessen the likelihood of failures that might cause harm and take appropriate remedial actions. Buyer will fully indemnify TI and its representatives against any damages arising out of the use of any TI components in safety-critical applications.

In some cases, TI components may be promoted specifically to facilitate safety-related applications. With such components, TI's goal is to help enable customers to design and create their own end-product solutions that meet applicable functional safety standards and requirements. Nonetheless, such components are subject to these terms.

No TI components are authorized for use in FDA Class III (or similar life-critical medical equipment) unless authorized officers of the parties have executed a special agreement specifically governing such use.

Only those TI components which TI has specifically designated as military grade or "enhanced plastic" are designed and intended for use in military/aerospace applications or environments. Buyer acknowledges and agrees that any military or aerospace use of TI components which have **not** been so designated is solely at the Buyer's risk, and that Buyer is solely responsible for compliance with all legal and regulatory requirements in connection with such use.

TI has specifically designated certain components as meeting ISO/TS16949 requirements, mainly for automotive use. In any case of use of non-designated products, TI will not be responsible for any failure to meet ISO/TS16949.

Products

Audio	www.ti.com/audio
Amplifiers	amplifier.ti.com
Data Converters	dataconverter.ti.com
DLP® Products	www.dlp.com
DSP	dsp.ti.com
Clocks and Timers	www.ti.com/clocks
Interface	interface.ti.com
Logic	logic.ti.com
Power Mgmt	power.ti.com
Microcontrollers	microcontroller.ti.com
RFID	www.ti-rfid.com
OMAP Applications Processors	www.ti.com/omap
Wireless Connectivity	www.ti.com/wirelessconnectivity

Applications

Automotive and Transportation	www.ti.com/automotive
Communications and Telecom	www.ti.com/communications
Computers and Peripherals	www.ti.com/computers
Consumer Electronics	www.ti.com/consumer-apps
Energy and Lighting	www.ti.com/energy
Industrial	www.ti.com/industrial
Medical	www.ti.com/medical
Security	www.ti.com/security
Space, Avionics and Defense	www.ti.com/space-avionics-defense
Video and Imaging	www.ti.com/video

TI E2E Community

e2e.ti.com