



Bergische Universität Wuppertal

Fachbereich Mathematik und Naturwissenschaften

Lehrstuhl für Angewandte Mathematik
und Numerische Mathematik

Preprint BUW-AMNA 09/01

Roland Pulch

**Polynomial chaos expansions for analysing
oscillators with uncertainties**

January 2009

<http://www-num.math.uni-wuppertal.de>

Polynomial Chaos Expansions for Analysing Oscillators with Uncertainties

Roland Pulch

Bergische Universität Wuppertal, Fachbereich Mathematik und
Naturwissenschaften, Lehrstuhl für Angewandte Mathematik und Numerische
Mathematik, Gaußstr. 20, D-42119 Wuppertal, Germany.
Email: pulch@math.uni-wuppertal.de

Abstract

Mathematical modelling of dynamical processes often yields systems of ordinary differential equations (ODEs) or differential algebraic equations (DAEs). Physical parameters of the systems may exhibit uncertainties. We replace these parameters by random variables and thus the solution becomes a random process. To resolve the stochastic model, quasi Monte-Carlo methods or related techniques can be employed, which often demand a huge computational work. Alternatively, we apply the strategy of the generalised polynomial chaos, where a Galerkin approach yields a larger coupled system of ODEs or DAEs. We focus on autonomous oscillators, where periodic boundary value problems with a priori unknown periods are considered. Numerical methods to solve the coupled systems including additional conditions are constructed. Furthermore, we discuss the local stability of the periodic solutions in the stochastic model. Results of numerical simulations are presented.

1 Introduction

Systems of ordinary differential equations (ODEs) or differential algebraic equations (DAEs) appear in many applications like electric circuit simulation, mechanical engineering or chemical reaction kinetics, for example. The systems include physical parameters, which may exhibit uncertainties. Consequently, we replace

the according parameters by random variables. The solution of the ODEs or DAEs becomes a random process. The stochastic model can be resolved by quasi Monte-Carlo methods or related techniques. However, the required simulations often cause a huge computational effort.

Alternatively, we apply the generalised polynomial chaos (gPC) to solve the stochastic model, see [1, 2, 14]. Thereby, the time- and random-dependent solution is expanded in a series with orthogonal basis polynomials, which depend on the probability space only. Two approaches can be used to determine the unknown time-dependent coefficient functions, see [15, 16, 17]. Firstly, the stochastic collocation computes the coefficient functions like in a quasi Monte-Carlo simulation or a multidimensional quadrature. Secondly, a Galerkin method yields a larger coupled system of ODEs or DAEs for the coefficient functions. Each approach has advantages and disadvantages. We discuss the Galerkin technique in this article.

We consider oscillators with uncertainties, i.e., periodic problems of ODEs or DAEs. Random oscillators with ODE models have been simulated via the gPC approach in [7, 8]. An initial value problem of DAEs corresponding to a forced oscillator is used for gPC simulations in [9]. The gPC is applied to forced oscillators described by boundary value problems of DAEs in [10, 11], where the Galerkin method generates a non-autonomous coupled system. We focus on autonomous oscillators within this article. The period of a corresponding solution is unknown a priori in this case. Sophisticated techniques determine a periodic solution and its rate, see [3]. In case of random parameters, the solution as well as the period are expanded in the gPC. The Galerkin method results in an autonomous system for the unknown coefficients.

The local stability of a periodic solution represents a crucial information, see [12]. In technical applications, stable periodic states are desired. We assume that the periodic solutions are stable for all involved parameters. In case of systems of ODEs, the local stability can be analysed by the eigenvalues of the monodromy matrix, which satisfies an initial value problem of a linear matrix differential equation. Generalisations of this concept to systems of DAEs are feasible, cf. [5, 6]. Since we determine a periodic solution of the coupled system in the gPC approach, an analysis of local stability can be done. We derive the matrix differential equation in case of the coupled system, where the coefficient matrix exhibits a specific structure with minors.

Finally, we perform numerical simulations, where the electric circuit of a Colpitt oscillator is considered. A mathematical model yields an implicit system of ODEs for the transient behaviour of the node voltages, see [4]. We introduce a random parameter and solve a periodic problem of the corresponding coupled system in the gPC approach. Moreover, the eigenvalues of the monodromy matrix are

computed for different magnitudes of the random parameter to illustrate the local stability of the periodic solutions.

The article is organised as follows. In Section 2, we introduce the model of an autonomous oscillator based on DAEs, where ODEs represent a special case. The gPC approach followed by the Galerkin method is applied in Section 3. We discuss the analysis of the local stability for periodic solutions in Section 4. The results of the numerical simulations are presented in Section 5.

2 Problem Definition

We consider an implicit system of ODEs or a system of DAEs, which includes physical parameters $\mathbf{p} \in Q$ for some relevant set $Q \subseteq \mathbb{R}^q$. The system reads

$$A(\mathbf{p})\dot{\mathbf{x}}(t, \mathbf{p}) = \mathbf{f}(t, \mathbf{x}(t, \mathbf{p}), \mathbf{p}) \quad (1)$$

with parameter-dependent solution $\mathbf{x} : [t_0, t_1] \times Q \rightarrow \mathbb{R}^n$. If the square matrix $A(\mathbf{p}) \in \mathbb{R}^{n \times n}$ is singular, then the system (1) represents DAEs. Alternatively, a regular matrix implies implicit systems of ODEs. In the system (1), the right-hand side $\mathbf{f} : [t_0, t_1] \times \mathbb{R}^n \times Q \rightarrow \mathbb{R}^n$ can include time-dependent input signals. Otherwise, the system (1) becomes autonomous, i.e.,

$$A(\mathbf{p})\dot{\mathbf{x}}(t, \mathbf{p}) = \mathbf{f}(\mathbf{x}(t, \mathbf{p}), \mathbf{p}) \quad (2)$$

with right-hand side $\mathbf{f} : \mathbb{R}^n \times Q \rightarrow \mathbb{R}^n$. Given a solution \mathbf{x} of the system (2), the translated function

$$\mathbf{y}_\theta(t) := \mathbf{x}(t + \theta) \quad \text{with } \theta \in \mathbb{R} \quad (3)$$

also represents a solution of the system (2).

We investigate oscillators, i.e., periodic boundary value problems of the systems (1) or (2) have to be solved. The periodicity condition reads

$$\mathbf{x}(t + T(\mathbf{p}), \mathbf{p}) = \mathbf{x}(t, \mathbf{p}) \quad \text{for all } t \text{ and each } \mathbf{p} \in Q \quad (4)$$

with the periods $T(\mathbf{p}) > 0$. For non-autonomous systems (1), a constant period $T(\mathbf{p}) \equiv T_0$ occurs, where the rate T_0 is known from input signals in the right-hand side \mathbf{f} . In case of autonomous oscillators (2), the period depends on the parameters and is unknown a priori. Remark that the translation (3) of a periodic solution is again a periodic solution of the system (2). We use a standardisation via $\tilde{\mathbf{x}}(\tau) := \mathbf{x}(\tau T(\mathbf{p}), \mathbf{p})$ and obtain the equivalent system

$$A(\mathbf{p})\dot{\tilde{\mathbf{x}}}(\tau, \mathbf{p}) = T(\mathbf{p})\mathbf{f}(\tilde{\mathbf{x}}(\tau, \mathbf{p}), \mathbf{p}). \quad (5)$$

The corresponding periodicity condition is

$$\tilde{\mathbf{x}}(\tau + 1, \mathbf{p}) = \tilde{\mathbf{x}}(\tau, \mathbf{p}) \quad \text{for all } \tau \text{ and each } \mathbf{p} \in Q, \quad (6)$$

which is equivalent to the two-point boundary value problem

$$\tilde{\mathbf{x}}(0, \mathbf{p}) = \tilde{\mathbf{x}}(1, \mathbf{p}) \quad \text{for each } \mathbf{p} \in Q \quad (7)$$

provided that initial value problems of (5) exhibit a unique solution.

The boundary value problem (5),(7) is underdetermined, since the period $T(\mathbf{p})$ is unknown a priori. Thus we have to specify an additional condition to obtain an isolated solution. Popular choices are phase conditions, which produce additional boundary conditions, see [3, 12]. Without loss of generality, we consider the first component of the solution $\tilde{\mathbf{x}} = (\tilde{x}_1, \dots, \tilde{x}_n)^\top$. For example, we demand

$$\tilde{x}_1(0, \mathbf{p}) = \eta(\mathbf{p}) \quad (8)$$

using $\eta(\mathbf{p}) \in \mathbb{R}$ from the range of this component. Although the value $\eta(\mathbf{p})$ may depend on the parameter, a constant choice $\eta(\mathbf{p}) \equiv \eta_0$ is often feasible for all parameters. An alternative phase condition is

$$0 = \dot{\tilde{x}}_1(0, \mathbf{p}) = T(\mathbf{p})f_1(\tilde{\mathbf{x}}(0, \mathbf{p}), \mathbf{p}), \quad (9)$$

which implies a local optimum or a saddle point at the boundary $\tau = 0$.

We assume that the chosen parameters exhibit some uncertainties. Consequently, we substitute the parameters by independent random variables

$$\mathbf{p} : \Omega \rightarrow Q, \quad \mathbf{p} = (p_1(\omega), \dots, p_q(\omega))^\top \quad (10)$$

with respect to some probability space $(\Omega, \mathcal{A}, \mu)$. Let each p_j exhibit a classical distribution like Gaussian, uniform, beta, etc. Hence a joint probability density function $\rho : \mathbb{R}^q \rightarrow \mathbb{R}$ exists. Given a function $f : \mathbb{R}^q \rightarrow \mathbb{R}$, which depends on the parameters, the expected value reads (if exists)

$$\langle f(\mathbf{p}) \rangle := \int_{\Omega} f(\mathbf{p}(\omega)) \, d\mu(\omega) = \int_{\mathbb{R}^q} f(\mathbf{p}) \rho(\mathbf{p}) \, d\mathbf{p}. \quad (11)$$

The expected value implies an inner product with respect to $L^2(\Omega)$ via

$$\langle f(\mathbf{p})g(\mathbf{p}) \rangle = \int_{\mathbb{R}^q} f(\mathbf{p})g(\mathbf{p})\rho(\mathbf{p}) \, d\mathbf{p} \quad (12)$$

for functions $f, g \in L^2(\Omega)$ depending on the parameters. We apply the expected value (11) and the inner product (12) also to vector-valued and matrix-valued functions by components.

The solution of (1), (2) or (5), respectively, depends on the probability space now. In case of the system (5), we obtain the random process $\tilde{\mathbf{x}} : [\tau_0, \tau_1] \times \Omega \rightarrow \mathbb{R}^n$ and $T : \Omega \rightarrow \mathbb{R}$ represents a random variable. We are interested in the expected value, the variance or more sophisticated properties of the stochastic solution. Quasi Monte-Carlo methods or more efficient variants can be applied to resolve the stochastic model. However, the computational effort often becomes large.

3 Generalised Polynomial Chaos

Assuming finite second moments of the random process, the expansions of the gPC exist, see [1, 14]. The random process satisfying the system (5) exhibits the representation

$$\tilde{\mathbf{x}}(\tau, \mathbf{p}(\omega)) = \sum_{i=0}^{\infty} \mathbf{v}_i(\tau) \Phi_i(\mathbf{p}(\omega)). \quad (13)$$

The coefficient functions $\mathbf{v}_i : [\tau_0, \tau_1] \rightarrow \mathbb{R}^n$ are unknown a priori. The functions $\Phi_i : \mathbb{R}^q \rightarrow \mathbb{R}$ represent a complete basis of multivariate polynomials. The polynomial chaos applies an orthogonal basis with respect to the inner product (12), i.e., it holds $\langle \Phi_i, \Phi_j \rangle = \delta_{ij}$ with the Kronecker-delta. Table 1 mentions the types of basis polynomials for some classical random distributions. In case of the Gaussian distribution, the technique is called the polynomial chaos. In case of other random distributions, the approach is called the generalised polynomial chaos. The series (13) converges in the space $L^2(\Omega)$ for fixed t .

Accordingly, we assume a finite second moment of the random period. It follows the expansion

$$T(\mathbf{p}(\omega)) = \sum_{j=0}^{\infty} w_j \Phi_j(\mathbf{p}(\omega)) \quad (14)$$

with coefficients $w_j \in \mathbb{R}$ and the same basis polynomials $(\Phi_j)_{j \in \mathbb{N}}$ as in (13).

To achieve a numerical method, the infinite sums (13) and (14) are truncated at the m th and m' th term, respectively, which implies approximations

$$\tilde{\mathbf{x}}^m(\tau, \mathbf{p}(\omega)) = \sum_{i=0}^m \mathbf{v}_i(\tau) \Phi_i(\mathbf{p}(\omega)), \quad T^{m'}(\mathbf{p}(\omega)) = \sum_{j=0}^{m'} w_j \Phi_j(\mathbf{p}(\omega)). \quad (15)$$

Approximations of the involved coefficients \mathbf{v}_i, w_j can be determined either by stochastic collocation or a Galerkin approach, see [16, 17]. We apply the Galerkin approach, i.e., the residual has to be orthogonal to the space of the used basis polynomials Φ_0, \dots, Φ_m . Inserting the finite sums (15) in the system (5), the

residual becomes

$$\begin{aligned} \mathbf{r}(t, \mathbf{p}(\omega)) &:= A(\mathbf{p}(\omega)) \left(\sum_{i=0}^m \dot{\mathbf{v}}_i(\tau) \Phi_i(\mathbf{p}(\omega)) \right) \\ &\quad - \left(\sum_{j=0}^{m'} w_j \Phi_j(\mathbf{p}(\omega)) \right) \mathbf{f} \left(\sum_{i=0}^m \mathbf{v}_i(\tau) \Phi_i(\mathbf{p}(\omega)), \mathbf{p}(\omega) \right). \end{aligned} \quad (16)$$

The Galerkin method implies the larger coupled system

$$\sum_{i=0}^m \langle \Phi_l(\mathbf{p}) \Phi_i(\mathbf{p}) A(\mathbf{p}) \rangle \dot{\mathbf{v}}_i(\tau) = \left\langle \Phi_l(\mathbf{p}) \left(\sum_{j=0}^{m'} w_j \Phi_j(\mathbf{p}) \right) \mathbf{f} \left(\sum_{i=0}^m \mathbf{v}_i(\tau) \Phi_i(\mathbf{p}), \mathbf{p} \right) \right\rangle$$

for $l = 0, 1, \dots, m$ with the coefficients \mathbf{v}_i, w_j as unknowns. We rewrite the above system into

$$\sum_{i=0}^m \langle \Phi_l(\mathbf{p}) \Phi_i(\mathbf{p}) A(\mathbf{p}) \rangle \dot{\mathbf{v}}_i(\tau) = \sum_{j=0}^{m'} w_j \left\langle \Phi_l(\mathbf{p}) \Phi_j(\mathbf{p}) \mathbf{f} \left(\sum_{i=0}^m \mathbf{v}_i(\tau) \Phi_i(\mathbf{p}), \mathbf{p} \right) \right\rangle \quad (17)$$

for $l = 0, 1, \dots, m$. The exact coefficient functions of the random process (13) satisfy the relation

$$\mathbf{v}_i(\tau) = \langle \tilde{\mathbf{x}}(\tau, \mathbf{p}) \Phi_i(\mathbf{p}) \rangle \quad \text{for each } i \in \mathbb{N}. \quad (18)$$

Hence the coefficient functions inherit the periodicity of the random process. We apply the boundary conditions

$$\mathbf{v}_i(0) = \mathbf{v}_i(1) \quad \text{for } i = 0, 1, \dots, m \quad (19)$$

to the system (17). Remark that a solution of the boundary value problem (17),(19) represents just an approximation of the exact coefficients in (13).

If the matrix $A(\mathbf{p})$ does not depend on the parameters, i.e., $A(\mathbf{p}) \equiv A_0$, then the system (17) simplifies to

$$A_0 \dot{\mathbf{v}}_l(\tau) = \sum_{j=0}^{m'} w_j \left\langle \Phi_l(\mathbf{p}) \Phi_j(\mathbf{p}) \mathbf{f} \left(\sum_{i=0}^m \mathbf{v}_i(\tau) \Phi_i(\mathbf{p}), \mathbf{p} \right) \right\rangle \quad (20)$$

for $l = 0, 1, \dots, m$ due to the orthonormal basis polynomials.

If the nonlinear function \mathbf{f} does not depend explicitly on the parameters, whereas the matrix A includes parameters, then the system is not significantly simplified, i.e., for $l = 0, 1, \dots, m$

$$\sum_{i=0}^m \langle \Phi_i(\mathbf{p}) \Phi_l(\mathbf{p}) A(\mathbf{p}) \rangle \dot{\mathbf{v}}_i(t) = \sum_{j=0}^{m'} w_j \left\langle \Phi_j(\mathbf{p}) \Phi_l(\mathbf{p}) \mathbf{f} \left(\sum_{i=0}^m \mathbf{v}_i(t) \Phi_i(\mathbf{p}) \right) \right\rangle. \quad (21)$$

We have achieved a system of $(m+1)n$ ODEs or DAEs, respectively. However, the coupled system includes $(m+1)n$ unknown functions \mathbf{v}_i as well as $m'+1$ unknown values w_j . Thus we need $m'+1$ additional conditions to specify a solution. For this purpose, a phase condition can be expanded in the polynomial chaos. Firstly, the condition (8) yields the additional relations ($\mathbf{v}_i = (v_{i,1}, \dots, v_{i,n})^\top$)

$$v_{i,1}(0) = \langle \eta(\mathbf{p}) \Phi_i(\mathbf{p}) \rangle \quad \text{for } i = 0, 1, \dots, m'. \quad (22)$$

In the special case $\eta(\mathbf{p}) \equiv \eta_0$, we obtain

$$v_{0,1}(0) = \eta_0, \quad v_{i,1}(0) = 0 \quad \text{for } i = 1, \dots, m'. \quad (23)$$

Secondly, the phase condition (9) leads to the additional conditions

$$\left\langle \Phi_j(\mathbf{p}) f_1 \left(\sum_{i=0}^m \mathbf{v}_i(0) \Phi_i(\mathbf{p}), \mathbf{p} \right) \right\rangle = 0 \quad \text{for } j = 0, 1, \dots, m'. \quad (24)$$

In both cases, $m'+1$ boundary conditions are given to solve a two-point boundary value problem (17),(19). Common numerical schemes to tackle periodic boundary value problems are, cf. [3, 13],

1. finite difference methods (time domain),
2. (multiple) shooting methods (time domain),
3. harmonic balance (frequency domain).

These techniques can be modified such that they include the additional conditions.

In each evaluation of the right-hand side of (17), an expected value (11) has to be computed for each component. We obtain an approximation via Gaussian quadrature with respect to the underlying probability density function. If the function \mathbf{f} does not depend on the parameters and represents a polynomial, then the order of the quadrature can be chosen sufficiently high such that the approximation becomes exact.

If a numerical solution (15) has been computed, then we achieve an approximation of the solution of the original system (2) via the transformation

$$\mathbf{x}^m(t, \mathbf{p}(\omega)) \doteq \tilde{\mathbf{x}}^m \left(\frac{t}{T^{m'}(\mathbf{p}(\omega))}, \mathbf{p}(\omega) \right). \quad (25)$$

Furthermore, we comment on the Galerkin approach in comparison to stochastic collocation in case of boundary value problems. On the one hand, the technique

Table 1: Orthogonal basis polynomials for classical random distributions (univariate case).

distribution	basis polynomials	support	density function
Gaussian	Hermite	$(-\infty, +\infty)$	$\rho(x) \sim \exp(-\frac{1}{2}x^2)$
gamma	Laguerre	$[0, +\infty)$	$\rho(x) \sim x^{p-1} \exp(-cx)$
beta	Jacobi	$[a, b]$	$\rho(x) \sim (x-a)^{p-1}(b-x)^{q-1}$
uniform	Legendre	$[a, b]$	$\rho(x) \sim 1$

of the stochastic collocation is similar to a quasi Monte-Carlo method or a multidimensional quadrature. Thus realisations $\mathbf{p}^1, \dots, \mathbf{p}^K$ of the parameters are chosen, where the number K is often large. For each realisation \mathbf{p}^j , a boundary value problem of the system (2) or (5), respectively, has to be solved to obtain a periodic solution. Newton iterations yield numerical solutions of corresponding nonlinear systems. Hence we have to guarantee the convergence of a large number of Newton methods. Sophisticated algorithms are required to generate appropriate starting values for the iteration in each nonlinear system. On the other hand, the Galerkin approach yields just one boundary value problem of the large coupled system (17). Thus we have to control the convergence of a single Newton iteration only. To evaluate the right-hand side of the system (17), expected values (11) are computed. For a general nonlinear function \mathbf{f} , multidimensional quadrature yields approximations using a large number of grid points $\mathbf{p}^1, \dots, \mathbf{p}^K$ of the parameters again. Nevertheless, no nonlinear systems have to be solved to evaluate the right-hand side of (17). This advantage of the Galerkin approach holds for boundary value problems of systems of differential equations in general.

4 Analysis of Local Stability

In this section, we discuss the local stability of the periodic solutions. Thereby, we consider the case of ODEs, i.e., it holds $A(\mathbf{p}) \equiv I_n$ and the parameters are included in the right-hand side \mathbf{f} only. A system of implicit ODEs is equivalent to this situation. The local stability of a periodic solution of ODEs is determined by the eigenvalues of the monodromy matrix, see [12]. Generalisations of this stability analysis to systems of DAEs are given in [5, 6]. Let \mathbf{x} be a periodic solution of the system (1) with rate $T(\mathbf{p})$ in case of ODEs. The time- and parameter-dependent matrix $M : \mathbb{R} \times Q \rightarrow \mathbb{R}^{n \times n}$ satisfies the initial value problem of a

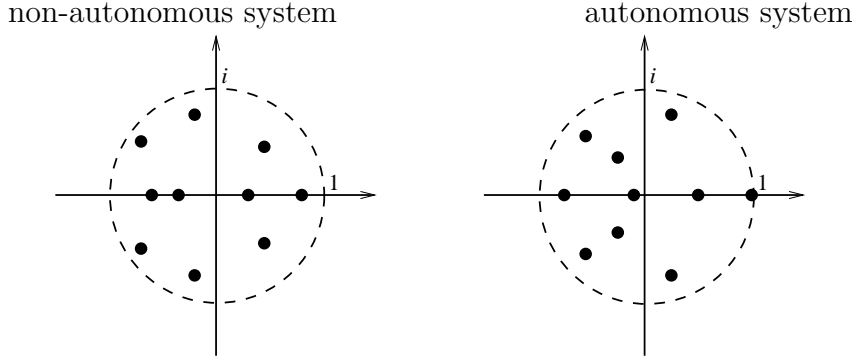

Figure 1: Location of the eigenvalues of the monodromy matrix in the case of a stable periodic solution.

matrix differential equation

$$\dot{M}(t, \mathbf{p}) = \frac{\partial \mathbf{f}}{\partial \mathbf{x}}(t, \mathbf{x}(t, \mathbf{p}), \mathbf{p}) M(t, \mathbf{p}), \quad M(0, \mathbf{p}) = I_n, \quad (26)$$

where $\frac{\partial \mathbf{f}}{\partial \mathbf{x}} \in \mathbb{R}^{n \times n}$ represents the Jacobian matrix of \mathbf{f} with respect to \mathbf{x} . The monodromy matrix corresponding to the periodic solution is $M(T(\mathbf{p}), \mathbf{p})$. Let $\lambda_1, \dots, \lambda_n \in \mathbb{C}$ be the eigenvalues of the monodromy matrix. The periodic solution is locally stable if and only if $|\lambda_j| < 1$ holds for all j . Figure 1 illustrates this situation.

Now let \mathbf{x} be a solution of the autonomous system (2). The matrix differential equation (26) just changes into

$$\dot{M}(t, \mathbf{p}) = \frac{\partial \mathbf{f}}{\partial \mathbf{x}}(\mathbf{x}(t, \mathbf{p}), \mathbf{p}) M(t, \mathbf{p}), \quad M(0, \mathbf{p}) = I_n. \quad (27)$$

The monodromy matrix $M(T(\mathbf{p}), \mathbf{p})$ exhibits one eigenvalue $\lambda = 1$, which reflects that a translation (3) of a periodic solution is still a solution of the autonomous system (2). The periodic solution is locally stable if and only if $|\lambda_j| < 1$ holds for all $j = 2, \dots, n$. This stable case is also shown in Figure 1.

We can also apply the standardised system (5). We define the transformed matrix $\tilde{M}(\tau, \mathbf{p}) := M(\tau T(\mathbf{p}), \mathbf{p})$. The corresponding matrix differential equation reads

$$\dot{\tilde{M}}(\tau, \mathbf{p}) = T(\mathbf{p}) \frac{\partial \mathbf{f}}{\partial \tilde{\mathbf{x}}}(\tilde{\mathbf{x}}(\tau, \mathbf{p}), \mathbf{p}) \tilde{M}(\tau, \mathbf{p}), \quad \tilde{M}(0, \mathbf{p}) = I_n. \quad (28)$$

The monodromy matrix is $\tilde{M}(1, \mathbf{p}) = M(T(\mathbf{p}), \mathbf{p})$.

We analyse the system (20) from the gPC approach in case of $A_0 = I_n$. Let $\mathbf{v} := (\mathbf{v}_0^\top, \dots, \mathbf{v}_m^\top)^\top$ be a solution of (20) with periodicity (19) for fixed values

$w_0, \dots, w_{m'}$. To determine the monodromy matrix, the corresponding matrix differential equation exhibits the form

$$\dot{N}(\tau) = B(\tau)N(\tau), \quad N(0) = I_{(m+1)n} \quad (29)$$

with $N, B : \mathbb{R} \rightarrow \mathbb{R}^{(m+1)n \times (m+1)n}$. The solution $N(1)$ represents the monodromy matrix, which determines the stability of the periodic solution \mathbf{v} . Investigating $B = (B_{ij})$, the minors $B_{ij} \in \mathbb{R}^{n \times n}$ for $i, j = 0, 1, \dots, m$ are calculated as follows

$$\begin{aligned} B_{ij}(\tau) &= \frac{\partial}{\partial \mathbf{v}_j} \left[\sum_{k=0}^{m'} w_k \left\langle \Phi_i(\mathbf{p}) \Phi_k(\mathbf{p}) \mathbf{f} \left(\sum_{l=0}^m \mathbf{v}_l(\tau) \Phi_l(\mathbf{p}), \mathbf{p} \right) \right\rangle \right] \\ &= \sum_{k=0}^{m'} w_k \left\langle \Phi_i(\mathbf{p}) \Phi_k(\mathbf{p}) \frac{\partial}{\partial \mathbf{v}_j} \left[\mathbf{f} \left(\sum_{l=0}^m \mathbf{v}_l(\tau) \Phi_l(\mathbf{p}), \mathbf{p} \right) \right] \right\rangle \\ &= \sum_{k=0}^{m'} w_k \left\langle \Phi_i(\mathbf{p}) \Phi_j(\mathbf{p}) \Phi_k(\mathbf{p}) \frac{\partial \mathbf{f}}{\partial \mathbf{x}} \left(\sum_{l=0}^m \mathbf{v}_l(\tau) \Phi_l(\mathbf{p}), \mathbf{p} \right) \right\rangle. \end{aligned} \quad (30)$$

The interchange of the differentiation and the integration is based on the assumption that the functions in the Jacobian matrix $\frac{\partial \mathbf{f}}{\partial \mathbf{x}} \in \mathbb{R}^{n \times n}$ are continuous in all variables.

Solving the initial value problem (29) with the matrix (30) yields the monodromy matrix $N(1)$, which exhibits $(m+1)n$ eigenvalues. Since the system (20) is autonomous, an eigenvalue $\lambda_1 = 1$ occurs. We assume that the original system (2) features stable periodic solutions for all parameters $\mathbf{p} \in Q$. An interesting information is if the periodic solution of the gPC system (20) is also stable in this case. For a small variance of the parameters, $m+1$ clusters of n eigenvalues are present. Consequently, one cluster is situated around $\lambda_1 = 1$. The question is if all but one eigenvalues of this cluster have a modulus smaller than one.

5 Numerical Simulation

Figure 2 demonstrates the electric circuit of a Colpitt oscillator, which represents a typical LC-oscillator. The circuit includes four capacitances, four resistances, an inductance and a bipolar transistor. A specific mathematical modelling, see [4],

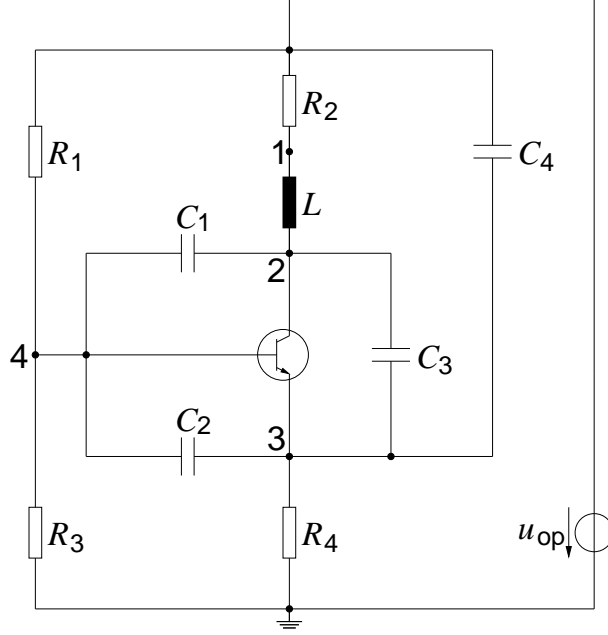

Figure 2: Circuit of Colpitt oscillator.

yields a system of implicit ODEs of the type (2) for four unknown node voltages

$$\begin{pmatrix} 1 & 0 & 0 & 0 \\ 0 & C_1 + C_3 & -C_3 & -C_1 \\ 0 & -C_3 & C_2 + C_3 + C_4 & -C_2 \\ 0 & -C_1 & -C_2 & C_1 + C_2 \end{pmatrix} \begin{pmatrix} \dot{u}_1 \\ \dot{u}_2 \\ \dot{u}_3 \\ \dot{u}_4 \end{pmatrix} = \begin{pmatrix} \frac{R_2}{L}(u_2 - u_1) \\ \frac{1}{R_2}(u_{op} - u_1) + (\iota_S + \frac{\iota_S}{b_C})g(u_4 - u_2) - \iota_S g(u_4 - u_3) \\ -\frac{1}{R_4}u_3 + (\iota_S + \frac{\iota_S}{b_E})g(u_4 - u_3) - \iota_S g(u_4 - u_2) \\ -\frac{1}{R_3}u_4 + \frac{1}{R_1}(u_{op} - u_4) - \frac{\iota_S}{b_E}g(u_4 - u_3) - \frac{\iota_S}{b_C}g(u_4 - u_2) \end{pmatrix}. \quad (31)$$

The current-voltage relation of the bipolar transistor is described by the nonlinear function $g(u) = \exp(u/U_{th}) - 1$. We apply the technical parameters

$$\begin{aligned}
 C_1 &= 5 \cdot 10^{-11} \text{ F}, & C_2 &= 10^{-9} \text{ F}, & C_3 &= 5 \cdot 10^{-8} \text{ F}, & C_4 &= 10^{-7} \text{ F}, \\
 R_1 &= 12000 \text{ } \Omega, & R_2 &= 3 \text{ } \Omega, & R_3 &= 8200 \text{ } \Omega, & R_4 &= 1500 \text{ } \Omega, \\
 L &= 0.01 \text{ H}, & u_{op} &= 10 \text{ V}, & \iota_S &= 10^{-3} \text{ A}, & b_E &= 100, & b_C &= 50, \\
 U_{th} &= 2.585 \cdot 10^{-2} \text{ V}.
 \end{aligned}$$

A periodic solution with time rate $T_0 = 1.25 \cdot 10^{-4}$ s exists, which is shown in Figure 3. This solution has been computed using the phase condition (8) with $\eta = 10$. A shooting method, see [13], determined a numerical solution, where the trapezoidal rule was applied in solving initial value problems.

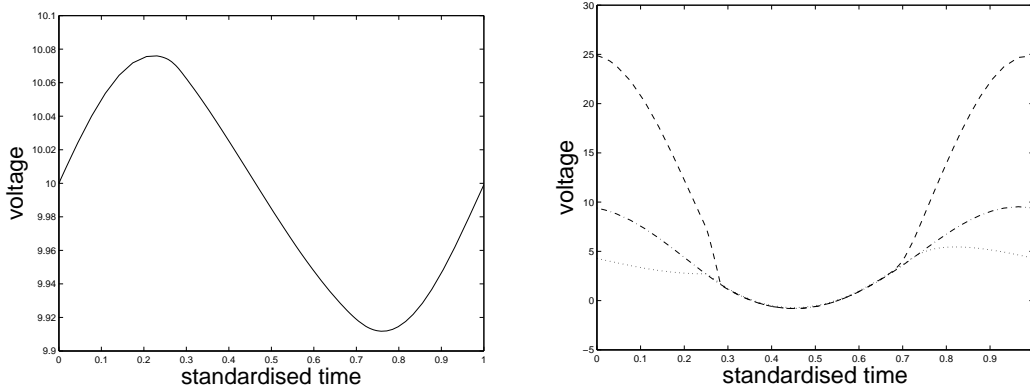

Figure 3: Periodic solution of Colpitt oscillator obtained via a phase condition (u_1 : —, u_2 : - - -, u_3 : - · - · -, u_4 : ···).

We arrange the random parameter

$$\hat{C}_3(\xi) := C_3(1 + d\xi) \quad (32)$$

with a constant $d > 0$ and a uniformly distributed random variable $\xi \in [-1, 1]$. The capacitance matrix in the left-hand side of (31) is regular for all $\hat{C}_3(\xi)$ provided that $d < 1$ holds. We choose a relatively large uncertainty of 10%, i.e., we fix $d := 0.1$ in the following.

We apply the gPC system (17) according to the autonomous implicit system (31). We select $m = m' = 3$ in the finite gPC expansions (15). Hence the system (17) consists of 16 equations. In case of the uniform distribution, the orthogonal basis functions are the Legendre polynomials.

The periodic boundary value problem (17),(19) has to be solved. As additional conditions to determine the values w_j , we use (23) with

$$v_{0,1} = 10, \quad v_{i,1} = 0 \quad \text{for } i = 1, 2, 3. \quad (33)$$

A shooting method identified a numerical solution of the boundary value problem, where the trapezoidal rule solved the involved initial value problems again. To evaluate the right-hand side of (17), approximations of the expected values (11) were calculated by Gauss-Legendre quadrature using 10 nodes.

Figure 4 depicts the approximations of the expected values and the variances obtained by the numerical solution using the gPC. The expected values are similar to the deterministic solution shown in Figure 3. We notice that the component u_1 is not sensitive with respect to the random capacitance, since its variance is nearly zero. The expected values coincide with the coefficient functions of degree $i = 0$.

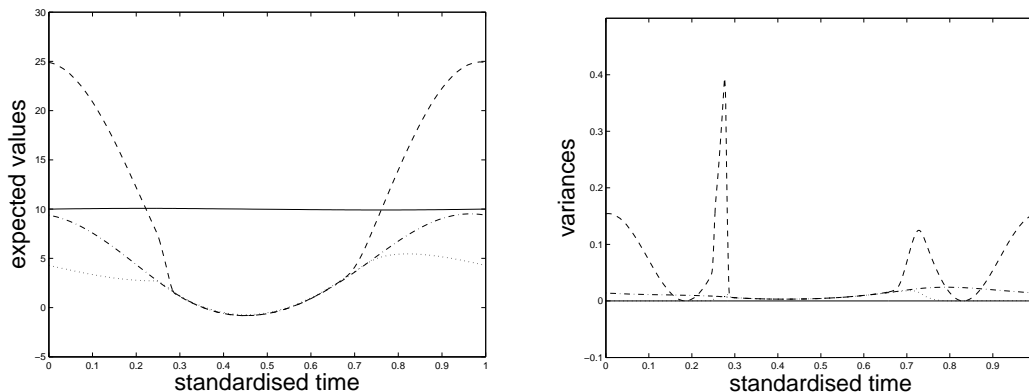

Figure 4: Expected values (left) and variances (right) of all components obtained by gPC simulation of Colpitt oscillator (u_1 : —, u_2 : - - -, u_3 : - · - ·, u_4 : · · ·).

Figure 5 and Figure 6 depict the other coefficient functions of the components u_1 and u_4 , respectively. In case of u_1 , we recognise the conditions (33). The approximation of the coefficients corresponding to the random period, see (15), reads

$$w_0 = 1.2508 \cdot 10^{-4}, \quad w_1 = 1.4019 \cdot 10^{-6}, \quad w_2 = -3.0163 \cdot 10^{-8}, \quad w_3 = 1.3170 \cdot 10^{-9}.$$

This data can be used in a reconstruction (25) if desired.

For comparison, we compute approximations of the expected values and the variances by a quasi Monte-Carlo method. Since a single random parameter (32) is considered, we simply use equidistant realisations

$$\xi^j := -1 + (j - 1)\Delta\xi \quad \text{for } j = 1, \dots, K \quad \text{with } \Delta\xi := \frac{2}{K - 1}. \quad (34)$$

Hence K periodic boundary value problems of the system of ODEs (31) have been solved by a shooting method for the different parameters. Figure 7 illustrates the corresponding mean values and sample variances using $K = 1000$. The results agree to the simulation of the gPC system (17) shown in Figure 4.

Furthermore, we investigate the local stability of the periodic solutions of the gPC system (17) with four different magnitudes $d = 0.01, 0.1, 0.2, 0.3$ of uncertainty in (32). The periodic states of the underlying system (31) are locally stable for all involved random capacitances \hat{C}_3 . The periodic solutions of (17) are computed numerically as outlined above. We solve the initial value problems (29) by trapezoidal rule to obtain the corresponding monodromy matrices. The modulus of the resulting eigenvalues is depicted in Figure 8. In all cases, eight eigenvalues are close to zero, which reflects that the underlying ODE system (31) is stiff.

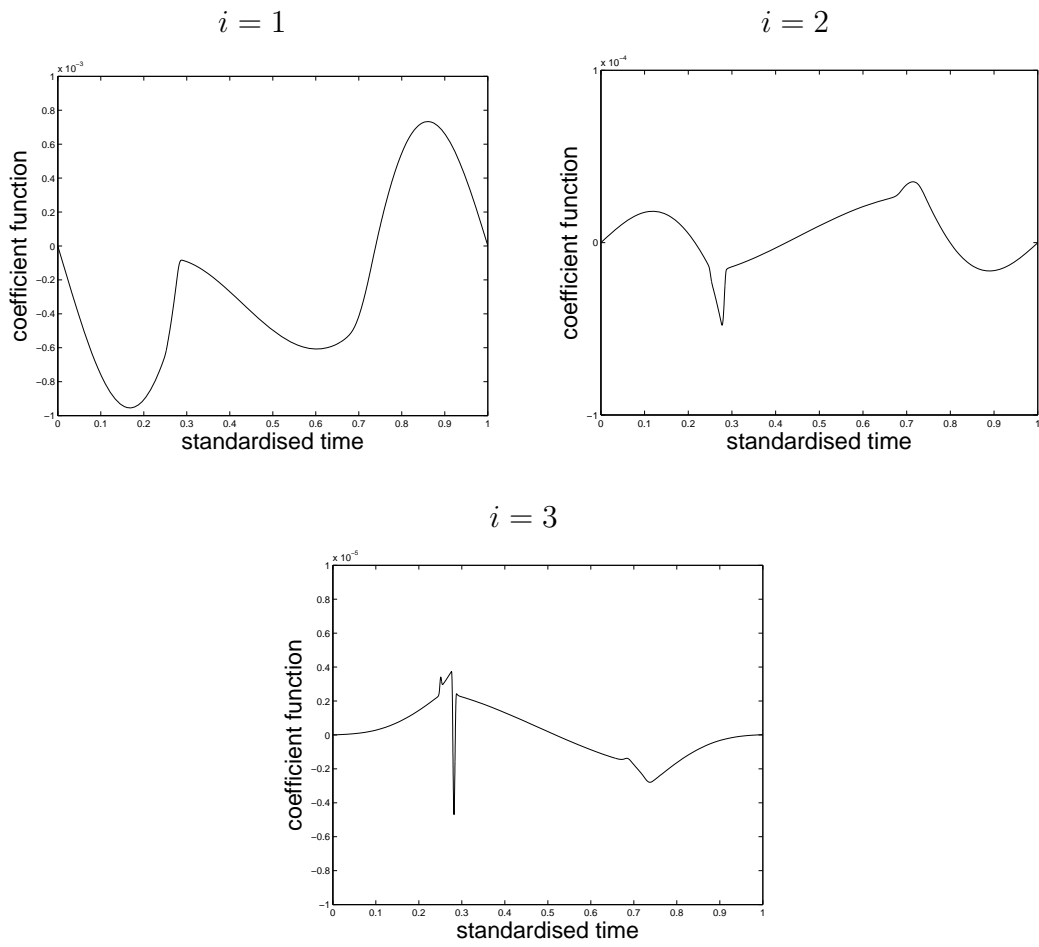

Figure 5: Coefficient functions v_i of gPC expansion for u_1 .

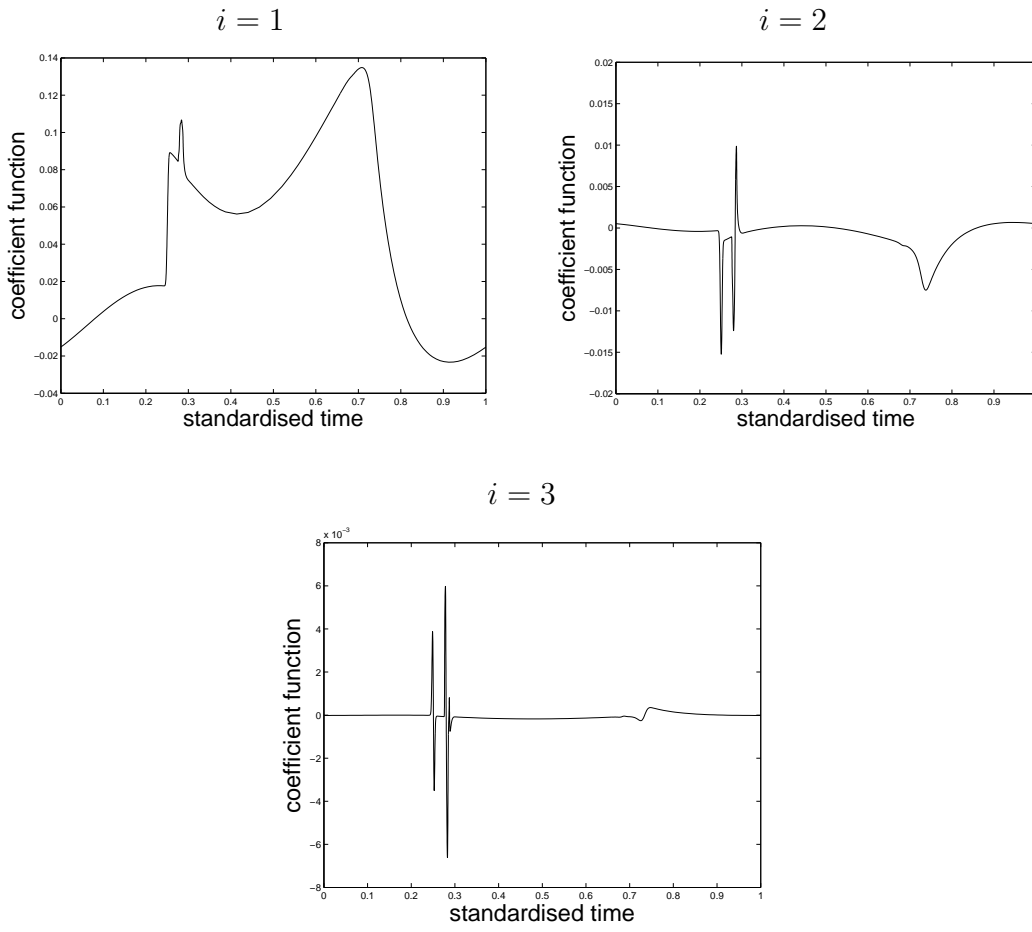

Figure 6: Coefficient functions v_i of gPC expansion for u_4 .

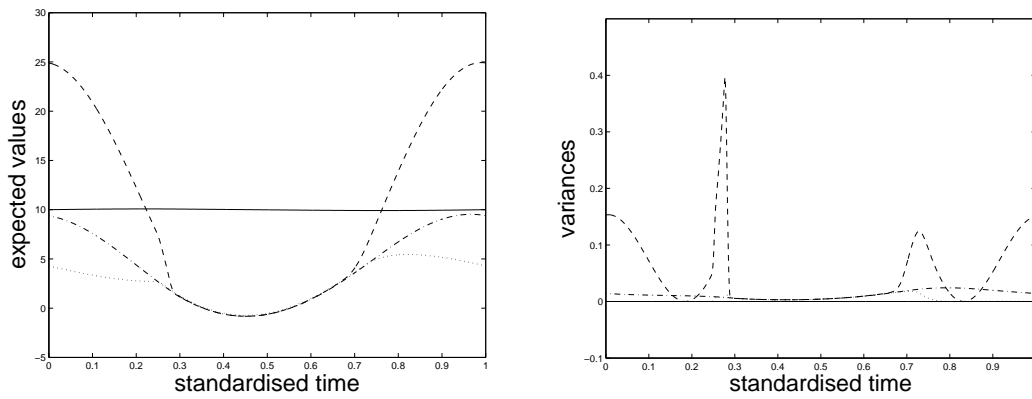

Figure 7: Expected values (left) and variances (right) of all components determined by quasi Monte-Carlo method applied to ODE system of Colpitt oscillator (u_1 : —, u_2 : - - -, u_3 : - · - · -, u_4 : · · ·).

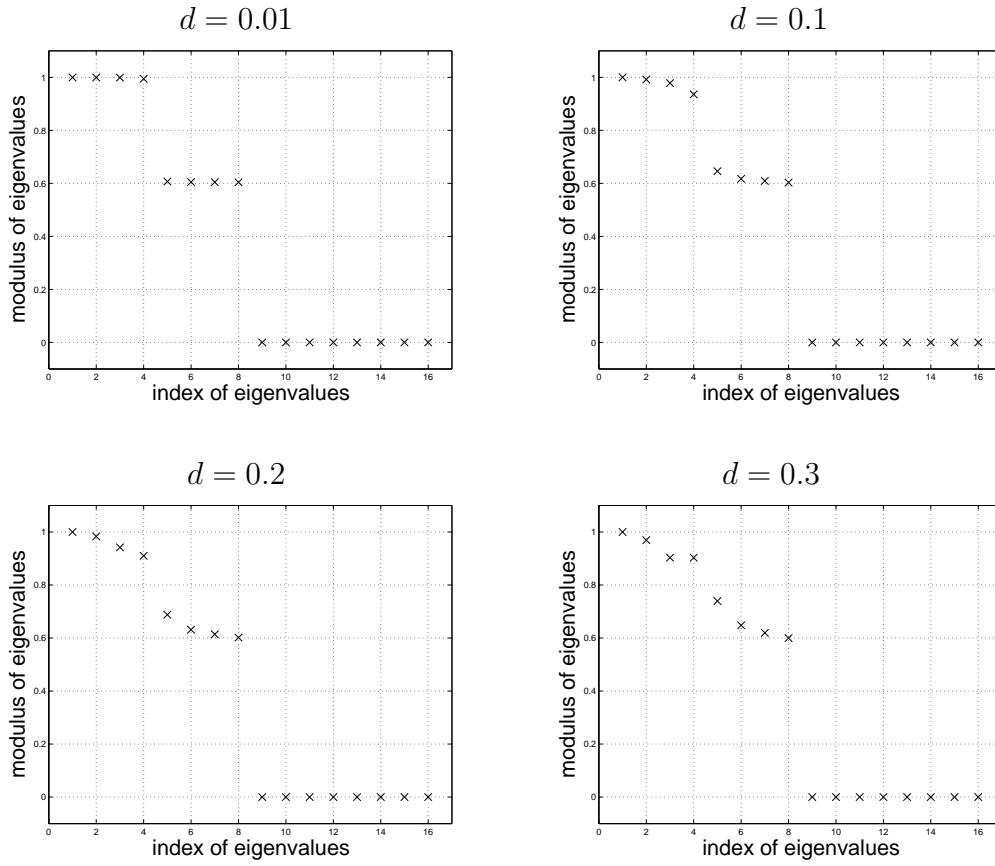

Figure 8: Eigenvalues of monodromy matrix for gPC system corresponding to Colpitt oscillator. Different magnitudes d of the uncertainty are applied in (32).

For a small value d , we recognise the clusters of eigenvalues. In the case of tiny parameters d , we cannot decide if an eigenvalue from the cluster around $\lambda_1 = 1$ exhibits a modulus smaller or larger one due to small errors in the applied numerical methods. In the given examples, all but one eigenvalues have a modulus smaller than one. Hence the periodic solutions of the gPC system (17) are locally stable.

6 Conclusions

The gPC yields strategies to resolve systems of ODEs or DAEs with random parameters. In case of oscillators, periodic boundary value problems are considered. We have applied a Galerkin method to obtain a coupled system of ODEs or DAEs, respectively, for the unknown coefficient functions in the gPC expansion. Additional conditions to identify the coefficients of the random period have been constructed in the case of autonomous oscillators. We investigated the concept of local stability for periodic solutions satisfying the autonomous coupled system from gPC. Numerical simulations demonstrate that the used gPC approach resolves the stochastic model correctly. Moreover, the periodic solution of the coupled system is locally stable in the employed test example. An open question is if the solution of the coupled system inherits the stability of the periodic solutions satisfying the original systems in general.

References

- [1] Augustin, F., Gilg, A., Paffrath, M., Rentrop, P., and Wever, U.: *Polynomial chaos for the approximation of uncertainties: chances and limits*. Euro. Jnl. of Applied Mathematics, 19 (2008), 149–190.
- [2] Ghanem, R.G., and Spanos, P.D.: *Stochastic Finite Elements*. Rev. Ed., Dover Publications Inc., Mineola, New York, 2003.
- [3] Günther, M., Feldmann, U., and ter Maten, E.J.W.: *Modelling and discretization of circuit problems*. In: Schilders, W.H.A., ter Maten, E.J.W. (eds.), *Handbook of Numerical Analysis, Vol. XIII: Numerical Methods in Electromagnetics*, Elsevier, North Holland, 2005, 523–659.
- [4] Kampowsky, W., Rentrop, P., and Schmitt, W.: *Classification and numerical simulation of electric circuits*. Surv. Math. Ind., 2 (1992), 23–65.
- [5] Lamour, R., März, R., and Winkler, R.: *How Floquet theory applies to index-1 differential algebraic equations*. J. Math. Anal. Appl., 217 (1998), 372–394.
- [6] Lamour, R., März, R., and Winkler, R.: *Stability of periodic solutions of index-2 differential algebraic systems*. J. Math. Anal. Appl., 279 (2003), 475–494.
- [7] Lucor, D., and Karniadakis, G.E.: *Adaptive generalized polynomial chaos for nonlinear random oscillators*. SIAM J. Sci. Comput., 26 (2004), 720–735.

- [8] Lucor, D., Su, C.H., and Karniadakis, G.E.: *Generalized polynomial chaos and random oscillators*. Int. J. Numer. Meth. Engng., 60 (2004), 571–596.
- [9] Pulch, R.: *Polynomial chaos for linear DAEs with random parameters*. Preprint, Bergische Universität Wuppertal (2008).
- [10] Pulch, R.: *Polynomial chaos for analysing periodic processes of differential algebraic equations with random parameters*. submitted to: Proc. Appl. Math. Mech.
- [11] Pulch, R.: *Polynomial chaos for the computation of failure probabilities in periodic problems*. to appear in: Proceedings of SCEE, Espoo, Finland, 2008.
- [12] Seydel, R.: *Practical Bifurcation and Stability Analysis*. 2nd ed., Springer, New York, 1994.
- [13] Stoer, J., and Bulirsch, R.: *Introduction to Numerical Analysis*. 3rd ed., Springer, New York, 2002.
- [14] Xiu, D., and Karniadakis, G.E.: *The Wiener-Askey polynomial chaos for stochastic differential equations*. SIAM J. Sci. Comput., 24 (2002), 619–644.
- [15] Xiu, D., and Hesthaven, J.S.: *High order collocation methods for differential equations with random inputs*. SIAM J. Sci. Comput., 27 (2005), 1118–1139.
- [16] Xiu, D.: *Efficient collocation approach for parametric uncertainty analysis*. Comm. Comput. Phys., 2 (2007), 293–309.
- [17] Xiu, D.: *Fast numerical methods for stochastic computations: a review*. Comm. Comput. Phys., 5 (2009), 242–272.