

Congratulations, you and your MacBook Pro
were made for each other.

Built-in iSight camera

Video chat with up to three friends anywhere in the world at the same time.

www.apple.com/macbookpro

Mac Help  iSight



Finder

Browse the contents of your computer using Cover Flow.

www.apple.com/macosx

Mac Help  finder



Time Machine

Automatically back up your files to an external hard drive.

www.apple.com/macosx

Mac Help  time machine



iMovie

Collect all your video in one library. Create and share movies in minutes.

www.apple.com/ilife/imovie

[iMovie Help](#)  [movie](#)



iPhoto

Organize all your photos with Events. Publish to a Web Gallery with a click.

www.apple.com/ilife/iphoto

[iPhoto Help](#)  [photo](#)



GarageBand

Create music by adding musicians to a virtual stage. Enhance your song to sound like a pro.

www.apple.com/ilife/garageband

[GarageBand Help](#)  [record](#)



iWeb

Create beautiful websites with photos, movies, blogs, podcasts, and dynamic web widgets.

www.apple.com/ilife/iweb

[iWeb Help](#)  [website](#)

Contents

Chapter 1: Ready, Set Up, Go

- 9 What's in the Box
- 9 Setting Up Your MacBook Pro
- 15 Putting Your MacBook Pro to Sleep or Shutting It Down

Chapter 2: Life with Your MacBook Pro

- 18 Basic Features of Your MacBook Pro
- 20 Additional Features of Your MacBook Pro
- 22 Keyboard Features of Your MacBook Pro
- 24 Ports on Your MacBook Pro
- 26 Using the Trackpad and Keyboard
- 28 Using the MacBook Pro Battery
- 30 Getting Answers

Chapter 3: Boost Your Memory

- 35 Installing Additional Memory
- 43 Making Sure Your MacBook Pro Recognizes the New Memory

Chapter 4: Problem, Meet Solution

- 46 Problems That Prevent You from Using Your MacBook Pro

- 51 Using Apple Hardware Test
- 51 Problems with Your Internet Connection
- 54 Problems with AirPort Extreme Wireless Communication
- 55 Keeping Your Software Up to Date
- 56 Reinstalling the Software That Came with Your MacBook Pro
- 57 Learning More, Service, and Support
- 59 Locating Your Product Serial Number

Chapter 5: Last, but Not Least

- 62 Important Safety Information
- 65 Important Handling Information
- 67 Understanding Ergonomics
- 69 Apple and the Environment
- 70 Regulatory Compliance Information

Looking for Something?

- 76 Index

1

Ready, Set Up, Go

www.apple.com/macbookpro

Mac Help  Migration Assistant

Your MacBook Pro is designed so that you can set it up quickly and start using it right away. If you have never used a MacBook Pro or are new to Macintosh computers, read this chapter for help getting started.

Important: Read all the installation instructions (and the safety information starting on page 61) carefully before you first use your computer.

If you are an experienced user, you may already know enough to get started. Make sure you look over the information in Chapter 2, “Life with Your MacBook Pro,” to find out about the new features of this MacBook Pro.

Many answers to questions can be found on your computer in Mac Help. For information about getting Mac Help, see “Getting Answers” on page 30. Apple may release new versions and updates to its system software, so the images shown in this book may be slightly different from what you see onscreen. Some computer illustrations might also be slightly different, depending on the model of your MacBook Pro.

Important: Remove the protective film around the 85W MagSafe Power Adapter before setting up your MacBook Pro.

What's in the Box

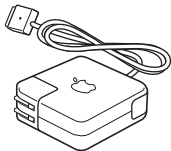
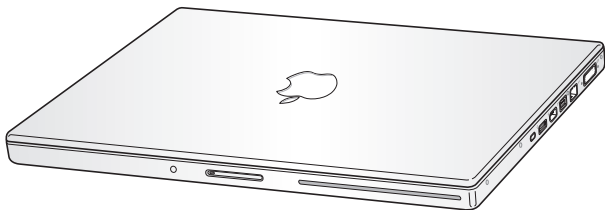

85W MagSafe Power Adapter



DVI to VGA adapter



AC power cord

Setting Up Your MacBook Pro

Your MacBook Pro is designed so that you can set it up quickly and start using it right away. The following pages take you through the setup process, including these tasks:

- Plugging in the 85W MagSafe Power Adapter
- Connecting cables and accessing a network
- Turning on your MacBook Pro and using the trackpad
- Configuring a user account and other settings using Setup Assistant
- Setting up the Mac OS X desktop and preferences

Step 1: Plug In the 85W MagSafe Power Adapter to provide power to the MacBook Pro and charge the battery.

Make sure the AC plug is fully inserted into the power adapter and the electrical prongs on your AC plug are in their completely extended position. Insert the AC plug of your power adapter into a power outlet and the MagSafe connector into the MagSafe power port. As the MagSafe connector gets close to the port, you'll feel a magnetic pull drawing it in.

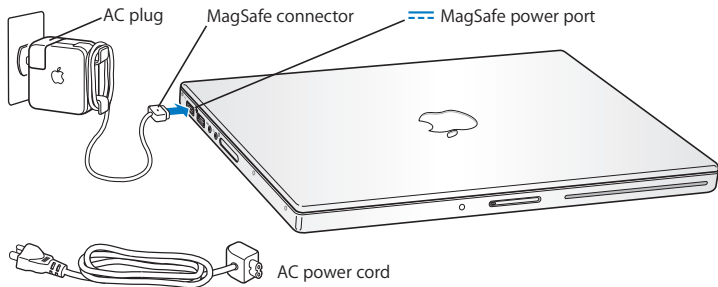

To extend the reach of your power adapter, replace the AC plug with the AC power cord. First pull the AC plug up to remove it from the adapter, and then attach the included AC power cord to the adapter, making sure it is seated firmly. Plug the other end into a power outlet. The AC power cord provides a grounded connection.

When disconnecting the power adapter from an outlet or from the computer, pull the plug, not the cord.

Note: When you first connect the power adapter to your MacBook Pro, an indicator light on the MagSafe connector starts to glow. An amber light indicates the battery is charging. A green light indicates that the battery is fully charged or is not installed. If you don't see a light, make sure the connector is seated properly and the power adapter is plugged into a power outlet.

Step 2: To access the Internet or a network, connect one end of an Ethernet cable to your MacBook Pro and the other end to a cable modem, DSL modem, or network.

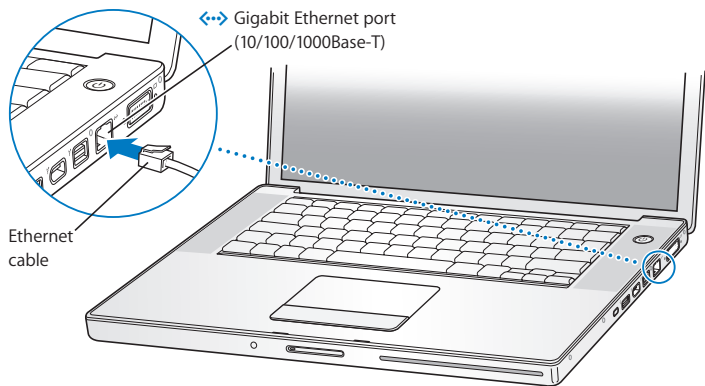

To use a dial-up connection, you need the external Apple USB Modem, available for purchase from the online Apple Store at www.apple.com/store or from an Apple Authorized Reseller. Plug the Apple USB Modem into a USB port on your MacBook Pro, and then connect a phone cord (not included) from the modem into a phone wall jack.

Note: Your MacBook Pro also comes with AirPort Extreme technology for wireless networking. For information about setting up a wireless connection, from the menu bar, choose Help > Mac Help, and then search for “AirPort.” See “Getting Answers” on page 30.

Step 3: Press the power (⏻) button briefly to turn on your MacBook Pro.

You hear a tone when you turn on the computer.

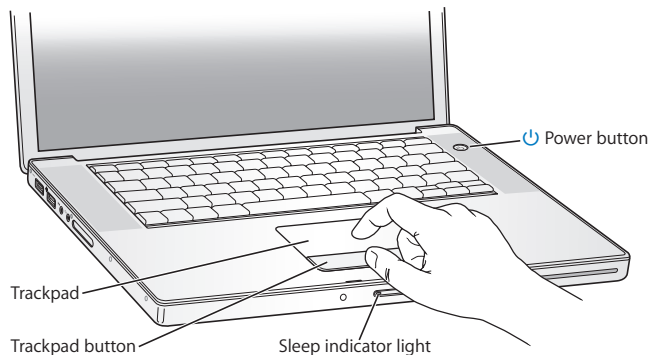

It takes the MacBook Pro a few moments to start up. After it starts up, Setup Assistant opens automatically.

If your MacBook Pro doesn't turn on, see "If your MacBook Pro doesn't turn on or start up" on page 49.

Step 4: Configure your MacBook Pro with Setup Assistant.

The first time you turn on your MacBook Pro, Setup Assistant starts. Setup Assistant helps you enter your Internet and email information and set up a user account on your MacBook Pro. If you already have a Mac, Setup Assistant can help you automatically transfer files, applications, and other information from your previous Mac.

If you don't intend to keep or use your other Mac, it's best to deauthorize it from playing music, videos, or audiobooks that you've purchased from the iTunes Store. Deauthorizing a computer prevents any songs, videos, or audiobooks you've purchased from being played by someone else and frees up another authorization for use. For information about deauthorizing, choose iTunes Help from the Help menu in iTunes.

If you don't use Setup Assistant to transfer information when you first start up, you can do it later using Migration Assistant. Go to the Applications folder, open Utilities, and double-click Migration Assistant.

Step 5: Customize the Mac OS X desktop and set preferences.

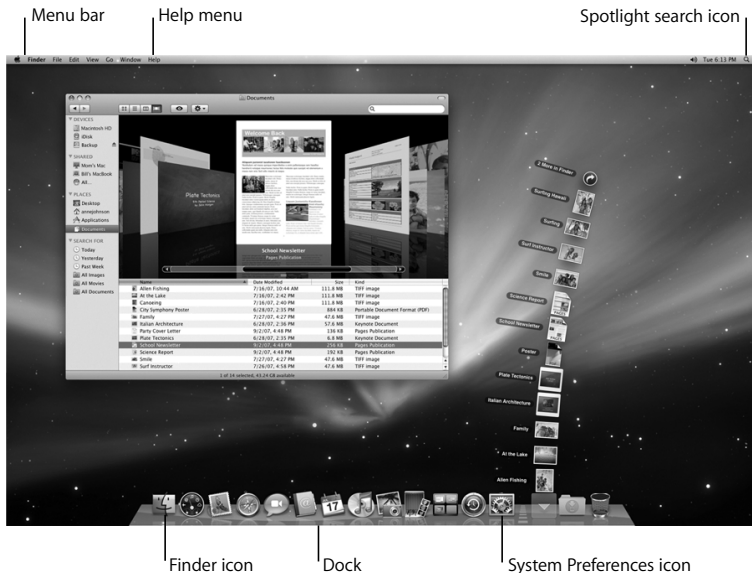

You can quickly make the desktop look the way you want using System Preferences. Choose Apple () > System Preferences from the menu bar or click the System Preferences icon in the Dock. System Preferences is your command center for most settings on your MacBook Pro. For more information, open Mac Help and search for “System Preferences” or for the specific preference you want to change.

Putting Your MacBook Pro to Sleep or Shutting It Down

When you finish working with your MacBook Pro, you can put it to sleep or shut it down.

Putting Your MacBook Pro to Sleep

If you'll be away from your MacBook Pro for only a short time, put it to sleep. When the computer is in sleep, you can quickly wake it and bypass the startup process.

To put your MacBook Pro to sleep, do one of the following:

- Close the display.
- Choose Apple () > Sleep from the menu bar.
- Press the power (⏻) button and click Sleep in the dialog that appears.
- Choose Apple () > System Preferences, click Energy Saver, and set a sleep timer.

NOTICE: Wait a few seconds until the sleep indicator light starts pulsing (indicating that the computer is in sleep and the hard disk has stopped spinning) before moving your MacBook Pro. Moving your computer while the disk is spinning can damage the hard disk, causing loss of data or the inability to start up from the hard disk.

To wake your MacBook Pro:

- *If the display is closed*, simply open it to wake up your MacBook Pro.
- *If the display is already open*, press the power (⏻) button or any key on the keyboard.

When your MacBook Pro wakes from sleep, your applications, documents, and computer settings are exactly as you left them.

Shutting Down Your MacBook Pro

If you aren't going to use your MacBook Pro for a day or two, it's best to shut it down. The sleep indicator light goes on briefly during the shutdown process.

To shut down your MacBook Pro, do one of the following:

- Choose Apple () > Shut Down from the menu bar.
- Press the power (⏻) button and click Shut Down in the dialog that appears.

If you plan to store your MacBook Pro for an extended period of time, see “Important Handling Information” on page 65 for information about how to prevent the battery from draining completely.

2

Life with Your MacBook Pro

www.apple.com/macosex

Mac Help  Mac OS X

Basic Features of Your MacBook Pro

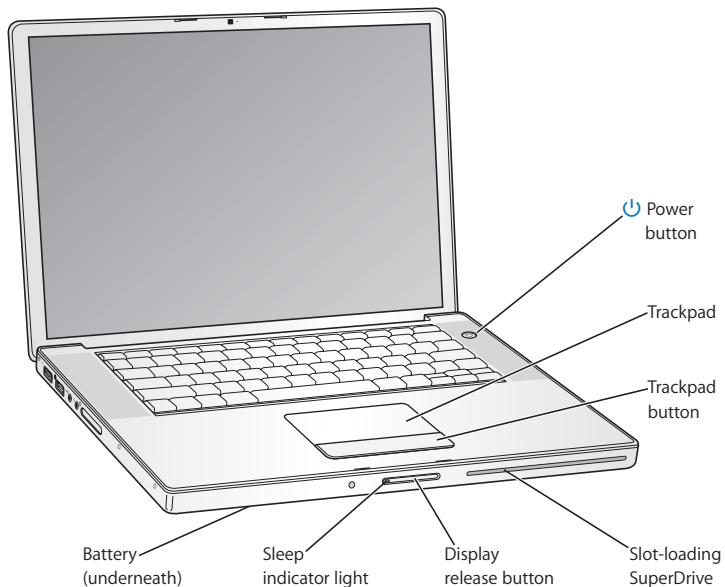

**Power button**

Turn your MacBook Pro on and off, or put it to sleep.

Trackpad and trackpad button

Move the pointer with one finger on the trackpad, scroll with two fingers, or page through documents with three fingers. Tap the trackpad to click or double-click. Spread or pinch two fingers to zoom in or out. Use two fingers to rotate photos and more.

Slot-loading SuperDrive

This optical drive reads and writes to standard-size CDs and DVDs.

Display release button

Push to release the display and open your MacBook Pro.

Sleep indicator light

A white light pulses when the MacBook Pro is in sleep.

Battery

Run your MacBook Pro using battery power when you are away from a power outlet.

Additional Features of Your MacBook Pro

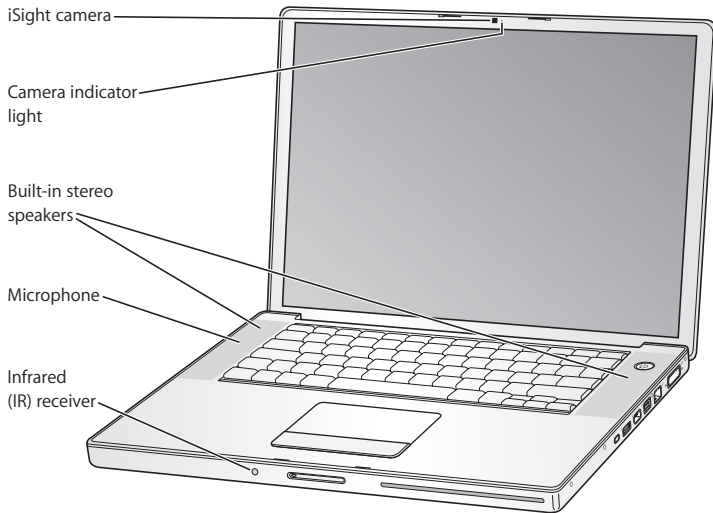

Built-in iSight camera

Videoconference with others using the included iChat AV application, take pictures with Photo Booth, or capture video with iMovie '08.

Camera indicator light

The camera indicator light glows green when the built-in iSight camera is operating.

Built-in stereo speakers

Listen to music, movies, games, and other multimedia files.

Microphone (built in under the left speaker grille)







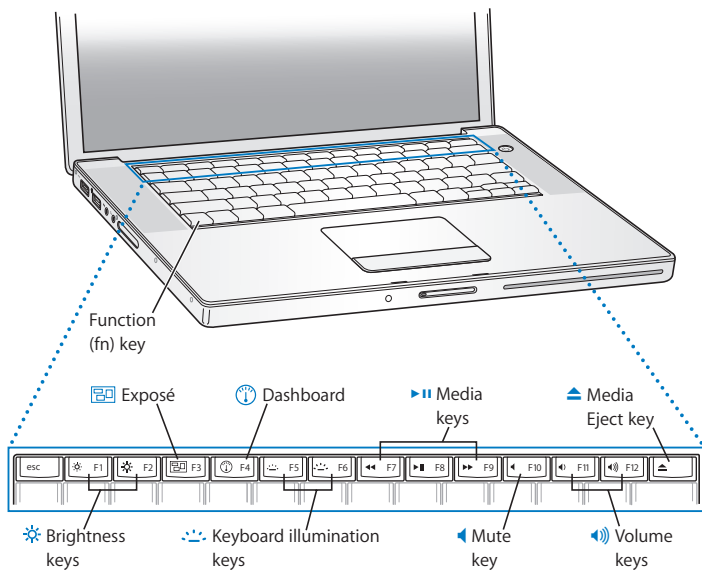

Capture sounds directly or talk with friends live using the included iChat AV application.

Infrared (IR) receiver

Use an optional Apple Remote (sold separately at www.apple.com/store) with the IR receiver to control Front Row and Keynote on your MacBook Pro from up to 30 feet away.

Keyboard Features of Your MacBook Pro



	Function (fn) key Press and hold this key to activate customized actions assigned to the function keys (F1 to F12). To learn how to customize function keys, choose Help > Mac Help from the menu bar and search for “function keys.”
	Brightness keys (F1, F2) Increase (☀) or decrease (☾) the brightness of your MacBook Pro display.
	Exposé All Windows key (F3) Open Exposé for quick access to all your open windows.
	Dashboard key (F4) Open Dashboard to access your widgets.
	Keyboard illumination keys (F5, F6) Increase (☀) or decrease (☾) the brightness of the keyboard illumination.
	Media keys (F7, F8, F9) Rewind (⏮), play or pause (⏮), or fast-forward (⏭) a song, movie, or slideshow.
	Mute key (F10) Mute the sound coming from the built-in speakers and headphone port.
	Volume keys (F11, F12) Increase (🔊) or decrease (🔇) the volume of sound coming from the built-in speakers and headphone port.
	Media Eject key Press and hold this key to eject a disc. You can also eject a disc by dragging its desktop icon to the Trash.

Ports on Your MacBook Pro

Left side

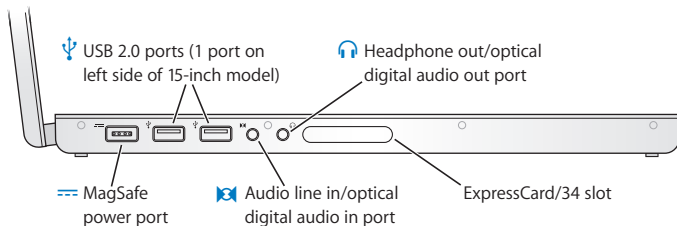

Right side

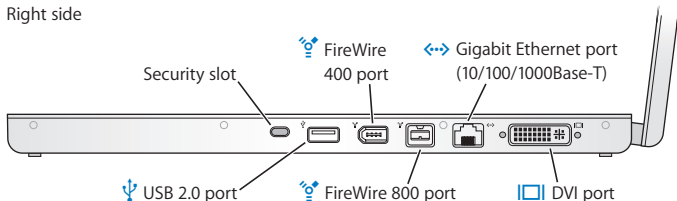

**MagSafe power port**

Plug in the included 85W MagSafe Power Adapter to recharge the MacBook Pro battery.

**High-speed USB (Universal Serial Bus) 2.0 ports**

Connect a modem, iPod, mouse, keyboard, printer, disk drive, digital camera, joystick, and more to your MacBook Pro. You can also connect USB 1.1 devices.

**Audio line in/optical digital audio in port**

Connect your MacBook Pro to a line-level microphone or digital audio equipment.

**Headphone out/optical digital audio out port**

Connect external speakers, headphones, or digital audio equipment.

ExpressCard/34 slot

Expand the capabilities of your MacBook Pro with standard 34mm ExpressCards. To eject an ExpressCard, push gently on it to activate the spring, and then remove it from the slot.

Security slot

Attach a lock and cable (available at www.apple.com/store) to prevent theft.

**Two FireWire ports (FireWire 400 and FireWire 800)**

Connect high-speed external devices, such as digital video cameras and storage devices.

**Gigabit Ethernet port (10/100/1000Base-T)**

Connect to a high-speed Ethernet network, a DSL or cable modem, or another computer. The Ethernet port automatically detects Ethernet devices and doesn't require an Ethernet crossover cable.

**DVI (external display) port**

Connect to an external display, projection device, or TV that uses a DVI connector, or use the included DVI to VGA adapter to connect a VGA monitor.

Using the Trackpad and Keyboard

Use the trackpad to move the cursor and to scroll, tap, double-tap, and drag. How far the pointer moves onscreen is affected by how quickly you move your finger across the trackpad. To move the pointer a short distance, move your finger slowly across the trackpad; the faster you move your finger, the farther the pointer moves. To fine-tune the tracking speed and set other trackpad options, choose Apple (🍏) > System Preferences, click Keyboard & Mouse, and then click Trackpad.

Here are some useful keyboard and trackpad tips and shortcuts:

- *Forward deleting* deletes characters to the right of the insertion point. Pressing the Delete key deletes characters to the left of the insertion point.

To forward delete, hold down the Function (fn) key while you press the Delete key.

- *Secondary clicking* or “right-clicking” lets you access shortcut menu commands.

To secondary click, place two fingers on the trackpad while clicking the trackpad button. If Tap to Click is enabled, just tap two fingers on the trackpad.

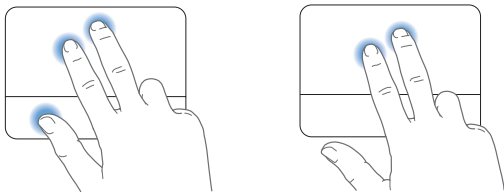

You can also secondary click by holding down the Control key while you click.

- *Two-finger scrolling* lets you drag to scroll quickly up, down, or sideways in the active window. This option is on by default.

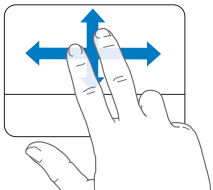

The following trackpad gestures work in certain applications, such as Preview or iPhoto. For more information, choose Help > Mac Help and search for “trackpad.”

- *Two-finger pinching* lets you zoom in or out on PDFs, images, photos, and more.

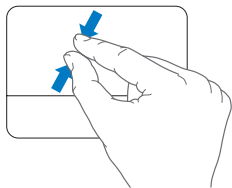
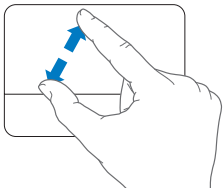

- *Two-finger rotating* lets you rotate photos, pages, and more.
- *Three-finger swiping* lets you rapidly page through documents, move to the previous or next photo, and more.

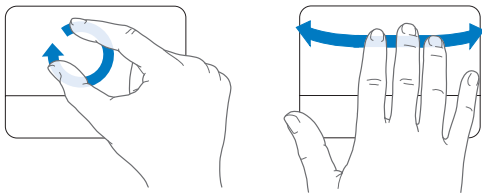

Using the MacBook Pro Battery

When the MagSafe power adapter isn't connected, your MacBook Pro draws power from its battery. The length of time that you can run your MacBook Pro varies, depending on the applications you use and the external devices connected to your MacBook Pro. Turning off features such as AirPort Extreme or Bluetooth® wireless technology can help conserve the battery charge.

If the battery runs low while you're working, attach your power adapter and let the battery recharge. To replace a low battery with a charged one when you aren't using a power adapter, shut down your MacBook Pro and follow the steps on page 35.

You can determine the charge left in the battery by looking at the battery level indicator lights on the battery. Press the button next to the lights and the lights will glow briefly to show how much charge is left in the battery. You can check the charge with the battery in or out of your MacBook Pro.

Important: If only one indicator light is on, very little charge is left. If no lights are on, the battery is completely drained and the MacBook Pro won't start up unless the power adapter is connected. Plug in the power adapter to let the battery recharge, or replace the drained battery with a fully charged battery (see page 42).

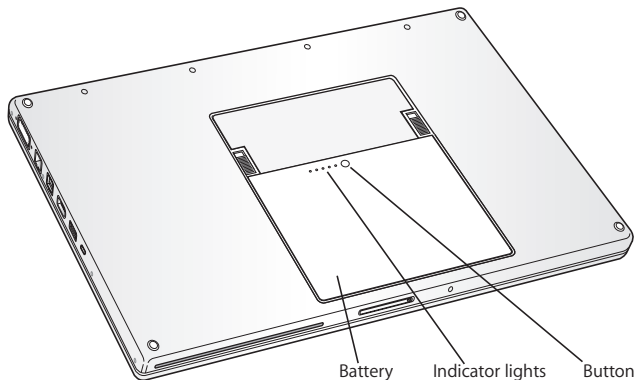

The amount of battery charge left can also be checked by viewing the Battery (🔋) status icon in the menu bar. The battery charge level displayed is based on the amount of power left in the battery with the applications, peripheral devices, and system settings you are currently using. To conserve battery power, close applications and disconnect peripheral devices not in use, and adjust your Energy Saver settings. For more information about battery conservation and performance tips, go to www.apple.com/batteries/notebooks.html.

Charging the Battery

When the power adapter that came with your MacBook Pro is connected, the battery charges whether the computer is on, off, or in sleep. The battery charges more quickly, however, if the computer is off or in sleep.

Getting Answers

Much more information about using your MacBook Pro is available in Mac Help on your computer and on the Internet at www.apple.com/support/macbookpro.

To get Mac Help:

- 1 Click the Finder icon in the Dock (the bar of icons along the edge of the screen).



- 2 Click the Help menu in the menu bar and do one of the following:
 - a Type a question or term in the Search field, and select a topic from the list of results or select Show All Results to see all topics.
 - b Choose Mac Help to open the Mac Help window, where you can click links or type a search question.

More Information

For more information about using your MacBook Pro, see the following:

To learn about	Do this
Installing memory	See Chapter 3, “Boost Your Memory,” on page 33.
Troubleshooting your MacBook Pro if you have a problem	See Chapter 4, “Problem, Meet Solution,” on page 45.
Finding service and support for your MacBook Pro	See “Learning More, Service, and Support” on page 57. Or go to the Apple Support website at www.apple.com/support/macbookpro .
Using Mac OS X	Go to the Mac OS X website at www.apple.com/macosx . Or search for “Mac OS X” in Mac Help.
Moving from a PC to a Mac	See “How to move to Mac” at www.apple.com/getamac/movetomac .
Using iLife '08 applications	Go to the iLife website at www.apple.com/ilife . Or open an iLife '08 application, open Help for the application, and then type a question in the search field.
Changing System Preferences	Open System Preferences by choosing Apple () > System Preferences. Or search for “system preferences” in Mac Help.
Using your trackpad	Experiment with gestures within any application to see what functionality it supports. Search for “trackpad” in Mac Help. Or open System Preferences and click Keyboard & Mouse and then click Trackpad.
Using the iSight camera	Search for “iSight” in Mac Help.
Using AirPort Extreme wireless technology	Go to the AirPort Support page at www.apple.com/support/airport . Or open Mac Help and search for “AirPort.”

To learn about	Do this
Using Bluetooth wireless technology	Go to the Bluetooth Support page at www.apple.com/support/bluetooth . Or open the Bluetooth File Exchange application, located in the Utilities folder within the Applications folder, and choose Help > Bluetooth Help.
Caring for the battery	Search for "battery" in Mac Help.
Connecting a printer	Search for "printing" in Mac Help.
FireWire and USB connections	Search for "USB" or "FireWire" in Mac Help.
Connecting to the Internet	Search for "Internet" in Mac Help.
Connecting an external display	Search for "display port" in Mac Help.
Apple Remote (sold separately at www.apple.com/store)	Search for "remote" in Mac Help.
Front Row	Search for "Front Row" in Mac Help.
Burning a CD or DVD	Search for "burn disc" in Mac Help.
Specifications	Go to the Specifications page at support.apple.com/specs . Or open System Profiler by choosing Apple () > About This Mac from the menu bar, and then click More Info.
Apple news, free downloads, and online catalogs of software and hardware	Go to the Apple website at www.apple.com .
Instructions, technical support, and manuals for Apple products	Go to the Apple Support website at www.apple.com/support .

3

Boost Your Memory

www.apple.com/store

Mac Help  RAM

This chapter provides information and instructions for installing additional memory and for removing and replacing the battery in your MacBook Pro.

Your computer has two memory slots that you access by removing the memory door in the battery bay. Your MacBook Pro comes with a minimum of 2 gigabytes (GB) of 667 MHz Double Data Rate (DDR2) Synchronous Dynamic Random-Access Memory (SDRAM) installed. Both memory slots can accept an SDRAM module that meets the following specifications:

- Double Data Rate Small Outline Dual Inline Memory Module (DDR SO-DIMM) format
- 1.25 inch or smaller
- 1 GB or 2 GB
- 200-pin
- PC2-5300 DDR2 667 MHz Type RAM

You can add two 2 GB memory modules for a maximum of 4 GB of memory.

WARNING: Apple recommends that you have an Apple-certified technician install memory. Consult the service and support information that came with your computer for information about how to contact Apple for service. If you attempt to install memory and damage your equipment, such damage is not covered by the limited warranty on your computer.

Installing Additional Memory

Installing memory involves removing and replacing the battery. The following procedure includes instructions for removing the battery, adding memory, and replacing the battery.

Step 1: Remove the battery.

- 1 Shut down your MacBook Pro. Disconnect the power adapter, Ethernet cable, and any other cords connected to the MacBook Pro to prevent damaging the computer.

WARNING: Use care when handling the battery. See the battery safety information on page 64.

- 2 Turn over the MacBook Pro and locate the release latches on either side of the battery. Slide both latches up. The battery should pop up slightly. Lift it out.

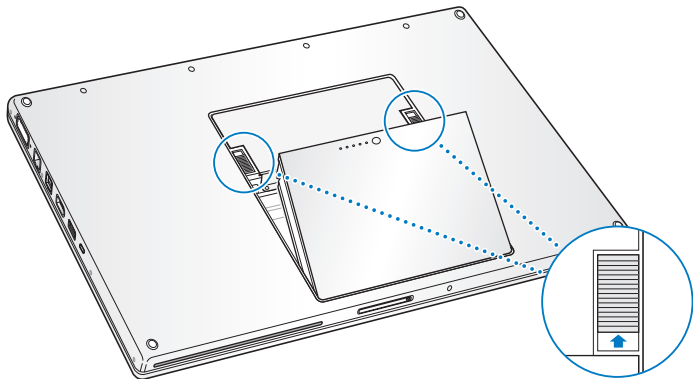

WARNING: The internal components of your MacBook Pro can be warm. If you have been using your MacBook Pro, wait 10 minutes after shutting it down to let the internal components cool before continuing.

Step 2: Install memory.

- 1 Using a Phillips #00 screwdriver, unscrew the screws holding the memory door and remove it from the battery bay of the computer. Depending on the model of your MacBook Pro, you may have three or four screws.

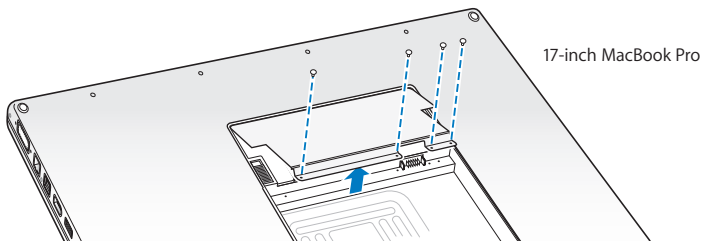
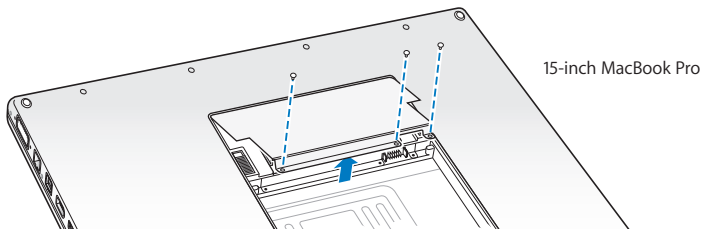

- 2 Touch a metal surface inside the computer to discharge any static electricity from your body.

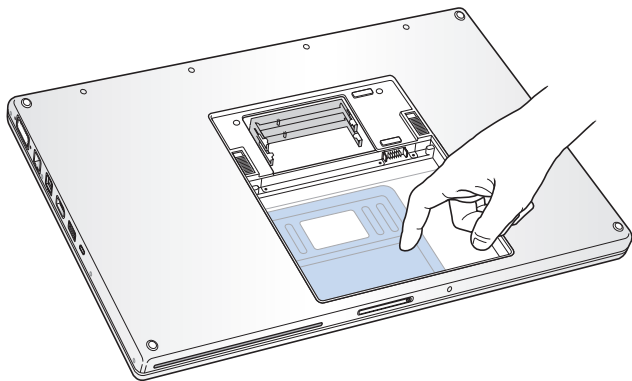

- 3 If you need to remove a memory card that's already installed in the slot, spread the tabs in the slot away from the notches in the memory card. The card should pop up slightly. Lift the memory card to a 25-degree angle and then gently slide the card out of the memory slot.

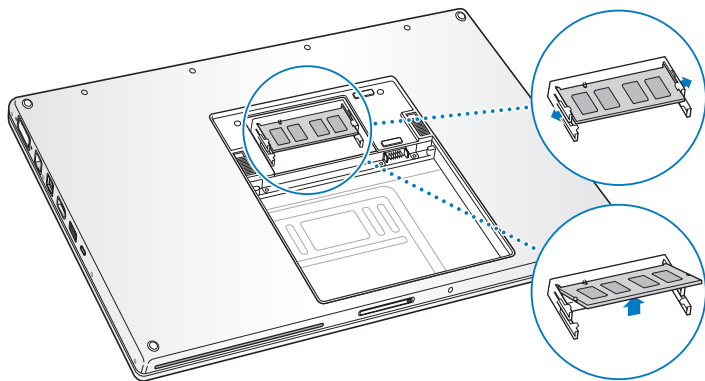

- 4 Insert the memory card at a 25-degree angle. Line up the notch in the card with the small tab in the memory slot and slide the card into the slot until the gold edge is almost invisible. Then firmly push the memory card into the memory slot. You might feel some resistance.

- 5 Gently spread the small tabs in the memory slot away from the notches and push the memory card down until the two snaps on either side of the card lock into place.

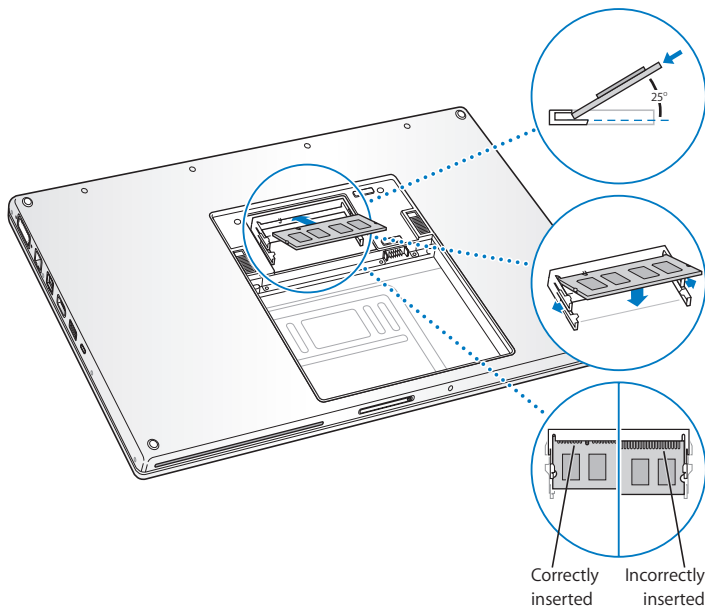

Note: Make sure your memory is installed according to this illustration, so the gold contacts are almost completely inserted into the connector.

- 6 Insert any additional memory in the second slot.
- 7 Replace the memory door and make sure it is lying flat before tightening the screws into place.

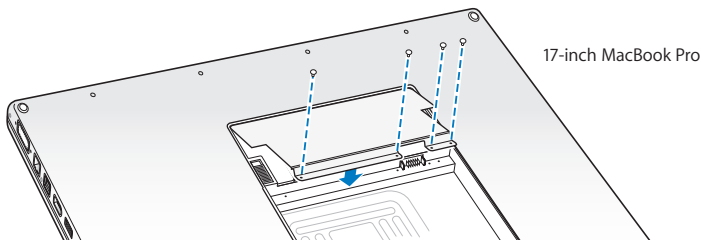
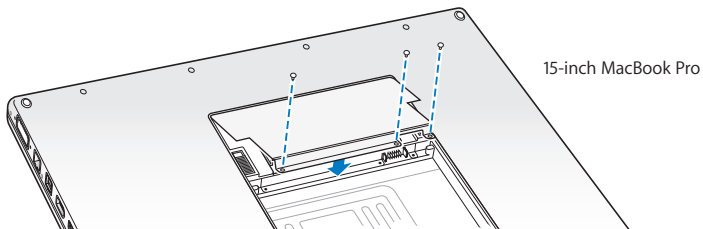

Step 3: Replace the battery.

- 1 Place the bottom edge of the battery in the battery compartment. Gently press the top edge of the battery down until the battery latches lock into place.

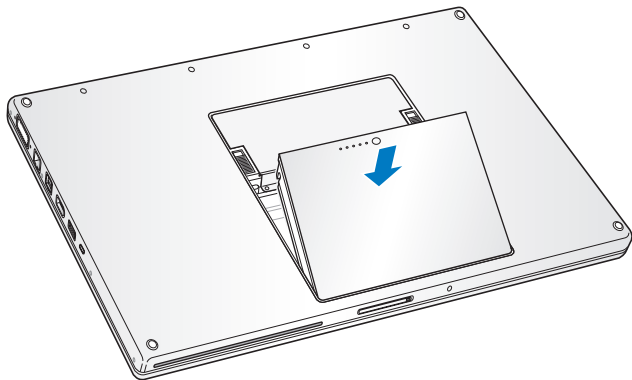

- 2 Reconnect the power adapter and any other cables that were attached.

Making Sure Your MacBook Pro Recognizes the New Memory

After installing additional memory in your MacBook Pro, check whether the computer recognizes the new memory.

To check the computer's memory:

- 1 Start up your MacBook Pro.
- 2 When you see the Mac OS X desktop, choose Apple () from the menu bar and then choose About This Mac.

The total memory includes the amount of memory that originally came with the computer plus the new memory you added. For a detailed breakdown of the amount of memory installed in your computer, open System Profiler by clicking More Info and then Memory.

If your MacBook Pro doesn't recognize the memory or doesn't start up correctly, confirm that the memory you installed is compatible with your MacBook Pro and that it is installed correctly by reseating the memory.

4

Problem, Meet Solution

www.apple.com/support

Mac Help  help

Occasionally you may have problems while working with your MacBook Pro. Read on to find some solutions to try when you have a problem. You can also find more troubleshooting information in Mac Help and on the MacBook Pro Support website at www.apple.com/support/macbookpro.

When you experience a problem working with your MacBook Pro, there is usually a simple and quick solution. Think about the conditions that led up to the problem. Making a note of things you did before the problem occurred will help you narrow down possible causes and find the answers you need. Things to note include:

- The applications you were using when the problem occurred. Problems that occur only with a specific application might indicate that the application is not compatible with the version of the Mac OS installed on your computer.
- Any new software that you installed, especially software that added items to the System folder.
- Any new hardware that you installed, such as additional memory or a peripheral.

Problems That Prevent You from Using Your MacBook Pro

If your MacBook Pro doesn't respond or the pointer doesn't move

On rare occasions, an application may “freeze” on the screen. Mac OS X provides a way to quit a frozen application and save your work in other open applications without restarting your computer.

To force an application to quit:

- 1 Press Command (⌘)-Option-Esc or choose Apple () > Force Quit from the menu bar. The Force Quit Applications dialog appears with the application selected.

2 Click Force Quit.

The application quits, leaving all other applications open.

If you need to, you can also restart the Finder from this dialog.

Next, save your work in any open applications and restart the computer to make sure the problem is entirely cleared up.

If you are unable to force the application to quit, press and hold the power (⏻) button for a few seconds until the computer shuts itself down. Wait 10 seconds, and then turn on the computer.

If the problem occurs frequently, choose Help > Mac Help from the menu bar at the top of the screen. Search for the word “freeze” to get help for instances when the computer freezes or doesn’t respond.

If the problem occurs only when you use a particular application, check with the application’s manufacturer to see if it is compatible with your computer. To get support and contact information for the software that comes with your MacBook Pro, go to www.apple.com/guide.

If you know an application is compatible, you might need to reinstall your computer’s system software. See “Reinstalling the Software That Came with Your MacBook Pro” on page 56.

If your MacBook Pro freezes during startup, or you see a flashing question mark, or the display is dark and the sleep indicator light is glowing steadily (not in sleep)

The flashing question mark usually means that the computer can't find the system software on the hard disk or any disks attached to the computer.

- Wait a few seconds. If the computer doesn't soon start up, shut it down by pressing and holding the power (⏻) button for about 8 to 10 seconds. Disconnect all external peripherals and try restarting by pressing the power (⏻) button while holding down the Option key. When your computer starts up, click the hard disk icon, and then click the right arrow. After the computer starts up, open System Preferences and click Startup Disk. Select a local Mac OS X System folder.
- If that doesn't work, try using Disk Utility to repair the disk:
 - Insert the Mac OS X Install Disc 1 into your computer.
 - Restart your computer and hold down the C key as it starts up.
 - Choose Installer from the menu bar, and then choose Open Disk Utility. When Disk Utility opens, follow the instructions in the First Aid pane to see if Disk Utility can repair the disk.

If using Disk Utility doesn't help, you might need to reinstall your computer's system software. See "Reinstalling the Software That Came with Your MacBook Pro" on page 56.

If your MacBook Pro doesn't turn on or start up

Try the following suggestions in order until your computer turns on:

- Make sure the power adapter is plugged into the computer and into a functioning power outlet. Be sure to use the 85W MagSafe Power Adapter that came with your MacBook Pro. If the power adapter stops charging and you don't see the indicator light on the MagSafe connector turn on when you plug in the power cord, try unplugging and replugging the power cord to reset it, or try another power outlet.
- Check whether the battery needs to be recharged. Press the small button on the battery. You should see one to four lights indicating the battery's level of charge. If a single indicator light is flashing, allow the power adapter to charge the battery at least until that indicator light is glowing continuously.
- If the problem persists, reset the MacBook Pro power manager by disconnecting the power adapter, removing the battery, and holding down the power (⏻) button for at least 5 seconds.
- If you recently installed additional memory, make sure that it is correctly installed and that it is compatible with your computer. See whether removing and reinstalling the old memory allows the computer to start up (see "Installing Additional Memory" on page 35).
- Press the power (⏻) button and immediately hold down the Command (⌘), Option, P, and R keys simultaneously until you hear the startup sound a second time to reset the parameter RAM (PRAM).
- If you still can't start up your MacBook Pro, see "Learning More, Service, and Support" on page 57 for information about contacting Apple for service.

If the display suddenly goes black or your MacBook Pro freezes

Try restarting your MacBook Pro.

- 1 Unplug any devices that are connected to your MacBook Pro, except the power adapter.
- 2 Press the power (⏻) button to restart the system.
- 3 Let the battery charge to at least 10 percent before plugging in any external devices and resuming your work.

To see how much the battery has charged, click the Battery (🔋) status icon in the menu bar.

The display might also darken if you have energy saver features set for the battery.

If you forgot your password

You can reset your administrator password and passwords for all other accounts.

- 1 Insert the Mac OS X Install Disc 1. Then restart your computer and hold down the C key as it starts up.
- 2 Choose Utilities > Reset Password from the menu bar and follow the onscreen instructions.

If you have trouble ejecting a disc

- Quit any applications that might be using the disc and try again. If that doesn't work, restart the computer and then immediately press and hold the trackpad button.

Using Apple Hardware Test

If you suspect a problem with the MacBook Pro hardware, you can use the Apple Hardware Test application to help determine if there is a problem with one of the computer's components, such as the memory or processor.

To use Apple Hardware Test:

- 1 Disconnect all external devices from your computer except the power adapter.
If you have an Ethernet cable connected, disconnect it.
- 2 Restart your computer and hold down the D key as it starts up.
- 3 When the Apple Hardware Test chooser screen appears, select the language for your location.
- 4 Press the Return key or click the right arrow button.
- 5 When the Apple Hardware Test main screen appears (after about 45 seconds), follow the onscreen instructions.
- 6 If Apple Hardware Test detects a problem, it displays an error code. Make a note of the error code before pursuing support options. If Apple Hardware Test doesn't detect a hardware failure, the problem might be software related.

For more information about Apple Hardware Test, see the Apple Hardware Test Read Me file on the Mac OS X Install Disc 1.

Problems with Your Internet Connection

Your MacBook Pro has the Setup Assistant application to help walk you through setting up an Internet connection. Open System Preferences and click Network. Click the "Assist me" button to open Network Setup Assistant.

If you have trouble with your Internet connection, you can try the steps in this section for your type of connection or you can use Network Diagnostics.

To use Network Diagnostics:

- 1 Choose Apple (🍏) > System Preferences.
- 2 Click Network and then click “Assist me.”
- 3 Click Diagnostics to open Network Diagnostics.
- 4 Follow the onscreen instructions.

If Network Diagnostics can't resolve the problem, there may be a problem with the Internet service provider (ISP) you are trying to connect to, with an external device you are using to connect to your ISP, or with the server you are trying to access. You can try the following steps.

Cable Modem, DSL Modem, and LAN Internet Connections

Make sure all modem cables are firmly plugged in, including the modem power cord, the cable from the modem to the computer, and the cable from the modem to the wall jack. Also check the cables and power supplies to Ethernet hubs and routers.

Turn the modem off and on and reset the modem hardware

Turn off your DSL or cable modem for a few minutes, and then turn it back on. Some ISPs recommend that you unplug the modem's power cord. If your modem has a reset button, you can press it either before or after you turn the power off and on.

Important: Instructions that refer to modems do not apply to LAN users. LAN users might have hubs, switches, routers, or connection pods that DSL and cable modem users do not have. LAN users should contact their network administrator rather than an ISP.

PPPoE Connections

If you are unable to connect to your Internet service provider using PPPoE (Point to Point Protocol over Ethernet), make sure you have entered the correct information in Network preferences.

To check your Network preference settings:

- 1 Choose Apple (🍏) > System Preferences.
- 2 Click Network.
- 3 Click Add (+) at the bottom of the network connection services list, and choose PPPoE from the Interface pop-up menu.
- 4 Choose an Interface for the PPPoE service from the Ethernet pop-up menu. Choose Ethernet if you are connecting to a wired network or AirPort if you are connecting to a wireless network.
- 5 Enter the information you received from your service provider, such as account name, password, and the PPPoE service name (if your service provider requires it).
- 6 Click Apply to make the settings active.

Network Connections

Make sure the Ethernet cable is plugged into your MacBook Pro and into the network. Check the cables and power supplies to your Ethernet hubs and routers.

If you have two or more computers attempting to share an Internet connection, be sure that your network is set up properly. You need to know whether your ISP provides only one IP address or multiple IP addresses, one for each computer.

If only one IP address is provided, then you must have a router capable of sharing the connection, also known as network address translation (NAT) or “IP masquerading.” For setup information, check the documentation provided with your router or ask the person who set up your network. The AirPort Base Station can be used to share one IP address among multiple computers. For information about using an AirPort Base Station, check Mac Help or visit the AirPort Extreme website at www.apple.com/support/airport.

If you can't resolve the issue using these steps, contact your ISP or network administrator.

Problems with AirPort Extreme Wireless Communication

If you have trouble using AirPort Extreme wireless communication

- Make sure the computer or network you are trying to connect to is running and has a wireless access point.
- Make sure you have properly configured the software according to the instructions that came with your base station or access point.
- Make sure you are within antenna range of the other computer or the network's access point. Nearby electronic devices or metal structures can interfere with wireless communication and reduce this range. Repositioning or rotating the computer might improve reception.
- Check the AirPort (📶) status icon in the menu bar. Up to four bars appear, indicating signal strength. If you don't see the bars, try changing your location.

- See AirPort Help (choose Help > Mac Help, and then choose Library > AirPort Help from the menu bar). Also see the instructions that came with the wireless device for more information.

Keeping Your Software Up to Date

You can connect to the Internet and automatically download and install the latest free software versions, drivers, and other enhancements from Apple.

When you are connected to the Internet, Software Update checks to see if any updates are available for your computer. You can set your MacBook Pro to check for updates periodically, and then you can download and install updated software.

To check for updated software:

- 1 Choose Apple () > System Preferences.
- 2 Click the Software Update icon and follow the instructions on the screen.
 - For more information, search for “Software Update” in Mac Help.
 - For the latest information about Mac OS X, go to www.apple.com/macosx.

Reinstalling the Software That Came with Your MacBook Pro

Use the software installation discs that came with your computer to reinstall Mac OS X and any applications that came with your computer.

Important: Apple recommends that you back up the data on your hard disk before reinstalling software. Apple is not responsible for any lost data.

Installing Mac OS X and Applications

To install Mac OS X and the applications that came with your MacBook Pro:

- 1 Back up your essential files.

Because the Erase and Install option erases your hard disk, you should back up your essential files before installing Mac OS X and other applications.

- 2 Make sure your power adapter is connected, plugged in, and the light is on.

- 3 Insert the Mac OS X Install Disc 1 that came with your computer.

- 4 Double-click Install Mac OS X and Bundled Software. To install only the applications that came with your computer, double-click Bundled Software Only.

Note: To install iCal, iChat AV, iSync, iTunes, Safari, and the iLife '08 applications, double-click "Install Mac OS X and Bundled Software."

- 5 Follow the onscreen instructions.

- 6 After selecting the destination volume for installation, continue following the onscreen instructions. Your computer might restart and ask you to insert the next Mac OS X installation disc.

Note: To restore Mac OS X on your computer to the original factory settings, click Options in the Select a Destination pane of the Installer, and then select Erase and Install.

Learning More, Service, and Support

Your MacBook Pro does not have any user-serviceable parts, except the memory. If you need service, contact Apple or take your MacBook Pro to an Apple Authorized Service Provider. You can find more information about the MacBook Pro through online resources, onscreen help, System Profiler, or Apple Hardware Test.

Online Resources

For online service and support information, go to www.apple.com/support. Choose your country from the pop-up menu. You can search the AppleCare Knowledge Base, check for software updates, or get help from Apple's discussion forums.

Onscreen Help

You can look for answers to your questions, as well as instructions and troubleshooting information, in Mac Help. Choose Help > Mac Help.

System Profiler

To get information about your MacBook Pro, use System Profiler. It shows you what hardware and software is installed, the serial number and operating system version, how much memory is installed, and more. To open System Profiler, choose Apple () > About This Mac from the menu bar and then click More Info.

AppleCare Service and Support

Your MacBook Pro comes with 90 days of technical support and one year of hardware repair warranty coverage at an Apple Store retail location or an Apple-authorized repair center, such as an Apple Authorized Service Provider. You can extend your coverage by purchasing the AppleCare Protection Plan. For information, visit www.apple.com/support/products or visit the website address for your country listed below.

If you need assistance, AppleCare telephone support representatives can help you with installing and opening applications, and basic troubleshooting. Call the support center number nearest you (the first 90 days are complimentary). Have the purchase date and your MacBook Pro serial number ready when you call.

Note: Your 90 days of complimentary telephone support begins on the date of purchase. Telephone fees may apply.

Country	Phone	Website
United States	1-800-275-2273	www.apple.com/support
Australia	(61) 133-622	www.apple.com/au/support
Canada (English) (French)	1-800-263-3394	www.apple.com/ca/support www.apple.com/ca/fr/support
Ireland	(353) 1850 946 191	www.apple.com/ie/support
New Zealand	00800-7666-7666	www.apple.com/nz/support
United Kingdom	(44) 0870 876 0753	www.apple.com/uk/support

Telephone numbers are subject to change, and local and national telephone rates may apply. A complete list is available on the web:

www.apple.com/contact/phone_contacts.html

Locating Your Product Serial Number

Use one of these methods to find your computer's serial number:

- Choose Apple (🍏) from the menu bar and then choose About This Mac. Click the version number beneath the words "Mac OS X" to cycle through the Mac OS X version number, the build version, and the serial number.
- Click the Finder icon and open /Applications/Utilities/System Profiler. Click Hardware in the Contents panel.
- Remove the battery and view the serial number for your MacBook Pro in the battery bay. For information about removing the battery, see page 35.

5

Last, but Not Least

www.apple.com/environment

Mac Help  ergonomics

For your safety and that of your equipment, follow these rules for handling and cleaning your MacBook Pro and for working more comfortably. Keep these instructions handy for reference by you and others.

Important Safety Information

WARNING: Failure to follow these safety instructions could result in fire, electric shock, or other injury or damage.

Avoiding water and wet locations Keep your MacBook Pro away from sources of liquid, such as drinks, washbasins, bathtubs, shower stalls, and so on. Protect your MacBook Pro from dampness or wet weather, such as rain, snow, and fog.

Handling your MacBook Pro Set up your MacBook Pro on a stable work surface that allows for adequate air circulation under and around the computer. Do not operate your MacBook Pro on a pillow or other soft material, as the material can block the airflow vents. Never place anything over the keyboard when operating your MacBook Pro. Never push objects into the ventilation openings.

The bottom of your MacBook Pro may become very warm during normal use. If your MacBook Pro is on your lap and gets uncomfortably warm, remove it from your lap and place it on a stable work surface.

Using the 85W MagSafe Power Adapter Make sure the AC plug or AC power cord is fully inserted into the power adapter before plugging the adapter into a power outlet. Use only the power adapter that came with your MacBook Pro, or an Apple-authorized power adapter that is compatible with this product. The power adapter may become very warm during normal use. Always plug the power adapter directly into a power outlet, or place it on the floor in a well-ventilated location.

Disconnect the power adapter, remove the battery, and disconnect any other cables if any of the following conditions exists:

- You want to add memory.
- You want to clean the case (use only the recommended procedure described on page 66).
- The power cord or plug becomes frayed or otherwise damaged.
- Your MacBook Pro or power adapter is exposed to rain, excessive moisture, or liquid spilled into the case.
- Your MacBook Pro or power adapter has been dropped, the case has been damaged, or you suspect that service or repair is required.

The MagSafe power port contains a magnet that can erase data on a credit card, iPod, or other device. To preserve your data, do not place these or other magnetically sensitive material or devices within 1 inch (25 mm) of this port.

If debris gets into the MagSafe power port, remove it gently with a dry cotton swab.

Handling the battery Do not drop, disassemble, crush, incinerate, or expose the battery to temperatures above 212° F (100° C). Stop using the battery if it appears damaged in any way. Replace the battery only with an Apple-authorized battery for this product. Dispose of used batteries promptly according to your local environmental guidelines.

Avoiding hearing damage Permanent hearing loss may occur if earbuds or headphones are used at high volume. You can adapt over time to a higher volume of sound that may sound normal but can be damaging to your hearing. If you experience ringing in your ears or muffled speech, stop listening and have your hearing checked. The louder the volume, the less time is required before your hearing could be affected. Hearing experts suggest that to protect your hearing:

- Limit the amount of time you use earbuds or headphones at high volume.
- Avoid turning up the volume to block out noisy surroundings.
- Turn the volume down if you can't hear people speaking near you.

High-risk activities This computer system is not intended for use in the operation of nuclear facilities, aircraft navigation or communications systems, air traffic control systems, or for any other uses where the failure of the computer system could lead to death, personal injury, or severe environmental damage.

Laser Information for Optical Disc Drives

WARNING: Making adjustments or performing procedures other than those specified in your equipment's manual may result in hazardous radiation exposure.

The optical disc drive in your computer contains a laser that is safe in normal use but that may be harmful to your eyes if disassembled. For your safety, have this equipment serviced only by an Apple Authorized Service Provider.

Important Handling Information

NOTICE: Failure to follow these handling instructions could result in damage to your MacBook Pro or other property.

Turning on your MacBook Pro Never turn on your MacBook Pro unless all of its internal and external parts are in place. Operating the computer when parts are missing may be dangerous and may damage your computer.

Carrying your MacBook Pro If you carry your MacBook Pro in a bag or briefcase, make sure that there are no loose items (such as paper clips or coins) that could accidentally get inside the computer through vent openings or the optical drive slot or get stuck inside a port. Also, keep magnetically sensitive items away from the MagSafe power port.

Using connectors and ports Never force a connector into a port. When connecting a device, make sure the port is free of debris, that the connector matches the port, and that you have positioned the connector correctly in relation to the port.

Using the optical drive The SuperDrive in your MacBook Pro supports standard 12 cm (4.7 inch) discs. Irregularly shaped discs or discs smaller than 12 cm (4.7 inches) are not supported.

Storing your MacBook Pro If you are going to store your MacBook Pro for an extended period of time, keep it in a cool location (ideally, 71° F or 22° C) and discharge the battery to 50 percent. When storing your MacBook Pro for longer than five months, discharge the battery to approximately 50 percent and then remove it from your MacBook Pro. To maintain the capacity of the battery, recharge the battery to 50 percent every six months or so.

Cleaning your MacBook Pro When cleaning the outside of your MacBook Pro and its components, first shut down your MacBook Pro, unplug the power adapter, and remove the battery. Then use a damp, soft, lint-free cloth to clean the computer's exterior. Avoid getting moisture in any openings. Do not spray liquid directly on the computer. Do not use aerosol sprays, solvents, or abrasives that might damage the finish.

Cleaning your MacBook Pro display To clean your MacBook Pro screen, first shut down your MacBook Pro, unplug the power adapter, and remove the battery. Then dampen the included cleaning cloth with just water and wipe the screen. Do not spray liquid directly on the screen.

Understanding Ergonomics

Here are some tips for setting up a healthy work environment.

Keyboard and Trackpad

When you use the keyboard and trackpad, your shoulders should be relaxed. Your upper arm and forearm should form an angle that is slightly greater than a right angle, with your wrist and hand in roughly a straight line.

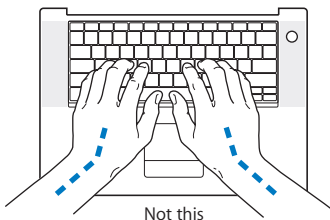
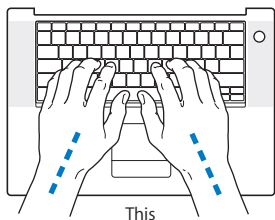

Use a light touch when typing or using the trackpad and keep your hands and fingers relaxed. Avoid rolling your thumbs under your palms.

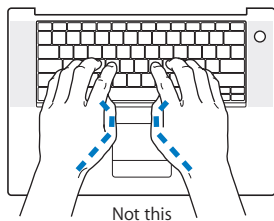
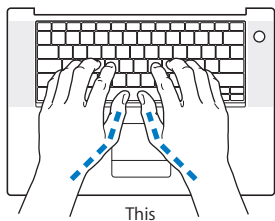

Change hand positions often to avoid fatigue. Some computer users might develop discomfort in their hands, wrists, or arms after intensive work without breaks. If you begin to develop chronic pain or discomfort in your hands, wrists, or arms, consult a qualified health specialist.

External Mouse

If you use an external mouse, position the mouse at the same height as the keyboard and within a comfortable reach.

Chair

An adjustable chair that provides firm, comfortable support is best. Adjust the height of the chair so your thighs are horizontal and your feet are flat on the floor. The back of the chair should support your lower back (lumbar region). Follow the manufacturer's instructions for adjusting the backrest to fit your body properly.

You might have to raise your chair so that your forearms and hands are at the proper angle to the keyboard. If this makes it impossible to rest your feet flat on the floor, you can use a footrest with adjustable height and tilt to make up for any gap between the floor and your feet. Or you can lower the desktop to eliminate the need for a footrest. Another option is to use a desk with a keyboard tray that's lower than the regular work surface.

Built-in Display

Adjust the angle of the display to minimize glare and reflections from overhead lights and windows. Do not force the display if you meet resistance. The display is not meant to open past 130 degrees.

You can adjust the brightness of the screen when you take the computer from one work location to another, or if the lighting in your work area changes.

More information about ergonomics is available on the web:

www.apple.com/about/ergonomics

Apple and the Environment

Apple Inc. recognizes its responsibility to minimize the environmental impacts of its operations and products.

More information is available on the web:

www.apple.com/environment

Regulatory Compliance Information

Compliance Statement

This device complies with part 15 of the FCC rules.

Operation is subject to the following two conditions: (1)

This device may not cause harmful interference, and (2) this device must accept any interference received, including interference that may cause undesired operation. See instructions if interference to radio or television reception is suspected.

L'utilisation de ce dispositif est autorisée seulement aux conditions suivantes: (1) il ne doit pas produire de brouillage et (2) l'utilisateur du dispositif doit être prêt à accepter tout brouillage radioélectrique reçu, même si ce brouillage est susceptible de compromettre le fonctionnement du dispositif.

Radio and Television Interference

This computer equipment generates, uses, and can radiate radio-frequency energy. If it is not installed and used properly—that is, in strict accordance with Apple's instructions—it may cause interference with radio and television reception.

This equipment has been tested and found to comply with the limits for a Class B digital device in accordance with the specifications in Part 15 of FCC rules. These specifications are designed to provide reasonable protection against such interference in a residential installation. However, there is no guarantee that interference will not occur in a particular installation.

You can determine whether your computer system is causing interference by turning it off. If the interference stops, it was probably caused by the computer or one of the peripheral devices.

If your computer system does cause interference to radio or television reception, try to correct the interference by using one or more of the following measures:

- Turn the television or radio antenna until the interference stops.
- Move the computer to one side or the other of the television or radio.
- Move the computer farther away from the television or radio.
- Plug the computer into an outlet that is on a different circuit from the television or radio. (That is, make certain the computer and the television or radio are on circuits controlled by different circuit breakers or fuses.)

If necessary, consult an Apple Authorized Service Provider or Apple. See the service and support information that came with your Apple product. Or consult an experienced radio/television technician for additional suggestions.

Important: Changes or modifications to this product not authorized by Apple Inc. could void the EMC compliance and negate your authority to operate the product.

This product has demonstrated EMC compliance under conditions that included the use of compliant peripheral devices and shielded cables (including Ethernet network cables) between system components. It is important that you use compliant peripheral devices and shielded cables between system components to reduce the possibility of causing interference to radios, television sets, and other electronic devices.

Responsible party (contact for FCC matters only):

Apple Inc. Corporate Compliance
1 Infinite Loop, M/S 26-A
Cupertino, CA 95014-2084

Wireless Radio Use

This device is restricted to indoor use when operating in the 5.15 to 5.25 GHz frequency band.

Cet appareil doit être utilisé à l'intérieur.

Exposure to Radio Frequency Energy

The radiated output power of the AirPort Extreme technology is below the FCC radio frequency exposure limits. Nevertheless, it is advised to use the wireless equipment in such a manner that the potential for human contact during normal operation is minimized.

FCC Bluetooth Wireless Compliance

The antenna used with this transmitter must not be colocated or operated in conjunction with any other antenna or transmitter subject to the conditions of the FCC Grant.

Bluetooth Industry Canada Statement

This Class B device meets all requirements of the Canadian interference-causing equipment regulations.

Cet appareil numérique de la Class B respecte toutes les exigences du Règlement sur le matériel brouilleur du Canada.

Industry Canada Statement

Complies with the Canadian ICES-003 Class B specifications. Cet appareil numérique de la classe B est conforme à la norme NMB-003 du Canada. This device complies with RSS 210 of Industry Canada.

Bluetooth Europe—EU Declaration of Conformity

This wireless device complies with the R&TTE Directive.

Europe—EU Declaration of Conformity

See <http://www.apple.com/euro/compliance>

Korea Statements

“당해 무선설비는 운용 중 전파혼신 가능성이 있음”

“이 기기는 인명안전과 관련된 서비스에 사용할 수 없습니다”

B급 기기 (가정용 정보통신기기)

이 기기는 가정용으로 전자파적합등록을 한 기기로서 주거지역에서는 물론 모든지역에서 사용할 수 있습니다.

Singapore Wireless Certification

Complies with IDA Standards DB00063

Taiwan Wireless Statements

於 2.4GHz 區域內操作之 無線設備的警告聲明

經型式認證合格之低功率射頻電機，非經許可，公司、商號或使用者均不得擅自變更頻率、加大功率或變更原設計之特性及功能。低功率射頻電機之使用不得影響飛航安全及干擾合法通信；經發現有干擾現象時，應立即停用，並改善至無干擾時方得繼續使用。前項合法通信指依電信法規定作業之無線電通信。低功率射頻電機須忍受合法通信或工業、科學及醫療用電波輻射性電機設備之干擾。

於 5.25GHz 至 5.35GHz 區域內操作之 無線設備的警告聲明

工作頻率 5.250 ~ 5.350GHz 該頻段限於室內使用。

Taiwan Class B Statement

Class B 設備の警告聲明
NIL

VCCI Class B Statement

情報処理装置等電波障害自主規制について

この装置は、情報処理装置等電波障害自主規制協議会 (VCCI) の基準に基づくクラス B 情報技術装置です。この装置は家庭環境で使用されることを目的としていますが、この装置がラジオやテレビジョン受信機に近接して使用されると、受信障害を引き起こすことがあります。

取扱説明書に従って正しい取扱をしてください。

External USB Modem Information

When connecting your MacBook Pro to the phone line using an external USB modem, refer to the telecommunications agency information in the documentation that came with your modem.

ENERGY STAR® Compliance



As an ENERGY STAR® partner, Apple has determined that standard configurations of this product meet the ENERGY STAR® guidelines for energy efficiency. The ENERGY STAR® program is a partnership with electronic equipment manufacturers to promote energy-efficient products. Reducing energy consumption of products saves money and helps conserve valuable resources. This computer is shipped with power management enabled with the computer set to sleep after 10 minutes of user inactivity. To wake your computer, click the mouse or trackpad button or press any key on the keyboard.

For more information about ENERGY STAR®, visit:
www.energystar.gov

中国

有毒或 有害物质	零部件				
	电路板	显示屏	电池组	附件	电源 适配器
铅 (Pb)	X	X	X	X	X
汞 (Hg)	O	15 英寸 O 17 英寸 X 17 英寸 (高分 辨率) O	O	O	O
镉 (Cd)	O	O	O	O	O
六价铬 (Cr, VI)	O	O	O	O	O
多溴联苯 (PBB)	O	O	O	O	O
多溴二苯醚 (PBDE)	O	O	O	O	O

O: 表示该有毒有害物质在该部件所有均质材料中的含量均在 SJ/T 11363-2006 规定的限量要求以下。

X: 表示该有毒有害物质至少在该部件的某一均质材料中的含量超出 SJ/T 11363-2006 规定的限量要求。

根据中国电子行业标准 SJ/T11364-2006 和相关的中国政府法规, 本产品及其某些内部或外部组件上可能带有环保使用期限标识。取决于组件和组件制造商, 产品及其组件上的使用期限标识可能有所不同。产品上如有任何互相冲突或不同的环保使用期限标识, 以组件上的使用期限标识为准。

Disposal and Recycling Information



This symbol indicates that your product must be disposed of properly according to local laws and regulations. Because the backlight lamp in the standard resolution 17-inch MacBook Pro contains mercury, the product must be disposed of separately from household waste. When your product reaches its end of life, contact Apple or your local authorities to learn about recycling options.

For information about Apple's recycling program, go to www.apple.com/environment/recycling.

Battery Disposal Information

Dispose of batteries according to your local environmental laws and guidelines.

California: The coin cell battery in your product contains perchlorates. Special handling and disposal may apply. Refer to www.dtsc.ca.gov/hazardouswaste/perchlorate.

Deutschland: Dieses Gerät enthält Batterien. Bitte nicht in den Hausmüll werfen. Entsorgen Sie dieses Gerätes am Ende seines Lebenszyklus entsprechend der maßgeblichen gesetzlichen Regelungen.

Nederlands: Gebruikte batterijen kunnen worden ingeleverd bij de chemokar of in een speciale batterijcontainer voor klein chemisch afval (kca) worden gedeponeerd.



Taiwan:



廢電池請回收

European Union — Disposal Information:



The symbol above means that according to local laws and regulations your product should be disposed of separately from household waste. When this product reaches its end of life, take it to a collection point designated by local authorities. Some collection points accept products for free. The separate collection and recycling of your product at the time of disposal will help conserve natural resources and ensure that it is recycled in a manner that protects human health and the environment.

Looking for Something?

Index

A

AC power adapter. *See* power adapter

AirPort Extreme
 problems 54
 using 31

AppleCare 58

Apple Hardware Test 51

Apple Remote 32

application freeze 46

applications

 Front Row 21, 32

 iChat AV 21

 iLife 31

 Keynote 21

 Photo Booth 21

audio line in port 25

B

battery

 disposal 73

 general information 28

 indicator lights 28

 location 19

 removing 35

 replacing 42

 storing 66

blinking question mark 48

brightness controls 23

built-in speakers 21

button, power 12, 19

C

cable modem 11

camera. *See* iSight

carrying your computer 65

changing

 the desktop 15

 password 50

 System Preferences 15

checking memory 43

cleaning

 the display 66

 your computer 66

computer

 freezes 48

 inventory 9

 turning on 12

 won't turn on 49

connecting to a network 11

Control-click 26

controls

 brightness 23

 keyboard 23

 volume 23

cord, power 10

D

Dashboard 23

desktop, customizing 15

discs, supported 66

display

 cleaning 66

 goes black 50

 release button 19

disposing of batteries 73

disposing of your computer 73

Dock 30

downloading software 55

drive, optical 19

DSL modem 11

DVI port 25

E

ejecting a disc 50

Energy Saver preferences 29

environmental impact 69

ergonomics 67

Ethernet

 connecting to 11

 port 25

Exposé All Windows key 23
ExpressCard slot 25
external display port 25
external modem 12

F

F1 to F12 function keys 23
Fast-forward key 23
FireWire
 connections 32
 port 25
flashing question mark 48
Fn (Function) key 23
Force Quit 46
forward delete 26
Front Row application 21, 32
frozen application 46

H

hand positions 67
headphone port 25
Help, finding answers 30
high-speed USB 25

I

iChat AV application 21
iLife applications 31
infrared (IR) receiver 21
installation instructions
 additional RAM 35
 memory 35
 overview 8

Internet
 connecting 11
 connection problems 51
inventory of items 9
IP address, sharing 53
IP masquerading 54
iSight video camera 21

K

keyboard
 ergonomics 67
 features 23
 illumination controls 23
 media control keys 23
 shortcuts 26
Keynote application 21
keys
 Dashboard 23
 Exposé 23
 media 23

M

Mac Help 30
Mac OS X
 reinstalling 56
 website 31
MagSafe power adapter. *See*
 power adapter
media controls 23
Media Eject key 23
memory
 checking 43

installing 34, 35
 specifications 34
mercury 73
microphone 21
Migration Assistant 13
modem 11
mouse 25, 68
Mute control 23

N

network address translation
 (NAT) 54
network connections 53
Network Diagnostics 52
Network Setup Assistant 51
number, serial 59

O

online resources 57
optical digital audio ports 25
optical drive
 about 19
 supported disc sizes 66

P

paging through documents
 using trackpad 28
password, resetting 50
Photo Booth application 21
pinching to zoom 19, 27
Play/Pause key 23
ports on MacBook Pro 25

- power adapter
 - plugging in 63
 - port 25
 - using 10
- power button 12, 19
- power cord 10
- PPPoE connections 53
- preferences. *See* System Preferences
- problems
 - computer freezes 48
 - computer won't turn on 46, 49
 - display goes black 50
 - Internet connection 51
 - pointer won't move 46
 - PPPoE connections 53
 - trouble ejecting a disc 50
 - trouble using AirPort 54
 - See also* troubleshooting
- putting your MacBook Pro to sleep 15

Q

- question mark, flashing 48

R

- RAM, installing 35
- reinstalling software 56
- removing the battery 35
- replacing the battery 42
- resetting your password 50

- Rewind key 23
- right click 26
- rotating objects using trackpad 28

S

- safety
 - general safety instructions 62
 - power adapter 63
- scrolling trackpad feature 19
- scrolling with two fingers 27
- SDRAM specifications 34
- secondary click 26
- security slot 25
- serial number, finding 59
- service and support 58
- Setup Assistant 51
- shutting down 16
- sleep
 - indicator light 19
 - mode 15
- slot-loading optical drive 19
- software
 - reinstalling 56
 - updating 55
- Software Update 55
- speakers 21
- specifications 32
- Startup Disk preferences 48
- stopping

- an application 46
- your computer 16
- storing your computer 66
- SuperDrive
 - about 19
 - supported disc sizes 66
- support 58
- swiping to move quickly through documents 28
- System Preferences
 - customizing the desktop 15
 - Energy Saver 15
 - Software Update 55
 - Startup Disk 48
- System Profiler 57

T

- three-finger swiping 28
- trackpad 19
 - scrolling 19
 - shortcuts 26
 - zooming 19
- troubleshooting
 - AirPort 54
 - AppleCare 58
 - computer freezes 48
 - computer won't respond 46
 - computer won't turn on 49
 - display goes black 50
 - ejecting a disc 50

- hardware problems 51
- Internet connection 51
- pointer won't move 46
- service and support 57
- using Mac Help 57
- See also* problems
- turning on your
 - MacBook Pro 12
- two-finger pinching 27
- two-finger rotating 28
- typing position 67

U

- updating software 55
- USB
 - connections 32
 - ports 25

V

- video camera indicator light 21
- volume controls 23

W

- waking your MacBook Pro 15

Z

- zooming using the
 - trackpad 19, 27

 Apple Inc.

© 2008 Apple Inc. All rights reserved.

Under the copyright laws, this manual may not be copied, in whole or in part, without the written consent of Apple.

Every effort has been made to ensure that the information in this manual is accurate. Apple is not responsible for printing or clerical errors.

Apple

1 Infinite Loop

Cupertino, CA 95014-2084

408-996-1010

www.apple.com

Apple, the Apple logo, AirPort, AirPort Express, AirPort Extreme, Cover Flow, Exposé, FileVault, FireWire, GarageBand, iCal, iChat, iLife, iMovie, iPhoto, iPod, iSight, iTunes, Keynote, Mac, MacBook, Macintosh, Mac OS, MagSafe, Photo Booth, and SuperDrive are trademarks of Apple Inc., registered in the U.S. and other countries.

Finder, the FireWire logo, iPhone, iWeb, Safari, and Spotlight are trademarks of Apple Inc.

AppleCare and Apple Store are service marks of Apple Inc., registered in the U.S. and other countries.

iTunes Store is a service mark of Apple Inc.

ENERGY STAR® is a U.S. registered trademark.

Intel, Intel Core, and Xeon are trademarks of Intel Corp. in the United States and other countries.

The Bluetooth® word mark and logos are owned by the Bluetooth SIG, Inc. and any use of such marks by Apple Inc. is under license.

Other company and product names mentioned herein are trademarks of their respective companies. Mention of third-party products is for informational purposes only and constitutes neither an endorsement nor a recommendation. Apple assumes no responsibility with regard to the performance or use of these products.

Manufactured under license from Dolby Laboratories. "Dolby," "Pro Logic," and the double-D symbol are trademarks of Dolby Laboratories. Confidential Unpublished Works, © 1992–1997 Dolby Laboratories, Inc. All rights reserved.

The product described in this manual incorporates copyright protection technology that is protected by method claims of certain U.S. patents and other intellectual property rights owned by Macrovision Corporation and other rights owners. Use of this copyright protection technology must be authorized by Macrovision Corporation and is intended for home and other limited viewing uses only unless otherwise authorized by Macrovision Corporation. Reverse engineering or disassembly is prohibited.

Apparatus Claims of U.S. Patent Nos. 4,631,603, 4,577,216, 4,819,098 and 4,907,093 licensed for limited viewing uses only.

Simultaneously published in the United States and Canada.