

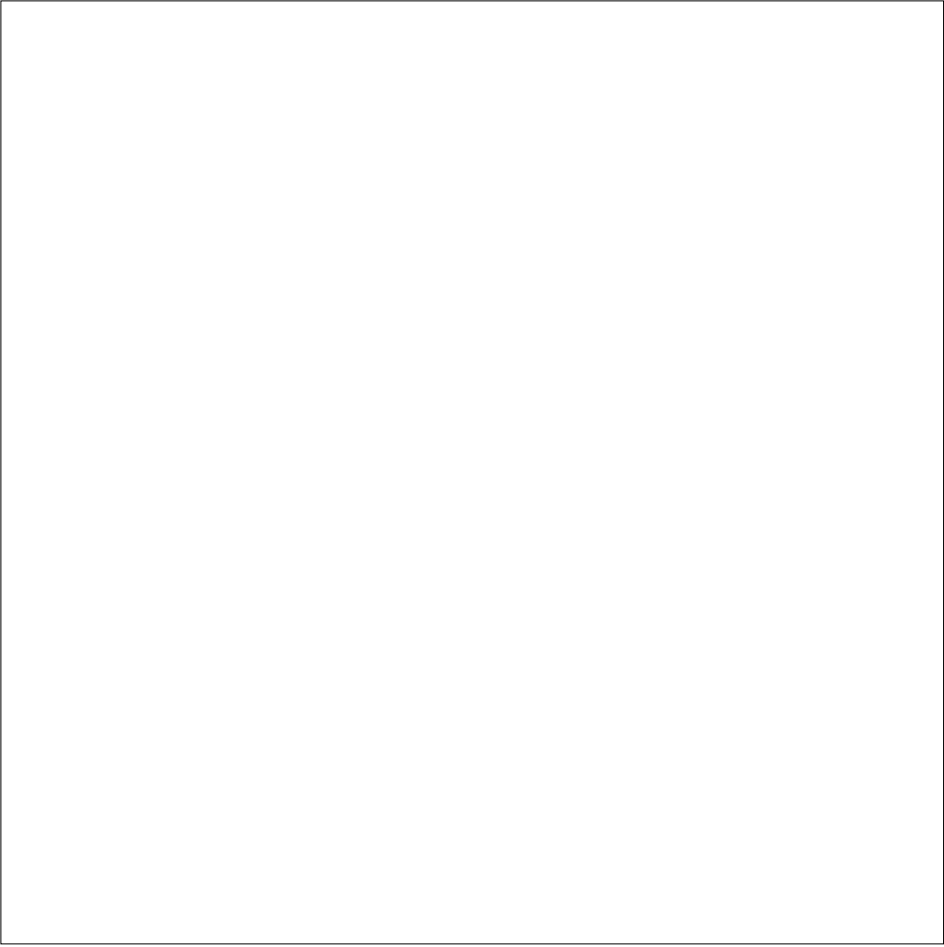

iPod
User's Guide



Contents

5 **Quick Start**

7 What You Need to Get Started

10 Setting Up iPod to Play Music

15 **Using iPod**

15 Using iPod Controls

21 Connecting and Disconnecting iPod

24 Organizing and Transferring Your Music

30 Adjusting iPod Settings

34 Using the Extra Features of Your iPod

41 iPod Accessories

45 Charging the iPod Battery

50 **Tips and Troubleshooting**

55 **Learning More, Service, and Support**

57 **Safety and Cleaning**

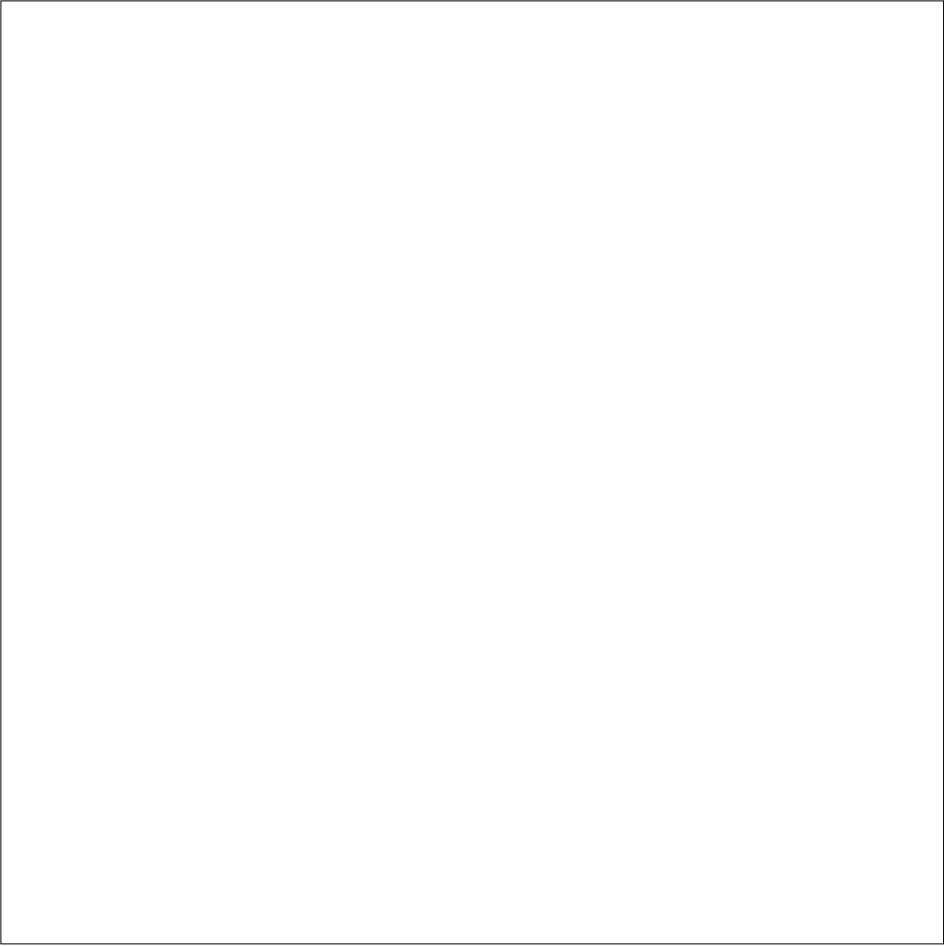

Quick Start

Congratulations on purchasing your iPod. Read this section to get started using iPod quickly.

iPod works with the iTunes music software included on the iPod CD. Use iTunes to import songs from your CD or digital music collection to your computer, or use the iTunes Music Store (available in some countries only) to purchase songs and download them to your computer. Then organize the songs and transfer them to iPod.

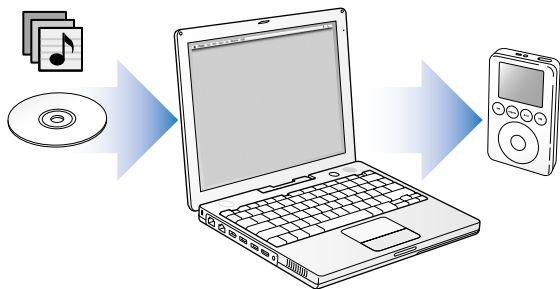

iPod Features

iPod is a music player and much more. With iPod, you can:

- Store thousands of songs from your CD or digital music collection, for listening on the go
- Listen to audiobooks purchased from the iTunes Music Store (you must have an Internet connection)
- Store and synchronize contact, calendar, and to-do list information from your computer
- Store text notes
- Set an alarm
- Record voice memos (using an optional microphone)
- Store digital photos (using an optional photo card reader)
- Play games, and more

To purchase a microphone, photo card reader, and other iPod accessories, go to www.apple.com/store.

Learning to Use iPod

Read this chapter to set up iPod and get started playing music quickly. To learn more about playing music on iPod and using some of its other features, see “Using iPod” on page 15.

What You Need to Get Started

To use iPod with a Macintosh, you must have:

- A Macintosh with built-in FireWire



6-pin FireWire 400 port

- Mac OS X v10.1.5 or later

Some features require Mac OS X v10.2 or later (Mac OS X v10.3.3 or later is recommended).

- iTunes 4.2 or later (iTunes is included on the iPod CD)

To be sure you have the latest version of iTunes, go to www.apple.com/itunes.

- iSync 1.1 and iCal 1.0.1 or later

iSync and iCal are optional for synchronizing contact and calendar information with iPod. You must have Mac OS X v10.2 or later to use iSync and iCal.

To use iPod with a Windows PC, you must have:

- A Windows PC with 500 MHz or higher processor speed
- Windows 2000 with Service Pack 4 or later, or Windows XP Home or Professional
- iTunes 4.2 or later (iTunes is included on the iPod CD)
To be sure you have the latest version of iTunes, go to www.apple.com/itunes.
- iPod software (included on the iPod CD)
- Built-in FireWire or a FireWire card installed, or built-in USB 2.0 or a USB 2.0 card and the optional iPod Dock Connector to USB 2.0 + FireWire Cable



USB port
(USB 2.0 recommended)



6-pin FireWire 400 port
(IEEE 1394)



4-pin FireWire 400 port
(with included adapter)

For more information about compatible FireWire and USB cards and iPod cables, go to www.apple.com/ipod.

Your iPod includes the following components:

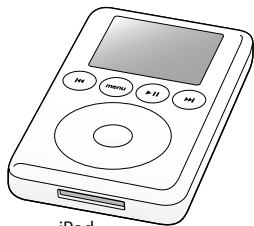

iPod



6-pin-to-4-pin
FireWire adapter



iPod Dock (with some models)

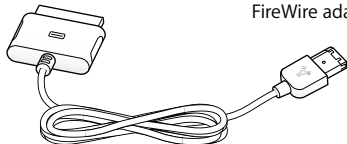

iPod Dock Connector to FireWire Cable

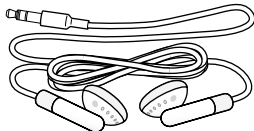

Apple Earphones

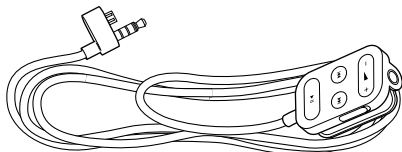

iPod Remote (with some models)



iPod Power Adapter

Note: Some models of iPod also include a carrying case (not pictured).

Setting Up iPod to Play Music

To set up iPod, you charge the battery, install software from the iPod CD, and import songs from your music CD collection to your computer. Then you transfer the songs to iPod and start listening to music.

Step 1: Charge the Battery

Connect iPod to the iPod Power Adapter using the iPod Dock Connector to FireWire Cable. The built-in battery is 80-percent charged in about an hour, and fully charged in about four hours.

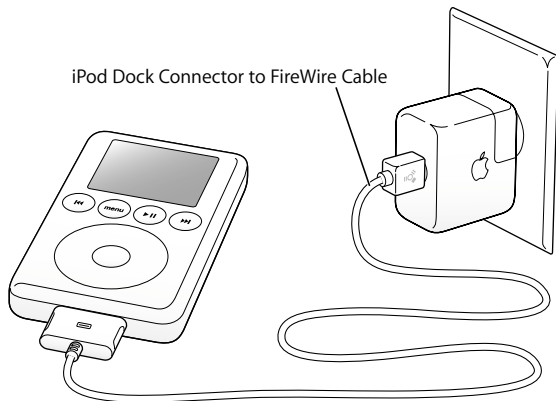

Step 2: Install the Software

Insert the iPod CD into your computer and install iTunes and the iPod software.

Step 3: Import Music to Your Computer

Complete this step if you haven't already transferred music to your computer. You can import music from your audio CDs, or if you have an Internet connection, you can buy music online and download it to your computer using the iTunes Music Store. You can browse hundreds of thousands of songs and listen to a 30-second preview of any song. The iTunes Music Store is available in some countries only.

To import music to your computer from an audio CD:

- 1 Insert a CD into your computer. iTunes opens automatically and the CD is selected in the iTunes Source list.
- 2 Uncheck songs you don't want to transfer, then click Import.
- 3 Repeat for any other CDs with songs you'd like to import.

To buy music online:

- 1 Open iTunes and click Music Store in the Source list.
- 2 Click the Account button and follow the onscreen instructions to set up an account or enter your existing Apple Account or America Online (AOL) account information.

Step 4: Connect iPod and Transfer Music

Connect iPod to your computer using the included iPod Dock Connector to FireWire Cable. You can use the optional iPod Dock (see page 42). Be sure the connectors on both ends of the cable are oriented correctly. They can only be inserted one way.

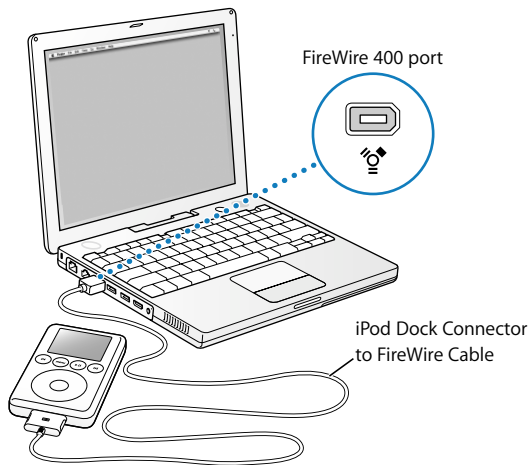

When you connect iPod to your computer, iTunes opens automatically and transfers the songs and playlists in your music library to iPod.

When the transfer is complete, the main menu appears on the iPod screen.

If your Windows PC doesn't have a 6-pin FireWire port:

If your computer doesn't have a 6-pin FireWire (IEEE 1394) port, here are other ways you can connect iPod:

- *If your computer has a 4-pin FireWire port, use the included 6-pin-to-4-pin FireWire adapter.*

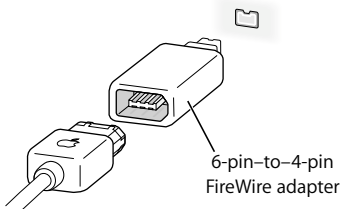

Note: You can't charge iPod through your computer using a 4-pin FireWire port.

- *If your computer has a USB 2.0 port, you can purchase an iPod Dock Connector to USB 2.0 + FireWire Cable from Apple.*
- *If your computer doesn't have a FireWire port or a USB port, you can purchase a FireWire card or USB 2.0 card, and install it.*

Go to www.apple.com/ipod for more information on cables and compatible FireWire and USB cards.

Step 5: Play Music

When the song transfer is complete, disconnect iPod from your computer. Squeeze both sides of the Dock connector to disconnect the cable from iPod.

Then use the Touch Wheel and Select button to browse for a song. Press the Play or Select button and enjoy!

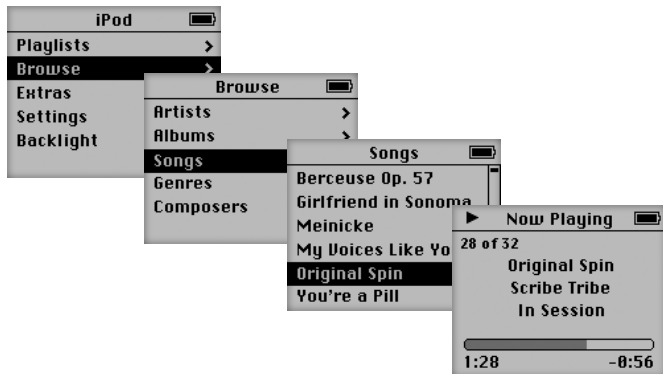

To Learn More

Read the next chapter to learn more about using the Touch Wheel and the other iPod controls, transferring music to and managing music on iPod, using other features of iPod, charging the battery, and using iPod accessories.

Using iPod

Read this section to learn about using iPod controls, transferring music, charging the battery, and using the extra features of your iPod.

Using iPod Controls

Press any button to turn on iPod. The main menu appears.

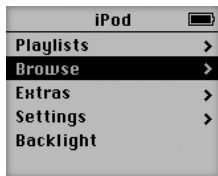

Use the iPod buttons and Touch Wheel to navigate through the onscreen menus, play songs, change settings, and view information. Move your thumb along the Touch Wheel to highlight a menu item. Press the Select button to select the item. Press the Menu button to go back to the previous menu.

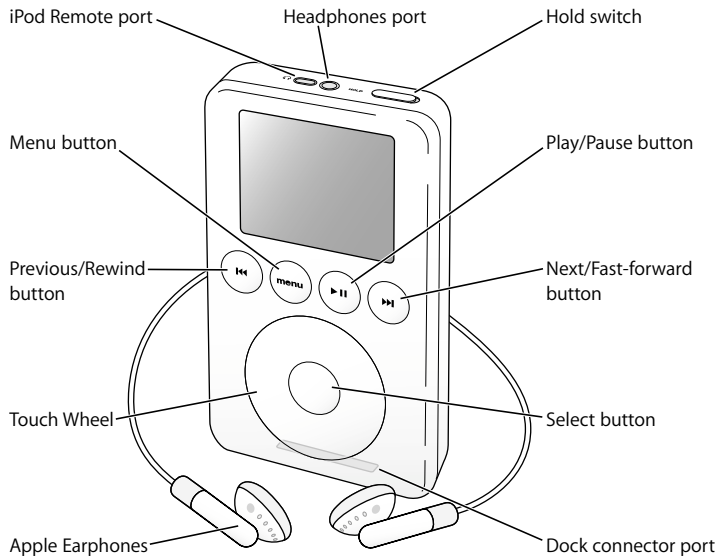

iPod Controls

Reset iPod (For use during troubleshooting)	Toggle the Hold switch (set it to Hold, then turn it off again). Then press Menu and Play/Pause simultaneously for about 5 seconds, until the Apple logo appears.
Turn on iPod	Press any button.
Turn off iPod	Press and hold Play/Pause.
Turn the backlight on or off	Press and hold Menu or select Backlight from the main menu.
Select a menu item	Scroll to the item and press the Select button.
Go back to the previous menu	Press Menu.
Browse for a song	Select Playlists or Browse from the main menu.
Play a song	Highlight the song and press the Select or Play/Pause button.
Play all the songs in a list	Highlight the list title (an album title, or the title of a playlist, for example) and press Play/Pause.
Change the volume	From the Now Playing screen, use the Touch Wheel. You can also use the iPod Remote (included with some models) from any screen.
Pause a song	Press Play/Pause when no song or list is highlighted.

iPod Controls

Disable the iPod buttons (So you don't press them accidentally)	Set the Hold switch to Hold (an orange bar appears).
Skip to any point in a song	From the Now Playing screen, press the Select button. Then scroll to any point in the song.
Skip to the next song	Press Next/Fast-forward.
Start a song over	Press Previous/Rewind.
Play the previous song	Press Previous/Rewind twice.
Fast-forward	Press and hold Next/Fast-forward.
Rewind	Press and hold Previous/Rewind.

Disabling iPod Buttons Using the Hold Switch

If you're carrying iPod in your pocket and you don't want to press the buttons or turn it on accidentally, you can make the buttons inactive.

- Set the Hold switch to Hold.

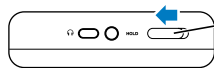

Slide the switch toward the center (so you can see the orange stripe) to disable the controls.

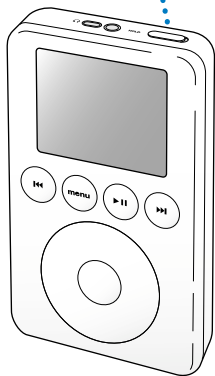

Queueing Up a List of Songs

You can set iPod to play the songs you want in the order you want. When you create a list of songs on your iPod, the songs appear in an On-The-Go playlist.

To create an On-The-Go playlist:

- 1 Highlight a song and press and hold the Select button until the song title flashes.
- 2 Repeat step 1 for other songs you want to add.
- 3 Select Playlists > On-The-Go to view your list of songs.

You can also queue entire lists of songs at once. For example, to queue an album, highlight the album title and press and hold the Select button until the album title flashes.

To play songs in the On-The-Go playlist:

- Select Playlists > On-The-Go and select a song.

To clear the On-The-Go playlist:

- Select Playlists > On-The-Go > Clear Playlist.

To transfer On-The-Go playlists to your computer:

- If iPod is set to transfer songs automatically (see page 27), and you create an On-The-Go playlist, the playlist automatically transfers to iTunes when you connect iPod. You see the new On-The-Go playlist in the iTunes Source list.

Rating Songs

You can assign a rating to a song (from 1 to 5 stars) to indicate how much you like it. You can use song ratings to help you create playlists automatically in iTunes (see “About Smart Playlists” on page 26).

To rate a song:

- 1 Start playing the song.
- 2 From the Now Playing screen, press the Select button twice.
- 3 Use the Touch Wheel to select a rating.

Connecting and Disconnecting iPod

You connect iPod to your computer to transfer and manage music, and, in most cases, to charge the battery.

- If you have a Mac or if you have a Windows PC with a FireWire port, connect iPod using the included FireWire cable.
- If you have a Windows PC with a USB 2.0 port (and no FireWire port), use the optional iPod Dock Connector to USB 2.0 + FireWire Cable (available at www.apple.com/store—see page 48 for an illustration).

To connect iPod to your computer:

- Plug the appropriate cable in to a FireWire or USB 2.0 port on your computer, then connect the other end to iPod. Be sure to orient the connectors on the cable correctly. Each connector can only be inserted one way.
- Or, if you have an iPod Dock (see page 42), connect the appropriate cable to a FireWire or USB 2.0 port on your computer and connect the other end to the Dock. Then put iPod in the Dock.

Note: If you are using a Windows PC with a USB port and the optional iPod Dock Connector to USB 2.0 + FireWire Cable, you can connect the cable's FireWire connector to the iPod Power Adapter to charge the battery, and connect the USB connector to your computer's USB port to transfer files at the same time (see page 48 for an illustration).

Important: If you are using the iPod Dock Connector to USB 2.0 + FireWire Cable and your computer has USB and FireWire ports, don't plug the cable's USB and FireWire connectors in to your computer at the same time.

By default, iPod imports songs automatically when you connect it to your computer. When this automatic transfer is done, you can disconnect iPod.

Disconnecting iPod

If you set iPod to transfer songs manually (see page 28) or enable iPod for use as a hard disk (see page 34), you must eject iPod before disconnecting it.

If it's not OK to disconnect iPod, this screen appears:



Important: Don't disconnect iPod if you see the "Do not disconnect" message. You could damage files on iPod. If you see this message, you must eject iPod before disconnecting it.

To eject iPod:

- Select iPod in the iTunes Source list and click the Eject button.



If you're using a Mac, you can also eject iPod by dragging the iPod icon on the desktop to the Trash.

If you're using a Windows PC, you can eject iPod by clicking the Safely Remove Hardware icon in the Windows system tray and selecting your iPod.

If it's OK to disconnect iPod from your computer, the main menu appears:

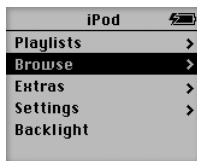

Or, a large battery icon appears:



To disconnect iPod:

- If iPod is in the Dock, simply remove it.
- If iPod is connected to an iPod cable, squeeze both sides of the Dock connector to disconnect the cable from iPod.

Organizing and Transferring Your Music

For instructions for getting started playing music on iPod, see “Setting Up iPod to Play Music” on page 10. Read on for more information about organizing and transferring your music.

About iTunes

iTunes is the software application you use to manage the music on your computer and transfer music to iPod. When you connect iPod to your computer, iTunes opens automatically.



Here are some of the things you can do with iTunes:

- Purchase and download songs from the iTunes Music Store
- Listen to CDs and digital music
- Add music from CDs to your music library, so you don't need to have the CD in the drive to play music
- Organize songs into playlists you create
- Make your own CDs (if your computer has a CD-writable optical drive)
- Listen to Internet radio stations

This booklet explains how to transfer songs to iPod using iTunes and manage songs on iPod. For information about using the other features of iTunes, open iTunes and choose Help > iTunes and Music Store Help.

About the iTunes Music Store

Using iTunes, you can preview, purchase, and download your favorite songs from the iTunes Music Store (available in some countries only). There are hundreds of thousands of songs available for purchase. You can use an Apple Account to sign on to the music store, or if you have an America Online (AOL) account, you can use that.

To browse for and purchase music:

- 1 Open iTunes and click Music Store in the Source list.
- 2 Click the Account button and follow the onscreen instructions to set up an account or enter your existing Apple Account or AOL account information.

You can only have music from five different Music Store accounts on one iPod.

For more information about the iTunes Music Store, open iTunes and choose Help > iTunes and Music Store Help.

Audio File Formats Supported by iPod

- AAC (M4A, M4B, M4P) (up to 320 kbps)
- Apple Lossless (a high-quality compressed format, available using iTunes 4.5 or later)
- MP3 (up to 320 kbps)
- MP3 Variable Bit Rate (VBR)
- WAV
- AA (Audible spoken word)
- AIFF

A song encoded using Apple Lossless format has the same quality as the same song encoded using AIFF or WAV format, but takes up about half the amount of space on iPod. The same song encoded in AAC or MP3 format takes up even less space. When you import music from a CD using iTunes, it is converted to AAC format by default.

If you are using iTunes 4.5 or later on a Windows PC, you can convert nonprotected WMA files to AAC or MP3 format. This can be useful if you have a library of music encoded in WMA format. For more information, open iTunes and choose Help > iTunes and Music Store Help.

iPod does not support MPEG Layer 1 or MPEG Layer 2 audio files.

About Playlists

Using iTunes, you can organize songs into playlists. For example, you can create a playlist with songs to listen to while exercising or with songs for a particular mood.

You can create as many playlists as you like using any of the songs in your computer's music library. Putting a song in a playlist doesn't remove it from the library.

When you connect and update iPod, the playlists are transferred to iPod. To browse through playlists, select Playlists in the iPod main menu.

About Smart Playlists

Using iTunes, you can automatically create customized Smart Playlists from the songs in your library. You can create a Smart Playlist that includes only certain genres of music, songs by certain artists, or songs that match particular criteria. For example, you could create a playlist that's no more than 3 gigabytes (GB) in size and includes only songs you have rated 3 stars or higher (see "Rating Songs" on page 20).

After you create a Smart Playlist, any songs on iPod that meet the Smart Playlist's criteria are automatically added to the Smart Playlist.

Creating Playlists on Your Computer

To create a playlist:

- In iTunes, click the Add (+) button and type a name for the playlist, then drag songs from the library or another playlist to the new playlist.

To create a Smart Playlist:

- In iTunes, choose File > New Smart Playlist and choose the criteria for your playlist. Any songs from your library that match the criteria you choose are automatically added to the playlist.

Transferring Songs and Playlists to iPod Automatically

By default, iPod updates automatically when you connect it to your computer. iTunes updates the iPod music library to match the songs and playlists in your computer's music library, transferring new songs to iPod and deleting songs from iPod that aren't in your music library.

You can set iPod to transfer only certain songs in the iTunes library Source list. This is useful if you have more music on your computer than will fit on your iPod.

To update iPod with only certain songs:

- 1 In iTunes, check the boxes next to songs you want to transfer (by default, all songs are checked).
- 2 Select iPod in the iTunes Source list and click the Options button.



Options button

- 3 Select “Only update checked songs.”

To set iPod to update only selected playlists:

- 1 In iTunes, select iPod in the Source list and click the Options button.
- 2 Select “Automatically update selected playlists only.”

Transferring Songs and Playlists to iPod Manually

You can set iPod to transfer songs manually, so you can transfer individual songs and playlists.

When iPod is set to transfer songs manually, it doesn’t synchronize automatically when you connect it to your computer.

To set iPod to transfer songs manually:

- 1 In iTunes, select iPod in the Source list and click the Options button.



Options button

- 2 Select “Manually manage songs and playlists.”

To transfer a song or playlist to iPod manually:

- In iTunes, drag a song or playlist to iPod in the Source list.

Deleting Songs and Playlists From iPod Manually

If you have set iPod to transfer songs manually (see above), you can delete songs and playlists from iPod individually. Songs deleted from iPod manually are not deleted from the iTunes library.

To delete a song or playlist from iPod:

- 1 Select iPod in the iTunes Source list.
- 2 Select a song or playlist and press the Delete key on the keyboard.

If you delete a playlist, the songs in the playlist remain on iPod.

Modifying Playlists on iPod Manually

If you have set iPod to transfer songs manually (see above), you can create new playlists on iPod, and add songs to or delete songs from playlists already on iPod.

To create a new playlist on iPod:

- 1 Select iPod in the iTunes Source list and click the Add (+) button.
- 2 Drag songs to the new playlist.

To modify a playlist on iPod:

- Drag a song to a playlist on iPod to add the song. Select a song in a playlist and press the Delete key on your keyboard to delete the song.

Listening to Spoken Word Audio

You can purchase and download spoken word audiobooks from the iTunes Music Store (available in some countries only) and listen to them on your iPod.

You can use iTunes to transfer audiobooks to your iPod the same way you transfer songs.

If you stop listening to an audiobook on iPod and go back to it later, the audiobook begins playing from where you left off.

Seeing How Many Songs Are on iPod

To see how many songs are stored on iPod, how much disk space is left, and other information, select Settings > About in the iPod main menu.

Adjusting iPod Settings

You can change settings directly on iPod in the Settings menu.

Setting iPod to Shuffle or Repeat Songs

You can set iPod to repeat a song over and over, or to repeat a sequence of songs. You can also set it to shuffle (play songs or albums in random order).

iPod repeats or shuffles songs within the list (album or playlist, for example) from which the first song was selected.

To set iPod to repeat songs:

- Select Settings from the iPod main menu.
 - *To repeat all songs in the list*, set Repeat to All.
 - *To repeat one song over and over*, set Repeat to One.

To set iPod to shuffle songs or albums:

- 1 Select Settings from the iPod main menu.
- 2 Set Shuffle to Songs or to Albums.

When you set iPod to shuffle albums, it plays all the songs on an album in order, then randomly selects another album and plays through it in order.

When set to shuffle, iPod won't repeat a song or album until it has played through the entire list from which the first song or album was selected.

Setting Songs to Play at the Same Relative Volume Level

iTunes can automatically adjust the volume of songs, so they play at the same relative volume level. You can set iPod to use the iTunes volume settings.

To set iTunes to adjust all songs to play at the same relative sound level:

- 1 In iTunes, choose iTunes > Preferences if you are using a Mac, or choose Edit > Preferences if you are using a Windows PC.
- 2 Click Effects and select Sound Check.

To set iPod to use the iTunes volume settings:

- Select Settings > Sound Check.

If you have not activated Sound Check in iTunes, setting it on iPod has no effect.

Using the iPod Equalizer

You can use equalizer presets to change iPod sound to suit a particular music genre or style. For example, to make rock music sound better, set the equalizer to Rock.

- Select Settings > EQ and select an equalizer preset.

Setting the Backlight Timer

You can set the backlight to turn on for a certain amount of time when you press a button or use the Touch Wheel.

- Select Settings > Backlight Timer and select the time you want.

Even if you don't set the backlight timer, you can turn on the backlight at any time by pressing and holding the Menu button on iPod or selecting Backlight from the main menu. After a few seconds, the backlight turns off.

Setting the Screen Contrast

- 1 Select Settings > Contrast.
- 2 Use the Touch Wheel to adjust the contrast.

If you accidentally set the screen contrast too light or too dark, you can reset it to the default by pressing and holding the Menu button for about 4 seconds.

Adding or Removing Items From the Main Menu

You can add often-used items to the iPod main menu. For example, you can add a "Songs" item to the main menu, so you don't have to select Browse before you select Songs.

To add or remove items from the main menu:

- Select Settings > Main Menu.

Setting and Viewing Date and Time

To set the date and time:

- Select Settings > Date & Time.

To view the date and time:

- Select Extras > Clock.

To set iPod to display the time in the title bar:

- Select Settings > Date & Time.

If you set iPod to display the time in the title bar, you can see the time from any iPod menu screen.

Setting the Language

iPod can be set to use different languages.

- Select Settings > Language and select a language.

If you accidentally set iPod to use a language you don't understand, you can reset the language.

- 1 Push Menu repeatedly until the main menu appears.
- 2 Select the fourth menu item (Settings).
- 3 Select the last menu item (Reset All Settings).
- 4 Select the second menu item (Reset) and select a language.

Other iPod settings, such as song repeat, are also reset.

Note: If you have added or removed items from your main menu (see page 32), the Settings menu may be in a different place.

Using the Extra Features of Your iPod

Using iPod as an External Hard Disk

You can use iPod as a hard disk, to store and transfer data files.

To enable iPod as a hard disk:

- 1 In iTunes, select iPod in the Source list and click the Options button.



Options button

- 2 Select “Enable FireWire disk use.”

When you use iPod as a hard disk, the iPod disk icon appears on the desktop on the Mac, or as the next available drive letter in Windows Explorer on a Windows PC.

Note: Selecting “Manually manage songs and playlists” in the Options window also enables iPod to be used as a hard disk.

Note: To transfer music files to iPod, you must use iTunes. Songs transferred via iTunes do not appear on iPod in the Macintosh Finder or Windows Explorer. Likewise, if you copy music files to iPod in the Macintosh Finder or Windows Explorer, you won’t be able to play them on iPod.

Preventing iTunes From Opening Automatically

If you use iPod primarily as a hard disk, you may want to disable iTunes from opening automatically when you connect iPod to your computer.

To prevent iTunes from opening automatically when you connect iPod to your computer:

- 1 In iTunes, select iPod in the Source list.
- 2 Click the Options button and deselect “Open iTunes when attached.”



Options button

Setting the Sleep Timer

You can set iPod to turn off automatically after a specific period of time.

- Select Extras > Clock > Sleep Timer and select the time you want.

When you set the sleep timer, a clock icon and the number of minutes left until iPod turns off appear in the Now Playing screen on iPod.

Setting the Alarm

You can use iPod as an alarm clock.

To set an alarm:

- 1 Select Extras > Clock > Alarm Clock.
- 2 Set Alarm to On.

3 Select a sound.

If you select Beep, the alarm will be audible through the internal speaker. If you select a playlist, you'll need to connect iPod to speakers or headphones to hear the alarm.

Importing Addresses, Phone Numbers, Calendar Events, and To-Do Lists

Your iPod can store contacts, calendar events, and to-do lists, for viewing on the go. If you are using a Mac and iSync, it's as easy as clicking a button.

To import all information using a Mac and iSync:

- 1 Connect iPod to your computer.
- 2 Open iSync and choose Devices > Add Device. You only need to do this step the first time you use iSync with your iPod.
- 3 Select iPod and click Sync Now.

The next time you want to sync iPod, you can simply open iSync and click Sync Now. You can also choose to have iPod sync automatically when you connect it. iSync imports information from iCal and Mac OS X Address Book.

Note: iSync transfers information from your computer to iPod. You can't use iSync to transfer information from your iPod to your computer.

If you are using Windows, or you don't want to import using iSync, you can transfer information to iPod manually. iPod must be enabled as a hard disk (see "Using iPod as an External Hard Disk" on page 34).

To import contact information manually:

- 1 Connect iPod and open your favorite email or contacts application. Importing contacts works with Palm Desktop, Microsoft Outlook, Microsoft Entourage, and Eudora, among others.
- 2 Drag contacts from the application's address book to the iPod Contacts folder.

To import appointments and other calendar events manually:

- 1 Export calendar events from any calendar application that uses the standard iCalendar format (filenames end in .ics) or vCal format (filenames end in .vcs).
- 2 Drag the files to the Calendars folder on iPod.

Note: You can only view to-do lists on iPod using iSync and iCal.

To view contacts on iPod:

- Select Extras > Contacts.

To view calendar events:

- Select Extras > Calendar.

To view to-do lists:

- Select Extras > Calendar > To Do.

Storing and Reading Notes and Other Information

You can store and read text notes on iPod. iPod must be enabled as a hard disk (see page 34).

- 1 Save a document in any word-processing application as a text (.txt) file.
- 2 Place the file in the Notes folder on iPod.

To view notes:

- Select Extras > Notes.

Recording Voice Memos

You can record voice memos using an optional iPod-compatible microphone (available for purchase at www.apple.com/store). You can store recordings on your iPod and transfer them to your computer.

To record a voice memo:

- 1 Connect a microphone to the Headphones port on your iPod and select Record to begin recording.
- 2 Hold the microphone a few inches from your mouth and speak. To pause recording, select Pause.
- 3 When you're finished recording, select Stop and Save. Your recording is saved and listed by date and time recorded.

To play a recording:

- Select Extras > Voice Memos and select the recording. Recordings are listed by date and time recorded.

Recordings are saved in a Recordings folder on iPod in the WAV file format.

Note: The Voice Memos menu item doesn't appear until you connect a microphone.

To transfer voice memos to your computer:

If iPod is set to transfer songs automatically (see page 27) and you record voice memos, the voice memos are automatically transferred to a playlist in iTunes when you connect iPod. You see the new Voice Memos playlist in the iTunes Source list.

Storing Digital Photos

Using an optional iPod-compatible photo card reader (available for purchase at www.apple.com/store) and a standard digital camera and photo card, you can store photos on iPod, then delete them from the photo card and take more pictures. Then later you can transfer the photos from iPod to your computer using a standard digital photo application (such as iPhoto, on a Macintosh).

To store photos on iPod:

- 1 Insert a photo card into the photo card reader and connect the photo card reader to the Dock connector port on iPod.
- 2 Select Import.

Photos are listed on iPod by roll number.

To view information about photos stored on iPod:

- Select Extras > Photo Import and select the roll number.

The type of media, number of photos, and size of the roll are displayed. You can't view the photos on iPod.

Note: The Photo Import menu item doesn't appear unless you connect a photo card reader.

To erase photos from a photo card:

- 1 Import photos from the card (see above).
- 2 Select Erase Card. All photos are deleted from the photo card.

To transfer photos to your computer:

- Connect iPod to your computer and open the application you use to transfer photos from your digital camera. See the documentation that came with the application for more information.

If you are using a Macintosh, you can use iPhoto or Image Capture to transfer photos.

Note: Photos are stored in a DCIM (digital camera images) folder on iPod. You can also transfer images to your computer by opening this folder and dragging the image files to the desktop. iPod must be enabled for use as a hard disk.

For more information about using an iPod-compatible photo card reader, see the instructions that came with the reader.

Playing Games

iPod has a number of games.

To play a game:

- Select Extras > Games and select a game.

iPod Accessories

iPod comes with some accessories, and many other accessories are available at www.apple.com/store.

iPod Remote (Included With Some Models)

To use the iPod Remote, connect it to the iPod Remote port, then connect the Apple Earphones (or another set of headphones) to the remote. Use the buttons on the remote just as you would use the iPod buttons.

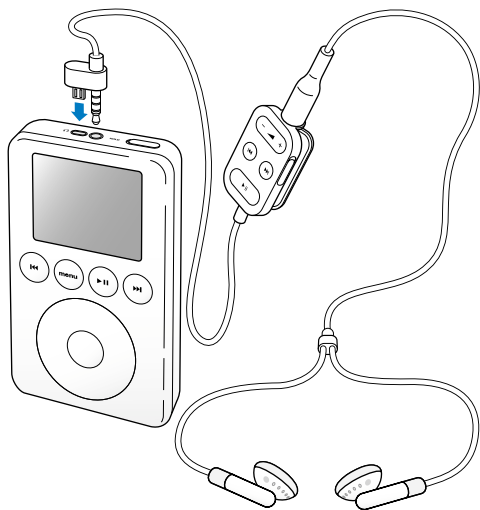

Use the remote's Hold switch to disable the remote's buttons. The iPod Hold switch and the iPod Remote Hold switch do not affect one another.

iPod Dock (Included With Some Models)

The iPod Dock holds iPod upright as it charges or transfers music. Connect the Dock to your computer using the same cable you use with iPod, or connect it to a power outlet using the FireWire cable and power adapter. Then put iPod in the Dock.

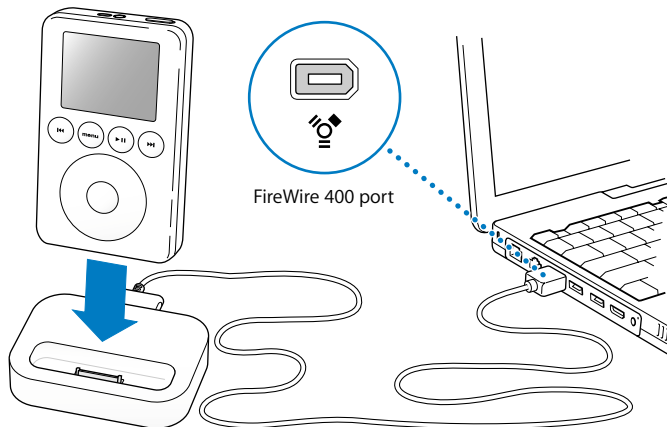

Note: Be sure the connectors on the cable are oriented correctly. Each connector can only be inserted one way. Your computer must be on and not in sleep mode (some models of Macintosh can charge iPod while in sleep mode).

Using the iPod Dock, you can play music from iPod over external powered speakers or a home stereo. You need an audio cable with a standard 3.5 millimeter stereo miniplug (many external speakers have this type of cable attached).

To play music from iPod using the Dock:

- 1 Place iPod in the Dock.
- 2 Connect the speakers or stereo to the Dock Line Out port using an audio cable with a 3.5 millimeter stereo miniplug.

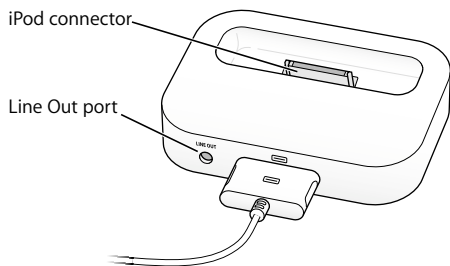

- 3 Use the iPod controls to play a song.

When the Dock is connected to an external audio source, use the volume controls on the external source to change the volume.

Apple Earphones

iPod comes with a pair of high-quality earbud headphones.

To use the earbud headphones:

- Plug them in to the Headphones port, then place the earbud in your ear as shown.



Warning Listening to music at high volume over extended periods of time can damage your hearing.

Available Accessories

To purchase iPod accessories, go to www.apple.com/store.

Available accessories include:

- iPod Dock
- iPod Remote + Earphones
- iPod In-Ear Headphones
- iPod Dock Connector to FireWire Cable
- iPod Dock Connector to USB 2.0 + FireWire Cable
- iPod Power Adapter
- iPod Carrying Case
- World Travel Adapter Kit
- Third-party accessories such as speakers, headsets, microphones, photo card readers, backup batteries, car stereo adapters, power adapters, and more

Charging the iPod Battery

The iPod battery is 80-percent charged in about an hour, and fully charged in about four hours. If you charge iPod while transferring files or playing music, it may take longer.

iPod has an internal, nonremovable battery. If iPod isn't used for a while, the battery may need to be charged.

You can charge the iPod battery in two ways:

- If you have a Mac, you can charge iPod by connecting it to your computer. If you have a Windows PC with a 6-pin FireWire port, in most cases you can charge iPod by connecting it to your computer.
- You can also charge iPod by connecting it to the power adapter and a working electrical outlet.

To charge the battery using your computer:

- Connect iPod to a 6-pin FireWire port on your computer using the included FireWire cable. The computer must be turned on and not in sleep mode (some models of Macintosh can charge iPod while in sleep mode).

If the battery icon in the upper-right corner of the iPod screen shows a lightning bolt, the battery is charging.



If you don't see the lightning bolt, you must charge the battery using the iPod Power Adapter.

To charge the battery using the iPod Power Adapter:

- 1 Connect the AC plug adapter to the power adapter (this may already be assembled).
- 2 Connect the FireWire cable included with iPod (or the FireWire connector on the optional iPod Dock Connector to USB 2.0 + FireWire Cable) to the power adapter, and plug the other end of the cable in to iPod.
- 3 Plug the power adapter in to a working electrical outlet.

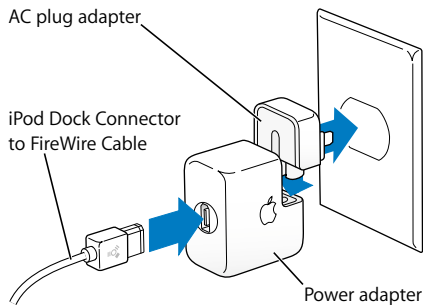

Warning Make sure the power adapter is fully assembled before plugging it in to an electrical outlet.

Note: If you are using a Windows PC with a USB 2.0 port and the optional iPod Dock Connector to USB 2.0 + FireWire Cable (available for purchase at www.apple.com/store), you can connect the cable's FireWire connector to the iPod Power Adapter to charge the battery, and connect the USB connector to your computer's USB port to transfer files at the same time.

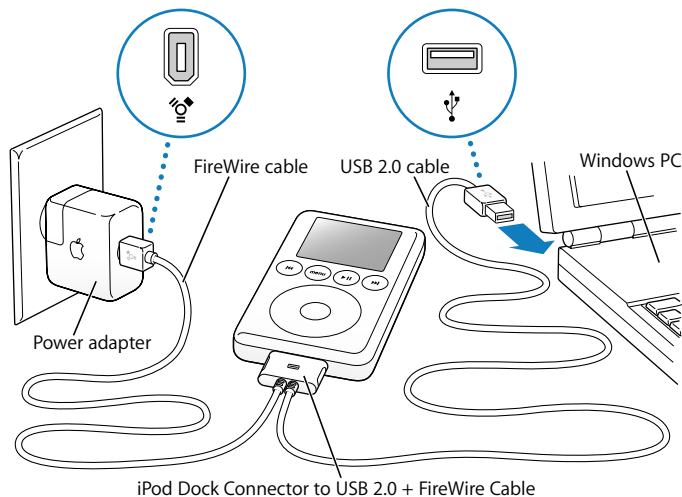

Note: You can't charge iPod using USB.

Battery States

When iPod is not connected to a power source, a battery icon in the top-right corner of the iPod screen shows about how much charge is left.



Battery about
halfway charged

If iPod is connected to a power source, the battery icon animates to show that the battery is charging.



Battery charging

If you connect iPod to a power source and the battery icon does not animate, the battery is fully charged.



Battery fully charged
(if not animated)

You can disconnect and use iPod before it is fully charged.

Note: Rechargeable batteries have a limited number of charge cycles and may eventually need to be replaced. Battery life and number of charge cycles vary by use and settings. For more information, go to www.apple.com/batteries.

Tips and Troubleshooting

Most problems with iPod can be solved quickly by following the advice in this chapter.

Resetting iPod

Most problems with iPod can be solved by resetting it.

To reset iPod:

- 1 Connect iPod to a power outlet using the iPod Power Adapter.
- 2 Toggle the Hold switch on and off (set it to Hold, then turn it off again).
- 3 Press and hold the Play/Pause and Menu buttons for at least 5 seconds, until the Apple logo appears.

If Your iPod Won't Turn On or Respond

- Make sure the Hold switch is off.
- If you're using the iPod Remote, make sure the remote's Hold switch is off.
- If that doesn't work, connect iPod to the iPod Power Adapter and connect the adapter to a working electrical outlet. Your iPod battery may need to be recharged.
- If that doesn't work, your iPod may need to be reset (see above).

- If you're using the iPod Dock Connector to USB 2.0 + FireWire Cable (see page 13) and your computer has USB and FireWire ports, don't plug the cable's USB and FireWire connectors in to your computer at the same time. If you have done this, unplug the cables and reset iPod (see above).
- If that doesn't work, you may need to restore iPod software. See "Software Update and Restore" on page 53.

If You Want to Disconnect iPod, but the Screen Says "Do Not Disconnect"

- If iPod is transferring music, wait for the transfer to complete.
- Select iPod in the iTunes Source list and click the Eject button.
- If iPod disappears from the iTunes Source list, but you still see the "Do Not Disconnect" message on the iPod screen, go ahead and disconnect iPod.
- If iPod doesn't disappear from the iTunes Source list, drag the iPod icon from the desktop to the Trash (if you're using a Mac) or click the Safely Remove Hardware icon in the system tray and select your iPod (if you're using a Windows PC). If you still see the "Do Not Disconnect" message, restart your computer and eject iPod again.

If Your iPod Isn't Playing Music

- Make sure the Hold switch is off.
- If you're using the iPod Remote, make sure the remote's Hold switch is off.
- Make sure the headphones connector is pushed in all the way.
- Make sure the volume is adjusted properly.

- If that doesn't work, push the Play/Pause button. Your iPod may be paused.
- If you're using the iPod Dock, be sure the iPod is seated firmly in the Dock and make sure all cables are connected properly.
- If you are using the Dock Line Out port, make sure your external speakers or stereo are turned on and working properly.

If You Connect iPod to Your Computer and Nothing Happens

- Make sure you have installed the software on the iPod CD.
- Make sure you have the required computer and software. See "What You Need to Get Started" on page 7.
- Your iPod may need to be reset (see page 50).
- Check the cable connections. Unplug the cable at both ends and make sure no foreign objects are in the FireWire or USB ports. Then plug the cable back in securely. Use only Apple iPod cables. Be sure the connectors on the cables are oriented correctly. They can only be inserted one way.
- If you're connecting iPod to a Windows PC using the optional iPod Dock Connector to USB 2.0 + FireWire Cable, be sure you're connecting it to a USB 2.0 port.
- If you're connecting iPod to a Windows PC laptop computer using the optional iPod Dock Connector to USB 2.0 + FireWire Cable, connect the laptop to a power outlet before connecting iPod.
- If that doesn't work, restart your computer.
- If that doesn't work, you may need to restore iPod software. See "Software Update and Restore" on page 53.

If You Connect iPod to a USB Port and It Doesn't Work Correctly

- If you're using a Mac, connect iPod to a FireWire port on your Mac using the FireWire cable that came with iPod.
- If you're using iPod with a USB 1.1 port on your computer, you must use a FireWire port or a USB 2.0 port. USB 1.1 is not supported and is significantly slower than FireWire and USB 2.0. If your Windows PC doesn't have a FireWire port or USB 2.0 port, you can purchase a Windows-certified FireWire card or USB 2.0 card and install it. For more information, go to www.apple.com/ipod.
- If you're connecting iPod to a Windows PC using the optional iPod Dock Connector to USB 2.0 + FireWire Cable, be sure you're connecting it to a USB 2.0 port.
- If you're connecting iPod to a Windows PC laptop computer using the optional iPod Dock Connector to USB 2.0 + FireWire Cable, connect the laptop to a power outlet before connecting iPod.

If Your iPod Remote Isn't Working

- Make sure the remote's Hold switch is off.
- Make sure the remote is plugged firmly in to iPod, and that the headphones are plugged firmly in to the remote.

The iPod Remote is included with some models of iPod, and can be purchased separately at www.apple.com/store.

Software Update and Restore

Apple periodically updates iPod software to improve performance or add features. It is recommended that you update your iPod to use the latest software.

You can choose either to update or to restore the iPod software.

- *If you choose to update*, the software is updated, but your settings and songs are not affected.
- *If you choose to restore*, all data is erased from your iPod, including songs, files, contacts, photos, calendar information, and any other data. All iPod settings are restored to their original state.

To update or restore iPod with the latest software:

- 1 Go to www.apple.com/support/ipod and download the iPod Updater application.
- 2 Double-click the software install file and follow the onscreen instructions to install the iPod Updater application.
- 3 Connect iPod to your computer and open iTunes. The iPod Updater application opens.

If you're using a Windows PC and the iPod Updater application doesn't open automatically, you can find the updater by choosing Start > All Programs > iPod.

- 4 Follow the onscreen instructions to update or restore iPod software.

If you use the iPod Updater application and it doesn't see that iPod is connected to your computer, reset iPod (see page 50).

If you want to restore iPod software and you don't have an Internet connection, you can use the iPod Updater application that was installed on your computer when you installed the software from the iPod CD.

To restore iPod software without downloading the latest version:

- *If you have a Mac*, you can find the updater in Applications/Utilities.
- *If you have a Windows PC*, you can find the updater by choosing Start > All Programs > iPod.

Learning More, Service, and Support

There is more information about using iPod on the web and in onscreen help.

Online Resources

For the latest information on iPod, go to www.apple.com/ipod.

For iPod service and support information, a variety of forums with product-specific information and feedback, and the latest Apple software downloads, go to www.apple.com/support/ipod.

To register iPod (if you didn't do it when you installed software from the iPod CD), go to www.apple.com/register.

For an online iTunes tutorial (available in some areas only), go to www.apple.com/support/itunes.

Onscreen Help

- To learn more about using iTunes, open iTunes and choose Help > iTunes and Music Store Help.
- To learn more about using iSync (on Mac OS X), open iSync and choose Help > iSync Help.
- To learn more about using iCal (on Mac OS X), open iCal and choose Help > iCal Help.

iPod User's Guide

This booklet is also included as a file on the iPod CD.

Obtaining Warranty Service

If the product appears to be damaged or does not function properly, please follow the advice in this booklet, the onscreen help, and the online resources.

If the unit still does not function, go to www.apple.com/support for instructions on how to obtain warranty service.

Finding the Serial Number of Your iPod

The serial number is printed on the back of your iPod. You can also find it by selecting Settings > About.

Safety and Cleaning

Read on to learn about using iPod safely and cleaning iPod.

Important Safety Instructions

When setting up and using your iPod, remember the following:

- Read all the installation instructions carefully before you plug your iPod Power Adapter in to a power outlet.
- Keep these instructions handy for reference by you and others.
- Follow all instructions and warnings dealing with your iPod.

Warning Electrical equipment may be hazardous if misused. Operation of this product, or similar products, must always be supervised by an adult. Do not allow children access to the interior of any electrical product and do not permit them to handle any cables.

Avoid Hearing Damage

Warning Permanent hearing loss may occur if earbuds or headphones are used at high volume. You can adapt over time to a higher volume of sound, which may sound normal but can be damaging to your hearing. Set your iPod volume to a safe level before that happens. If you experience ringing in your ears, reduce the volume or discontinue use of your iPod.

Do Not Use While Driving

Important: Use of headphones while operating a vehicle is not recommended and is illegal in some areas. Be careful and attentive while driving. Stop listening to your iPod if you find it disruptive or distracting while operating any type of vehicle or performing any other activity that requires your full attention.

Connectors and Ports

Never force a connector into a port. If the connector and port do not join with reasonable ease, they probably don't match. Make sure that the connector matches the port and that you have positioned the connector correctly in relation to the port.

Battery

Do not attempt to remove the iPod battery. iPod must be disposed of according to local environmental regulations.

Using the Power Adapter

- Use only the power adapter that came with your iPod. Adapters for other electronic devices may look similar, but they may damage your iPod.
- The only way to shut off power to your power adapter completely is to disconnect it from the power source.
- Always leave space around your power adapter. Do not use this equipment in a location where airflow around the power adapter is confined, such as a bookcase.
- When connecting or disconnecting your power adapter, always hold the power adapter by its sides. Keep fingers away from the metal part of the plug.
- Before connecting the FireWire cable to the power adapter, make sure there are no foreign objects inside the power adapter's FireWire port.
- The power adapter for your iPod is a high-voltage component and should not be opened for any reason, even when the iPod is off. If the power adapter needs service, see "Learning More, Service, and Support" on page 55.
- Never force a connector into the power adapter FireWire port. If the connector and port do not join with reasonable ease, they probably don't match. Make sure that the connector matches the port and that you have positioned the connector correctly in relation to the port.

About Operating and Storage Temperatures

- Operate your iPod in a place where the temperature is always between 0° and 35° C (32° to 95° F).
- Store your iPod in a place where the temperature is always between –20° and 45° C (–4° to 113° F). Don't leave iPod in your car, since temperatures in parked cars can exceed this range.
- iPod play time may temporarily shorten in low-temperature conditions.
- When you're using your iPod or charging the battery, it is normal for the bottom of the case to get warm. The bottom of the iPod case functions as a cooling surface that transfers heat from inside the unit to the cooler air outside.

Avoid Wet Locations

Warning To reduce the chance of shock or injury, do not use your iPod in or near water or wet locations.

- Keep your iPod and power adapter away from sources of liquids, such as drinks, washbasins, bathtubs, shower stalls, and so on.
- Protect your iPod and the power adapter from direct sunlight and rain or other moisture.
- Take care not to spill any food or liquid on iPod or its power adapter. If you do, unplug iPod before cleaning up the spill.

In case of a spill, you may have to send your equipment to Apple for service. See “Learning More, Service, and Support” on page 55.

Do Not Make Repairs Yourself

Warning Do not attempt to open your iPod or power adapter, disassemble it, or remove the battery. You run the risk of electric shock and voiding the limited warranty. No user-serviceable parts are inside.

For service, see “Learning More, Service, and Support” on page 55.

Cleaning

Follow these general rules when cleaning the outside of your iPod and its components:

- Make sure your iPod is unplugged.
- Use a damp, soft, lint-free cloth. Avoid getting moisture in openings.
- Don't use aerosol sprays, solvents, alcohol, or abrasives.

About Handling

Your iPod may be damaged by improper storage or handling. Be careful not to drop your iPod when playing or transporting the device.

Communications Regulation Information

FCC Compliance Statement

This device complies with part 15 of the FCC rules. Operation is subject to the following two conditions: (1) This device may not cause harmful interference, and (2) this device must accept any interference received, including interference that may cause undesired operation. See instructions if interference to radio or television reception is suspected.

Radio and Television Interference

This computer equipment generates, uses, and can radiate radio-frequency energy. If it is not installed and used properly—that is, in strict accordance with Apple's instructions—it may cause interference with radio and television reception.

This equipment has been tested and found to comply with the limits for a Class B digital device in accordance with the specifications in Part 15 of FCC rules. These specifications are designed to provide reasonable protection against such interference in a residential installation. However, there is no guarantee that interference will not occur in a particular installation.

You can determine whether your computer system is causing interference by turning it off. If the interference stops, it was probably caused by the computer or one of the peripheral devices.

If your computer system does cause interference to radio or television reception, try to correct the interference by using one or more of the following measures:

- Turn the television or radio antenna until the interference stops.
- Move the computer to one side or the other of the television or radio.
- Move the computer farther away from the television or radio.
- Plug the computer in to an outlet that is on a different circuit from the television or radio. (That is, make certain the computer and the television or radio are on circuits controlled by different circuit breakers or fuses.)

If necessary, consult an Apple-authorized service provider or Apple. See the service and support information that came with your Apple product. Or, consult an experienced radio/television technician for additional suggestions.

Important: Changes or modifications to this product not authorized by Apple Computer, Inc. could void the EMC compliance and negate your authority to operate the product.

This product was tested for EMC compliance under conditions that included the use of Apple peripheral devices and Apple shielded cables and connectors between system components. It is important that you use Apple peripheral devices and shielded cables and connectors between system components to reduce the possibility of causing interference to radios, television sets, and other electronic devices. You can obtain Apple peripheral devices and the proper shielded cables and connectors through an Apple Authorized Reseller. For non-Apple peripheral devices, contact the manufacturer or dealer for assistance. Responsible party (contact for FCC matters only): Apple Computer, Inc. Product Compliance, 1 Infinite Loop M/S 26-A, Cupertino, CA 95014-2084, 408-974-2000.

Industry Canada Statement

This Class B device meets all requirements of the Canadian interference-causing equipment regulations.

Cet appareil numérique de la classe B respecte toutes les exigences du Règlement sur le matériel brouilleur du Canada.

VCCI Class B Statement

情報処理装置等電波障害自主規制について

この装置は、情報処理装置等電波障害自主規制協議会 (VCCI) の基準に基づくクラス B 情報技術装置です。この装置は家庭環境で使用されることを目的としていますが、この装置がラジオやテレビジョン受信機に近接して使用されると、受信障害を引き起こすことがあります。

取扱説明書に従って正しい取扱をしてください。

European Community

Complies with European Directives 72/23/EEC and 89/336/EEC.

Apple and the Environment

At Apple, we recognize our responsibility to minimize the environmental impacts of our operations and products. For more information, go to www.apple.com/about/environment.

© 2004 Apple Computer, Inc. All rights reserved.

Apple, the Apple logo, Apple Store, FireWire, iCal, iPod, iTunes, Mac, Macintosh, and Mac OS are trademarks of Apple Computer, Inc., registered in the U.S. and other countries.

Finder, the FireWire logo, and iPhoto are trademarks of Apple Computer, Inc.

www.apple.com/ipod
www.apple.com/support/ipod

034-2595-A
Printed in XXXX