

DIGITAL CAMERA XQ1

Owner's Manual

Thank you for your purchase of this product. This manual describes how to use your FUJIFILM digital camera and the supplied software. Be sure that you have read and understood its contents and the warnings in "For Your Safety" (📖 ii) before using the camera.

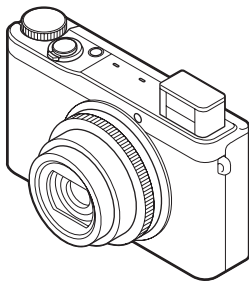

For information on related products, visit our website at http://www.fujifilm.com/products/digital_cameras/index.html

Before You Begin

First Steps

Basic Photography and Playback

More on Photography

More on Playback

Wireless Networks

Movies

Connections

Menus

Technical Notes

Troubleshooting

Appendix



For Your Safety

Be sure to read these notes before use

Safety Notes

- Make sure that you use your camera correctly. Read these safety notes and your *Owner's Manual* carefully before use.
- After reading these safety notes, store them in a safe place.

About the Icons

The icons shown below are used in this document to indicate the severity of the injury or damage that can result if the information indicated by the icon is ignored and the product is used incorrectly as a result.



WARNING

This icon indicates that death or serious injury can result if the information is ignored.



CAUTION

This icon indicates that personal injury or material damage can result if the information is ignored.

The icons shown below are used to indicate the nature of the instructions which are to be observed.



Triangular icons tell you that this information requires attention ("Important").



Circular icons with a diagonal bar tell you that the action indicated is prohibited ("Prohibited").



Filled circles with an exclamation mark indicate an action that must be performed ("Required").

WARNING



Unplug from power source

If a problem arises, turn the camera off, remove the battery, and disconnect and unplug the AC power adapter. Continued use of the camera when it is emitting smoke, is emitting any unusual odor, or is in any other abnormal state can cause a fire or electric shock. Contact your FUJIFILM dealer.



Avoid exposure to water

Do not allow water or foreign objects to enter the camera. If water or foreign objects get inside the camera, turn the camera off, remove the battery, and disconnect and unplug the AC power adapter. Continued use of the camera can cause a fire or electric shock. Contact your FUJIFILM dealer.

WARNING



Do not use in the bathroom or shower

Do not use the camera in the bathroom or shower. This can cause a fire or electric shock.



Do not disassemble

Never attempt to change or take apart the camera (never open the case). Failure to observe this precaution can cause fire or electric shock.



Do not touch internal parts

Should the case break open as the result of a fall or other accident, do not touch the exposed parts. Failure to observe this precaution could result in electric shock or in injury from touching the damaged parts. Remove the battery immediately, taking care to avoid injury or electric shock, and take the product to the point of purchase for consultation.



Do not change, heat or unduly twist or pull the connection cord and do not place heavy objects on the connection cord. These actions could damage the cord and cause a fire or electric shock. If the cord is damaged, contact your FUJIFILM dealer.



Do not place the camera on an unstable surface. This can cause the camera to fall or tip over and cause injury.



Never attempt to take pictures while in motion. Do not use the camera while you are walking or driving a vehicle. This can result in you falling down or being involved in a traffic accident.



Do not touch any metal parts of the camera during a thunderstorm. This can cause an electric shock due to induced current from the lightning discharge.



Do not use the battery except as specified. Load the battery as shown by the indicator.



Do not heat, change or take apart the battery. Do not drop or subject the battery to impacts. Do not store the battery with metallic products. Any of these actions can cause the battery to burst or leak and cause fire or injury as a result.



Use only the battery or AC power adapters specified for use with this camera. Do not use voltages other than the power supply voltage shown. The use of other power sources can cause a fire.



If the battery leaks and fluid gets in contact with your eyes, skin or clothing, flush the affected area with clean water and seek medical attention or call an emergency number right away.

 **WARNING**

Do not use the charger to charge batteries other than those specified here. The supplied battery charger is for use only with the type of battery supplied with the camera. Using the charger to charge conventional batteries or other types of rechargeable batteries can cause the battery to leak fluid, overheat or burst.



Danger of explosion if battery is incorrectly replaced. Replace only with the same.



Do not use in the presence of flammable objects, explosive gases, or dust.



When carrying the battery, install it in a digital camera or keep it in the hard case. When storing the battery, keep it in the hard case. When discarding, cover the battery terminals with insulation tape. Contact with other metallic objects or batteries could cause the battery to ignite or burst.



Keep memory cards out of the reach of small children. Because memory cards are small, they can be swallowed by children. Be sure to store memory cards out of the reach of small children. If a child swallows a memory card, seek medical attention or call an emergency number.



Turn the camera off in crowds. The camera emits radio-frequency radiation that may interfere with pacemakers.



Turn the camera off in the vicinity of automatic doors, public address systems, and other automatically controlled devices. The camera emits radio-frequency radiation that may cause these devices to malfunction.



Keep the camera at least 22 cm (0.7 ft.) away from people wearing pacemakers. The camera emits radio-frequency radiation that may interfere with pacemakers.

 **CAUTION**

Do not use this camera in locations affected by oil fumes, steam, humidity or dust. This can cause a fire or electric shock.



Do not leave this camera in places subject to extremely high temperatures. Do not leave the camera in locations such as a sealed vehicle or in direct sunlight. This can cause a fire.



Keep out of the reach of small children. This product could cause injury in the hands of a child.

 **CAUTION**

Do not place heavy objects on the camera. This can cause the heavy object to tip over or fall and cause injury.



Do not move the camera while the AC power adapter is still connected. Do not pull on the connection cord to disconnect the AC power adapter. This can damage the power cord or cables and cause a fire or electric shock.



Do not use the AC power adapter when the plug is damaged or the plug socket connection is loose. This could cause a fire or electric shock.



Do not cover or wrap the camera or the AC power adapter in a cloth or blanket. This can cause heat to build up and distort the casing or cause a fire.



When you are cleaning the camera or you do not plan to use the camera for an extended period, remove the battery and disconnect and unplug the AC power adapter. Failure to do so can cause a fire or electric shock.



Unplugging from power socket

When charging ends, unplug the charger from the power socket. Leaving the charger plugged into the power socket can cause a fire.



Using a flash too close to a person's eyes may temporarily affect the eyesight. Take particular care when photographing infants and young children.



When a memory card is removed, the card could come out of the slot too quickly. Use your finger to hold it and gently release the card. Injury could result to those struck by the ejected card.



Request regular internal testing and cleaning for your camera. Build-up of dust in your camera can cause a fire or electric shock. Contact your FUJIFILM dealer to request internal cleaning every two years. Please note that this service is not free of charge.



Remove your fingers from the flash window before the flash fires. Failure to observe this precaution could result in burns.



Keep the flash window clean and do not use the flash if the window is obstructed. Failure to observe these precautions could cause smoke or discoloration.

The Battery and Power Supply

Note: Check the type of battery used in your camera and read the appropriate sections.

The following describes the proper use of batteries and how to prolong their life. Incorrect use can shorten battery life or cause leakage, overheating, fire, or explosion.

Li-ion Batteries

Read this section if your camera uses a rechargeable Li-ion battery.

The battery is not charged at shipment. Charge the battery before use. Keep the battery in its case when not in use.

Notes on the Battery

The battery gradually loses its charge when not in use. Charge the battery one or two days before use.

Battery life can be extended by turning the camera off when not in use.

Battery capacity decreases at low temperatures; a depleted battery may not function at when cold. Keep a fully charged spare battery in a warm place and exchange as necessary, or keep the battery in your pocket or other warm place and insert it in the camera only when shooting. Do not place the battery in direct contact with hand warmers or other heating devices.

Charging the Battery

Charging times will increase at ambient temperatures below +10°C (+50°F) or above +35°C (+95°F). Do not attempt to charge the battery at temperatures above 40°C (+104°F); at temperatures below 5°C (+41°F), the battery will not charge.

Do not attempt to recharge a fully charged battery. The battery does not however need to be fully discharged before charging.

The battery may be warm to the touch immediately after charging or use. This is normal.

Battery Life

At normal temperatures, the battery can be recharged about 300 times. A noticeable decrease in the length of time the battery will hold a charge indicates that it has reached the end of its service life and should be replaced.

Storage

Performance may be impaired if the battery is left unused for extended periods when fully charged. Run the battery flat before storing it.

If the camera will not be used for an extended period, remove the battery and store it in a dry place with an ambient temperature of from +15°C to +25°C (+59°F to +77°F). Do not store in locations exposed to extremes of temperature.

Cautions: Handling the Battery

- Do not transport or store with metal objects such as necklaces or hairpins.
- Do not expose to flame or heat.
- Do not disassemble or modify.
- Use with designated chargers only.
- Do not drop or subject to strong physical shocks.
- Do not expose to water.
- Keep the terminals clean.
- The battery and camera body may become warm to the touch after extended use. This is normal.

AA Alkaline/Rechargeable Ni-MH Batteries

Read this section if your camera uses AA alkaline or rechargeable AA Ni-MH batteries. Information on compatible battery types may be found elsewhere in the camera manual.

Cautions: Handling the Batteries

- Do not expose to water, flame, or heat, or store in warm or humid conditions.
- Do not transport or store with metal objects such as necklaces or hairpins.
- Do not disassemble or modify the batteries or battery casing.
- Do not subject to strong physical shocks.
- Do not use batteries that are leaking, deformed, or discolored.
- Keep out of reach of infants and small children.
- Insert in the correct orientation.

- Do not mix old and new batteries, batteries with different charge levels, or batteries of different types.
- If the camera will not be used for an extended period, remove the batteries. Note that the camera clock will be reset.
- The batteries may not be used for the touch immediately after use. Turn the camera off and allow the batteries to cool before handling.
- Battery capacity tends to decrease at low temperatures. Keep spare batteries in a pocket or other warm place and exchange as necessary. Cold batteries may recover some of their charge when warmed.
- Fingerprints and other stains on the battery terminals can impair battery performance. Thoroughly clean the terminals with a soft, dry cloth before inserting them in the camera.



If the batteries leak, clean the battery compartment thoroughly before inserting new batteries.



If fluid from the battery comes into contact with skin or clothing, flush the affected area with water. ***If fluid enters your eyes, immediately flush the affected area with water and seek medical attention. Do not rub your eyes. Failure to observe this precaution could result in permanent visual impairment.***

■ Ni-MH Batteries

The capacity of Ni-MH batteries may be temporarily reduced when new, after long periods of disuse, or if they are repeatedly recharged before being fully discharged. This is normal and does not indicate a malfunction. Capacity can be increased by repeatedly discharging the batteries using the discharge option in the camera setup menu and recharging them using a battery charger.

ⓘ **CAUTION:** Do not use the discharge option with alkaline batteries.

The camera draws a small amount of current even when off. Ni-MH batteries that have been left in the camera for an extended period may be drawn down to the point that they no longer hold a charge. Battery performance may also drop if the batteries are run down in a device such as a flashlight. Use the discharge option in the camera setup menu to discharge Ni-MH batteries. Batteries that no longer hold a charge even after repeatedly being discharged and recharged have reached the end of their service life and must be replaced.

Ni-MH batteries can be recharged in a battery charger (sold separately). Batteries may become warm to the touch after charging. Refer to the instructions provided with the charger for more information. Use the charger with compatible batteries only.

Ni-MH batteries gradually lose their charge when not in use.

■ Disposal

CAUTION: Dispose of used batteries in accord with local regulations.

AC Power Adapters (Available Separately)

This section applies to all camera models. Use only FUJIFILM AC power adapters designated for use with this camera. Other adapters could damage the camera.

- The AC power adapter is for indoor use only.
- Be sure the DC plug is securely connected to the camera.
- Turn the camera off before disconnecting the adapter. Disconnect the adapter by the plug, not the cable.
- Do not use with other devices.
- Do not disassemble.
- Do not expose to high heat and humidity.
- Do not subject to strong physical shocks.
- The adapter may hum or become hot to the touch during use. This is normal.
- If the adapter causes radio interference, reorient or relocate the receiving antenna.

Using the Camera

Do not aim the camera at extremely bright light sources, such as the sun in a cloudless sky. Failure to observe this precaution could damage the camera image sensor.

Take Test Shots

Before taking photographs on important occasions (such as at weddings or before taking the camera on a trip), take a test shot and view the result in the LCD monitor to ensure that the camera is functioning normally. FUJIFILM Corporation can not accept liability for damages or lost profits incurred as a result of product malfunction.

Notes on Copyright

Unless intended solely for personal use, images recorded using your digital camera system cannot be used in ways that infringe copyright laws without the consent of the owner. Note that some restrictions apply to the photographing of stage performances, entertainments, and exhibits, even when intended purely for personal use. Users are also asked to note that the transfer of memory cards containing images or data protected under copyright laws is only permissible within the restrictions imposed by those copyright laws.

Handling

To ensure that images are recorded correctly, do not subject the camera to impact or physical shocks while images are being recorded.

Liquid Crystal

In the event that the LCD monitor is damaged, care should be taken to avoid contact with liquid crystal. Take the urgent action indicated should any of the following situations arise:

- **If liquid crystal comes in contact with your skin**, clean the area with a cloth and then wash thoroughly with soap and running water.
- **If liquid crystal enters your eyes**, flush the affected eye with clean water for at least 15 minutes and then seek medical assistance.
- **If liquid crystal is swallowed**, rinse your mouth thoroughly with water. Drink large quantities of water and induce vomiting, then seek medical assistance.

Although the display is manufactured using extremely high-precision technology, it may contain pixels that are always lit or that do not light. This is not a malfunction, and images recorded with the product are unaffected.

Trademark Information

xD-Picture Card and *.xP* are trademarks of FUJIFILM Corporation. The typefaces included herein are solely developed by Dyna-Comware Taiwan Inc. Macintosh, QuickTime, and Mac OS are trademarks of Apple Inc. in the U.S.A. and other countries. Windows 8, Windows 7, Windows Vista, and the Windows logo are trademarks of the Microsoft group of companies. Wi-Fi® and Wi-Fi Protected Setup® are registered trademarks of the Wi-Fi Alliance. Adobe and Adobe Reader are either trademarks or registered trademarks of Adobe Systems Incorporated in the U.S.A. and/or other countries. The SDHC and SDXC logos are trademarks of SD-3C, LLC. The HDMI logo is a trademark. YouTube is a trademark of Google Inc. All other trade names men-

tioned in this manual are the trademarks or registered trademarks of their respective owners.

Electrical Interference

This camera may interfere with hospital or aviation equipment. Consult with hospital or airline staff before using the camera in a hospital or on an aircraft.

Color Television Systems

NTSC (National Television System Committee) is a color television telecasting specification adopted mainly in the U.S.A., Canada, and Japan. PAL (Phases Alternation by Line) is a color television system adopted mainly in European countries and China.

Exif Print (Exif Version 2.3)

Exif Print is a newly revised digital camera file format in which information stored with photographs is used for optimal color reproduction during printing.

IMPORTANT NOTICE: Read Before Using the Software

Direct or indirect export, in whole or in part, of licensed software without the permission of the applicable governing bodies is prohibited.

NOTICES

To prevent fire or shock hazard, do not expose the unit to rain or moisture (excluding waterproof products).

Please read the "Safety Notes" and make sure you understand them before using the camera.

Perchlorate Material—special handling may apply. See <http://www.dtsc.ca.gov/hazardouswaste/perchlorate>.

For Customers in the U.S.A.

**Tested To Comply With FCC Standards
FOR HOME OR OFFICE USE**



Contains IC: 7736B-02000002

Contains FCC ID: W22-02000002

FCC Statement: This device complies with Part 15 of the FCC Rules. Operation is subject to the following two conditions: (1) This device may not cause harmful interference, and (2) this device must accept any interference received, including interference that may cause undesired operation.

CAUTION: This equipment has been tested and found to comply with the limits for a Class B digital device, pursuant to Part 15 of the FCC Rules. These limits are designed to provide reasonable protection against harmful interference in a residential installation. This equipment generates, uses, and can radiate radio frequency energy and, if not installed and used in accordance with the instructions, may cause harmful interference to radio communications. However, there is no guarantee that interference will not occur in a particular

installation. If this equipment does cause harmful interference to radio or television reception, which can be determined by turning the equipment off and on, the user is encouraged to try to correct the interference by one or more of the following measures:

- Reorient or relocate the receiving antenna.
- Increase the separation between the equipment and receiver.
- Connect the equipment into an outlet on a circuit different from that to which the receiver is connected.
- Consult the dealer or an experienced radio/TV technician for help.

FCC Caution: Any changes or modifications not expressly approved by the party responsible for compliance could void the user's authority to operate this equipment.

This transmitter must not be co-located or operating in conjunction with any other antenna or transmitter.

Radiation Exposure Statement: This device meets the government's requirements for exposure to radio waves. This device is designed and manufactured not to exceed the emission limits for exposure to radio frequency (RF) energy set by the Federal Communications Commission of the U.S. Government.

The exposure standard for wireless device employs a unit of measurement known as the Specific Absorption Rate, or SAR. The SAR limit set by the FCC is 1.6W/kg. *Tests for SAR are conducted using standard operating positions accepted by the FCC with the device transmitting at its highest certified power level in all tested frequency bands.

Notes on the Grant: To comply with Part 15 of the FCC Rules, this product must be used with a Fujifilm-specified ferrite-core A/V cable, USB cable, and DC supply cord.



A lithium ion battery that is recyclable powers the product you have purchased. Please call 1-800-8-BATTERY for information on how to recycle this battery.

For Customers in Canada

CAN ICES-3(B)/NMB-3(B)

CAUTION: This Class B digital apparatus complies with Canadian ICES-003.

Industry Canada statement: This device complies with RSS-210 of the Industry Canada Rules. Operation is subject to the following two conditions: (1) This device may not cause harmful interference, and (2) this device must accept any interference received, including interference that may cause undesired operation.

This device and its antenna(s) must not be co-located or operating in conjunction with any other antenna or transmitter, except tested built-in radios. The County Code Selection feature is disabled for products marketed in the US/ Canada.

Radiation Exposure Statement: The product complies with the Canada portable RF exposure limit set forth for an uncontrolled environment and are safe for intended operation as described in this manual. The further RF exposure reduction can be achieved if the product can be kept as far as possible from the user body or set the device to lower output power if such function is available.

IMPORTANT SAFETY INSTRUCTIONS

- Read these instructions.
- Keep these instructions.
- Heed all warnings.
- Follow all instructions.
- Do not use this apparatus near water.
- Clean only with a dry cloth.
- Do not block any ventilation openings. Install in accordance with the manufacturer's instructions.
- Do not install near any heat sources such as radiators, heat registers, stoves, or other apparatus (including amplifiers) that produce heat.
- Protect the power cord from being walked on or pinched particularly at plugs, convenience receptacles, and the point where they exit from the apparatus.
- Only use attachments/accessories specified by the manufacturer.
- Unplug this apparatus during lightning storms or when unused for long periods of time.
- Refer all servicing to qualified service personnel. Servicing is required when the apparatus has been damaged in any way, such as power supply cord or plug is damaged, liquid has been spilled or objects have fallen into the apparatus, the apparatus has been exposed to rain or moisture, does not operate normally, or has been dropped.

Disposal of Electrical and Electronic Equipment in Private Households

In the European Union, Norway, Iceland and Liechtenstein: This symbol on the product, or in the manual and in the warranty, and/or on its packaging indicates that this product shall not be treated as household waste. Instead it should be taken to an applicable collection point for the recycling of electrical and electronic equipment.

By ensuring this product is disposed of correctly, you will help prevent potential negative consequences to the environment and human health, which could otherwise be caused by inappropriate waste handling of this product.

This symbol on the batteries or accumulators indicates that those batteries shall not be treated as household waste.

If your equipment contains easy removable batteries or accumulators please dispose these separately according to your local requirements.

The recycling of materials will help to conserve natural resources. For more detailed information about recycling this product, please contact your local city office, your household waste disposal service or the shop where you purchased the product.

In Countries Outside the European Union, Norway, Iceland and Liechtenstein: If you wish to discard this product, including the batteries or accumulators, please contact your local authorities and ask for the correct way of disposal.



In Japan: This symbol on the batteries indicates that they are to be disposed of separately.



Li-ion

European Union regulatory notice

This product complies with the following EU Directives:

- Low Voltage Directive 2006/95/EC
- EMC Directive 2004/108/EC
- R & TTE Directive 1999/5/EC

Compliance with these directives implies conformity to applicable harmonized European standards (European Norms) which are listed on the EU Declaration of Conformity issued by FUJIFILM Corporation for this product or product family.

This compliance is indicated by the following conformity marking placed on the product:



This marking is valid for non-Telecom products and EU harmonized Telecom products (e.g. Bluetooth).

Regarding the Declaration of Conformity, visit http://www.fujifilm.com/products/digital_cameras/x/fujifilm_xq1/pdf/index/fujifilm_xq1_cod.pdf.

IMPORTANT: Read the following notices before using the camera's built-in wireless transmitter.

Ⓢ This product, which contains encryption function developed in the United States, is controlled by the United States Export Administration Regulations and may not be exported or re-exported to any country to which the United States embargoes goods.

- **Use only as part of a wireless network.** FUJIFILM does not accept liability for damages resulting from unauthorized use. Do not use in applications requiring a high degree of reliability, for example in medical devices or other systems that may directly or indirectly impact human life. When using the device in computer and other systems that demand a greater degree of reliability than wireless networks, be sure to take all necessary precautions to ensure safety and prevent malfunction.
- **Use only in the country in which the device was purchased.** This device conforms to regulations governing wireless network devices in the country in which it was purchased. Observe all location regulations when using the device. FUJIFILM does not accept liability for problems arising from use in other jurisdictions.
- **Wireless data (images) may be intercepted by third parties.** The security of data transmitted over wireless networks is not guaranteed.

- **Do not use the device in locations subject to magnetic fields, static electricity, or radio interference.** Do not use the transmitter in the vicinity of microwave ovens or in other locations subject to magnetic fields, static electricity, or radio interference that may prevent reception of wireless signals. Mutual interference may occur when the transmitter is used in the vicinity of other wireless devices operating in the 2.4 GHz band.

• **The wireless transmitter operates in the 2.4 GHz band using DSSS and OFDM modulation.**

- **The wireless transmitter operates in the 2.4 GHz band using DSSS and OFDM modulation.**

Wireless Network Devices: Cautions

- **This device operates on the same frequency as commercial, educational, and medical devices and wireless transmitters.** It also operates on the same frequency as licensed transmitters and special unlicensed low-voltage transmitters used in RFID tracking systems for assembly lines and in other similar applications.
- **To prevent interference with the above devices, observe the following precautions.** Confirm that the RFID transmitter is not in operation before using this device. Should you observe that the device causes interference in licensed transmitters used for RFID tracking, immediately choose a new operating frequency for this device to prevent additional interference. If you notice that this device causes interference in low-voltage RFID tracing systems, contact a FUJIFILM representative.

2.4DS/OF4

This sticker indicates that this device operates in the 2.4 GHz band using DSSS and OFDM modulation and may cause interference at distances of up to 40 m.

About This Manual

Before using the camera, read this manual and the warnings in “For Your Safety” (📖 ii). For information on specific topics, consult the sources below.

Table of Contents 📖 xi

The “Table of Contents” gives an overview of the entire manual. The principal camera operations are listed here.

Troubleshooting 📖 128

Having a specific problem with the camera? Find the answer here.

Warning Messages and Displays ... 📖 134

Find out what’s behind that flashing icon or error message in the display.

●● **Memory Cards**

Pictures can be stored in the camera’s internal memory or on optional SD, SDHC, and SDXC memory cards (📖 15), referred to in this manual as “memory cards.”









●● **Temperature Warning**













The camera will turn off automatically before its temperature or the temperature of the battery rise above safe limits. Pictures taken when a temperature warning is displayed may exhibit higher levels of “noise” (mottling). Turn the camera off and wait for it to cool before turning it on again.

Table of Contents

For Your Safety	ii
Safety Notes.....	ii
NOTICES.....	vii
About This Manual	x
Before You Begin	
Symbols and Conventions.....	1
Supplied Accessories	1
Parts of the Camera	2
Camera Displays.....	6
Shooting	6
Playback.....	7
Display mode	9
First Steps	
Inserting the Battery and a Memory Card.....	12
Compatible Memory Cards	15
Charging the Battery	17
Turning the Camera on and Off	19
Shooting Mode	19
Playback Mode.....	19
Basic Setup	21
Basic Photography and Playback	
Taking Pictures.....	22
Viewing Pictures	26

More on Photography

Shooting Mode.....	27
SR ⁺ ADVANCED SR AUTO	28
Filter ADVANCED FILTER.....	30
Adv. ADVANCED	30
 MOTION PANORAMA 360.....	31
 PRO FOCUS.....	33
 PRO LOW-LIGHT.....	34
 MULTIPLE EXPOSURE.....	35
SP SCENE POSITION.....	36
M MANUAL	37
A APERTURE PRIORITY AE.....	38
S SHUTTER PRIORITY AE	39
P PROGRAM AE.....	40
C CUSTOM MODE.....	41
Focus Lock	42
 Exposure Compensation	44
 Macro Mode (Close-ups)	45
 Using the Flash (Super-Intelligent Flash)	46
 Using the Self-Timer	48
The E-Fn Button.....	49
Using the E-Fn BUTTON CUSTOM SETTING Menu	49
Changing functions assigned to the control ring	50

 Continuous Shooting	52
 TOP <i>n</i>	53
 BEST FRAME CAPTURE	53
 AE BKT	55
 ISO BKT	55
 FILM SIMULATION BKT	55
 DYNAMIC RANGE BKT	56
 Focus Mode	57
Focus indicator	57
Focus Frame Selection	59
 Intelligent Face Detection	60
More on Playback	
Playback Options	61
Continuous Shooting	61
★ Favorites: Rating Pictures	61
Playback Zoom	62
Multi-Frame Playback	63
 Deleting Pictures	64
 Image Search	65
 PhotoBook Assist	66
Creating a PhotoBook	66
Viewing Photobooks	67
Editing and Deleting Photobooks	67
Viewing Panoramas	68
Viewing Photo Information	69

Wireless Networks

Using Wireless Networks	71
Connecting with smartphones	71
Saving Pictures to a Computer	71





Movies











































Recording Movies	72
Movie Frame Size	74
Viewing Movies	75

Connections

Viewing Pictures on High-Definition TVs	76
Printing Pictures via USB	77
Printing the DPOF Print Order	79
Viewing Pictures on a Computer	81
Windows: Installing MyFinePix Studio	81
Macintosh: Installing RAW FILE CONVERTER	84
Importing Pictures or Movies to Mac (Macintosh)	85
Connecting the Camera	86

Menus

Using the Menus: Shooting Mode	89
Using the Shooting Menu	89
Shooting Menu Options	90
 SCENE POSITION	90
 ADVANCED FILTER	90
 Adv. MODE	90
 ISO	90

 IMAGE SIZE.....	92	 MOVIE SET-UP	102
 IMAGE QUALITY	93	 CUSTOM SET	102
 D-Rng DYNAMIC RANGE	93	Using the Menu: Playback Mode	103
 FILM SIMULATION	94	Using the Playback Menu	103
 FILM SIMULATION BKT	94	Playback Menu Options.....	104
 WB WHITE BALANCE	95	 WIRELESS COMMUNICATION	104
 COLOR.....	97	 PC AUTO SAVE.....	104
 Sharp SHARPNESS	97	 IMAGE SEARCH	104
 Highlight TONE	97	 ERASE	104
 Shadow TONE.....	98	 MARK FOR UPLOAD TO	105
 NR NOISE REDUCTION.....	98	 SLIDE SHOW	106
 Continuous.....	98	 RAW RAW CONVERSION.....	107
 Advanced ANTI BLUR	98	 RED EYE REMOVAL	109
 Face DETECTION	98	 PROTECT.....	109
 PhotOMETRY	98	 CROP	110
 P-AF PRE-AF.....	99	 RESIZE.....	110
 AF AF MODE.....	99	 IMAGE ROTATE	111
 Focus MODE.....	100	 COPY.....	111
 Focus AREA	100	 PHOTOBOOK ASSIST.....	112
 MF MF ASSIST.....	100	 PRINT ORDER (DPOF).....	112
 E-Fn E-Fn BUTTON CUSTOM SETTING.....	100	 DISP ASPECT	112
 Control RING SETTING.....	100		
 DISP: CUSTOM SETTING	101		
 Flash COMPENSATION.....	101		

The Setup Menu	113
Using the Setup Menu	113
Setup Menu Options	114
🕒 DATE/TIME	114
🕒 TIME DIFFERENCE	114
🗣️ 言語/LANG.	114
🔄 RESET	115
🔇 SILENT MODE	115
🕒 CONTROL RING	115
MF FOCUS CHECK	115
📷 GEOTAGGING SET-UP	115
🎵 SOUND SET-UP	116
📺 SCREEN SET-UP	117
🔋 POWER MANAGEMENT	118
📺 IS MODE	119
👁️ RED EYE REMOVAL	119
🔍 INTELLIGENT DIGITAL ZOOM	120
AF AF ILLUMINATOR	120
💾 SAVE DATA SET-UP	121
🔄 CUSTOM RESET	122
📶 WIRELESS SETTINGS	123
🖨️ PC AUTO SAVE SETTING	123
🗑️ FORMAT	123

Technical Notes

Optional Accessories	124
Accessories from FUJIFILM	125
Caring for the Camera	126
Storage and Use	126
Cleaning	127
Traveling	127

Troubleshooting

Problems and Solutions	128
Warning Messages and Displays	134

Appendix

Memory Card Capacity	138
Specifications	139

Before You Begin

Symbols and Conventions

The following symbols are used in this manual:

- ⓘ : This information should be read before use to ensure correct operation.
- 📖 : Additional information that may be helpful when using the camera.
- 📖 : Other pages in this manual on which related information may be found.

Menus and other text in the displays are shown in **bold**. In the illustrations in this manual, displays may be simplified for explanatory purposes.

Supplied Accessories

The following items are included with the camera:

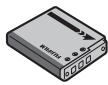

NP-48 Rechargeable
battery



AC power adapter



Plug adapter*

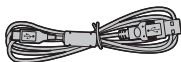

USB cable



CD-ROM (contains this
manual)

• Strap

Attaching the Strap

Attach the strap **1**
as shown.

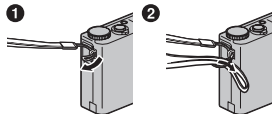

* Shape of adapter varies with region of sale.

Parts of the Camera

For more information, refer to the page listed to the right of each item.

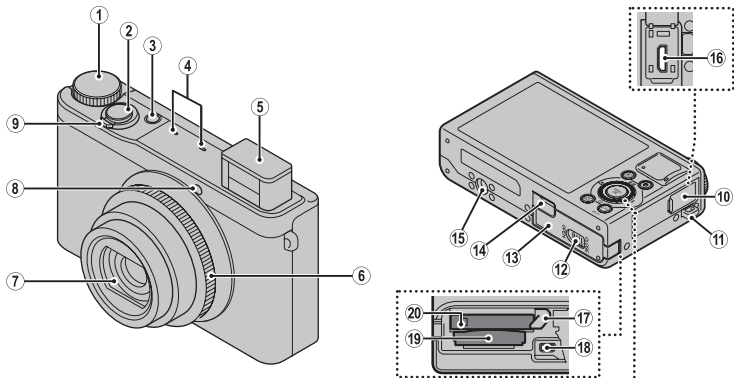

Selector button

Move cursor up

- (exposure compensation) button (44)
- (delete) button (26)

MENU/OK button

Move cursor left

- (macro) button (45)

Move cursor right

- (flash) button (46)

Command dial (4)

Move cursor down

- (self-timer) button (48)

* The illustrations in this manual have been simplified for explanatory purposes.

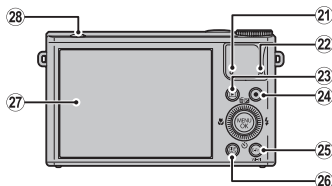

① Mode dial	27	⑩ USB terminal cover	17, 77, 86
② Shutter button	24	⑪ Strap eyelet	1
③ ON/OFF button	19	⑫ Battery-chamber cover latch	12
④ Microphone	72	⑬ Battery-chamber cover	12
⑤ Flash	46	⑭ HDMI terminal cover	76
⑥ Control ring.....	4	⑮ Tripod mount	
⑦ Lens cover	19	⑯ USB multi-connector	17, 77, 86
⑧ AF-assist illuminator.....	120	⑰ Battery latch	12, 14
Self-timer lamp	48	⑱ Connector for HDMI cable	76
⑨ Zoom control	23, 62	⑲ Memory card slot.....	13
		⑳ Battery chamber	12
		㉑ Indicator lamp	5
		㉒ Speaker.....	75
		㉓ (playback) button	26, 61
		㉔ (movie recording) button	72
		㉕ E-Fn (extended function) button	49
		Monitor sunlight mode.....	8
		Wi-Fi button (playback mode)	71
		㉖ DISP (display)/ BACK button	9, 21, 69
		㉗ LCD monitor.....	6
		㉘ (flash pop-up) Switch.....	46

Command dial

Rotate the command dial to set the aperture value or shutter speed. You can also select items using the command dial for the selector button.



Control ring

With the control ring, you can change zoom ratio, aperture value, shutter speed, and others in the default settings. Besides, functions such as exposure compensation can be assigned to the control ring using **E-Fn** button (📖 50).

Default functions of the control ring







Shooting mode	Descriptions
SR+	Zoom
Camera	Zoom/MF ^{*1}
P	Program shift/MF ^{*1}
A	Aperture/MF ^{*1}
S	Shutter speed/MF ^{*1}
M	Aperture/Shutter speed ^{*2} /MF ^{*1}
Adv.	Advanced mode selection
Filter	Advanced filter selection
SP	Scene position selection/MF ^{*1}
Movie	Zoom/MF ^{*1}

*1 When **MF MANUAL FOCUS** is selected for **FOCUS MODE**, the control ring is used to focus manually (📖 57).

*2 Press the sector up () to change the setting item between shutter speed and aperture.

◆ Setting values appear in the LCD monitor when using the control ring.

Control Lock

To lock the selector button ( /  /  / ) and the **E-Fn** button, press **MENU/OK** until  is displayed. This prevents accidental operation during shooting. The controls can be unlocked by pressing **MENU/OK** until  is no longer displayed.

The Indicator Lamp (when the camera is on)

The indicator lamp shows camera status as follows:

Indicator lamp	Camera status
Glows green	Focus locked.
Blinks green	Blur, focus, or exposure warning. Picture can be taken.
Blinks green and orange	Recording pictures. Additional pictures can be taken.
Glows orange	Recording pictures. No additional pictures can be taken at this time.
Blinks orange	Flash charging; flash will not fire when picture is taken.
Blinks red	Lens or memory error.

Camera Displays

The following types of indicator may be displayed during shooting and playback. Indicators vary with camera settings.

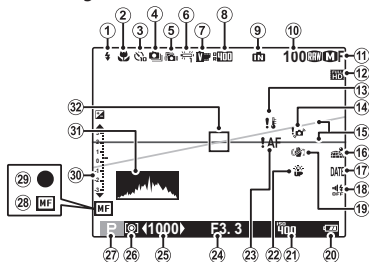
Shooting

① Flash mode	46
② Macro (close-up) mode	45
③ Self-timer indicator	48
④ Continuous shooting mode	52
⑤ Advanced anti blur	29
⑥ White balance	95
⑦ Film simulation	94
⑧ Dynamic range	93
⑨ Internal memory indicator *	
⑩ Number of available frames	138
⑪ Image size/quality	92
⑫ Movie mode	74

⑬ Temperature warning	x, 134
⑭ Blur warning	47, 134
⑮ Electronic level	101
⑯ Location data download status	71
⑰ Date stamp	122
⑱ Silent mode indicator	115
⑲ IS mode	119
⑳ Battery status	8
㉑ Sensitivity	90
㉒ Monitor sunlight mode	8
㉓ Focus warning	25, 134
㉔ Aperture	37, 38
㉕ Shutter speed	37, 39
㉖ Metering	98
㉗ Shooting mode	27
㉘ Manual focus indicator	57
㉙ Focus indicator	25, 57
㉚ Exposure indicator	44
㉛ Histogram	11
㉜ Focus frame	42

* **IN**: indicates that no memory card is inserted and that pictures will be stored in the camera's internal memory (📖 13).



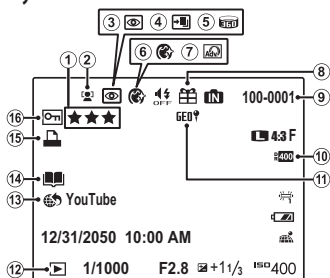



■ Playback



① Favorites	61
② Intelligent Face Detection indicator	60, 98
③ Red-eye removal indicator	109
④ Pro focus mode, pro low-light mode	33, 34
⑤ Motion panorama	31, 68
⑥ Portrait enhancer	36
⑦ Advanced Filter	30
⑧ Gift image	61
⑨ Frame number	121
⑩ Dynamic range	93
⑪ Location data	115
⑫ Playback mode indicator	26, 61
⑬ Mark for upload to	105
⑭ Photobook assist	66
⑮ DPOF print indicator	79
⑯ Protected image	109

Battery status

Battery status is shown as follows:

Indicator	Description
 (white)	Battery partially discharged.
 (white)	Battery more than half discharged.
 (red)	Low battery. Charge as soon as possible.
 (blinks red)	Battery exhausted. Charge battery.
 (yellow)	Battery charging.
 (green)	Charging complete.
 (red)	Battery fault. See page 129.
No icon	Operating in external power mode.

Bright Ambient Lighting

Reflections and glare caused by bright ambient lighting may make it hard to see the display in the monitor, particularly when the camera is used outdoors. This can be addressed by holding the **E-Fn** button to trigger outdoor mode. This function is available in the shooting mode. Outdoor mode can also be enabled using the

 **SCREEN SET-UP > MONITOR SUNLIGHT MODE** option ( 117).

Display mode

Press **DISP/BACK** to cycle through display modes as follows:

- Shooting

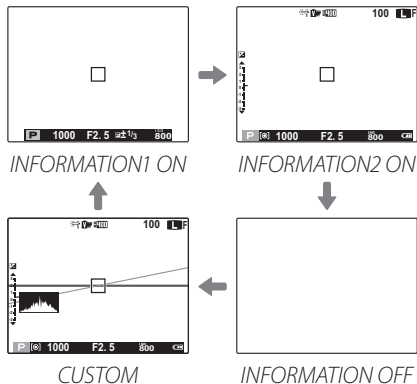

- ◆ INFORMATION1 is available only when an option other than **TRACKING** is selected for **AF AF MODE** in modes **P**, **S**, **A**, and **M**.

Custom Display

- Choose items for display using **DISP. CUSTOM SETTING** in the shooting menu (101). See 6, 7 for the positions of displayed items in the LCD monitor.
- When custom setting is complete, press **DISP/BACK** a few times for **CUSTOM** display.

• Playback

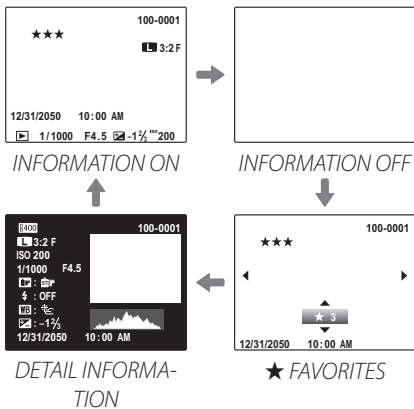

Histograms

Histograms show the distribution of tones in the image. Brightness is shown by the horizontal axis, the number of pixels by the vertical axis.

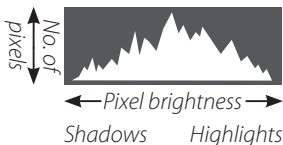

Optimal exposure: Pixels are distributed in an even curve throughout the tone range.

Overexposed: Pixels are clustered at the right side of the graph.

Underexposed: Pixels are clustered at the left side of the graph.

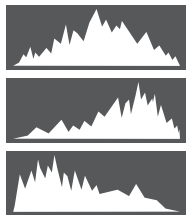

First Steps

Inserting the Battery and a Memory Card

Insert the battery and memory card as described below.

1 Open the battery-chamber cover.

- ◆ Be sure the camera is off before opening the battery-chamber cover.
- Ⓛ Do not open the battery-chamber cover when the camera is on. Failure to observe this precaution could result in damage to image files or memory cards.
- Ⓛ Do not use excessive force when handling the battery-chamber cover.

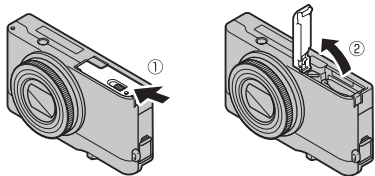

2 Insert the battery.

Align the orange stripe on the battery with the orange battery latch and slide the battery into the camera, keeping the battery latch pressed to one side. Confirm that the battery is securely latched.

- Ⓛ Insert the battery in the correct orientation. **Do NOT use force or attempt to insert the battery upside down or backwards.** The battery will slide in easily in the correct orientation.

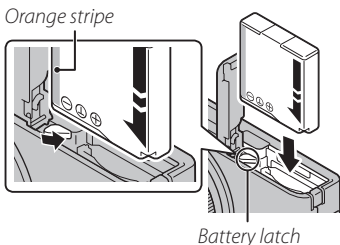

3 Insert the memory card.

Holding the memory card in the orientation shown at right, slide it in until it clicks into place at the back of the slot.

- ① Be sure card is in the correct orientation; do not insert at an angle or use force. If the memory card is not correctly inserted or no memory card is inserted, **IN** will appear in the LCD monitor and internal memory will be used for recording and playback.
- ① SD/SDHC/SDXC memory cards can be locked, making it impossible to format the card or to record or delete images. Before inserting an SD/SDHC/SDXC memory card, slide the write-protect switch to the unlocked position.

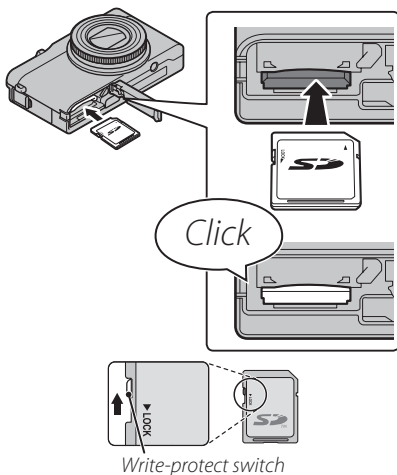

4 Close the battery-chamber cover.

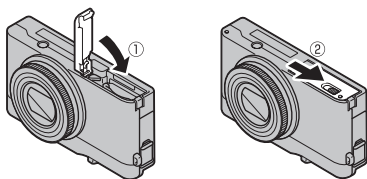

●● Removing the Battery and Memory Card

Before removing the battery or memory card, *turn the camera off* and open the battery-chamber cover.

To remove the battery, press the battery latch to the side, and slide the battery out of the camera as shown.

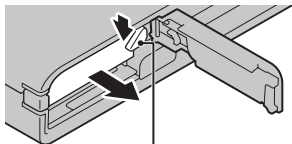

Battery latch

To remove the memory card, press it in and release it slowly. The card can then be removed by hand. When a memory card is removed, the card could come out of the slot too quickly. Use your finger to hold it and gently release the card.

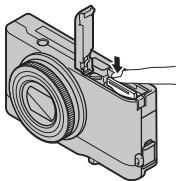

■ Compatible Memory Cards

FUJIFILM and SanDisk SD, SDHC, and SDXC memory cards have been approved for use in the camera. A complete list of approved memory cards is available at http://www.fujifilm.com/support/digital_cameras/compatibility/. Operation is not guaranteed with other cards. The camera can not be used with *xD-Picture Cards* or MultiMediaCard (MMC) devices.

ⓘ Memory Cards

- *Do not turn the camera off or remove the memory card while the memory card is being formatted or data are being recorded to or deleted from the card.* Failure to observe this precaution could damage the card.
- Format SD/SDHC/SDXC memory cards before first use, and be sure to reformat all memory cards after using them in a computer or other device. For more information on formatting memory cards, see “ **FORMAT**” (📖 123).
- Memory cards are small and can be swallowed; keep out of reach of children. If a child swallows a memory card, seek medical assistance immediately.
- miniSD or microSD adapters that are larger or smaller than the standard dimensions of an SD/SDHC/SDXC card may not eject normally; if the card does not eject, take the camera to an authorized service representative. Do not forcibly remove the card.
- Do not affix labels to memory cards. Peeling labels can cause camera malfunction.
- Movie recording may be interrupted with some types of SD/SDHC/SDXC memory card. Use a **CLASS 10** card or better when shooting HD or high-speed movies.

- The data in internal memory may be erased or corrupted when the camera is repaired. Please note that the repairer will be able to view pictures in internal memory.
- Formatting a memory card or internal memory in the camera creates a folder in which pictures are stored. Do not rename or delete this folder or use a computer or other device to edit, delete, or rename image files. Always use the camera to delete pictures from memory cards and internal memory; before editing or renaming files, copy them to a computer and edit or rename the copies, not the originals.

① **Batteries**

- Remove dirt from the battery terminals with a clean, dry cloth. Failure to observe this precaution could prevent the battery from charging.
- Do not affix stickers or other objects to the battery. Failure to observe this precaution could make it impossible to remove the battery from the camera.
- Do not short the battery terminals. The battery could overheat.
- Read the cautions in “The Battery and Power Supply” (📖 iv).
- Use only battery chargers designated for use with the battery. Failure to observe this precaution could result in product malfunction.
- Do not remove the labels from the battery or attempt to split or peel the outer casing.
- The battery gradually loses its charge when not in use. Charge the battery one or two days before use.

Charging the Battery

The battery is not charged at shipment. Charge the battery before use. The camera charges the battery internally.

1 Attach the plug adapter to the AC power adapter.

Attach the plug adapter as shown, making sure that it is fully inserted and clicks into place on the AC power adapter terminals.

- ⓘ The plug adapter is exclusively for use with the supplied AC power adapter. Do not use it with other devices.

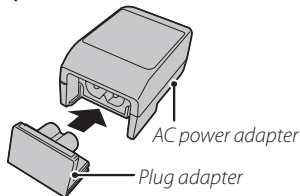

2 Charge the battery.

Connect the camera to the supplied AC power adapter using the supplied USB cable. Then plug the AC power adapter into an indoor power outlet.

- ⓘ Be sure the connectors are in the correct orientation and then insert them fully.

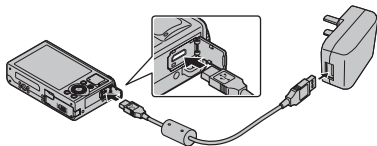



The camera uses an NP-48 rechargeable battery.

- ⓘ The battery will not charge while the camera is in the shooting mode.
- ⚡ The camera operates in external power mode if the camera is turned on while the camera is connected to AC power and the battery is inserted.

Charge status

The battery status icons show battery charge status when the camera is turned on, and the indicator lamp shows it when the camera is turned off.

Battery status icon when camera on	Indicator lamp when camera off	Battery status	Action
 (yellow)	On	Battery charging.	—
 (green)	Off	Charging complete.	—
 (red)	Blinks	Battery fault.	See page 129.

Charging via a computer

The battery can be charged by connecting the camera to a computer.

Connect the supplied USB cable as shown, making sure the connectors are fully inserted. Connect the camera directly to the computer; do not use a USB hub or keyboard.

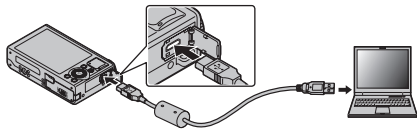

- ⓘ If the computer goes into sleep mode while charging, charging will stop. To continue charging, disable sleep mode on the computer, and disconnect and connect the USB cable.
- ⓘ Charging may be impossible depending on computer specifications, settings or conditions.

Turning the Camera on and Off

Shooting Mode

Press the **ON/OFF** button to turn the camera on. The lens will extend automatically.

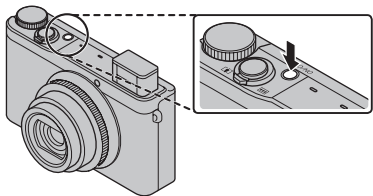

Press **ON/OFF** again to turn the camera off.

◆ **Switching to Playback Mode**

Press the **▶** button to start playback. Press the shutter button halfway to return to shooting mode.

Playback Mode

To turn the camera on and begin playback, press the **▶** button for about a second.

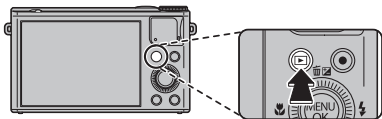

Press the **▶** button again or press the **ON/OFF** button to turn the camera off.

◆ **Switching to Shooting Mode**

To exit to shooting mode, press the shutter button halfway. Press the **▶** button to return to playback.

- ⓘ Forcibly obstructing the lens could cause damage or product malfunction.
- ⓘ Fingerprints and other marks on the lens can affect pictures. Keep the lens clean.
- ⓘ The **ON/OFF** button does not completely end the supply of power to the camera.

🔍 **Auto Power Off**

The camera will turn off automatically if no operations are performed for the length of time selected for  **POWER MANAGEMENT > AUTO POWER OFF** (📖 118).

Basic Setup

A language-selection dialog is displayed the first time the camera is turned on. Set up the camera as described below (you can reset the clock or change languages at any time using the 🕒 **DATE/TIME** or 🗣️ **言語/LANG.** options in the setup menu; for information on displaying the setup menu, see page 113).

1 Highlight a language and press **MENU/OK**.

- ◆ Press **DISP/BACK** to skip the current step. Any steps you skip will be displayed the next time the camera is turned on.

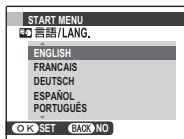

2 The date and time will be displayed. Press the selector left or right to highlight the year, month, day, hour, or minute and press up or down to change. To change the order in which the year, month, and day are displayed, highlight the date format and press the selector up or down. Press **MENU/OK** when settings are complete.

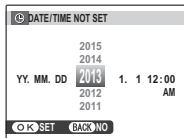

3 Power management options will be displayed. Press the selector up or down to highlight one of the following options and then press **MENU/OK**:

- 📶 **POWER SAVE**: Save battery power.
- 📶 **HIGH PERFORMANCE**: Choose for a brighter display and faster focus.

◆ The Camera Clock

If the battery is removed for an extended period, the camera clock will be reset and the language-selection dialog will be displayed when the camera is turned on.

Basic Photography and Playback

Taking Pictures

This section explains basic photography.

1 Select **SR+** mode.

Rotate the mode dial to **SR+** (ADVANCED SR AUTO). The following information will be displayed in the LCD monitor.

Scene Icon (📖 28)

The camera automatically selects the appropriate scene.



The Icon

In **SR+** mode, the camera continuously adjusts focus and searches for faces, increasing the drain on the battery.  is displayed in the LCD monitor.

- ◆ To raise the flash when lighting is poor, slide the flash pop-up switch (📖 46).

2 Frame the picture.

Use the zoom control to frame the picture in the display.

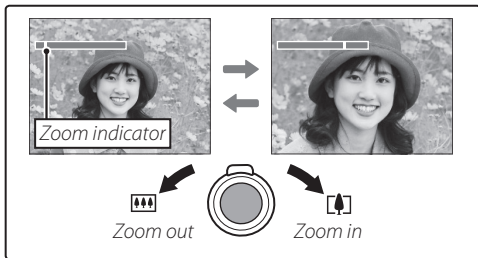

Control ring

You can use the control ring to change the zoom ratio.

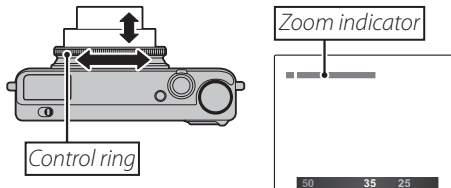

 You may need to change the control ring setting ( 50).

Holding the Camera

Hold the camera steady with both hands and brace your elbows against your sides. Shaking or unsteady hands can blur your shots.

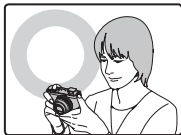

To prevent pictures that are out of focus or too dark (underexposed), keep your fingers and other objects away from the lens and flash.

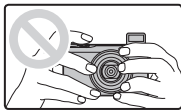

3 Focus.

Press the shutter button halfway to focus.

- ◆ The lens may make a noise when the camera focuses; this is normal. If the subject is poorly lit, the AF-assist illuminator may light; see “**AF² AFILLUMINATOR**” (120) for information on disabling the illuminator.

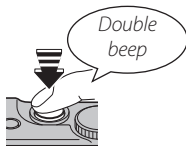

If the camera is able to focus, it will beep twice and the indicator lamp will glow green. And the focus indicator will glow green.

If the camera is unable to focus, the focus frame will turn red, **!AF** will be displayed, and the indicator lamp will blink green. And the focus indicator will blink white. Change the composition or use focus lock (📖 42).

4 Shoot.

Smoothly press the shutter button the rest of the way down to take the picture.



The Shutter Button

The shutter button has two positions. Pressing the shutter button halfway sets focus and exposure; to shoot, press the shutter button the rest of the way down.

Viewing Pictures

Pictures can be viewed in the LCD monitor. When taking important photographs, take a test shot and check the results.

1 Press the button.

The most recent picture will be displayed.

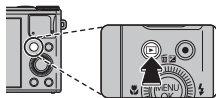

2 View additional pictures.

Press the selector right to view pictures in the order recorded, left to view pictures in reverse order.

Press the shutter button to exit to shooting mode.

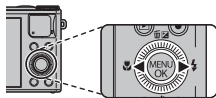

Deleting Pictures

To delete the picture currently displayed in the monitor, press the selector up () and choose from the options.

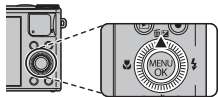

To exit without deleting the picture, highlight **CANCEL** and press **MENU/OK**.

 Pictures can also be deleted from the playback menu ( 64).

More on Photography

Shooting Mode

Choose a shooting mode according to the scene or type of subject. To select a shooting mode, align the mode icon with the mark next to the mode dial.

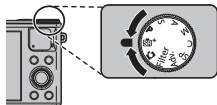

M, A, S, P: Select for full control over camera settings (📖 37), including aperture (**M** and **A**) and/or shutter speed (**M** and **S**).

SR+ (ADVANCED SR AUTO): The camera automatically optimizes settings to the scene (📖 28).

📷 (AUTO): A simple “point-and-shoot” mode recommended for first-time users of digital cameras.

Filter (ADVANCED FILTER): Select for taking photos with filter effects (📖 30).

C (CUSTOM): Recall stored settings for modes **P**, **S**, **A**, and **M** (📖 41).

SP (SCENE POSITION): Choose a scene suited to the subject or shooting conditions and let the camera do the rest (📖 36).

Adv. (ADVANCED): Sophisticated techniques made easy (📖 30).



SR⁺ ADVANCED SR AUTO

When the mode dial is rotated to **SR⁺**, the camera automatically optimizes settings to suit the scene.



The scene is shown by an icon in the display.

*The Scene Icon*



Main subject		Scene										
		AUTO	LAND-SCAPE	NIGHT	NIGHT (TRIPOD)	MACRO	BEACH	SUNSET	SNOW	SKY	GREEN-ERY	SKY & GREEN-ERY
Non-portrait												
Portrait	Normal					—						
	Backlit			—	—	—						
Moving object												
Portrait and motion	Normal					—						
	Backlit			—	—	—						

* If is displayed, the camera will take a series of shots (advanced anti-blur; [29](#)).

① The mode selected may vary with shooting conditions. If the mode and subject do not match, select mode ([27](#)) or choose **SP** ([36](#)) and select a scene manually.













Advanced Anti Blur

When  is displayed, the camera will take a series of exposures and combine them to form a single image, reducing “noise” (mottling) and blur.

- ◆  is available when **ON** is selected for  **ADVANCED ANTI BLUR** (📖 98) and the flash (📖 46) is off or set to auto.
- ① Some time may be required to combine the exposures into a single image. A single combined image may not be created if the subject or camera moves during shooting. Keep the camera steady during shooting and do not move the camera until shooting is complete.
- ① Frame coverage is reduced.

Filter *ADVANCED FILTER*

Take photos with filter effects. Choose from the following filters.

Filter	Description
 TOY CAMERA	Choose for a retro toy camera effect.
 MINIATURE	The tops and bottoms of pictures are blurred for a diorama effect.
 POP COLOR	Create high-contrast images with saturated colors.
 HIGH-KEY	Create bright, low-contrast images.
 LOW-KEY	Create uniformly dark tones with few areas of emphasized highlights.
 DYNAMIC TONE	Dynamic tone expression is used for a fantasy effect.
 SOFT FOCUS	Create a look that is evenly soft throughout the whole image.
 PARTIAL COLOR (RED)	Areas of the image that are the selected color are recorded in that color. All others areas of the image are recorded in black-and-white.
 PARTIAL COLOR (ORANGE)	
 PARTIAL COLOR (YELLOW)	
 PARTIAL COLOR (GREEN)	
 PARTIAL COLOR (BLUE)	
 PARTIAL COLOR (PURPLE)	

- Depending on the subject and camera settings, images may in some cases be grainy or vary in brightness and hue.

Adv. *ADVANCED*

This mode combines “point-and-shoot” simplicity with sophisticated photographic techniques. The  **Adv. MODE** option can be used to choose from the following advanced modes:



MOTION PANORAMA 360

Follow an on-screen guide to take photos that will automatically be joined to form a panorama. The camera zooms all the way out and remains fixed at the widest angle until shooting is complete.



- 1 To select the angle through which you will pan the camera while shooting, press the selector down. Press the selector left or right to highlight an angle and press **MENU/OK**.
- 2 Press the selector right to view a choice of pan directions. Press the selector left or right to highlight a pan direction and press **MENU/OK**.
- 3 Press the shutter button all the way down to start recording. There is no need to keep the shutter button pressed during recording.
- 4 Pan the camera in the direction shown by the arrow. Shooting ends automatically when the progress bar is full and the panorama is complete.

- ◆ Shooting ends if the shutter button is pressed all the way down during shooting. No panorama will be recorded if the shutter button is pressed before the camera has been panned through 120°.

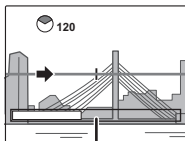





Progress bar

- ① Panoramas are created from multiple frames. The camera may in some cases record an greater or lesser angle than selected or be unable to stitch the frames together perfectly. The last part of the panorama may not be recorded if shooting ends before the panorama is complete.
- ① Shooting may be interrupted if the camera is panned too quickly or too slowly. Panning the camera in a direction other than that shown cancels shooting.
- ① The desired results may not be achieved with moving subjects, subjects close to the camera, unvarying subjects such as the sky or a field of grass, subjects that are in constant motion, such as waves and waterfalls, or subjects that undergo marked changes in brightness. Panoramas may be blurred if the subject is poorly lit.



Choose  for seamless 360° panoramas that can be played back in a loop (📖 68).

- ◆ The  **SAVE DATA SET-UP > SAVE ORG IMAGE** option can be used to record a  panorama in addition to a seamless  panorama (📖 121).
- ① Depending on the subject and shooting conditions, the camera may produce distorted results or a  panorama. The top and bottom of the area visible in the shooting display are cropped out and white strips may appear at the top and bottom of the display.

For Best Results

For best results, move the camera in a small circle at a steady speed, keeping the camera horizontal and being careful only to pan in the direction shown by the guides. If the desired results are not achieved, try panning at a different speed.

■ PRO FOCUS

The camera takes up to three shots each time the shutter button is pressed, softening the background to emphasize the main subject. The amount of softening can be adjusted before shooting by rotating the command dial. Use for portraits or photos of flowers similar to those produced by SLR cameras.



- ◆ Softening can not be applied to background objects that are too close to the main subject. If a message stating that the camera can not create the effect is displayed when the camera focuses, try backing away from your subject and zooming in. The camera may also be unable to soften the background if the subject is moving; if prompted, check the results and try again.
- ⓘ Frame coverage is reduced.

PRO LOW-LIGHT

Each time the shutter button is pressed, the camera makes four exposures and combines them into a single photograph. Use to reduce noise and blur when photographing poorly lit subjects or static subjects at high zoom ratios.



- ◆ A single combined photograph may not be created with some scenes or if the subject or camera moves during shooting. Do not move the camera until shooting is complete.

PRO FOCUS/PRO LOW-LIGHT

To save unprocessed copies of pictures taken in these modes, select **ON** for  **SAVE DATA SET-UP > SAVE ORG IMAGE** (📖 121).

- ① Keep the camera steady during shooting.

■ MULTIPLE EXPOSURE









Create a photograph that combines two exposures.





- 1 Take the first shot.
- 2 Press **MENU/OK**. The first shot will be shown superimposed on the view through the lens as a guide to taking the second shot.
 - ◆ To return to Step 1 and retake the first shot, press the selector left. To save the first shot and exit without creating a multiple exposure, press **DISP/BACK**.
- 3 Take the second shot.
- 4 Press **MENU/OK** to create the multiple exposure, or press the selector left to return to Step 3 and retake the second shot.

SP SCENE POSITION

The camera offers a choice of “scenes,” each adapted to particular shooting conditions or a specific type of subject. Use the  **SCENE POSITION** option to choose the scene assigned to the **SP** position on the mode dial.



Scene	Description
 PORTRAIT	Choose for portraits.
 PORTRAIT ENHANCER	Choose for a smooth skin effect when shooting portraits.
 LANDSCAPE	Choose for daylight shots of buildings and landscapes.
 SPORT	Choose when photographing moving subjects.
 NIGHT	Choose this mode for poorly lit twilight or night scenes.
 NIGHT (TRIPOD)	Choose this mode for slow shutter speeds when shooting at night.
 FIREWORKS	Slow shutter speeds are used to capture the expanding burst of light from a firework.
 SUNSET	Choose this mode to record the vivid colors in sunrises and sunsets.
 SNOW	Choose for crisp, clear shots that capture the brightness of scenes dominated by shining white snow.

Scene	Description
 BEACH	Choose for crisp, clear shots that capture the brightness of sunlit beaches.
 UNDERWATER	Reduces the blue cast typically associated with underwater lighting.
 PARTY	Capture indoor background lighting under low-light conditions.
 FLOWER	Choose for vivid close-ups of flowers.
 TEXT	Take clear pictures of text or drawings in print.

M MANUAL

In this mode, you choose both shutter speed and aperture. If desired, exposure can be altered from the value suggested by the camera.

Rotate the command dial to set the shutter speed or aperture. Press the selector up () to change the setting item between shutter speed and aperture.

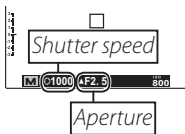

- ⓘ Noise in the form of randomly-spaced bright pixels may occur in long exposures.
- ⓘ The shutter speed is restricted depending on the ISO setting.
- ⓘ If the shutter speed is displayed in red at the selected aperture, photos will be taken without the selected shutter speed.

The Exposure Indicator

The amount the picture will be under- or over-exposed at current settings is shown by the exposure indicator.



A APERTURE PRIORITY AE

You choose the aperture using the command dial, while the camera adjusts shutter speed for optimal exposure.



- ❗ If the correct exposure can not be achieved at the selected aperture, shutter speed will be displayed in red. Adjust aperture until the correct exposure is achieved. If the subject is outside the metering range of the camera, the shutter speed display will show "----". Press the shutter button halfway to measure exposure again.

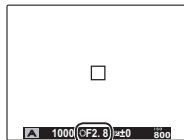

Aperture

S SHUTTER PRIORITY AE

You choose the shutter speed using the command dial, while the camera adjusts aperture for optimal exposure.



- ❗ If the correct exposure can not be achieved at the selected shutter speed, aperture will be displayed in red. Adjust shutter speed until the correct exposure is achieved. If the subject is outside the metering range of the camera, the aperture display will show "F---". Press the shutter button halfway to measure exposure again.
- ❗ If the shutter speed is displayed in red at the selected aperture, photos will be taken without the selected shutter speed.

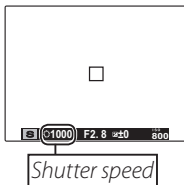

P PROGRAM AE

The camera sets exposure automatically.



- ⓘ If the subject is outside the metering range of the camera, the shutter speed and aperture displays will show “---”. Press the shutter button halfway to measure exposure again.

Program Shift



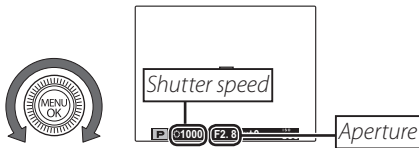



















Rotate the command dial to choose the desired combination of shutter speed and aperture. The default values can be restored by raising the flash or turning the camera off. To use program shift, turn the flash off. Furthermore, an option other than **AUTO** must be selected for **D-Range** **DYNAMIC RANGE** and **ISO** **ISO**.



C CUSTOM MODE

In **P**, **S**, **A**, and **M** modes, the  **CUSTOM SET** option in the shooting menu (📖 102) can be used to save current camera and menu settings. These settings are recalled whenever the mode dial is rotated to **C** (custom mode).



Menu/setting	Settings saved
Shooting menu	ISO ISO,  IMAGE SIZE ,  IMAGE QUALITY ,  DYNAMIC RANGE ,  FILM SIMULATION ,  COLOR ,  SHARPNESS ,  HIGHLIGHT TONE ,  SHADOW TONE ,  NOISE REDUCTION ,  FACE DETECTION ,  AF MODE ,  FOCUS MODE ,  FLASH COMPENSATION ,  PHOTOMETRY ,  WHITE BALANCE ,  CONTINUOUS ,  MOVIE SET-UP
Setup menu	 AF ILLUMINATOR ,  INTELLIGENT DIGITAL ZOOM
Other	Macro mode () , flash mode () , shutter speed, aperture, monitor display options (DISP/BACK), exposure compensation ()

ⓘ Once the camera is turned off,  **INTELLIGENT DIGITAL ZOOM** is deactivated.

Focus Lock

To compose photographs with off-center subjects:

1 Focus: Position the subject in the focus frame and press the shutter button halfway to lock focus and exposure. Focus and exposure will remain locked while the shutter button is pressed halfway (AF/AE lock).



2 Recompose: Keep the button pressed halfway.

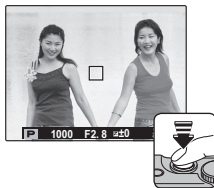

3 Shoot: Press the button all the way down.



◆ This function is available when **AF-S SINGLE AF** is selected for **[L] FOCUS MODE** (📖 57).

 **Autofocus**

Although the camera boasts a high-precision autofocus system, it may be unable to focus on the subjects listed below. If the camera is unable to focus, focus on another subject at the same distance and use focus lock to recompose the photograph.

- Very shiny subjects such as mirrors or car bodies.
- Fast-moving subjects.
- Subjects photographed through a window or other reflective object.
- Dark subjects and subjects that absorb rather than reflect light, such as hair or fur.
- Insubstantial subjects, such as smoke or flame.
- Subjects that show little contrast with the background (for example, subjects in clothing that is the same color as the background).
- Subjects positioned in front of or behind a high-contrast object that is also in the focus frame (for example, a subject photographed against a backdrop of highly contrasting elements).

Exposure Compensation

To adjust exposure compensation when photographing very bright, very dark, or high-contrast subjects, press the selector up () . Press the selector up or down or use the command dial to choose an exposure compensation value and then press **MENU/OK**.

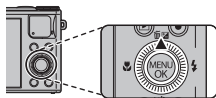

*Choose positive (+) values
to increase exposure*





*Choose negative (-) values
to reduce exposure*



- ❖ Exposure compensation is not reset when the camera is turned off; to restore normal exposure control, choose a value of ± 0 .
- ❖ Turn the flash off when using exposure compensation.

Macro Mode (Close-ups)

For close-ups, press the selector left () and select .
Use the zoom control to compose pictures ( 23).

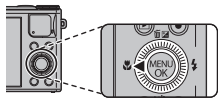

To exit macro mode, press the selector left () and select **OFF**.

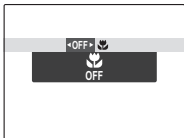

- ◆ Use of a tripod is recommended to prevent blur caused by camera shake.
- ◆ The shadow cast by the lens may appear in photographs taken with the flash at very short ranges. Zoom out or increase the distance to the subject.

⚡ Using the Flash (Super-Intelligent Flash)

When the flash is used, the camera's *Super-Intelligent Flash* system instantly analyzes the scene based on such factors as the brightness of the subject, its position in the frame, and its distance from the camera. Flash output and sensitivity are adjusted to ensure that the main subject is correctly exposed while preserving the effects of ambient background lighting, even in dimly-lit indoor scenes. Use the flash when lighting is poor, for example when shooting at night or indoors under low light.

- 1 Slide the flash pop-up switch to raise the flash.

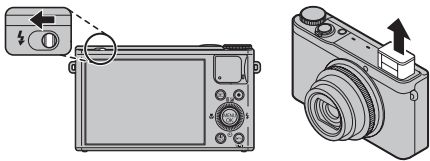

2 Press the selector right (⚡) and choose from the following flash modes:

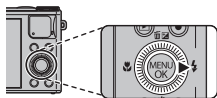

Option	Description
AUTO/	The flash fires when required. Recommended in most situations.
⚡/	The flash fires whenever a picture is taken. Use for backlit subjects or for natural coloration when shooting in bright light.
/	Capture both the main subject and the background under low light (note that brightly lit scenes may be overexposed).



* icon indicates that Intelligent Face Detection and red-eye removal are on and will be used to minimize “red-eye” caused by the flash reflecting from the retinas of portrait subjects.

- ❖ Lower the flash where flash photography is prohibited or to capture natural lighting under dim light. We also recommend that you lower the flash when the camera is off.
- ❖ If the flash will fire, will be displayed when the shutter button is pressed halfway. At slow shutter speeds, will appear in the display to warn that pictures may be blurred; use of a tripod is recommended.
- ❖ The flash may fire several times with each shot. Do not move the camera until shooting is complete.
- ❖ The flash may cause vignetting.

Using the Self-Timer

To use the self-timer, press the selector down (⏻) and choose from the following options:

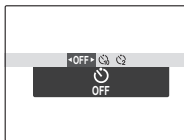
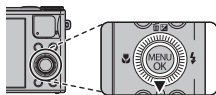



Option	Description
⏻ (OFF)	Self-timer off.
⏻ (10 SEC)	The shutter is released ten seconds after the shutter button is pressed. Use for self-portraits. The self-timer lamp on the front of the camera lights when the timer starts and begins to blink shortly before the photo is taken.
⏻ (2 SEC)	The shutter is released two seconds after the shutter button is pressed. Use to reduce blur caused by the camera moving when the shutter button is pressed. The self-timer lamp will blink as the timer counts down.

The E-Fn Button

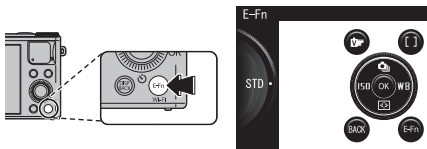
Press the **E-Fn** button to use the **E-Fn** (extended function) menu.





The each role played by the  button, the  button and the selector up, down, left and right can be used in the **E-Fn** menu. Also, you can change the function assigned to the control ring.

◆ Press the **E-Fn** button again to return to shooting mode.

■ Using the E-Fn BUTTON CUSTOM SETTING Menu

The following options are available:

ISO (📖 90)/**IMAGE SIZE** (📖 92)/**IMAGE QUALITY** (📖 93)/
DYNAMIC RANGE (📖 93)/**FILM SIMULATION** (📖 94)/
WHITE BALANCE (📖 95)/**CONTINUOUS** (📖 52)/**PHOTOMETRY** (📖 98)/
AF MODE (📖 99)/**FOCUS MODE** (📖 57)/**FOCUS AREA** (📖 59)/
FACE DETECTION (📖 60)/**INTELLIGENT DIGITAL ZOOM** (📖 120)/
WIRELESS COMMUNICATION (📖 71)

1 Select  **E-Fn** **BUTTON CUSTOM SETTING** in the shooting menu. The  **E-Fn** **BUTTON CUSTOM SETTING** menu is displayed.

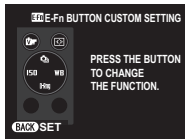

- 2 Press the button to adjust.
- 3 Highlight items and press the selector up or down to view options, then highlight an option and press **MENU/OK**.

■ Changing functions assigned to the control ring

The following options are available:

DEFAULT (📖 4)/**EXPOSURE** (📖 44)/**ISO** (📖 90)/**WHITE BALANCE** (📖 95)/**FILM SIMULATION** (📖 94)/**CONTINUOUS** (📖 52)/**ZOOM** (📖 23)

- 1 Press the **E-Fn** button.
- 2 Rotate the control ring. The **CONTROL RING SETTING** menu is displayed.
- 3 Rotate the control ring to highlight an option.
- 4 Press **MENU/OK**.

The options of the control ring except when the default

The follows are options and operations except when the control ring is set to **DEFAULT**.

For auto focus

Options \ Mode	SR+ ¹	📷	P	A	S	M	Adv.	Filter	SP	Movie
EXPOSURE			✓	✓	✓		✓	✓	✓ ²	✓
ISO			✓	✓	✓	✓	*1			
WHITE BALANCE			✓	✓	✓	✓				
FILM SIMULATION	✓	✓	✓	✓	✓	✓	✓			
CONTINUOUS	✓	✓	✓	✓	✓	✓			✓ ²	
ZOOM	✓	✓	✓	✓	✓	✓	✓	✓	✓	✓

For manual focus³

Options \ Mode	SR+ ¹	📷	P	A	S	M	Adv. ⁴	Filter	SP	Movie
EXPOSURE		MF	MF	MF	MF	MF	✓	✓	MF ⁵	MF
ISO		MF	MF	MF	MF	MF			MF ⁶	MF
WHITE BALANCE		MF	MF	MF	MF	MF			MF ⁶	MF
FILM SIMULATION	✓	MF	MF	MF	MF	MF	✓		MF ⁶	MF
CONTINUOUS	✓	MF	MF	MF	MF	MF			MF ⁵	MF
ZOOM	✓	MF	MF	MF	MF	MF	✓	✓	MF ⁵	MF

*1 Available for 📷.

*2 Not available for 📷.

*3 "MF" shows that the control ring is used to focus manually when **MF** is selected for **FOCUS MODE** (57).

*4 All options turn to be MF for 📷.

*5 Not MF but assigned options are available for 📷.







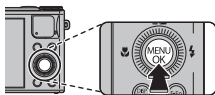

*6 Neither MF nor assigned options are available for 📷.





📷 You can also assign functions to the control ring by selecting **CONTROL RING SETTING** from the shooting menu.

Continuous Shooting

To capture motion in a series of pictures, press **MENU/OK**, select  **CONTINUOUS** in the shooting menu, and choose from the options listed in this section.



Option	
 STILL IMAGE	—
 TOP <i>n</i>	53
 BEST FRAME CAPTURE	53
 AE BKT	55
 ISO BKT	55
 FILM SIMULATION BKT	55
 DYNAMIC RANGE BKT	56

- ❖ The flash turns off automatically. The previously selected flash mode is restored when  is selected for  **CONTINUOUS**.
- ❖ Frame rate may vary with shutter speed or scene.
- ❖ Focus and exposure are determined by the first frame in each series. If you want to have the camera adjust focus and exposure automatically during continuous shooting, select  in  **FOCUS MODE** and select  for a frame rate.
- ❖ The number of pictures that can be taken in a single burst varies with the scene and camera settings. The number of pictures that can be recorded depends on the memory available.

TOP n

The camera takes photographs while the shutter button is pressed. To choose the frame rate:

- 1 Press the selector left or right to choose a frame rate and press **MENU/OK** to select and return to shooting mode.

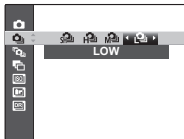

BEST FRAME CAPTURE

The camera takes a series of pictures, starting before and ending after the shutter button is pressed.

- 1 Press the selector right when the camera is in shooting mode.
- 2 Highlight the current frame rate and press the selector right, then press selector up or down to choose a new value and press **MENU/OK** to select.
 - ① Some frame rates may reduce the number of shots available.

- 3 Highlight the number of shots and press the selector right. Press the selector left or right to choose how the shots are distributed (the number on the left is taken *before* and the number on the right *after* the shutter button is pressed). Press **MENU/OK** when settings are complete and press **DISP/BACK** to return to shooting mode.

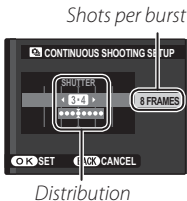

- 4 Take photographs. The camera begins recording while the shutter button is pressed halfway, and completes the burst when the shutter button is pressed all the way down. The illustration shows a burst of eight shots, three before the shutter button is pressed and four after.

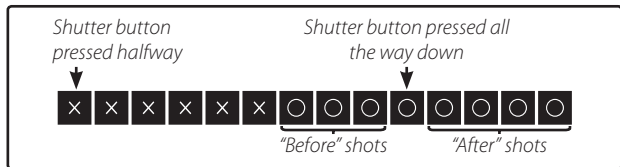

- ① If the shutter button is pressed all the way down before the number of frames selected for the "before" portion is recorded, the remaining frames will be taken after the shutter button is pressed all the way down.
- ① If the shutter button is pressed halfway for an extended period, the camera may record the burst before the shutter button is pressed all the way down.



■ AE BKT

Each time the shutter button is pressed, the camera takes three shots: one using the metered value for exposure, the second overexposed by the amount selected for the selector left or right, and the third underexposed by the same amount (the camera may not be able to use the selected bracketing increment if the amount of over- or under- exposure exceeds the limits of the exposure metering system).







■ ISO BKT

Press the selector left or right to highlight a bracketing amount. Each time the shutter is released, the camera will take a picture at the current sensitivity ( 90) and process it to create two additional copies, one with sensitivity raised and the other with sensitivity lowered by the selected amount (regardless of the amount selected, sensitivity will not exceed ISO 1600 or fall below ISO 200).

■ FILM SIMULATION BKT

Each time the shutter is released, the camera takes one shot and processes it to create copies with the film simulation settings selected for  **FILM SIMULATION BKT** in the shooting menu ( 94).

DYNAMIC RANGE BKT

Each time the shutter button is pressed, the camera takes three shots at different  **DYNAMIC RANGE** settings (📖 93):  **100%** for the first,  **200%** for the second, and  **400%** for the third ( **ISO** can not exceed 3200; values less than 400 are not available when  is selected for  **IMAGE SIZE**).

Focus Mode

To choose how the camera focuses, press **MENU/OK** to display the shooting menu and choose from the **FOCUS MODE** options.

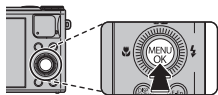

The following options are available:

Mode	Description
MF MANUAL FOCUS	Focus manually using the control ring. Rotate the control ring left to reduce the focus distance, right to increase. Choose for manual control of focus or in situations in which the camera is unable to focus using autofocus (42). Intelligent Face Detection turns off automatically.
AF-S SINGLE AF	Focus locks while the shutter button is pressed halfway. Choose for stationary subjects.
AF-C CONTINUOUS AF	The camera continually adjusts focus to reflect changes in the distance to the subject when the shutter button is pressed halfway (note that this increases the drain on the battery). Choose for moving subjects.

■ Focus indicator

You can check focus with the focus indicator.

Focus indicator	Description
()	The camera is adjusting focus.
● (glows green)	The camera is able to focus and the focus position is fixed when AF-S is selected.
● (glows green)	The camera is able to focus when AF-C is selected. ◆ The focus position changes to reflect changes in the distance to the subject.
○ (blinks white)	The camera is unable to focus.

◆ **MF** is displayed when **MF** is selected for **[L] FOCUS MODE**.

Manual Focus

- Use the **CONTROL RING** option in the setup menu (📖 115) to reverse the direction of rotation of the control ring.
- The camera will not focus if the control ring is rotated past infinity.
- To focus using autofocus, press the selector left. This can be used to quickly focus on a chosen subject in manual focus mode.
- If a face is detected when **FACE** is selected, a **FACE** icon will be displayed and the camera will continuously adjust focus to maintain focus on the face.

MF FOCUS CHECK

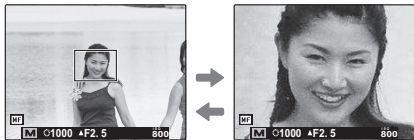

If **ON** is selected for **MF FOCUS CHECK** in the setup menu (📖 115), rotating the control ring magnifies the view in the LCD monitor.

- The focus check area can be scrolled (📖 59).



The outlines with the most contrast at the current focus distance can be viewed by selecting **FOCUS PEAK HIGHLIGHT** for **MF ASSIST** (📖 100).

Focus Frame Selection

When  **AREA** is selected for  **AF MODE** in the shooting menu, focus position can be changed. Press **MENU/OK** to select  **FOCUS AREA** in the shooting menu and then press the selector up, down, left or right. The setting takes effect when you press the **MENU/OK** button again.

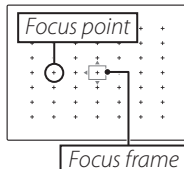

When framing a picture in the LCD monitor, you can choose the size of the focus frame. Press **MENU/OK**, select  **FOCUS AREA** in the shooting menu and then rotate the command dial. The frame size can be reduced up to 50% or enlarged up to 150%. The setting takes effect when you press the **MENU/OK** again.

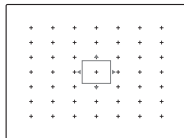

Intelligent Face Detection

Intelligent Face Detection sets focus and exposure for human faces anywhere in the frame, preventing the camera from focusing on the background in group portraits. Choose for shots that emphasize portrait subjects.

To use Intelligent Face Detection, press **MENU/OK** to display the shooting menu and select **ON** for  **FACE DETECTION**. Faces can be detected with the camera in vertical or horizontal orientation; if a face is detected, it will be indicated by a green border. If there is more than one face in the frame, the camera will select the face closest to the center; other faces are indicated by white borders.

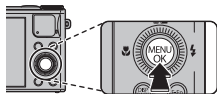

- ❶ In some modes, the camera may set exposure for the frame as a whole rather than the portrait subject.
- ❷ If the subject moves as the shutter button is pressed, their face may not be in the area indicated by the green border when the picture is taken.

More on Playback

Playback Options

To view the most recent picture in the LCD monitor, press the  button.

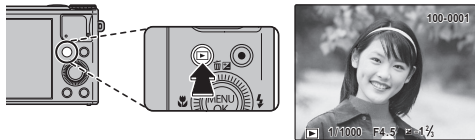

Press the selector right to view pictures in the order recorded, left to view pictures in reverse order. Keep the selector pressed to scroll rapidly to the desired frame.

❖ Pictures taken using other cameras are indicated by a  ("gift image") icon during playback.

Continuous Shooting

In the case of pictures taken in continuous shooting mode, only the first frame of each series will be displayed. Press the selector down to view the other pictures in the series.

★ Favorites: Rating Pictures

To rate the picture currently displayed in full-frame playback, press **DISP/BACK** and press the selector up and down to select from zero to five stars.

Playback Zoom

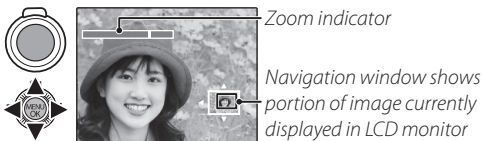

Select **[Z]** to zoom in on pictures displayed in single-frame playback; select **[Z]** to zoom out. When the picture is zoomed in, the selector can be used to view areas of the image not currently visible in the display.



Press **DISP/BACK** to exit zoom.

- ◆ If the pictures before or after the current picture are the same size as the current picture, you can rotate the command dial to view the other pictures without changing the zoom ratio. This option is not available if the pictures are not the same size as the current picture.
- ◆ The maximum zoom ratio varies with image size. Playback zoom is not available with cropped or resized copies saved at a size of **640** or smaller.

Multi-Frame Playback

To display multiple images, select  when a picture is shown full-frame in the LCD monitor. Select  to increase the number of images displayed from two to nine or one hundred,  to view fewer images.

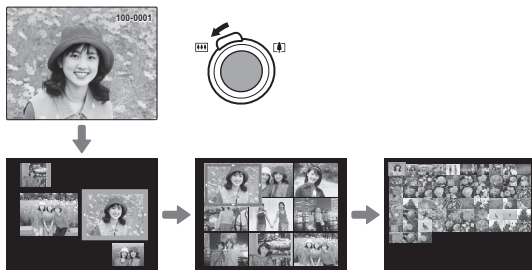

When two or more images are displayed, use the selector to highlight images and press **MENU/OK** to view the highlighted image full frame. In the nine- and hundred-frame displays, use the selector to view more pictures.

Deleting Pictures

To delete individual pictures, multiple selected pictures, or all pictures, press the selector up () and choose from the options below. *Note that deleted pictures can not be recovered. Copy important pictures to a computer or other storage device before proceeding.*

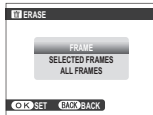

Option	Description
FRAME	Press the selector left or right to scroll through pictures and press MENU/OK to delete the current picture (a confirmation dialog is not displayed).
SELECTED FRAMES	Highlight pictures and press MENU/OK to select or deselect (pictures in photobooks or print orders are shown by ) . When the operation is complete, press DISP/BACK to display a confirmation dialog, then highlight OK and press MENU/OK to delete the selected pictures.
ALL FRAMES	A confirmation dialog will be displayed; highlight OK and press MENU/OK to delete all unprotected pictures (if a memory card is inserted, only the pictures on the memory card will be affected; the pictures in internal memory are only deleted if no memory card is inserted). Pressing DISP/BACK cancels deletion; note that any pictures deleted before the button was pressed can not be recovered.







- ❖ Protected pictures can not be deleted. Remove protection from any pictures you wish to delete ( 109).
- ❖ Pictures can also be deleted by  **ERASE** from playback menu.
- ❖ If a message appears stating that the selected images are part of a DPOF print order, press **MENU/OK** to delete the pictures.

Image Search

Search for pictures.

- 1 Select  **IMAGE SEARCH** in the playback menu, highlight one of the following search criteria, and press **MENU/OK**:
 - **BY DATE**: Search by date.
 - **BY FACE**: Search for faces from the face recognition database.
 - **BY ★ FAVORITES**: Search by rating.
 - **BY SCENE**: Search by scene.
 - **BY TYPE OF DATA**: Find all still pictures or all movies.
 - **BY UPLOAD MARK**: Find all pictures selected for upload to a specified destination.
- 2 Select a search condition. Only pictures that match the search condition will be displayed. To delete or protect selected pictures or to view the search results in a slide show, press **MENU/OK** and choose  **ERASE** (📖 64),  **PROTECT** (📖 109), or  **SLIDE SHOW** (📖 106).

PhotoBook Assist

Create books from your favorite photos.

Creating a PhotoBook

1 Select **NEW BOOK** for  **PHOTOBOOK ASSIST** in the playback menu and choose from the following options:

- **SELECT FROM ALL:** Choose from all available pictures.
- **SELECT BY IMAGE SEARCH:** Choose from pictures matching selected search conditions ( 65).

◆ Neither photographs  or smaller nor movies can be selected for photobooks.

2 Scroll through the images and press the selector up to select or deselect. To display the current image on the cover, press the selector down. Press **MENU/OK** to exit when the book is complete.

◆ The first picture selected becomes the cover image. Press the selector down to select a different image for the cover.

3 Select **COMPLETE PHOTOBOOK** (to select all photos or all photos matching the specified search conditions for the book, choose **SELECT ALL**). The new book will be added to the list in the photobook assist menu.

① Books can contain up to 300 pictures.

① Books that contain no photos are automatically deleted.

Viewing Photobooks

Highlight a book in the photobook assist menu and press **MENU/OK** to display the book, then press the selector left or right to scroll through the pictures.

Editing and Deleting Photobooks

Display the photobook and press **MENU/OK**. The following options will be displayed; select the desired option and follow the on-screen instructions.

- **EDIT:** Edit the book as described in “Creating a PhotoBook” (📖 66).
- **ERASE:** Delete the book.

Photobooks

Photobooks can be copied to a computer using the supplied MyFinePix Studio software.

Viewing Panoramas

If you press the selector down when a panorama is displayed full frame, the camera will play back the picture from left to right or from bottom to top. To pause playback, press the selector down; press the selector down again to resume. To exit to full-frame playback, press the selector up while panorama playback is in progress. Once displayed in full-frame playback, panoramas can be zoomed in or out using the zoom control or deleted by pressing the selector up (🗑️).

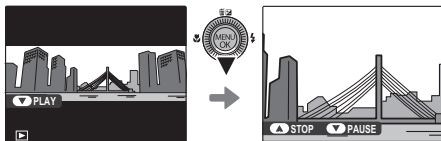

- 📺 panoramas play back in an endless loop (📖 32); the playback direction can be controlled by pressing the selector left or right. The camera will not turn off automatically while playback is in progress (📖 118).

Viewing Photo Information

Photo information can be viewed by pressing **DISP/BACK** to cycle through indicators (📖 7) until the following display appears:

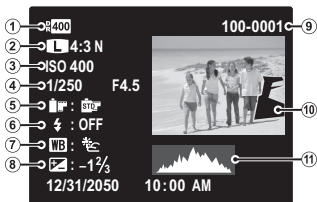

- ① Dynamic range
- ② Image size and quality
- ③ Sensitivity
- ④ Shutter speed/aperture
- ⑤ Film simulation
- ⑥ Flash mode
- ⑦ White balance
- ⑧ Exposure compensation
- ⑨ Frame number
- ⑩ Picture (overexposed areas blink on and off)
- ⑪ Histogram

Additional photo information

Additional photo information can be viewed by rotating the control ring. Rotate the control ring to cycle the display.

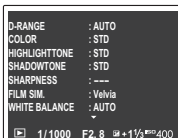

👉 The active focus point is shown by a "+" icon.

Zooming in on the Focus Point

Press the selector down to zoom in on the focus point. Press **DISP/BACK** or **MENU/OK** to return to full-frame playback.

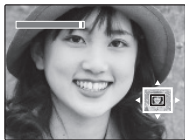

Wireless Networks

Using Wireless Networks

You can connect the camera with a smartphone or a PC. For information on using wireless networks, visit <http://app.fujifilm-dsc.com/>.

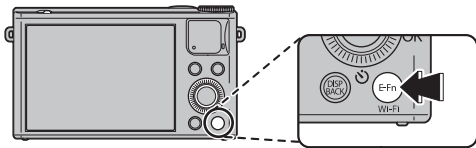

Connecting with smartphones

Connect to smartphones via a wireless network. Press the **Wi-Fi** button during playback to upload pictures to smartphones or remotely browse the pictures on the camera and select images for download. You can also download location data from smartphones. Before proceeding, download the free FUJIFILM Camera Application app and install it on your smartphone. This option can also be enabled by  **WIRELESS COMMUNICATION** from playback menu. You can also use the wireless communication option in the shooting mode when **WIRELESS COMMUNICATION** is assigned in the **E-Fn** menu.

Saving Pictures to a Computer

Press and hold the **Wi-Fi** button during playback to save pictures to a computer over a wireless network. Before proceeding, install the free FUJIFILM PC AutoSave application to the destination computer and adjust settings as desired. This option can also be enabled by  **PC AUTO SAVE** from playback menu.

Movies





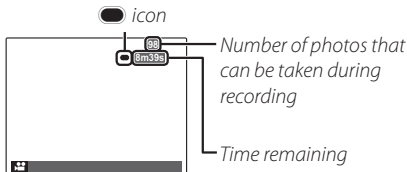



Recording Movies

Press  to shoot a movie. During recording, the following indicators will be displayed and sound will be recorded via the built-in microphone (be careful not to cover the microphone during recording).



To end recording, press  again. Recording ends automatically when the movie reaches maximum length or memory is full. For information on the maximum footage that can be recorded, see page 138.

Automatic Scene Selection



In  mode, the camera selects the scene according to shooting conditions and the type of subject:  (portraits),  (poorly-lit landscapes),  (poorly-lit portraits),  (landscapes),  (close-ups),  (backlit portraits), or  (other subjects).



Taking Photographs During Recording

Press the shutter button to take a photograph during recording.









- ❖ The method used to record photographs can be selected using the  **MOVIE SET-UP > STILL SHOOTING IN MOVIE** option (📖 102).
- ❖ The photo is saved separately from the movie and does not appear as part of the movie.
- ⓘ Photos can not be taken while a high-speed movie is being recorded.
- ⓘ The number of photos that can be taken is limited.

- ❖ Zoom can be adjusted while recording is in progress.
- ❖ If the subject is poorly lit, the AF-assist lamp may light to assist the focus operation. To turn the AF-assist lamp off, select **OFF** for  **AF ILLUMINATOR** (📖 120).
- ❖ When  **MANUAL FOCUS** is set for **MOVIE FOCUS MODE**, you can focus manually during movie recording (📖 102).
- ❖ White balance is adjusted automatically throughout recording. The color and brightness of the image may vary from that displayed before recording begins.
- ❖ Sounds made by the camera may be recorded.
- ⓘ The indicator lamp lights while movies are being recorded. Do not open the battery chamber during shooting or while the indicator lamp is lit. Failure to observe this precaution could prevent the movie from being played back.
- ⓘ Vertical or horizontal streaks may appear in movies containing very bright subjects. This is normal and does not indicate a malfunction.

- ⓘ The temperature of the camera may rise if it is used to record movies for an extended period or if the ambient temperature is high. This is normal and does not indicate a malfunction.
- ⓘ The mode selected may vary with shooting conditions.

Movie Frame Size

Before recording, select a frame size using the  **MOVIE SET-UP > MOVIE MODE** option.

Option	Description
 1920×1080 (60 fps)	Full HD (High Definition).
 1920×1080 (30 fps)	
 1280×720 (60 fps)	High Definition.
 1280×720 (30 fps)	
 640×480	Standard definition.
 640×480 (80 fps)	High speed movie. Sound is not recorded, and focus, exposure, and white balance are not adjusted automatically. Black bands appear at the top and bottom of movies recorded at  320×112 .
 320×240 (150 fps)	
 320×112 (250 fps)	

Viewing Movies

During playback, movies are displayed in the LCD monitor as shown at right. The following operations can be performed while a movie is displayed:

Option	Description
Start/pause playback	Press the selector down to start playback. Press again to pause. While playback is paused, you can press the selector left or right to rewind or advance one frame at a time.
End playback/delete	Press the selector up to end playback.
Adjust speed	Press the selector left or right to adjust playback speed during playback.
Adjust volume	Press MENU/OK to pause playback and display volume controls. Press the selector up or down to adjust the volume and press MENU/OK to exit. Volume can also be adjusted using the ▶ SOUND SET-UP > PLAYBACK VOLUME option (📖 116).

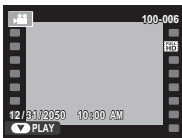

▶ Playback Speed

Press the selector left or right to adjust playback speed. Speed is shown by the number of arrows (▶ or ◀).

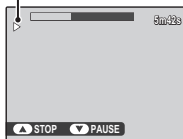

ⓘ Do not cover the speaker during playback.

Connections

Viewing Pictures on High-Definition TVs

The camera can be connected to High-Definition (HD) devices using an HDMI cable (available separately from third-party sources).

- 1 Turn the camera off and connect the HDMI cable as shown below.

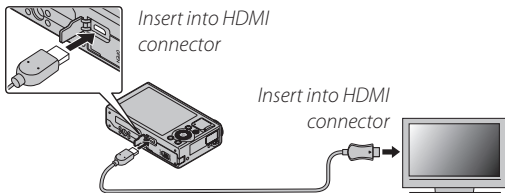

- ① Use an HDMI cable no more than 1.5 m (4.9 ft.) long.
 - ◆ When connecting cables, be sure the connectors are fully inserted.
- 2 Tune the television to the HDMI input channel. See the documentation supplied with the television for details.
- 3 Press the  button for about a second to turn the camera on. The camera monitor turns off and pictures and movies are played back on the TV. Note that the camera volume controls have no effect on sounds played on the TV; use the television volume controls to adjust the volume.
- ◆ Some televisions may briefly display a black screen when movie playback begins.

Printing Pictures via USB

If the printer supports PictBridge, the camera can be connected directly to the printer as shown below and pictures can be printed without first being copied to a computer. Note that depending on the printer, not all the functions described below may be supported.



- 1 Connect the supplied USB cable as shown and turn the printer on.

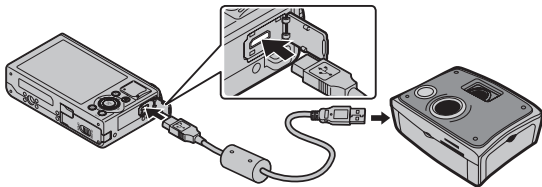

- 2 Turn the camera on.
- 3 Press the selector left or right to display a picture you wish to print.
- 4 Press the selector up or down to choose the number of copies (up to 99).
- 5 Repeat steps 3–4 to select additional pictures. Press **MENU/OK** to display a confirmation dialog when settings are complete.

6 Press **MENU/OK** to start printing. Printing can be interrupted by pressing **DISP/BACK**, but note that some printers may not respond immediately. If the printer stops before printing is complete, turn the camera off and then on again.

7 After confirming that **PRINTING** has cleared from the camera display, turn the camera off and disconnect the USB cable.

- ◆ Pictures can be printed from internal memory or a memory card that has been formatted in the camera.
- ◆ If no pictures are selected, the camera will print one copy of the current picture.
- ◆ Page size, print quality, and border selections are made using the printer.

Printing the Date of Recording

To print the date of recording on pictures, press **DISP/BACK** in the PictBridge display and select **PRINT WITH DATE**  in the PictBridge menu (to print pictures without the date of recording, select **PRINT WITHOUT DATE**). Some printers do not support date printing. See the printer manual for details.



Printing the DPOF Print Order

The  **PRINT ORDER (DPOF)** option can be used to create a digital “print order” for PictBridge-compatible printers (📖 77) or devices that support DPOF.

DPOF

DPOF (Digital Print Order Format) is a standard that allows pictures to be printed from “print orders” stored in internal memory or on a memory card. The information in the order includes the pictures to be printed and the number of copies of each picture.



- 1 Select playback mode and press **MENU/OK** to display the playback menu.
- 2 Highlight  **PRINT ORDER (DPOF)** and press **MENU/OK**.
- 3 Highlight one of the following options and press **MENU/OK**:
 - **WITH DATE** : Print the date of recording on pictures.
 - **WITHOUT DATE**: Do not print the date of recording on pictures.

 Some printers do not support date printing. See the printer manual for details.
- 4 Press the selector left or right to display a picture you wish to add to or remove from the print order.

- 5** Press the selector up or down to choose the number of copies (up to 99). To remove a picture from the print order, press the selector down until the number of copies is zero.
- 6** Repeat Steps 4–5 to complete the print order and press **MENU/OK** when settings are complete.
- 7** A confirmation dialog will be displayed. Press **MENU/OK** to save the print order.

 - ◆ Remove the memory card to create or modify a print order for the pictures in internal memory.
 - ◆ Print orders can contain a maximum of 999 pictures.
 - ◆ If a memory card is inserted containing a print order created by another camera, a message will be displayed. Create a new print order as described above.

Viewing Pictures on a Computer

The supplied software can be used to copy pictures to a computer, where they can be stored, viewed, organized, and printed. Before proceeding, install the software as described below. *Do not connect the camera to the computer until installation is complete.*

Windows: Installing MyFinePix Studio

1 Confirm that the computer meets the following system requirements:

	Windows 8/Windows 7 (SP 1)/ Windows Vista (SP 2)¹	Windows XP (SP 3)¹
CPU	3 GHz Pentium 4 or better (2.4GHz Core 2 Duo or better) ²	2GHz Pentium 4 or better (2.4GHz Core 2 Duo or better) ²
RAM	1 GB or more	512 MB or more (1 GB or more) ²
Free disk space	2 GB or more	
GPU	Supports DirectX 9 or later (recommended)	Supports DirectX 7 or later (required; performance not guaranteed with other GPUs)
Video	1,024×768 pixels or more with 24-bit color or better	
Other	<ul style="list-style-type: none">• Built-in USB port recommended. Operation is not guaranteed with other USB ports.• .NET Framework 3.5 Service Pack 1 required when uploading images or using Map Viewer.• Internet connection (broadband recommended) required to install .NET Framework (if necessary), to use auto update feature, and when performing such tasks as sharing pictures on-line or via e-mail.	

1 Other versions of Windows are not supported. Only pre-installed operating systems are supported; operation is not guaranteed on home-built computers or computers that have been upgraded from earlier versions of Windows.

2 Recommended when displaying HD movies.

- 2 Start the computer. Log in to an account with administrator privileges before proceeding.
- 3 Exit any applications that may be running and insert the installer CD in a CD-ROM drive.

 **Windows 8/Windows 7/Windows Vista**

If an AutoPlay dialog is displayed, click **SETUP.EXE**. A “User Account Control” dialog will then be displayed; click **Yes** (Windows 8/Windows 7) or **Allow** (Windows Vista).

The installer will start automatically; click **Install MyFinePix Studio** and follow the on-screen instructions to install MyFinePix Studio and RAW FILE CONVERTER.

 **If the Installer Does Not Start Automatically**

If the installer does not start automatically, select **Computer** or **My Computer** from the Start menu, then double-click the **FINEPIX** CD icon to open the FINEPIX CD window and double-click **setup** or **SETUP.EXE**.

 **If the Installer Does Not Start Automatically (Windows 8)**

- 1** Select **Desktop** on the Start screen.
- 2** Select **File Explorer** on the taskbar.
- 3** Select **Computer** in the navigation pane.
- 4** Double-click the drive icon inserting the **FINEPIX** CD and follow the on-screen instructions to install.

- 4** If prompted to install Windows Media Player or DirectX, follow the on-screen instructions to complete installation.
- 5** Remove the installer CD from the CD-ROM drive when installation is complete. Store the installer CD in a dry location out of direct sunlight in case you need to re-install the software.

Installation is now complete. Proceed to “Connecting the Camera” (📖 86).

Macintosh: Installing RAW FILE CONVERTER

RAW FILE CONVERTER is used to view RAW images on your computer.

- 1 Confirm that the computer meets the following system requirements:

CPU	Intel (Core 2 Duo or better)
OS	Pre-installed copies of Mac OS X version 10.6–10.8 (visit http://www.fujifilm.com/support/digital_cameras/compatibility/ for more information).
RAM	1 GB or more
Free disk space	A minimum of 200MB required for installation with 400MB available when RAW FILE CONVERTER is running
Video	1,024 × 768 pixels or more with 24-bit color or better

- 2 After starting the computer and quitting any applications that may be running, insert the installer CD in a CD-ROM drive and double-click **SILKYRFCEXInstaller**.
- 3 Enter an administrator name and password when prompted and click **OK**, then follow the on-screen instructions to install. Click **Exit** to quit the installer when installation is complete.

- 4 Remove the installer CD from the CD-ROM drive. Note that you may be unable to remove the CD if Safari is running; if necessary, quit Safari before removing the CD. Store the installer CD in a dry location out of direct sunlight in case you need to re-install the software.

Installation is now complete. Proceed to “Connecting the Camera” (📖 86).

Importing Pictures or Movies to Mac (Macintosh)

Use a standard application in Mac OS such as Image Capture to import pictures or movies to Mac.

Connecting the Camera

- 1** If the pictures you wish to copy are stored on a memory card, insert the card into the camera.
 - ◆ Windows users may require the Windows CD when starting the software for the first time.
 - Ⓢ Loss of power during transfer could result in loss of data or damage to internal memory or the memory card. Charge the battery before connecting the camera.
- 2** Turn the camera off and connect the supplied USB cable as shown, making sure the connectors are fully inserted. Connect the camera directly to the computer; do not use a USB hub or keyboard.

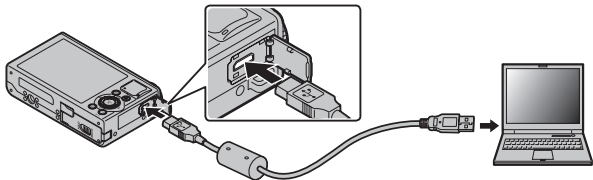

- Ⓢ The USB cable must be no more than 1.5 m (4.9 ft.) long and be suitable for data transfer.
- 3** Turn the camera on.
- 4** Upload pictures in MyFinePix Studio and follow the on-screen instructions to copy pictures to the computer. To exit without copying pictures, click **Cancel**.

For more information on using the supplied software, start the application and select the appropriate option from the **Help** menu.

- ① If a memory card containing a large number of images is inserted, there may be a delay before the software starts and you may be unable to import or save images. Use a memory card reader to transfer pictures.
- ① Make sure that the computer does not display a message stating that copying is in progress and that the indicator lamp is out before turning the camera off or disconnecting the USB cable (if the number of images copied is very large, the indicator lamp may remain lit after the message has cleared from the computer display). Failure to observe this precaution could result in loss of data or damage to internal memory or the memory card.
- ① Disconnect the camera before inserting or removing memory cards.
- ① In some cases, it may not be possible to access pictures saved to a network server using the supplied software in the same way as on a standalone computer.
- ① The user bears all applicable fees charged by the phone company or Internet service provider when using services that require an Internet connection.

Disconnecting the Camera

After confirming that the indicator lamp is out, turn the camera off and disconnect the USB cable.

Uninstalling the Supplied Software

Only uninstall the supplied software when it is no longer required or before beginning reinstallation. After quitting the software and disconnecting the camera, drag the “RAW FILE CONVERTER EX powered by SILKYPIX” folder from “Applications” into the Trash and select **Empty Trash** in the **Finder** menu (Macintosh), or open the control panel and use “Programs and Features” (Windows 8/Windows 7/Windows Vista) or “Add or Remove Programs” (Windows XP) to uninstall MyFinePix Studio. Under Windows, one or more confirmation dialogs may be displayed; read the contents carefully before clicking **OK**.

Menus

Using the Menus: Shooting Mode

Using the Shooting Menu

1 Display the shooting menu.

- 1.1 Press **MENU/OK** during shooting to display the shooting menu.

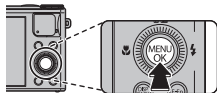

- 1.2 Press the selector left to highlight the current tab.

- 1.3 Press the selector up or down to highlight the tab containing the desired option.

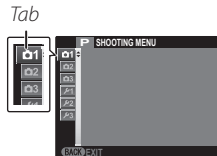

- 1.4 Press the selector right to place the cursor in the menu.

2 Adjust settings.

Highlight items and press the selector right to view options, then highlight an option and press **MENU/OK**. Press **DISP/BACK** to exit when settings are complete.



Shooting Menu Options

 **SCENE POSITION** (default: )

Choose a scene for **SP** mode ( 36).

 **ADVANCED FILTER** (default: )

Choose to take photos with filter effects ( 30).

 **Adv. MODE** (default: )

Choose an advanced shooting mode ( 30).

 **ISO** (default: **AUTO**)

Control the camera's sensitivity to light. Higher values can reduce blur; note, however, that mottling may appear in pictures taken at high sensitivities.



Option	Description
AUTO	Sensitivity is adjusted automatically in response to shooting conditions.
12800 / 6400 / 5000 / 4000 / 3200 / 2500 / 2000 / 1600 / 1250 / 1000 / 800 / 640 / 500 / 400 / 320 / 250 / 200 / 100	Sensitivity is set to the specified value, which is shown in the display.

ISO ISO (Continued)**(default: AUTO)****■ AUTO**

The following options are available when **AUTO** is selected:

Option	Default
DEFAULT SENSITIVITY	100
MAX. SENSITIVITY	800
MIN. SHUTTER SPEED	1/30

The camera automatically chooses a sensitivity between the default and maximum values. Sensitivity is only raised above the default value if the shutter speed required for optimal exposure would be slower than the value selected for **MIN. SHUTTER SPEED**.

- ❖ If the value selected for **DEFAULT SENSITIVITY** is higher than that selected for **MAX. SENSITIVITY**, **DEFAULT SENSITIVITY** will be set to the value selected for **MAX. SENSITIVITY**.
- ❖ The camera may select shutter speeds slower than **MIN. SHUTTER SPEED** if pictures would still be underexposed at the value selected for **MAX. SENSITIVITY**.

 **IMAGE SIZE**
(default: **L 4:3**)

Choose the image size and aspect ratio at which pictures are recorded. Large pictures can be printed at large sizes with no drop in quality, while small pictures require less memory, allowing more pictures to be recorded.

 **Size Versus Aspect Ratio**
Size

Option	Prints at sizes up to
L	34×25 cm (13.5×10 in.)
M	24×18 cm (9.5×7 in.)
S	17×13 cm (7×5 in.)

Aspect ratio

4:3: Pictures have the same proportions as the camera display.

3:2: Pictures have the same proportions as a frame of 35 mm film.

16:9: Suited for display on High Definition (HD) devices.

1:1: Pictures are square.





IMAGE QUALITY(default: **FINE**)

Choose a file format and compression ratio. Select **FINE** or **NORMAL** to record JPEG images, **RAW** to record RAW images, or **FINE+RAW** or **NORMAL+RAW** to record both JPEG and RAW images. **FINE** and **FINE+RAW** use lower JPEG compression ratios for higher-quality JPEG images, while **NORMAL** and **NORMAL+RAW** use higher JPEG compression ratios to increase the number of images that can be stored.

- 🔗 To convert RAW files for display on a computer, use the supplied RAW File Converter software.
- ⚠️ Crop, resize, and red-eye removal options are not available with RAW images during playback, while the maximum available zoom ratio is restricted.









DYNAMIC RANGE(default: **AUTO**)

Control contrast. Higher values are recommended for scenes that include both sunlight and deep shade or for increased contrast with such subjects as sunlight on water, brightly-lit autumn leaves, portraits taken against a blue sky, and white objects or people wearing white; note, however, that mottling may appear in pictures taken at higher values. If **AUTO** is selected, the camera will automatically select values between 100% and 400% in response to shooting conditions.

Option		Description
AUTO	 100 100%	 Increase contrast when shooting indoors or under overcast skies.
	 200 200%	
	 400 400%	

FILM SIMULATION(default: )









Simulate the effects of different types of film.

Option	Description
 (PROVIA/STANDARD)	Standard color reproduction. Suited to a wide range of subjects, from portraits to landscapes.
 (Velvia/VIVID)	A high-contrast palette of saturated colors, suited to nature photographs.
 (ASTIA/SOFT)	A soft-toned palette of less saturated colors.
 (MONOCHROME)	Take pictures in black and white.
 (MONOCHROME + Yc FILTER)	Take black-and-white pictures with slightly increased contrast. This setting also slightly tones down the brightness of the sky.
 (MONOCHROME + R FILTER)	Take black-and-white pictures with increased contrast. This setting also tones down the brightness of the sky.
 (MONOCHROME + G FILTER)	Soften skin tones in black-and-white portraits.
 (SEPIA)	Take pictures in sepia.

FILM SIMULATION BKTChoose film types for film simulation bracketing ( 55).

WB WHITE BALANCE**(default: AUTO)**

If **AUTO** does not produce natural colors (for example, when taking close-ups), select  and measure a value for white balance or choose the option that matches the light source.



Option	Description
AUTO	White balance adjusted automatically.
	Measure a value for white balance.
	Selecting this option displays a list of color temperatures; highlight a temperature and press MENU/OK .
	For subjects in direct sunlight.
	For subjects in the shade.
	Use under “daylight” fluorescent lights.
	Use under “warm white” fluorescent lights.
	Use under “cool white” fluorescent lights.
	Use under incandescent lighting.
	For underwater photography

To fine-tune white balance, highlight an option and press **MENU/OK**. Use the selector to adjust white balance or press **DISP/BACK** to use the default white balance value.

WB WHITE BALANCE (Continued)**(default: AUTO)** **Custom White Balance**

Choose  to adjust white balance for unusual lighting conditions. White balance measurement options will be displayed; frame a white object so that it fills the display and press the shutter button all the way down to measure white balance (to select the most recent custom value and exit without measuring white balance, press **DISP/BACK**, or press **MENU/OK** to select the most recent value and display the fine-tuning dialog).

- If **“COMPLETED!”** is displayed, press **MENU/OK** to set white balance to the measured value.
- If **“UNDER”** is displayed, raise exposure compensation ( 44) and try again.
- If **“OVER”** is displayed, lower exposure compensation and try again.

◆ For greater precision, adjust  **FILM SIMULATION**,  **ISO**, and  **DYNAMIC RANGE** before measuring white balance.

- ◆ At settings other than , auto white balance is used with the flash.
- ◆ Results vary with shooting conditions. Play pictures back after shooting to check colors in the display.

WB WHITE BALANCE (Continued)**(default: AUTO)**

 **K: Color Temperature**
 Color temperature is an objective measure of the color of a light source, expressed in Kelvin (K). Light sources with a color temperature close to that of direct sunlight appear white; light sources with a lower color temperature have a yellow or red cast, while those with a higher color temperature are tinged with blue. You can match color temperature to the light source as shown in the following table, or choose options that differ sharply from the color of the light source to make pictures “warmer” or “colder”.

◀ *Choose for redder light sources
 or “colder” pictures*

*Choose for bluer light sources
 or “warmer” pictures* ▶

2,000K

Candlelight

Sunset/sunrise

5,000K

Direct sunlight

Shade

15,000K

Blue sky

Color COLOR**(default: (0) MID)**

Adjust color density.

Sharp SHARPNESS**(default: (0) STANDARD)**

Choose whether to sharpen or soften outlines.

Highlight HIGHLIGHT TONE**(default: (0) STANDARD)**

Adjust the appearance of highlights.







SHADOW TONE (default: **(0) STANDARD**)

Adjust the appearance of shadows.

NR NOISE REDUCTION (default: **(0) STANDARD**)

Choose the amount of noise reduction.

CONTINUOUS (default: )

Capture motion in a series of pictures (📖 52). Choose from , , , , , , and .

ADVANCED ANTI BLUR (default: **ON**)



Select **ON** to enable advanced anti blur in  mode (📖 29).

FACE DETECTION (default: **OFF**)

Choose whether the camera automatically detects and sets focus and exposure for human portrait subjects (📖 60).

PHOTOMETRY (default: )



Choose how the camera meters exposure when Intelligent Face Detection is off.





Option	Description
 MULTI	Automatic scene recognition is used to adjust exposure for a wide range of shooting conditions.
 SPOT	The camera meters lighting conditions at the center of the frame. Recommended when the background is much brighter or darker than the main subject.
<input type="checkbox"/> AVERAGE	Exposure is set to the average for the entire frame. Provides consistent exposure across multiple shots with the same lighting, and is particularly effective for landscapes and portraits of subjects dressed in black or white.

P-AF PRE-AF(default: **OFF**)

When **ON** is selected, the camera continually adjusts focus even when the shutter button is not pressed halfway (note that this increases the drain on the battery and that the sound of the camera focusing may be audible).

RF AF MODE(default: )

Choose how the camera selects the focus area when  is selected in  **FOCUS MODE**. Regardless of the option selected, the camera will focus on the subject in the center of the frame when macro mode is on.

-  **AREA**: Choose the focus area manually ( 59).
 -  **MULTI**: When the shutter button is pressed halfway, the camera detects high-contrast subjects near the center of the frame and selects the focus area automatically.
 -  **TRACKING**: Position the subject in the focus target and press the selector left. The camera will track the subject and adjust focus as it moves through the frame.
- ◆ Note that in  mode, the camera focuses continuously, increasing the drain on the battery, and that the sound of the camera focusing may be audible.

FOCUS MODE

This option controls how the camera focuses subjects ( 57).

FOCUS AREA

This option allows the photographer to change the focus frame position and size ( 59).



MF ASSIST

(default: **FOCUS PEAK HIGHLIGHT**)

Choose how focus is displayed in manual focus mode ( 58).

Option	Description
STANDARD	Focus is displayed normally (focus peaking is not available).
FOCUS PEAK HIGH-LIGHT	The camera heightens high-contrast outlines. Choose from LOW and HIGH .

E-Fn BUTTON CUSTOM SETTING

Choose the role played by the  button, the  button and the selector up, down, left and right ( 49).

CONTROL RING SETTING

(default: **DEFAULT**)

Set functions assigned to the control ring ( 51).

DISP. CUSTOM SETTING

Choose the items displayed in the LCD monitor. The following items can be displayed:

FRAMING GUIDELINE*	ELECTRONIC LEVEL
WHITE BALANCE	APERTURE/S-SPEED/ISO
HISTOGRAM	FRAMES REMAINING
IMAGE SIZE/QUALITY	BATTERY LEVEL
PHOTOMETRY	FLASH
FILM SIMULATION	DYNAMIC RANGE
EXP. COMPENSATION	

* You can also select the grid type (📖 117).

See pages 6 – 7 for the locations of these items in the displays.

Virtual Horizon

Selecting ELECTRONIC LEVEL displays a virtual horizon. The camera is level when the two lines overlap.

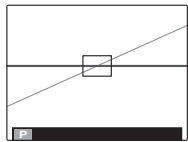









⚠ The virtual horizon may not be displayed if the camera lens is pointed up or down.

FLASH COMPENSATION**(default: ±0)**

Adjust flash brightness. Choose from values between +2EV and -2EV. The default setting is ±0. Note that the desired results may not be achieved depending on shooting conditions and the distance to the subject.

 **MOVIE SET-UP**

Adjust movie settings.

Option	Description
MOVIE MODE	Choose a frame size for movies ( 74).
MOVIE FOCUS MODE	<p>This option controls how the camera selects the focus area for movies.</p> <ul style="list-style-type: none"> •  CENTER: When shooting starts, the camera focuses on the subject in the center of the frame. •  CONTINUOUS: The camera continuously adjusts focus to reflect changes in the distance to subjects near the center of the frame. •  MANUAL FOCUS: Choose for manual control of focus. <p>◆ Note that in  mode, the camera focuses continuously, increasing the drain on the battery, and that the sound of the camera focusing may be audible.</p> <p>◆ If a face is detected when  is selected, a  icon will be displayed and the camera will continuously adjust focus to maintain focus on the face.</p>
STILL SHOOTING IN MOVIE	<p>Choose how the camera records photographs taken during movie recording.</p> <ul style="list-style-type: none"> • MOVIE PRIORITY: The camera takes a photograph without interrupting movie recording. Image size is determined by the option selected for MOVIE MODE. • STILL IMAGE PRIORITY: The camera interrupts filming to take the photograph and resumes filming automatically when recording is complete. Image size is determined by the option selected for  IMAGE SIZE.

 **CUSTOM SET**Save settings for **P**, **S**, **A**, and **M** mode ( 41).

Using the Menus: Playback Mode

Using the Playback Menu

1 Display the playback menu.

- 1.1 Press **MENU/OK** during playback to display the playback menu.

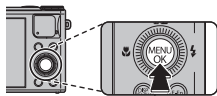

- 1.2 Press the selector left to highlight the current tab.
- 1.3 Press the selector up or down to highlight the tab containing the desired option.

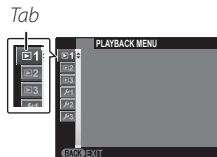

- 1.4 Press the selector right to place the cursor in the menu.

2 Adjust settings.

Highlight items and press the selector right to view options, then highlight an option and press **MENU/OK**. Press **DISP/BACK** to exit when settings are complete.

Playback Menu Options

WIRELESS COMMUNICATION

Connect via a wireless network to upload pictures to smartphones or to remotely browse the pictures on the camera and select images for download. You can also download location data from smartphones. For information on using wireless networks, visit <http://app.fujifilm-dsc.com/>.

PC AUTO SAVE

Upload pictures to a computer over a wireless network. For information on using wireless networks, visit <http://app.fujifilm-dsc.com/>.

IMAGE SEARCH

Search for pictures ( 65).

ERASE



Delete all or selected pictures ( 64).

MARK FOR UPLOAD TO

Select pictures for upload to YouTube or Facebook using MyFinePix Studio (Windows only).

■ Selecting Pictures for Upload

- 1 Select **YouTube** to choose movies for upload to YouTube, **FACEBOOK** to choose photos and movies for upload to Facebook.
- 2 Press the selector left or right to display pictures and press **MENU/OK** to select or deselect. Press **DISP/BACK** to exit when all the desired pictures are selected.

- ◆ Only movies can be selected for upload to YouTube.
- ◆ During playback, selected pictures are indicated by  **YouTube** or  **FACEBOOK** icons.

■ RESET ALL: Deselecting All Pictures

Choose **RESET ALL** to deselect all pictures. If the number of pictures affected is very large, a message will be displayed while the operation is in progress. Press **DISP/BACK** to exit before the operation is complete.

■ Uploading Pictures (Windows Only)

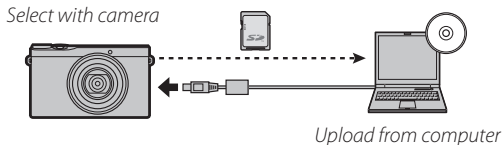

Selected pictures can be uploaded using the **YouTube/Facebook Upload** option in MyFinePix Studio.



For information on installing MyFinePix Studio and connecting the camera to a computer, see "Viewing Pictures on a Computer" (81).

SLIDE SHOW(default: **MULTIPLE**)

View pictures in an automated slide show. Choose the type of show and press **MENU/OK** to start. Press **DISP/BACK** at any time during the show to view on-screen help. The show can be ended at any time by pressing **MENU/OK**.

Option	Description
NORMAL	Press selector left or right to go back or skip ahead one frame. Select FADE-IN for fade transitions between frames.
NORMAL 	As above, except that camera automatically zooms in on faces selected with Intelligent Face detection.
FADE-IN 	
MULTIPLE	Display several pictures at once.

◆ The camera will not turn off automatically while a slide show is in progress.

RAW RAW CONVERSION

Create JPEG copies of RAW pictures. The original image data are unaffected, allowing a single RAW image to be processed in a multitude of different ways.

1 Select **RAW RAW CONVERSION** in the playback menu.

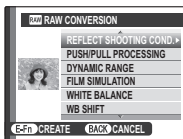

- 2** Press the selector up or down to highlight a setting and press the selector right to select. Press the selector up or down to highlight the desired option and press **MENU/OK** to select and return to the settings list. Repeat this step to adjust additional settings.
- 3** Press the **E-Fn** button to preview the JPEG copy. Press **MENU/OK** to save the copy or press **DISP/BACK** to return to Step 2.



RAW RAW CONVERSION (Continued)

Setting	Description
REFLECT SHOOTING COND.	Create a JPEG copy using the settings in effect at the time the photo was taken.
PUSH/PULL PROCESSING	Adjust exposure by -1 EV to +1 EV in increments of 1/3 EV (📖 44).
DYNAMIC RANGE	Enhance details in highlights for natural contrast (📖 93).
FILM SIMULATION	Simulate the effects of different types of film (📖 94).
WHITE BALANCE	Adjust white balance (📖 95).
WB SHIFT	Fine-tune white balance (📖 95).
COLOR	Adjust color density (📖 97).
SHARPNESS	Sharpen or soften outlines (📖 97).
HIGHLIGHT TONE	Adjust highlights (📖 97).
SHADOW TONE	Adjust shadows (📖 98).
NOISE REDUCTION	Process the copy to reduce mottling (📖 98).

👁️ RED EYE REMOVAL

If the current picture is marked with a 👤 icon to indicate that it was taken with Intelligent Face Detection, this option can be used to remove red-eye. The camera will analyze the image; if red-eye is detected, the image will be processed to create a copy with reduced red-eye.

- 1 Display the desired picture.
- 2 Select 👁️ **RED EYE REMOVAL** in the playback menu.
- 3 Press **MENU/OK**.

- 🔍 Red eye may not be removed if the camera is unable to detect a face or the face is in profile. Results may differ depending on the scene. Red eye can not be removed from pictures that have already been processed using red-eye removal or pictures created with other devices.
- 🔍 The amount of time needed to process the image varies with the number of faces detected.
- 🔍 Copies created with 👁️ **RED EYE REMOVAL** are indicated by a 👁️ icon during playback.

🔒 PROTECT

Protect pictures from accidental deletion.

- 1 Select 🔒 **PROTECT** in the playback menu.
- 2 Highlight one of the following options and press **MENU/OK**:
 - **FRAME**: Protect selected pictures. Press the selector left or right to view pictures and press **MENU/OK** to select or deselect. Press **DISP/BACK** when the operation is complete.
 - **SET ALL**: Protect all pictures.
 - **RESET ALL**: Remove protection from all pictures.

ⓘ Protected pictures will be deleted when the memory card or internal memory is formatted (📄 123).

CROP

Create a cropped copy of the current picture.

- 1 Display the desired picture.
 - 2 Select  **CROP** in the playback menu.
 - 3 Use the zoom control to zoom in and out and use the selector to scroll the picture until the desired portion is displayed.
 - 4 Press **MENU/OK** to display a confirmation dialog.
 - 5 Press **MENU/OK** again to save the cropped copy to a separate file.
- ◆ Larger crops produce larger copies; all copies have an aspect ratio of 4:3. If the size of the final copy will be **640**, **OK** will be displayed in yellow.

RESIZE

Create a small copy of the current picture.

- 1 Display the desired picture.
 - 2 Select  **RESIZE** in the playback menu.
 - 3 Highlight a size and press **MENU/OK** to display a confirmation dialog.
 - 4 Press **MENU/OK** to save the resized copy to a separate file.
- ◆ The sizes available vary with the size of the original image.
-

IMAGE ROTATE

Rotate pictures taken in tall orientation so that they are displayed in tall orientation in the LCD monitor.

- 1 Display the desired picture.
 - 2 Select **IMAGE ROTATE** in the playback menu.
 - 3 Press the selector down to rotate the picture 90° clockwise, up to rotate it 90° counterclockwise.
 - 4 Press **MENU/OK**. The picture automatically be displayed in the selected orientation whenever it is played back on the camera.
- ◆ Protected pictures can not be rotated. Remove protection before rotating pictures (📖 109).
 - ◆ The camera may not be able to rotate pictures created with other devices.

COPY COPY

Copy pictures from internal memory to a memory card.

- 1 Select **COPY COPY** in the playback menu.
 - 2 Highlight one of the following options and press the selector right:
 - **INTERNAL MEMORY → SD CARD**: Copy pictures from internal memory to a memory card.
 - **SD CARD → INTERNAL MEMORY**: Copy pictures from a memory card to internal memory.
 - 3 Highlight one of the following options and press **MENU/OK**:
 - **FRAME**: Copy selected pictures. Press the selector left or right to view pictures and press **MENU/OK** to copy the current picture.
 - **ALL FRAMES**: Copy all pictures.
- ◆ Copying ends when the destination is full.
 - ◆ DPOF print information is not copied (📖 79).

 **PHOTOBOOK ASSIST**

Create books from your favorite photos (🗨 66).

 **PRINT ORDER (DPOF)**

Select pictures for printing on DPOF- and PictBridge-compatible devices (🗨 79).

 **DISP ASPECT**

Choose how High Definition (HD) devices display pictures with an aspect ratio of 4:3 (this option is available only when an HDMI cable is connected). Select **16:9** to display the image so that it fills the screen with its top and bottom cropped out, **4:3** to display the entire image with black bands at either side.

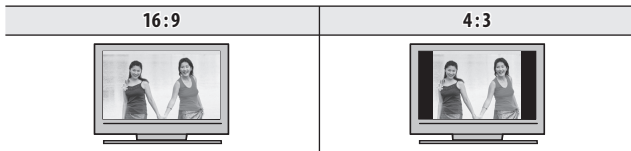
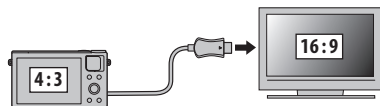

- ◆ Photographs with an aspect ratio of 16:9 are displayed full screen, those with an aspect ratio of 3:2 in a black frame.

The Setup Menu

Using the Setup Menu

1 Display the setup menu.

- 1.1 Press **MENU/OK** to display the menu for the current mode.

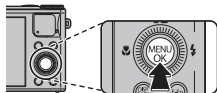

- 1.2 Press the selector left to highlight the tab for the current menu.

- 1.3 Press the selector down to highlight the tab containing the desired option.

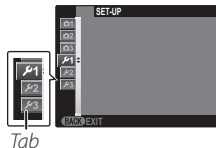

- 1.4 Press the selector right to place the cursor in the menu.

2 Adjust settings.

Highlight items and press the selector right to view options, then highlight an option and press **MENU/OK**. Press **DISP/BACK** to exit when settings are complete.

Setup Menu Options

DATE/TIME



Set the camera clock ( 21).





TIME DIFFERENCE

(default: )

Switch the camera clock instantly from your home time zone to the local time at your destination when traveling. To specify the difference between local time and your home time zone:

- 1 Highlight  **LOCAL** and press the selector right.
- 2 Use the selector to choose the time difference between local time and your home time zone.
- 3 Press **MENU/OK**.

To switch between local time and your home time zone, highlight  **LOCAL** or  **HOME** and press **MENU/OK**.

Option	Description
 HOME	Switch to the time currently selected for  DATE/TIME (see above).
 LOCAL	Switch to local time. If this option is selected,  and the time and date will be displayed in yellow for three seconds each time the camera is turned on.

言語/LANG.

Choose a language.

RESET

Reset shooting or setup menu options to default values. **DATE/TIME**, **TIME DIFFERENCE** and **SCREEN SET-UP > BACKGROUND COLOR** are not affected.

- 1 Highlight the desired option and press the selector right.
- 2 A confirmation dialog will be displayed; highlight **OK** and press **MENU/OK**.

SILENT MODE(default: **OFF**)

Select **ON** to disable the speaker, flash, and AF-assist illuminator in situations in which camera sounds or lights may be unwelcome.

CONTROL RING(default: **CW**)

Choose the direction in which the control ring is rotated to increase the focus distance.

FOCUS CHECK(default: **ON**)



If **ON** is selected for **FOCUS CHECK**, the image will be magnified in the display to assist focus when the control ring is rotated in manual focus mode (58). The camera must be in manual focus mode.

GEOTAGGING SET-UP

Access location data options. For information on using wireless networks, visit <http://app.fujifilm-dsc.com/>.



SOUND SET-UP

Adjust sound settings.

Option	Description
OPERATION VOL.	Adjust the volume of the sounds produced when camera controls are operated. Choose  OFF (mute) to disable control sounds.
SHUTTER VOLUME	Adjust the volume of the sounds produced when the shutter is released. Choose  OFF (mute) to disable the shutter sound.
SHUTTER SOUND	Choose the sound made by the shutter.
PLAYBACK VOLUME	Adjust the volume for movie playback.



 **SCREEN SET-UP**

Adjust display settings.

Option	Description
IMAGE DISP.	<p>Choose how long pictures are displayed in the LCD monitor after shooting.</p> <ul style="list-style-type: none"> • 1.5 SEC, 0.5 SEC: Pictures are displayed for 1.5 seconds (1.5 SEC) or 0.5 seconds (0.5 SEC). Colors may differ slightly from those in the final image. • ZOOM (CONTINUOUS): Pictures are displayed until the MENU/OK button is pressed. • OFF: Pictures are not displayed after shooting.
PREVIEW EXP. IN MANUAL MODE	<ul style="list-style-type: none"> • When ON is selected, exposure setting is applied to the image displayed in the LCD monitor. • Choose OFF when exposure changes, such as using flash.
LCD BRIGHTNESS	Control the brightness of the display.
MONITOR SUNLIGHT MODE	Select ON to make the display in the monitor easier to read in bright light.
FRAMING GUIDLINE	<p>Choose the type of framing grid available in shooting mode.</p> <ul style="list-style-type: none"> •  GRID 9: For “rule of thirds” composition. •  GRID 24: A six-by-four grid. •  HD FRAMING: Frame HD pictures in the crop shown by the lines at the top and bottom of the display.
AUTOROTATE PB	Choose ON to automatically rotate “tall” (portrait-orientation) pictures during playback.
BACKGROUND COLOR	Choose a color scheme.





POWER MANAGEMENT

Adjust power management settings.

Option	Description
AUTO POWER OFF	Choose the length of time before the camera turns off automatically when no operations are performed. Shorter times increase battery life; if OFF is selected, the camera must be turned off manually. Note that in some situations the camera turns off automatically even when OFF is selected.
POWER MANAGEMENT	<p>Optimize camera performance for increased battery life or display quality.</p> <ul style="list-style-type: none"> •  POWER SAVE: The display dims to save power if no operations are performed for a short period, but can be restored by operating camera controls. Select this option to save power. •  HIGH PERFORMANCE: Choose for a brighter display and faster focus. <p> POWER SAVE does not take effect when Intelligent Face Detection is on.</p>

IS MODE (default: )



Choose from the following image stabilization options:

Option	Description
 CONTINUOUS + MOTION	Image stabilization on. If + MOTION is selected, the camera will adjust shutter speed to reduce motion blur when a moving objects are detected.
 CONTINUOUS	
 SHOOTING + MOTION	As above, except that image stabilization is performed only when the shutter button is pressed halfway or the shutter is released.
 SHOOTING ONLY	
OFF	Image stabilization off. Choose this option when using a tripod.

 **+ MOTION** has no effect when sensitivity is set to a fixed value, and may also be unavailable at some other combinations of settings. The effect may vary with lighting conditions and the speed at which the object is moving.

RED EYE REMOVAL (default: **ON**)

Choose **ON** to remove red-eye effects caused by the flash when shooting with Intelligent Face Detection.

-  Red-eye reduction is performed only when a face is detected.
-  Red-eye removal is not available with RAW images.

INTELLIGENT DIGITAL ZOOM(default: **ON**)

If **ON** is selected, selecting [Z] at the maximum optical zoom position triggers intelligent digital zoom, further magnifying the image while processing it for sharp, high-resolution results.

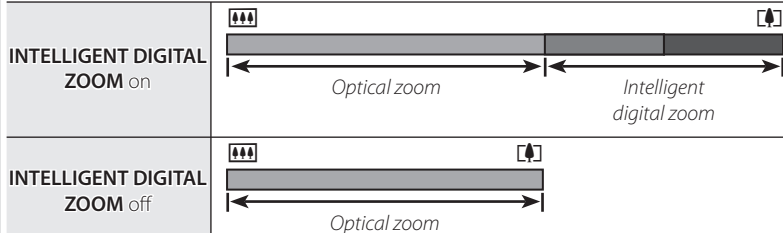
The Zoom Indicator

- ◆ Intelligent digital zoom may sometimes produce lower quality images than optical zoom.
- ◆ Intelligent digital zoom operates in 2 steps (low zoom ratio/high zoom ratio).
- ◆ Intelligent digital zoom with high zoom ratio produces lower quality images than that of low zoom ratio.
- ◆ Intelligent digital zoom is not available in continuous mode or during movie recording.

AF ILLUMINATOR(default: **ON**)

If **ON** is selected, the AF-assist illuminator will light to assist autofocus.



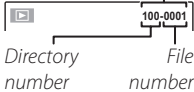

- ⓘ The camera may be unable to focus using the AF-assist illuminator in some cases. If the camera is unable to focus in macro mode, try increasing the distance to the subject.
- ⓘ Avoid shining the AF-assist illuminator directly into your subject's eyes.

SAVE DATA SET-UP

Adjust file-management settings.

Option	Description
FRAME NO.	<p>New pictures are stored in image files named using a four-digit file number assigned by adding one to the last file number used. The file number is displayed during playback as shown at right. FRAME NO. controls whether file numbering is reset to 0001 when a new memory card is inserted or the current memory card or internal memory is formatted.</p> <div data-bbox="764 184 985 326" style="text-align: right;"> <p><i>Frame number</i></p>  </div> <ul style="list-style-type: none"> • CONTINUOUS: Numbering continues from the last file number used or the first available file number, whichever is higher. Choose this option to reduce the number of pictures with duplicate file names. • RENEW: Numbering is reset to 0001 after formatting or when a new memory card is inserted. <ul style="list-style-type: none"> ◆ If the frame number reaches 999-9999, the shutter release will be disabled (136). ◆ Selecting RESET (115) sets FRAME NO. to CONTINUOUS but does not reset the file number. ◆ Frame numbers for pictures taken with other cameras may differ.
SAVE ORG IMAGE	<p>Choose ON to save unprocessed copies of seamless panoramas or pictures taken using RED EYE REMOVAL, PRO LOW-LIGHT MODE, or PRO FOCUS MODE.</p>

SAVE DATA SET-UP (Continued)

Option	Description
DATE STAMP	<p>Stamp the time and/or date of recording on photographs as they are taken.</p> <ul style="list-style-type: none"> • +: Stamp new photographs with the date and time of recording. • : Stamp new photographs with the date of recording. • OFF: Do not stamp the time and date on new photographs. <p>① Time and date stamps can not be deleted. Turn DATE STAMP off to prevent time and date stamps appearing on new photographs.</p> <p>① If the camera clock is not set, you will be prompted to set the clock to the current date and time ( 21).</p> <p>① We recommend that you turn the DPOF “print date” option off when printing images with a time and date stamp ( 79).</p> <p>① Time and date stamps do not appear on movies, panoramas, or pictures taken with best frame capture.</p>

CUSTOM RESET

Reset all settings for mode **C**. A confirmation dialog will be displayed, press the selector up or down to highlight **OK** and press **MENU/OK**.

WIRELESS SETTINGS

Adjust settings for connection to a wireless network. For information on using wireless networks, visit <http://app.fujifilm-dsc.com/>.

PC AUTO SAVE SETTING

Choose a destination for images uploaded using  **PC AUTO SAVE**. For information on using wireless networks, visit <http://app.fujifilm-dsc.com/>.

FORMAT

If a memory card is inserted in the camera, this option will format the memory card. If no memory card is inserted, this option will format internal memory.

- ⓘ All data—including protected pictures—will be deleted from the memory card or internal memory. Be sure important files have been copied to a computer or other storage device.
- ⓘ Do not open the battery-chamber cover during formatting.

Technical Notes

Optional Accessories

The camera supports a wide range of accessories from FUJIFILM and other manufacturers.

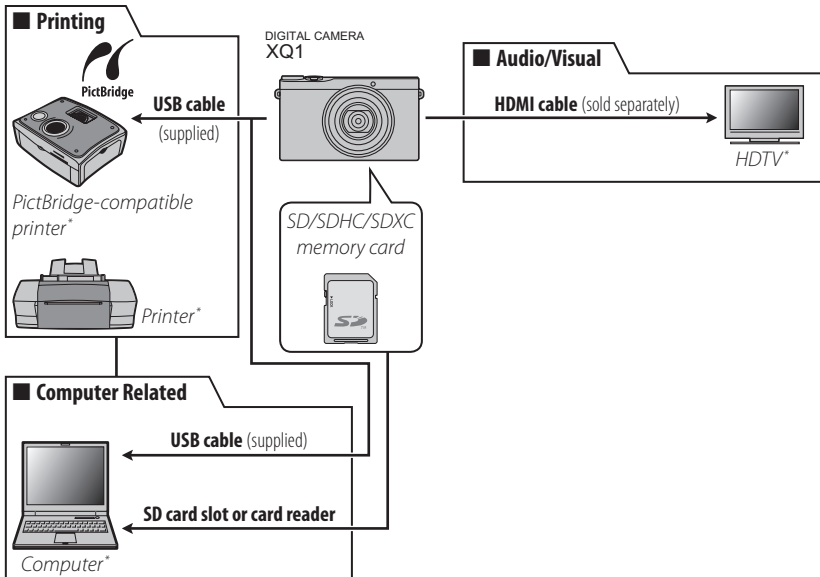

* Available separately.

Accessories from FUJIFILM

The following optional accessories are available from FUJIFILM. For the latest information on the accessories available in your region, check with your local FUJIFILM representative or visit http://www.fujifilm.com/products/digital_cameras/index.html.

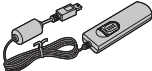
Rechargeable Li-ion batteries	NP-48: Additional large-capacity NP-48 rechargeable batteries can be purchased as required.	
Remote releases	RR-90: Use to reduce camera shake or keep the shutter open during a time exposure.	
Leather case	BLC-XQ1: This case, exclusively for use with the XQ1, is made with genuine leather and comes with a shoulder strap of the same material and a cloth case.	

Caring for the Camera

To ensure continued enjoyment of the product, observe the following precautions.

Storage and Use

If the camera will not be used for an extended period, remove the battery and memory card. Do not store or use the camera in locations that are:

- exposed to rain, steam, or smoke
- very humid or extremely dusty
- exposed to direct sunlight or very high temperatures, such as in a closed vehicle on a sunny day
- extremely cold
- subject to strong vibration
- exposed to strong magnetic fields, such as near a broadcasting antenna, power line, radar emitter, motor, transformer, or magnet
- in contact with volatile chemicals such as pesticides
- next to rubber or vinyl products

■ **Water and Sand (excluding waterproof products)**

Exposure to water and sand can also damage the camera and its internal circuitry and mechanisms. When using the camera at the beach or seaside, avoid exposing the camera to water or sand. Do not place the camera on a wet surface.

■ **Condensation**

Sudden increases in temperature, such as occur when entering a heated building on a cold day, can cause condensation inside the camera. If this occurs, turn the camera off and wait an hour before turning it on again. If condensation forms on the memory card, remove the card and wait for the condensation to dissipate.

Cleaning

Use a blower to remove dust from the lens and LCD monitor, then gently wipe with a soft, dry cloth. Any remaining stains can be removed by wiping gently with a piece of FUJIFILM lens-cleaning paper to which a small amount of lens-cleaning fluid has been applied. Care should be taken to avoid scratching the lens or LCD monitor. The camera body can be cleaned with a soft, dry cloth. Do not use alcohol, thinner, or other volatile chemicals.









Traveling



Keep the camera in your carry-on baggage. Checked baggage may suffer violent shocks that could damage the camera.

Troubleshooting

Problems and Solutions

■ Power and Battery







Problem	Solution
The camera does not turn on.	<ul style="list-style-type: none">• The battery is exhausted: Charge the battery or insert a fully-charged spare battery (📖 17).• The battery is inserted incorrectly: Reinsert in the correct orientation (📖 12).• The battery-chamber cover is not latched: Latch the battery-chamber cover (📖 12).
The battery runs down quickly.	<ul style="list-style-type: none">• The battery is cold: Warm the battery by placing it in a pocket or other warm place and reinsert it in the camera immediately before taking a picture.• There is dirt on the battery terminals: Clean the terminals with a soft, dry cloth.•  HIGH PERFORMANCE is selected for  POWER MANAGEMENT > POWER MANAGEMENT: Select  POWER SAVE to reduce the drain on the battery (📖 118).• ON is selected for  SCREEN SET-UP > MONITOR SUNLIGHT MODE: Select OFF to reduce the drain on the battery (📖 8).•  is selected for shooting mode: Select  mode to reduce the drain on the battery (📖 27).• ON is selected for  PRE-AF: Select OFF to reduce the drain on the battery (📖 99).•  TRACKING is selected for  AF MODE: Select a different AF mode (📖 57).• The battery has been charged many times: The battery has reached the end of its charging life. Purchase a new battery.
The camera turns off suddenly.	<ul style="list-style-type: none">• The battery is exhausted: Charge the battery or insert a fully-charged spare battery (📖 17).
Charging does not start.	Reinsert the battery in the correct orientation and make sure that the power connection is made (📖 12, 17).
Charging is slow.	Charge the battery at room temperature (📖 iv).



Problem	Solution
The indicator lamp flashes or  appears in the LCD monitor, and the battery does not charge.	<ul style="list-style-type: none"> • There is dirt on the battery terminals: Clean the terminals with a soft, dry cloth. • The battery has been charged many times: The battery has reached the end of its charging life. Purchase a new battery. If the battery still fails to charge, contact your FUJIFILM dealer. • The battery is too hot or too cold: Wait for the battery temperature to stabilize ( 17).

■ Menus and Displays

Problem	Solution
Menus and displays are not in English.	Select ENGLISH for  言語/LANG. ( 21, 114).

■ Shooting

Problem	Solution
No picture is taken when the shutter button is pressed.	<ul style="list-style-type: none"> • Memory is full: Insert a new memory card or delete pictures ( 13, 64). • Memory is not formatted: Format the memory card or internal memory ( 123). • There is dirt on the memory card contacts: Clean the contacts with a soft, dry cloth. • The memory card is damaged: Insert a new memory card ( 13). • The battery is exhausted: Charge the battery or insert a fully-charged spare battery ( 17). • The camera has turned off automatically: Turn the camera on ( 19). • The indicator lamp was orange when you attempted to record a panorama: Wait until the indicator lamps turns off ( 5).
The LCD monitor goes dark after shooting.	The LCD monitor may darken while the flash charges. Wait for the flash to charge ( 46).

Problem	Solution
The camera does not focus.	<ul style="list-style-type: none"> • The subject is close to the camera: Select macro mode (📖 45). • The subject is far away from the camera: Cancel macro mode (📖 45). • The subject is not suited to autofocus: Use focus lock (📖 42).
Macro mode is not available.	Choose a different shooting mode (📖 27).
Intelligent Face Detection is not available.	Intelligent Face Detection is not available in the current shooting mode: Choose a different shooting mode (📖 27).
No face is detected.	<ul style="list-style-type: none"> • The subject's face is obscured by sunglasses, a hat, long hair, or other objects: Remove the obstructions. • The subject's face occupies only a small area of the frame: Change the composition so that the subject's face occupies a larger area of the frame (📖 42). • The subject's head is tilted or horizontal: Ask the subject to hold their head straight. • The camera is tilted: Keep the camera level (📖 24). • The subject's face is poorly lit: Shoot in bright light.
Wrong subject is selected.	The selected subject is closer to the center of the frame than the main subject. Recompose the picture or turn face detection off and frame the picture using focus lock (📖 42).
The flash does not fire.	<ul style="list-style-type: none"> • The flash is not available in the current shooting mode: Choose a different shooting mode (📖 27). • The battery is exhausted: Charge the battery or insert a fully-charged spare battery (📖 17). • The camera is in continuous mode: Select  for  CONTINUOUS (📖 52). • The camera is in silent mode: Turn silent mode off (📖 115). • The flash is not raised: Raise the flash (📖 46).
Some flash modes are not available.	<ul style="list-style-type: none"> • The desired flash mode is not available in the current shooting mode: Choose a different shooting mode (📖 27). • The camera is in silent mode: Turn silent mode off (📖 115).

Problem	Solution
The flash does not fully light the subject.	<ul style="list-style-type: none"> • The subject is not in range of the flash: Position the subject in range of the flash (📖 141). • The flash window is obstructed: Hold the camera correctly (📖 24). • Fast shutter speed selected: Choose a slower shutter speed (📖 37, 39).
Pictures are blurred.	<ul style="list-style-type: none"> • The lens is dirty: Clean the lens (📖 127). • The lens is blocked: Keep objects away from the lens (📖 24). • !AF is displayed during shooting and the focus frame is displayed in red: Check focus before shooting (📖 134). • ! is displayed during shooting: Use the flash or a tripod (📖 47).
Pictures are mottled.	<ul style="list-style-type: none"> • A slow shutter speed is selected at high temperatures: This is normal and does not indicate a malfunction. • The camera has been used continuously at high temperatures or a temperature warning is displayed: Turn the camera off and wait for it to cool down.
Location data	Location data are incorrect. The camera has been moved since location data were last updated.
Sounds made by the camera are recorded with movies.	<ul style="list-style-type: none"> • 📺 CONTINUOUS is selected for 🎬 MOVIE SET-UP > MOVIE FOCUS MODE: Select a different AF mode (📖 102). • Zoom was adjusted during shooting: Do not adjust zoom during shooting. • Intelligent Face Detection is on: Turn Intelligent Face Detection off (📖 60).



■ Playback

Problem	Solution
Pictures are grainy.	The pictures were taken with a different make or model of camera.
Playback zoom unavailable.	The picture has been saved at 640 , or is from another make or model of camera (📖 62).



Problem	Solution
No sound in movie playback.	<ul style="list-style-type: none"> • Playback volume is too low: Adjust playback volume (📖 116). • The microphone was obstructed: Hold the camera correctly during recording (📖 2, 24). • The speaker is obstructed: Hold the camera correctly during playback (📖 2, 24).
Selected pictures are not deleted.	Some of the pictures selected for deletion are protected. Remove protection using the device with which it was originally applied (📖 109).
File numbering is unexpectedly reset.	The battery-chamber cover was opened while the camera was on. Turn the camera off before opening the battery-chamber cover.

■ Connections/Miscellaneous

Problem	Solution
No picture or sound.	<ul style="list-style-type: none"> • The camera is not properly connected: Connect the camera properly (📖 76). • Input on the television is set to “TV”: Set input to “HDMI”. • The volume on the TV is too low: Adjust the volume.
The computer does not recognize the camera.	Be sure the camera and computer are correctly connected (📖 86).
Can not transfer RAW or JPEG files to computer.	Use the bundled software to transfer pictures (📖 81).
Pictures can not be printed.	<ul style="list-style-type: none"> • The camera is not properly connected: Connect the camera correctly (📖 77). • The printer is off: Turn the printer on.
Only one copy is printed/ the date is not printed.	The printer is not PictBridge compatible.
The camera is unresponsive.	<ul style="list-style-type: none"> • Temporary camera malfunction: Remove and reinsert the battery (📖 12) or disconnect and reconnect the AC power adapter. • The battery is exhausted: Charge the battery (📖 17) or insert a fully-charged spare battery (📖 12).
The camera does not function as expected.	Remove and reinsert the battery (📖 12) or disconnect and reconnect the AC power adapter. If the problem persists, contact your FUJIFILM dealer.

Problem	Solution
No sound.	Turn silent mode off (📖 115).
Hue or content of display changes unexpectedly.	Choose OFF for  SCREEN SET-UP > MONITOR SUNLIGHT MODE (📖 8).
Time and date stamps	<ul style="list-style-type: none"> • Time and date stamps are not correct: Set the camera clock (📖 21). • Time and date stamps appear on photographs: Time and date stamps can not be deleted. To prevent stamps appearing on new photographs, select OFF for  SAVE DATA SET-UP > DATE STAMP (📖 122).







■ Wireless Networks

Problem	Solution
Problem connecting or uploading pictures to smartphone.	<ul style="list-style-type: none"> • The smartphone is too far away: Move the devices closer. • Nearby devices are causing radio interference: Move the camera and smartphone away from microwave ovens or cordless phones.
Can not upload images.	<ul style="list-style-type: none"> • The smartphone is connected to another device: The smartphone and camera can connect to only one device at a time. End the connection and try again. • There are several smartphones in the vicinity: Try connecting again. The presence of multiple smartphones can make connection difficult.
Selecting TRANSMIT or tapping  has no effect.	The current image is a movie or was created on another device and can not be uploaded to a smartphone.
Smartphone will not display pictures.	Select ON for  WIRELESS SETTING > RESIZE IMAGE FOR SMARTPHONE  . Selecting OFF increases upload times for larger images; in addition, some phones may not display images over a certain size.













* For information on using wireless networks, visit <http://app.fujifilm-dsc.com/>.



Warning Messages and Displays

The following warnings are displayed in the LCD monitor:

Warning	Description
 (red)	Charging is not available. See page 129.
 (red)	Low battery. Charge the battery (📖 17) or insert a fully-charged spare battery (📖 12).
 (blinks red)	Battery exhausted. Charge the battery (📖 17) or insert a fully-charged spare battery (📖 12).
	Slow shutter speed. Pictures may be blurred; use the flash or a tripod.
!AF (displayed in red with red focus frame)	The camera can not focus. Try one of the following solutions: <ul style="list-style-type: none">• Use focus lock to focus on another subject at the same distance, then recompose the picture (📖 42).• Use macro mode to focus when taking close-ups (📖 45).
Aperture or shutter speed displayed in red	The subject is too bright or too dark and the picture will be over- or under-exposed. If the subject is dark, use the flash (📖 46).
FOCUS ERROR	
TURN OFF THE CAMERA AND TURN ON AGAIN	Camera malfunction or moving parts of lens obstructed. Turn the camera off and then on again, taking care not to touch the lens. If the message persists, contact a FUJIFILM dealer.
LENS CONTROL ERROR	
CARD NOT INITIALIZED	<ul style="list-style-type: none">• The memory card or internal memory is not formatted or the memory card was formatted in a computer or other device: Format the memory card or internal memory using the  FORMAT option in the camera setup menu (📖 123).• The memory card contacts require cleaning: Clean the contacts with a soft, dry cloth. If the message is repeated, format the card (📖 123). If the message persists, replace the card.• Camera malfunction: Contact a FUJIFILM dealer.
PROTECTED CARD	The memory card is locked. Unlock the card (📖 13).
BUSY	The memory card is incorrectly formatted. Use the camera to format the card (📖 123).
	Turn the camera off and wait for it to cool. If no action is taken, the camera will turn off automatically.

Warning	Description
CARD ERROR	The memory card is not formatted for use in the camera. Format the card (📖 123).
	The memory card contacts require cleaning or the memory card is damaged. Clean the contacts with a soft, dry cloth. If the message is repeated, format the card (📖 123). If the message persists, replace the card.
	Incompatible memory card. Use a compatible card (📖 15).
	Camera malfunction. Contact a FUJIFILM dealer.
MEMORY FULL	
INTERNAL MEMORY IS FULL INSERT A NEW CARD	The memory card or internal memory is full and pictures can not be recorded or copied. Delete pictures or insert a memory card with more free space.
WRITE ERROR	<ul style="list-style-type: none"> • Memory card error or connection error: Reinsert the card or turn the camera off and then on again. If the message persists, contact a FUJIFILM dealer. • Not enough memory remaining to record additional pictures: Delete pictures or insert a memory card with more free space. • The memory card or internal memory is not formatted: Format the memory card or internal memory (📖 123).
READ ERROR	<ul style="list-style-type: none"> • The file is corrupt or was not created with the camera: The file can not be viewed. • The memory card contacts require cleaning: Clean the contacts with a soft, dry cloth. If the message is repeated, format the card (📖 123). If the message persists, replace the card. • Camera malfunction: Contact a FUJIFILM dealer.

Warning	Description
FRAME NO. FULL	The camera has run out of frame numbers (current frame number is 999-9999). Format the memory card and select RENEW for  SAVE DATA SET-UP > FRAME NO. Take a picture to reset frame numbering to 100-0001, then select CONTINUOUS for FRAME NO. ( 121).
TOO MANY FRAMES	<ul style="list-style-type: none"> • A search has returned more than 30,000 results: Choose a search that returns fewer results. • More than 999 images are selected for deletion: Choose fewer images.
PROTECTED FRAME	An attempt was made to delete or rotate a protected picture. Remove protection and try again ( 109).
 CAN NOT CROP	 pictures can not be cropped.
CAN NOT CROP	The picture is damaged or was not created with the camera.
 CANNOT EXECUTE	An attempt was made to create a resized copy at a size equal to or larger than the original. Choose a smaller size.
 CANNOT EXECUTE	
 CANNOT EXECUTE	
CAN NOT ROTATE	An attempt was made to rotate a picture that can not be rotated.
 CAN NOT ROTATE	Movies can not be rotated.
 CANNOT EXECUTE	Red-eye removal can not be applied to the selected picture.
 CANNOT EXECUTE	Red-eye removal can not be applied to movies.
NO CARD	No memory card inserted when  COPY is selected. Insert a memory card.

Warning	Description
NO IMAGE	The source selected for  COPY contains no images. Select a different source.
DPOF FILE ERROR	The DPOF print order on the current memory card contains more than 999 images. Copy the pictures to internal memory and create a new print order.
CAN NOT SET DPOF	The picture can not be printed using DPOF.
 CAN NOT SET DPOF	Movies can not be printed using DPOF.
COMMUNICATION ERROR	A connection error occurred while pictures were being printed or copied to a computer or other device. Confirm that the device is turned on and that the USB cable is connected.
PRINTER ERROR	Printer out of paper or ink, or other printer error. Check printer (see printer manual for details). To resume printing, turn the printer off and then turn it back on.
PRINTER ERROR RESUME?	Printer out of paper or ink, or other printer error. Check printer (see printer manual for details). If printing does not resume automatically, press MENU/OK to resume.
CANNOT BE PRINTED	An attempt was made to print a movie, a picture not created with the camera, or a picture in a format not supported by the printer. Movies and some pictures created with other devices can not be printed; if the picture is a still picture created with the camera, check the printer manual to confirm that the printer supports the JFIF-JPEG or Exif-JPEG format. If it does not, the pictures can not be printed.

Appendix

Memory Card Capacity

The following table shows the recording time or number of pictures available at different image sizes. All figures are approximate; file size varies with the scene recorded, producing wide variations in the number of files that can be stored, and the number of exposures or length remaining may not diminish at an even rate. A limited number of test pictures can be taken when no memory card is inserted.

Photographs

		L				M				S				RAW
		4:3	3:2	16:9	1:1	4:3	3:2	16:9	1:1	4:3	3:2	16:9	1:1	
4 GB	FINE	800	900	1060	1060	1280	1450	1690	1690	2360	2620	3440	3090	200
	NORMAL	1260	1410	1670	1670	2460	2800	3250	3250	4460	5020	6340	5740	
8 GB	FINE	1590	1800	2120	2120	2540	2880	3370	3370	4700	5210	6840	6140	410
	NORMAL	2520	2810	3320	3320	4890	5570	6470	6470	8870	9980	12610	11410	

Movie

	FHD 1920 × 1080 (60 fps) ¹	HD 1280 × 720 (60 fps) ²	640 640 × 480 (30 fps) ³	HS 640 × 480 (80 fps) ⁴	HS 320 × 240 (150 fps) ⁴	HS 320 × 112 (250 fps) ⁴
4 GB	13 min.	25 min.	112 min.	83 min.	167 min.	83 min.
8 GB	26 min.	51 min.	223 min.	166 min.	332 min.	166 min.









1 Use a CLASS10 card or better. Individual movies can not exceed 14 minutes in length.

2 Use a CLASS10 card or better. Individual movies can not exceed 27 minutes in length.

3 Individual movies can not exceed 115 minutes in length.

4 Use a CLASS10 card or better. Individual movies can not exceed 30 seconds in length.

Specifications

System	
Model	XQ1
Effective pixels	12 million
Image sensor	$\frac{2}{3}$ -in., X-Trans CMOS II sensor with primary color filter
Storage media	• Internal memory (approx. 66 MB) • SD/SDHC/SDXC memory cards
File system	Compliant with Design Rule for Camera File System (DCF), Exif 2.3, and Digital Print Order Format (DPOF)
File format	• Still pictures: Exif 2.3 JPEG (compressed); RAW (original RAF format, special-purpose software required); RAW+JPEG available • Movies: H.264 standard with linear PCM stereo sound (MOV)
Image size (pixels)	• L 4:3: 4,000 × 3,000 • L 3:2: 4,000 × 2,664 • L 16:9: 4,000 × 2,248 • L 1:1: 2,992 × 2,992 • M 4:3: 2,816 × 2,112 • M 3:2: 2,816 × 1,864 • M 16:9: 2,816 × 1,584 • M 1:1: 2,112 × 2,112 • S 4:3: 2,048 × 1,536 • S 3:2: 2,048 × 1,360 • S 16:9: 1,920 × 1,080 • S 1:1: 1,536 × 1,536 •  MOTION PANORAMA  1,624 × 11,520 (tall)/11,520 × 1,080 (wide) •  MOTION PANORAMA  1,624 × 5,760 (tall)/5,760 × 1,080 (wide) •  MOTION PANORAMA  1,624 × 3,840 (tall)/3,840 × 1,080 (wide) •  MOTION PANORAMA  1,624 × 11,520 (tall)/11,520 × 1,080 (wide)
Lens	Fujinon 4 × optical zoom lens, F1.8 (wide angle) – F4.9 (telephoto)
Focal length	f=6.4 mm–25.6 mm (35-mm format equivalent: 25 mm–100 mm)
Digital zoom	Up to about 4 × with intelligent digital zoom (up to 16 × when combined with optical zoom)
Aperture	F1.8–F11 (wide angle)/F4.9–F11 (telephoto) in increments of $\frac{1}{3}$ EV
Focus range (distance from front of lens)	Approx. 50 cm (1.6 ft.)–infinity (wide angle); 80 cm (2.6 ft.)–infinity (telephoto) • Macro: approx. 3 cm–3.0 m/1.1 in.–9.8 ft. (wide angle); 50 cm–3.0 m/1.6 ft.–9.8 ft. (telephoto)
Sensitivity	Standard output sensitivity equivalent to ISO 100, 200, 250, 320, 400, 500, 640, 800, 1000, 1250, 1600, 2000, 2500, 3200, 4000, 5000, 6400, 12800; AUTO
Metering	256-segment through-the-lens (TTL) metering; MULTI, SPOT, AVERAGE

System

Exposure control Programmed AE; aperture-priority AE; shutter-priority AE; manual exposure

Exposure compensation -3 EV - +3 EV in increments of 1/3 EV
-2 EV - +2 EV in increments of 1/3 EV (👤)

Picture stabilization Optical stabilization (lens-shift type)

Shutter speed (combined mechanical and electronic shutter)

- 🌙: 1/4 s - 1/1,000 s
- 🌙*: 3 s - 1/1,000 s
- 🌙: 4 s - 1/2 s
- 📷, **Filter, SP** (except 🌙, 🌙*, and 🌙): 1/4 s - 1/3,000 s
- 📷: 4 s - 1/3,000 s
- 📷: 1/30 s - 1/500 s
- 📷: 1/8 s - 1/3,000 s
- 📷: 1/5 s - 1/3,000 s
- **Other modes:** 30 s - 1/4,000 s

Continuous

	Approx. frame rate (fps) ^{*1}	Continuous frames (Image size) ^{*2}
📷 ^{*3}	3.0	200 (L M S)
M	6.0	14 (L M S)
H	9.0	11 (L M S)
SH	12.0	9 (L M S)
📷 ^{*3}	3.0, 6.0, 9.0, 12.0	8 (L M S)
📷		3 frames (selected exposure, overexposure, underexposure)
ISO	—	3 frames (selected sensitivity, sensitivity raised, sensitivity lowered)
📷		3 frames (STW , VF , S , B , BV , B , B , B , B , B , B)
DR		3 frames (100%, 200%, 400%)

*1 The frame rate varies with shooting conditions and the number of images recorded.

*2 Use a **CLASS 10** card or better.

*3 When **AF-C** is selected for the focus mode and 📷 for a frame rate, the camera adjusts focus and exposure automatically during continuous shooting. The frame rate is different in **AF-S**.

System

Focus	<ul style="list-style-type: none"> • Mode: Single AF, continuous AF, manual focus • Focus-area selection: Multi, area, tracking • Autofocus system: Intelligent hybrid AF (TTL contrast-detect/phase-detection AF) with AF-assist illuminator
--------------	---

White balance	Automatic scene detection; manual preset modes for direct sunlight, shade, daylight fluorescent, warm white fluorescent, cool white fluorescent, incandescent lighting, underwater; color temperature, custom white balance
----------------------	---

Self-timer	Off, 2 sec., 10 sec.
-------------------	----------------------

Flash	Manual pop-up flash; effective range when sensitivity is set to 800 is approx. 50 cm–7.4 m/1.6 ft.–24.2 ft. (wide angle; note that lens may block flash at short ranges), 80 cm–2.7 m/2.6 ft.–8.8 ft. (telephoto) Flash compensation; –2 EV – +2 EV in increments of 1/3 EV
--------------	---

Flash mode	Auto, fill flash, off, slow sync (red-eye removal off); auto with red-eye removal, fill flash with red-eye removal, off, slow sync with red-eye removal (red-eye removal on)
-------------------	--

LCD monitor	3.0-in. (7.6 cm), 920k-dot color LCD monitor; frame coverage approx. 100%
--------------------	---

Movies	<ul style="list-style-type: none"> • FHD 1920×1080: 1080p, 60 fps • HD 1280×720: 720p, 60 fps • 640 640×480: VGA, 30 fps • HS 320×240: 150 fps • FHD 1920×1080: 1080p, 30 fps • HD 1280×720: 720p, 30 fps • HS 640×480: 80 fps • HS 320×112: 250 fps <p>Note: FHD, HD, and 640 movies are recorded with stereo sound.</p>
---------------	---

Input/output terminals

Digital input/output	USB 2.0 High-Speed; MTP/PTP
-----------------------------	-----------------------------

HDMI output	Micro HDMI Connector
--------------------	----------------------

Specifications

Power supply/other

- Power supply** • NP-48 rechargeable battery

Battery life (approximate number of frames that can be taken with a fully-charged battery)

Battery type	Approximate number of frames
NP-48 (type supplied with camera)	240

CIPA standard, measured in  (auto) mode using battery supplied with camera and SD memory card.

Note: Number of shots that can be taken with battery varies with battery charge level and will decline at low temperatures.

- Charging time** Approx. 140 minutes (+20 °C/+68 °F)

- Dimensions** (W × H × D) 100.0 mm × 58.5 mm × 33.3 mm/3.9 in. × 2.3 in. × 1.3 in.

- Shooting weight** Approx. 206 g/7.2 oz., including battery and memory card

- Camera weight** Approx. 187 g/6.5 oz., excluding battery, accessories, and memory card

- Operating conditions**
- **Temperature:** 0 °C – +40 °C/+32 °F – +104 °F
 - **Humidity:** 10–80% (no condensation)

Wireless transmitter

- Standards** IEEE 802.11b/g/n (standard wireless protocol)

- Operating frequency**
- **U. S. A., Canada, Taiwan:** 2,412 MHz–2,462 MHz (11 channels)
 - **Other countries:** 2,412 MHz–2,472 MHz (13 channels)

- Access protocols** Infrastructure

NP-48 rechargeable battery**Nominal voltage** DC 3.6V**Nominal capacity** 1010 mAh**Operating temperature** 0°C – +40°C/+32°F – +104°F**Dimensions (W × H × D)** 28.1 mm × 40.8 mm × 8.1 mm/1.1 in. × 1.6 in. × 0.3 in.**Weight** Approx. 18 g/0.6 oz.**AC power adapter****Rated input** 100V–240 V AC, 50/60 Hz**Input capacity** • **100 V:** 11.6 VA • **240 V:** 15.5 VA**Rated output** 5.0V DC, 1000 mA**Operating temperature** 0°C – +40°C/+32°F – +104°F**Weight** Approx. 32 g/1.1 oz.

Weight and dimensions vary with the country or region of sale.

■ Notices

- Specifications subject to change without notice; for the latest information, visit http://www.fujifilm.com/products/digital_cameras/index.html. FUJIFILM shall not be held liable for damages resulting from errors in this manual.
- Although the LCD monitor is manufactured using advanced high-precision technology, small bright points and anomalous colors may appear, particularly in the vicinity of text. This is normal for this type of LCD monitor and does not indicate a malfunction; images recorded with the camera are unaffected.
- Digital cameras may malfunction when exposed to strong radio interference (e.g., electric fields, static electricity, or line noise).
- Due to the type of lens used, some distortion may occur at the periphery of images. This is normal.

FUJIFILM

FUJIFILM Corporation

7-3, AKASAKA 9-CHOME, MINATO-KU, TOKYO 107-0052, JAPAN

http://www.fujifilm.com/products/digital_cameras/index.html

