

Supplement of

Distinct impacts of humidity on the ozonolysis of monoterpenes: insights into the multi-generation chemical mechanism

Shan Zhang et al.

Correspondence to: Lin Du (lindu@sdu.edu.cn) and Kun Li (kun.li@sdu.edu.cn)

S1. Calculation of equivalent aging days

The equivalent aging days can be calculated by $\text{Age (days)} = k \frac{O_{3\text{exp}}}{[O_3]} = k \frac{[O_3]_0 \times RT}{[O_3]}$, where $[O_3]_0$ is the initial ozone concentration in OFR, RT is the residence time, k is a constant coefficient which is equals to 1.03 and $[O_3]$ is the mean ozone concentration in the atmosphere for 1 day, estimated to be 6.05×10^{16} molec cm^{-3} s (Sbai and Farida, 2019).

S2. Materials

Limonene (>99%, TCI), Δ^3 -carene (>97%, Sigma Aldrich), methanol (Optima[®] LC-MS grade, Fisher Scientific), formic acid (Optima[®] LC-MS grade, Fisher Scientific), pressured nitrogen gas (99.999%, DEYI) were directly used for nitrogen-blowing without further purification. Ultrapure water with a resistivity of 18.2 M Ω cm was generated with a water purification system (Millipore, France).

S3. Calculation of the pure-compound saturation concentrations

The pure-compound saturation concentrations (C_0) of SOA from limonene and Δ^3 -carene have been predicted using the following nonlinear expression (Li et al., 2016):

$$\text{Log}_{10}C_0 = (n_C^0 - n_C) b_C - n_O b_O - 2 \frac{n_C n_O}{n_C + n_O} b_{CO}$$

The four free parameters n_C^0 , b_C , b_O and b_{CO} represent the carbon number of 1 $\mu\text{g m}^{-3}$ alkane, the carbon-carbon interaction term, the oxygen-oxygen interaction term and the carbon-oxygen nonideality respectively. The two independent variates n_C and n_O are the numbers of carbon and oxygen, respectively. Based on the calculated saturation mass concentration of organic aerosols, they can be classified into five groups (Donahue et al., 2012): extremely low-volatile organic compound (ELVOC; $C_0 < 3 \times 10^{-4} \mu\text{g m}^{-3}$); low-volatile organic compound (LVOC; $3 \times 10^{-4} < C_0 < 0.3 \mu\text{g m}^{-3}$); semi-volatile organic compound (SVOC; $0.3 < C_0 < 300 \mu\text{g m}^{-3}$); intermediate volatility organic compound (IVOC; $300 < C_0 < 3 \times 10^6 \mu\text{g m}^{-3}$) and volatile organic compounds (VOC; $C_0 > 3 \times 10^6 \mu\text{g m}^{-3}$).

Table S1. The number and intensity proportion of four groups.

Groups	Monomers	Dimers	Trimers	Tetramers
Number (L) ^a	242	162	122	116
Number (H) ^b	272	187	134	105
Intensity proportion (L) ^a	61.8%	25.7%	9.4%	3.1%
Intensity proportion (H) ^b	65.6%	24.4%	7.9%	2.0%

^a L means under low RH. ^b H means under high RH.

Table S2. Intensity and partitioning coefficient for products identified by MS (limonene).

	Molecular formula	Low RH		High RH		Partitioning coefficient	
		Absolute intensity	Relative intensity	Absolute intensity	Relative intensity	Low RH	High RH
Monomers	C ₁₀ H ₁₆ O ₂	9.01×10 ²	1.72×10 ⁻⁴	1.27×10 ³	1.42×10 ⁻⁴	0.01	0.02
	C ₉ H ₁₄ O ₃	1.49×10 ⁴	2.85×10 ⁻³	3.00×10 ⁴	3.33×10 ⁻³	0.02	0.05
	C ₁₀ H ₁₆ O ₃	4.99×10 ⁴	9.54×10 ⁻³	8.58×10 ⁴	9.55×10 ⁻³	0.05	0.10
	C ₉ H ₁₄ O ₄	1.29×10 ⁵	2.46×10 ⁻²	2.46×10 ⁵	2.73×10 ⁻²	0.13	0.25
	C ₁₀ H ₁₈ O ₃	1.21×10 ³	2.31×10 ⁻⁴	1.64×10 ³	1.82×10 ⁻⁴	0.05	0.10
	C ₉ H ₁₆ O ₄	7.60×10 ³	1.45×10 ⁻³	1.51×10 ⁴	1.68×10 ⁻³	0.13	0.25
	C ₁₀ H ₁₆ O ₄	1.28×10 ⁵	2.45×10 ⁻²	2.24×10 ⁵	2.49×10 ⁻²	0.24	0.41
	C ₉ H ₁₄ O ₅	1.28×10 ⁵	2.45×10 ⁻²	2.08×10 ⁵	2.33×10 ⁻²	0.58	0.76
	C ₉ H ₁₄ O ₃	1.49×10 ⁴	2.85×10 ⁻³	3.00×10 ⁴	-	0.02	0.05
	C ₈ H ₁₂ O ₄	6.71×10 ⁴	1.28×10 ⁻²	1.35×10 ⁵	-	0.07	0.15
	C ₁₀ H ₁₈ O ₂	2.62×10 ²	5.01×10 ⁻⁵	4.60×10 ²	5.12×10 ⁻⁵	0.01	0.02
	C ₉ H ₁₆ O ₃	7.20×10 ³	1.38×10 ⁻³	1.48×10 ⁴	1.64×10 ⁻³	0.02	0.05
C ₁₀ H ₁₄ O ₃	7.34×10 ³	1.40×10 ⁻³	1.34×10 ⁴	1.50×10 ⁻³	0.05	0.10	

	C ₉ H ₁₂ O ₄	3.49×10 ⁴	6.66×10 ⁻³	5.94×10 ⁴	6.61×10 ⁻³	0.13	0.25
	C ₁₀ H ₁₄ O ₅	4.00×10 ⁴	7.64×10 ⁻³	5.44×10 ⁴	6.06×10 ⁻³	0.71	0.85
	C ₉ H ₁₂ O ₆	1.25×10 ⁴	2.38×10 ⁻³	2.08×10 ⁴	2.31×10 ⁻³	0.94	0.97
	C ₁₀ H ₁₆ O ₆	-	8.32×10 ⁻³	7.12×10 ⁴	7.93×10 ⁻³	0.96	0.98
	C ₁₀ H ₁₈ O ₄	-	1.49×10 ⁻³	1.29×10 ⁵	1.44×10 ⁻³	0.24	0.41
	C ₉ H ₁₆ O ₅	1.40×10 ⁴	2.67×10 ⁻³	2.76×10 ⁴	3.08×10 ⁻³	0.58	0.76
	C ₁₀ H ₁₈ O ₆	-	1.39×10 ⁻³	1.31×10 ⁵	1.46×10 ⁻³	0.96	0.98
	C ₁₀ H ₁₆ O ₅	8.02×10 ³	1.53×10 ⁻²	1.49×10 ⁴	1.65×10 ⁻²	0.72	0.85
	C ₉ H ₁₄ O ₆	-	-	9.40×10 ⁴	1.05×10 ⁻²	0.94	0.97
	C ₁₀ H ₁₈ O ₅	9.05×10 ³	1.73×10 ⁻³	1.65×10 ⁴	1.84×10 ⁻³	0.72	0.85
	C ₉ H ₁₆ O ₆	-	-	1.41×10 ⁴	1.57×10 ⁻³	0.94	0.97
HOMs	C ₉ H ₁₄ O ₇	-	4.19×10 ⁻³	4.44×10 ⁴	4.95×10 ⁻³	1.00	1.00
	C ₁₀ H ₁₄ O ₇	8.75×10 ³	1.67×10 ⁻³	1.32×10 ⁴	1.47×10 ⁻³	1.00	1.00
	C ₁₀ H ₁₄ O ₁₁	-	-	3.68×10 ²	4.10×10 ⁻⁵	1.00	1.00
	C ₁₀ H ₁₄ O ₁₃	-	-	3.88×10 ²	4.32×10 ⁻⁵	1.00	1.00
	C ₉ H ₁₆ O ₇	7.71×10 ³	1.47×10 ⁻³	1.91×10 ⁴	2.13×10 ⁻³	1.00	1.00
	C ₁₀ H ₁₆ O ₇	1.63×10 ⁴	3.12×10 ⁻³	3.00×10 ⁴	3.35×10 ⁻³	1.00	1.00
	C ₉ H ₁₄ O ₈	-	-	4.12×10 ³	4.60×10 ⁻⁴	1.00	1.00
	C ₁₀ H ₁₈ O ₇	4.70×10 ³	8.99×10 ⁻⁴	8.90×10 ³	9.91×10 ⁻⁴	1.00	1.00
	C ₉ H ₁₆ O ₈	-	-	2.54×10 ³	2.82×10 ⁻⁴	1.00	1.00
	C ₁₀ H ₁₆ O ₈	3.63×10 ³	6.94×10 ⁻⁴	7.08×10 ³	7.67×10 ⁻⁴	1.00	1.00
Dimers	C ₂₀ H ₃₄ O ₄	-	-	4.98×10 ²	5.55×10 ⁻⁵	1.00	1.00
	C ₁₈ H ₃₀ O ₆	-	-	2.74×10 ³	3.04×10 ⁻⁴	1.00	1.00
	C ₁₈ H ₂₈ O ₇	-	-	1.53×10 ⁴	1.70×10 ⁻³	1.00	1.00
	C ₂₀ H ₃₀ O ₈	3.61×10 ²	1.97×10 ⁻³	-	1.40×10 ⁻³	1.00	1.00
	C ₁₈ H ₂₆ O ₈	1.29×10 ⁴	2.47×10 ⁻³	2.34×10 ⁴	2.62×10 ⁻³	1.00	1.00

Table S3. Δ^3 -carene-SOA identified under high RH in Fig. S3.

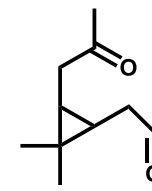
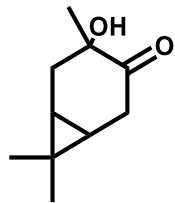
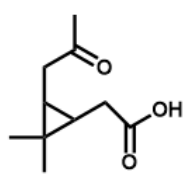
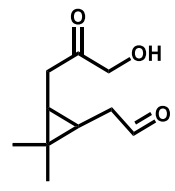
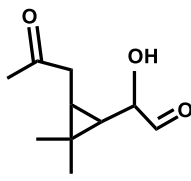
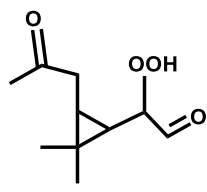
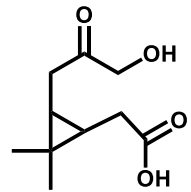
[M-H] ⁻	Theo. Mass	Error (ppm)	DBE	Suggested Formula	Molecular Structure
167.10657	167.107753	7.081	3	C ₁₀ H ₁₆ O ₂	
					
183.101733	183.102668	5.105	3	C ₁₀ H ₁₆ O ₃	
					
169.122233	169.123403	6.921	2	C ₁₀ H ₁₈ O ₂	
199.096239	199.097583	6.747	3	C ₁₀ H ₁₆ O ₄	
					

181.085655	181.087018	7.526	3	C ₁₀ H ₁₄ O ₃	
351.214938	351.217698	7.858	5	C ₂₀ H ₃₂ O ₅	
365.194982	365.196962	5.421	6	C ₂₀ H ₃₀ O ₆	
185.080938	185.081932	5.374	3	C ₉ H ₁₄ O ₄	

Table S4. Limonene-SOA under high RH identified in Fig. 3 and Fig. 4.

[M-H] ⁻	Theo. Mass	Error (ppm)	DBE	Suggested Formula	Molecular Structure
169.086288	169.087018	4.319	3	C ₉ H ₁₄ O ₃	
					
					
183.065329	183.066282	5.208	4	C ₉ H ₁₂ O ₄	
167.107219	167.107753	3.198	2	C ₁₀ H ₁₆ O ₂	
					

183.102508	183.102668	0.874	3	$C_{10}H_{16}O_3$	
					
					
185.081203	185.081932	3.943	3	$C_9H_{14}O_4$	
					
					
					
187.060122	187.061197	5.749	3	$C_8H_{12}O_5$	

199.096857	199.097583	3.644	3	C ₁₀ H ₁₆ O ₄	
					
					
185.117126	185.118318	6.441	2	C ₁₀ H ₁₈ O ₃	
187.096428	187.097583	6.172	2	C ₉ H ₁₆ O ₄	
201.075661	201.076847	5.896	3	C ₉ H ₁₄ O ₅	
					

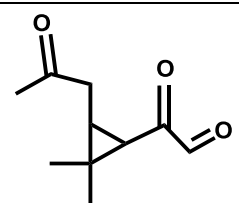
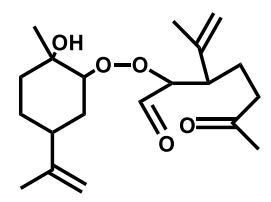
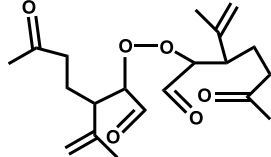
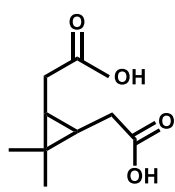
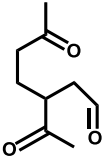
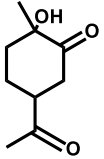
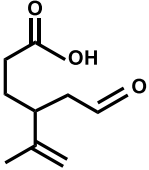
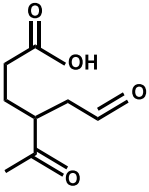
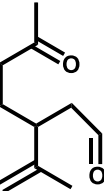
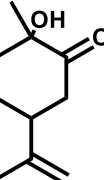
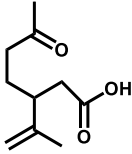
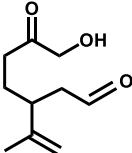
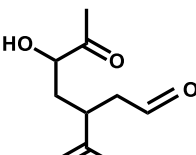
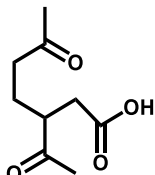
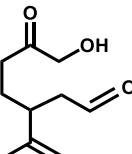
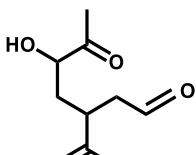
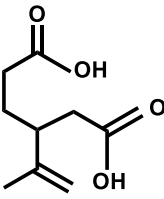
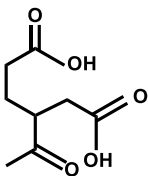
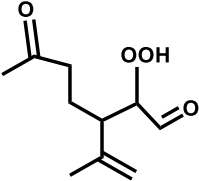
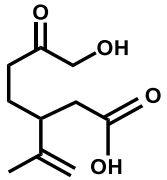
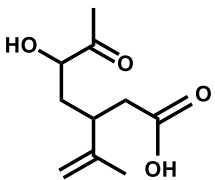
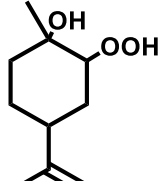
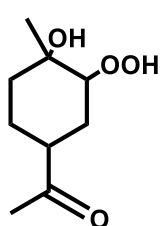
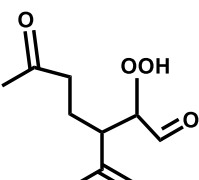
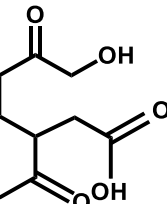
					
181.086015	181.087018	5.536	4	$C_{10}H_{14}O_3$	
337.237472	337.238433	2.851	4	$C_{20}H_{34}O_4$	
341.196189	341.196962	2.266	4	$C_{18}H_{30}O_6$	
355.17525	355.176227	2.749	5	$C_{18}H_{28}O_7$	
369.154689	369.155491	2.174	6	$C_{18}H_{26}O_8$	

Table S5. Intensity and partitioning coefficient for HOMs and dimers identified by MS (Δ^3 -carene).

	Molecular formula	Low RH		High RH		Partitioning coefficient	
		Absolute intensity	Relative intensity	Absolute intensity	Relative intensity	Low RH	High RH
HOMs	C ₁₀ H ₁₃ O ₁₁	3.41×10 ²	5.44×10 ⁻⁵	-	-	1.00	1.00
	C ₁₀ H ₁₅ O ₈	1.42×10 ³	2.26×10 ⁻⁴	8.31×10 ²	1.89×10 ⁻⁴	1.00	1.00
	C ₁₀ H ₁₇ O ₁₁	2.32×10 ³	3.70×10 ⁻⁴	1.61×10 ³	3.65×10 ⁻⁴	1.00	1.00
	C ₁₀ H ₁₇ O ₈	4.60×10 ²	7.34×10 ⁻⁵	-	-	1.00	1.00
Dimers	C ₂₀ H ₂₉ O ₆	1.25×10 ⁴	1.97×10 ⁻³	7.55×10 ³	1.71×10 ⁻³	1.00	1.00
	C ₂₀ H ₂₉ O ₈	6.99×10 ³	1.11×10 ⁻³	4.16×10 ³	9.44×10 ⁻⁴	1.00	1.00
	C ₂₀ H ₂₉ O ₁₀	3.62×10 ³	5.77×10 ⁻⁴	-	-	1.00	1.00
	C ₂₀ H ₃₁ O ₇	1.58×10 ⁴	2.51×10 ⁻³	7.45×10 ³	1.69×10 ⁻³	1.00	1.00
	C ₂₀ H ₃₁ O ₉	1.31×10 ⁴	2.09×10 ⁻³	8.76×10 ³	1.99×10 ⁻³	1.00	1.00
	C ₂₀ H ₃₁ O ₁₁	2.98×10 ³	4.76×10 ⁻⁴	-	-	1.00	1.00
	C ₂₀ H ₃₁ O ₁₃	5.11×10 ²	8.15×10 ⁻⁵	3.12×10 ²	7.09×10 ⁻⁵	1.00	1.00

Table S6. The experimental data and results of β -caryophyllene oxidation.

Exp.	[Precursor] (ppb)	[O] ₃ (ppm)	T (K)(K)	RH (%)	N _(14.1-735nm) ^a (no.cm ⁻³)	M _(14.1-735nm) ^b ($\mu\text{g m}^{-3}$)	D _(mean) ^c (nm)	SOA yield (%)
1	234.9	6.3	298	3.2	(2.3±0.1)×10 ⁶	168.2±13.8	49.9±2.5	9.4±0.8
2	255.3	6.4	298	58	(3.6±0.5)×10 ⁶	584.1±10.9	64.3±0.7	25.1±0.5

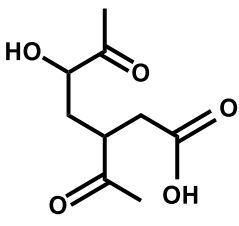
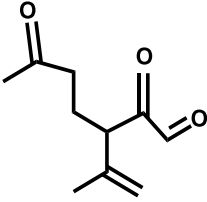
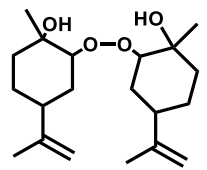
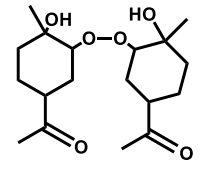
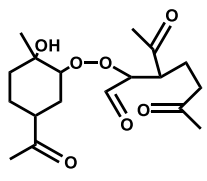
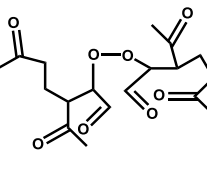
^a N_(14.1-735 nm) means the total particle number concentration from size 13.8 nm to 723.4 nm. ^b M_(13.8-723.4 nm) means the total particle mass concentration from size 13.8 nm to 723.4 nm. ^c D_(mean) means the particle mean diameter.

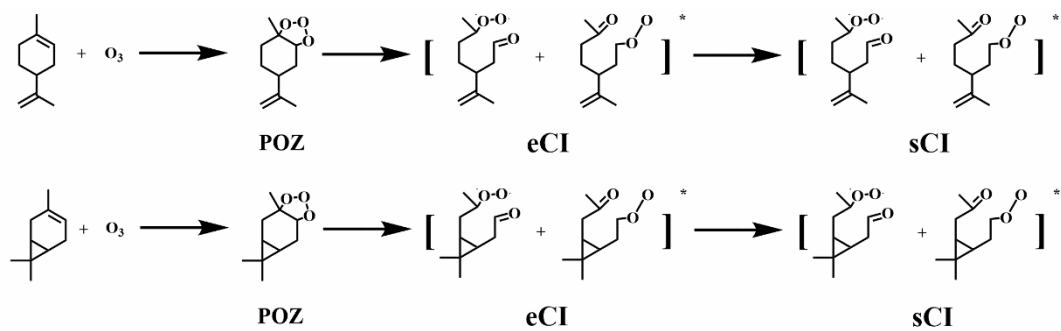

Fig S1. The formation of sCIs from the ozonolysis of limonene and Δ^3 -carene.

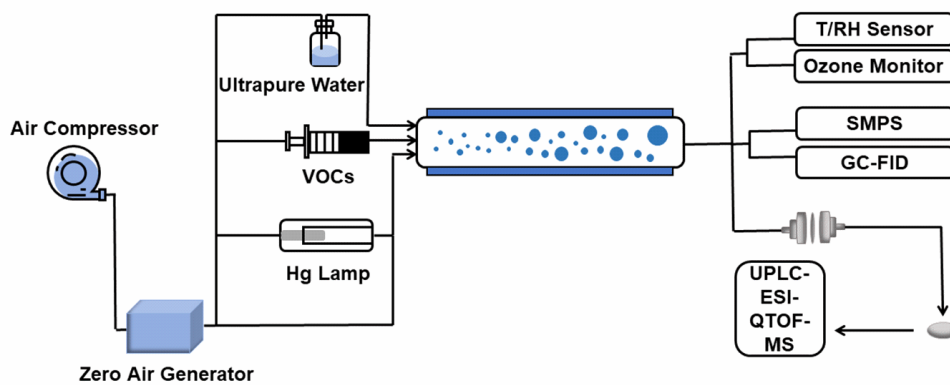

Figure S2. Schematic description of the experiment.

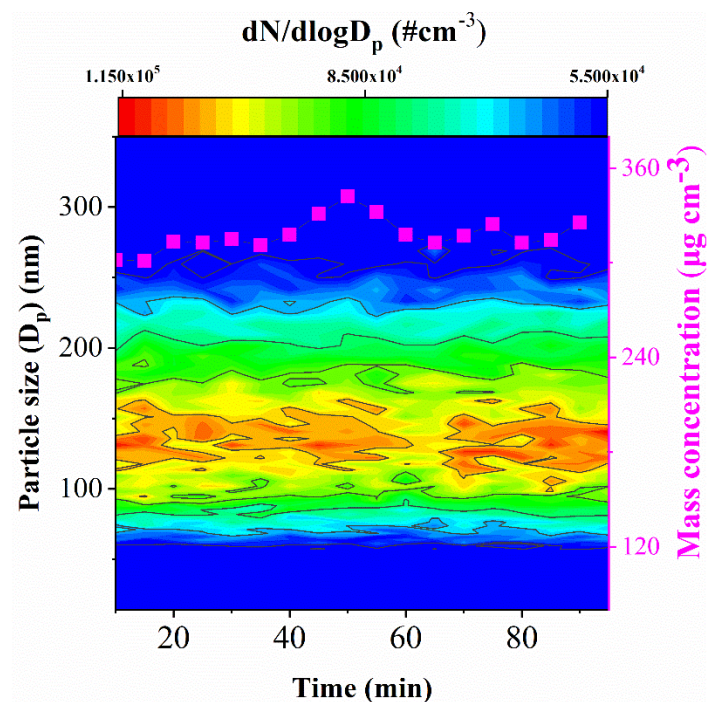

Figure S3. Time evolution of SOA size (electromobility diameter) and mass concentration obtained from Δ^3 -carene/ O_3 experiment (Exp. 11).

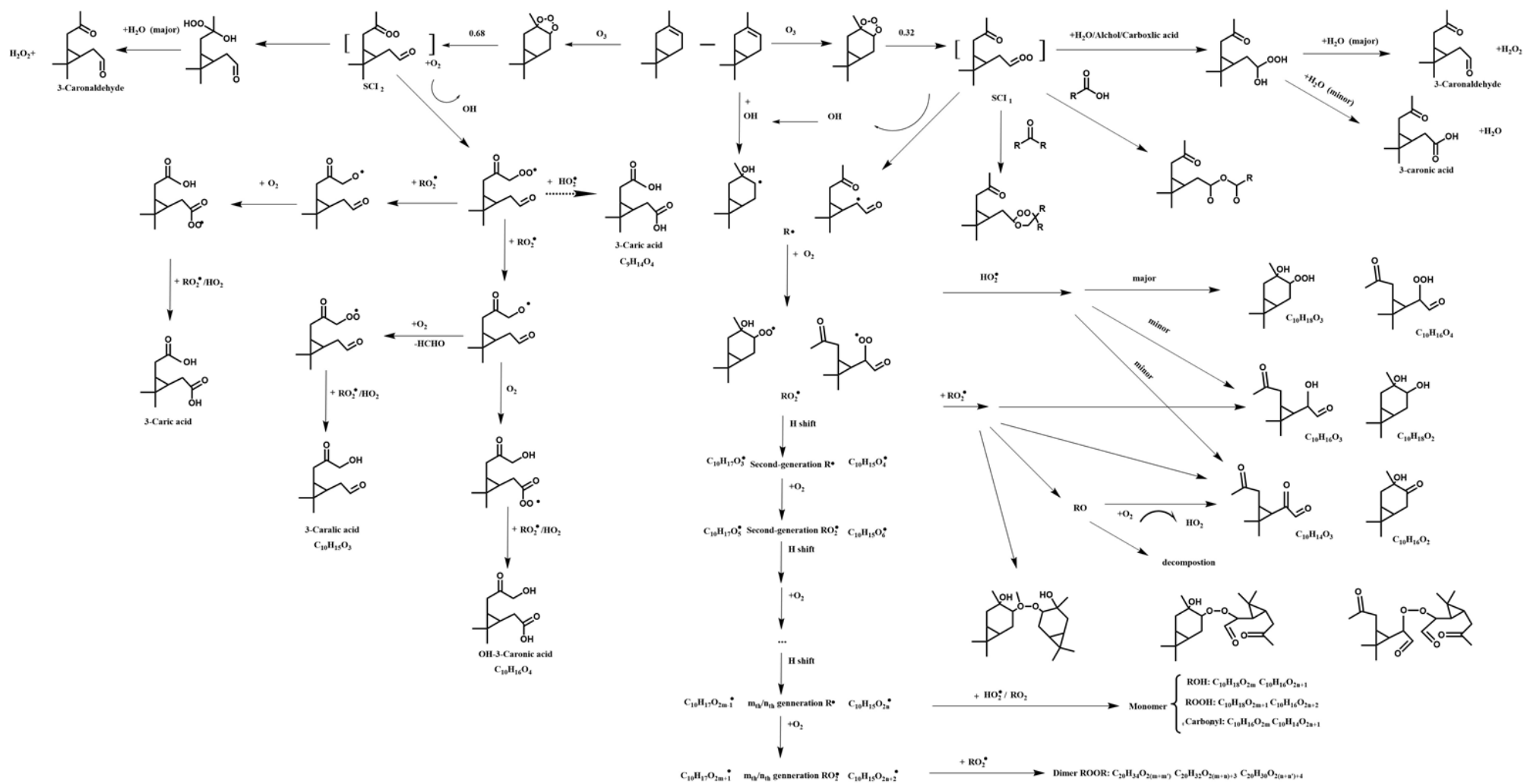

Figure S4. Proposed formation mechanisms for SOA formation from Δ^3 -carene ozonolysis under high RH.

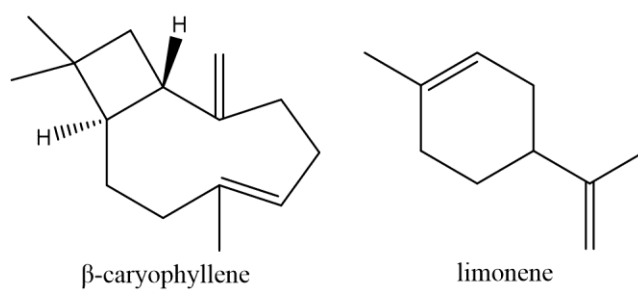

Figure S5. The molecular structure of β -caryophyllene and limonene.

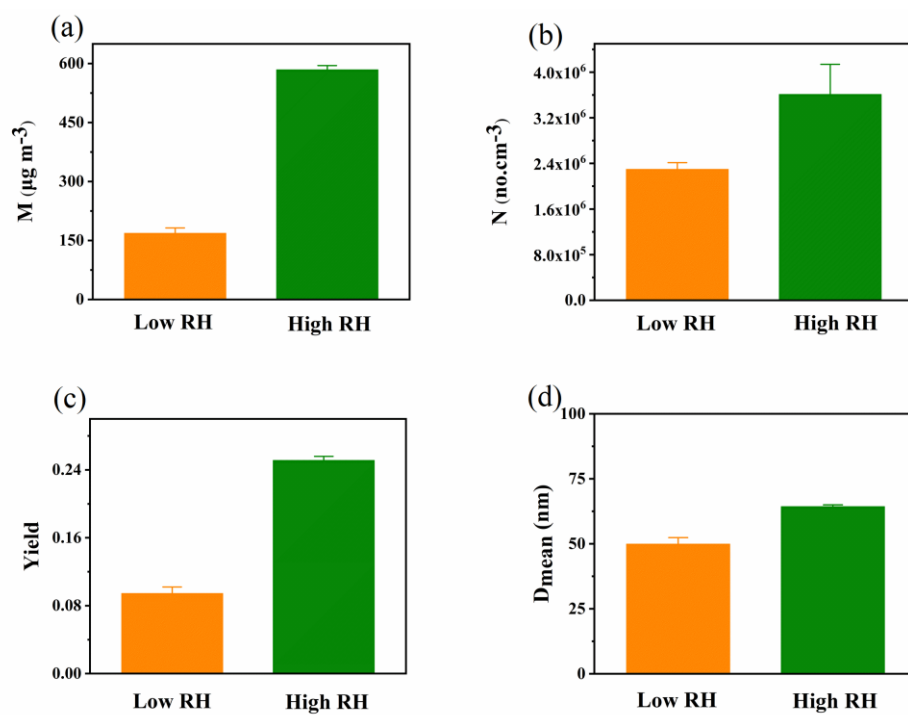

Figure S6. The SOA formation of β -caryophyllene under low and high RH (a) mass concentration (b) number concentration (c) SOA yield (d) mean diameter.

Reference

Donahue, N. M., Kroll, J. H., Pandis, S. N., and Robinson, A. L.: A two-dimensional volatility basis set - Part 2: Diagnostics of organic-aerosol evolution, *Atmos. Chem. Phys.*, 12, 615-634, <https://doi.org/10.5194/acp-12-615-2012>, 2012.

Li, Y., Poeschl, U., and Shiraiwa, M.: Molecular corridors and parameterizations of volatility in the chemical evolution of organic aerosols, *Atmos. Chem. Phys.*, 16, 3327-3344, <https://doi.org/10.5194/acp-16-3327-2016>, 2016.

Sbai, S. E. and Farida, B.: Photochemical aging and secondary organic aerosols generated from limonene in an oxidation flow reactor, *Environ. Sci. Pollut. Res.*, 26, 18411-18420, <https://doi.org/10.1007/s11356-019-05012-5>, 2019.