

CONF-8804224



# Lawrence Berkeley Laboratory

UNIVERSITY OF CALIFORNIA

## Accelerator & Fusion Research Division

Presented at the Budker Memorial Seminar, "International Seminar on Topics in High Energy Physics and Controlled Fusion," Novosibirsk, USSR,  
April 26-29, 1988

### The Two-Beam Accelerator and the Relativistic Klystron Power Source

A.M. Sessler

April 1988

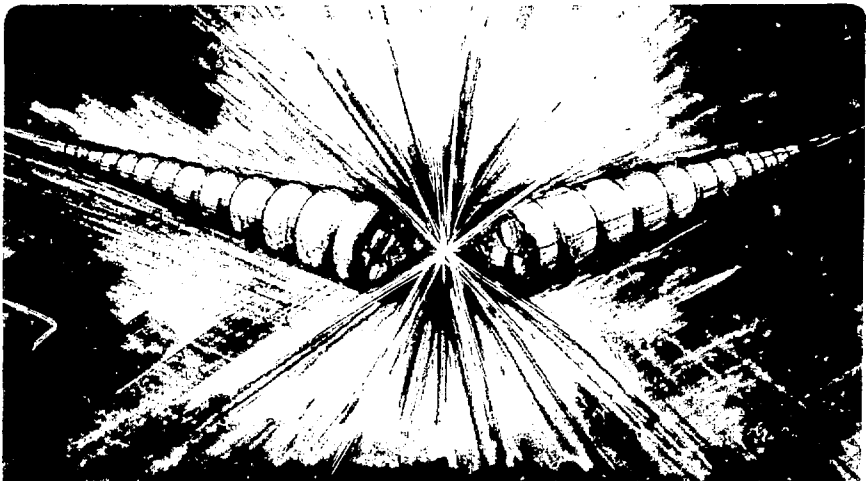
REPRODUCED FROM  
BEST AVAILABLE COPY

## The Two-Beam Accelerator and the Relativistic Klystron Power Source\*

Andrew M. Sessler

Lawrence Berkeley Laboratory  
University of California  
Berkeley, CA 94720, USA

### DISCLAIMER

This report was prepared as an account of work sponsored by an agency of the United States Government. Neither the United States Government nor any agency thereof, nor any of their employees, makes any warranty, express or implied, or assumes any legal liability or responsibility for the accuracy, completeness, or usefulness of any information, apparatus, product, or process disclosed, or represents that its use would not infringe privately owned rights. Reference herein to any specific commercial product, process, or service by trade name, trademark, manufacturer, or otherwise does not necessarily constitute or imply its endorsement, recommendation, or favoring by the United States Government or any agency thereof. The views and opinions of authors expressed herein do not necessarily state or reflect those of the United States Government or any agency thereof.

---

\* Work performed jointly under the auspices of the U.S. Department of Energy by Lawrence Livermore National Laboratory under contract W-7405-ENG-48 and by Lawrence Berkeley Laboratory for the Office of Energy under contract DE-AC03-76SF00098.

**MASTER**

zb

## The Two-Beam Accelerator and the Relativistic Klystron Power Source\*

Andrew M. Sessler

Lawrence Berkeley Laboratory  
University of California  
Berkeley, CA 94720, USA

### I. People

The Two-Beam Accelerator (TBA) was first proposed in 1982.<sup>1</sup> Currently, some of the concepts in the TBA are being studied by a joint SLAC/LLNL/LBL Collaboration. There are a great many workers who have been involved in the studies over the last five years and, in particular, in the very vigorous activity now engaged in by the collaboration. They are, at SLAC: M. Allen, K. Eppley, T. Lee, J. Lebacqz, G. Loew, T. Lavine, R. Miller, P. Morton, R. Palmer, W. K. H. Panofsky, R. Ruth, A. Vlieks, P. Wilson, R. Fowkes; at LLNL: D. Prosnitz, S. Yu, T. Scharlemann, W. Fawley, W. Barletta, G. Westenskow, T. Houck, W. Sharp, M. Teague; at LBL: J. Wurtele, D. Hopkins, R. Kuenning, E. Steinbach, D. Whittum, F. Selph, Y. Goren; and D. Yu (DULY Associates) and J. Haimson (Haimson Associates).

Prior to turning to the subject of this paper I want to make some remarks about the truly extraordinary man whom we are honoring at this seminar.

I first met Gersh Budker, here, in 1965. I was rather young then, and yet I had been invited -- along with perhaps only a half dozen other Americans -- to a very important seminar that was being held here on storage rings.

And that right away says something about Budker. He didn't invite lab directors and distinguished-people-who-once-were-active but rather he went for the active scientist. And that was true, also, right here, in his selection of members of the institute.

The conference was, as I said, very important for it set the frame work for serious work that next summer at SLAC leading the following year to the first international meeting on storage rings at Oray. Now, you know, all machines are colliders, but in those days the approach was novel and only worked on by a few groups in the world. At that time we had done much of the theoretical work

---

\* Work performed jointly under the auspices of the U.S. Department of Energy by Lawrence Livermore National Laboratory under contract W-7405-ENG-48 and by Lawrence Berkeley Laboratory for the Office of Energy under contract DE-AC03-76SF00098.

needed for proton colliders: RF theory, stacking, beam-beam limits and various instabilities. Very important experimental work was being done here, at Stanford, at Orsay, and at Frascati, on electron colliders.

Some very important advances lay, of course, in the future; especially on the technical side of making better, large, vacuum ion sources, etc. Some conceptual discoveries needed to be made and one of those was electron cooling. Oh yes, Budker made many inventions, but let me talk about that particular one. In order to construct good p-p storage rings one needed to damp phase space. We realized that in 1956 when we first saw the relevance of Liouville's theorem. And on - and - off for a decade we had tried to invent ways to eat the theorem. No luck. We were in a position to appreciate the importance of electron cooling! The concept is important in its own right (especially in nuclear) but, most importantly, it set us "thinking right".

The first time I heard of Budker was for his paper at the First International Accelerator Conference in 1956. His self-focused beam ideas, "Budker beams" is a marvelously original and imagination idea, I should, perhaps, have talked about how it has become used every day in our laboratory or, even about some work I am doing, just now, with self-focused beams. But, I'm not going to talk about Budker beams. Looking back to 1956, the concept certainly precipitated him into thoughts, and daily conversation, of accelerator physicists throughout the world.

Let me make a few remarks about my personal interactions with Gersh. I recall being welcomed into his home in 1965. And I recall some serious discussions about the Soviets and the Soviets economics systems and about world peace. And I shall never forget a wonderful picnic, some of you were there, at Lake Sevan, during the Tsakador Accelerator Conference. I ask you: How often in your life do you buy a lamb, cuddle it, have a group picture taken with the lamb as center piece, and then kill, cook over an open fire, and eat the fellow? Budker seemed to enjoy every bit of it.!

My subject today is the Two-Beam Accelerator, which is a concept for producing every-better colliders. I can only think that Budker -- if he were here -- would have been intensely interested, and probably made many useful suggestions, on this subject. Yes, we miss him! Perhaps, then my subject is appropriate for a memorial seminar. Let me turn to it.

## II. TBA Concepts

The Two-Beam Accelerator (TBA) concept is illustrated in Fig. 1. There are two versions of a TBA. One employes a free electron laser (FEL) and thus makes the TBA/FEL, which is illustrated in Fig. 2. The second version employes a branched beam sent through "transfer cavities" as in a klystron. This version, the TBA/RK, relativistic klystron is illustrated in Fig. 3.

A number of review papers have been written on the TBA.<sup>2,3,4</sup> Present power sources for linacs (klystrons) give 50 MW/tube and power the linac to 17 MV/m (SLAC). Future colliders will require very much higher gradients, say (about) 200 MV/m and much more powerful sources, say (about) 2 GW/tube. Except for FEL's, Gyroklystrons, Gyratons, or RKs there seems little likelihood of generating the requisite power with other sources; in this paper, because of the convenience of i.e. - acceleration and hence of repetitive use, we focus upon the FEL and the RK.

Even with this restriction to two possible methods of energy extraction from the drive beam there are two (at least) methods of restoring energy to the drive beam; namely with induction units or with superconducting cavities. The people at CERN are pursuing the RK/ superconducting; cavity; we have explored induction units and it is on the later that I focus in this paper.

One can note that the RK has interaction between the drive beam and the longitudinal component,  $E_{||}$ , of the microwave field. In the FEL the interaction is with the perpendicular component,  $E_{\perp}$ , of the microwave field. Consequently the RK must have "bumpy" walls (of the order of the wavelength of the rf,d). The FEL has smooth walls, but is "overmoded". At small wavelengths one must employ an FEL, at long wavelengths a RK is clearly superior. The cross over point is not known; the CERN people hope to use a RK at  $\lambda \approx 1$  cm, and we are studying RK at  $\lambda = 2.5$  cm and  $\lambda = 1.7$  cm (in the future).

The choice of frequency depends, of course, strongly upon the properties of the collider. Some of the elements which enter these considerations are shown in Table I. Attention has focused upon the range of 10 GHz to 30 GHz.

### III. ELF

When originally the TBA was proposed, in 1982, no high-powered FEL had been yet made. Since that time the ELF Facility at Livermore has produced more than 1.0 GW peak power at 35 GHz.<sup>5,6</sup> Output from ELF is shown in Fig. 4, the group also studied special harmonics and temporal harmonics produced by ELF. These are displayed in Figs 5 and 6.

### IV. Steady State FEL

The ELF facility showed that an FEL is a prodigious source of power, but then it is necessary to ask if an FEL can be operated repeatedly; i.e. in "steady state", this has been studied closely and requires tapering between the induction units.<sup>7</sup> If the bucket area is kept sensibly constant; i.e. as much power is removed as is generated, then the FEL can be run forever without any growth in synchrotron phase space occupied by particles as is shown in Fig. 7. On the other hand, anyone particle has the rather complicated trajectory shown in Fig. 8. The net result of adding up many particles has the good result shown in Fig. 7.

## V. Problems

As we see it, there are four problem areas associated with the TBA/Fel. The first is the generation of sidebands, the second is phase control of the microwaves, the third is rf manipulation, and the fourth is transverse effects in the drive beam.

Sidebands appear at the desired frequency,  $\omega_0$  increased or decreased by the synchrotron frequency  $\omega_s$ . One can have undesirable gain of the sidebands as is shown in Fig. 9. The sidebands are driven by slippage between the microwave pulse, which moves at the group velocity,  $v_g$ , and the average electron beam longitudinal velocity  $v_{||}$ .

In fact, the position of sidebands is given by

$$[K \pm \Delta k + k_w] Z - (\omega \pm \Delta\omega) t = k_{\text{syn}} Z,$$

where  $k_w$  is the wiggler wave number and  $k_{\text{syn}}$  is the synchrotron wave number. Since  $z = v_{||} t$  and the resonance condition is

$$\omega = (k + k_w)v_{||},$$

we have

$$\Delta\omega = \frac{k_{\text{syn}}c}{1 - v_{||}/v_g}$$

where we have used

$$\Delta\omega = \frac{d\omega}{dk}(\Delta k) = v_g \Delta k.$$

The formula for  $\Delta\omega$  means that by varying  $v_{||}/v_g$  we can "move around"; and hence control the sidebands. An experiment has demonstrated this ability.<sup>8</sup> The problem seems "under control", but making  $v_{||} = v_g$  is a design restraint on a TBA.

Phase variation comes about because small error in low-energy beam current makes, after a while, an error in rf phase. (Just like in klystrons) This has been studied analytically and by 1D numerical simulations.<sup>9,10</sup> We have considered a number of possible corrections.

1. "Feed ahead": Very little time.
2. "Regular": Must process and amplify signal.  
Takes = 10-ns. Probably unstable.

3. Correct energy. Only need  $\Delta\gamma = .001$ , but how to do? Phase spread of particles in the FEL is 2 radials and the spread in  $\Delta\gamma$  is much greater than the desired shift in  $\Delta\gamma$ .
4. Mix clock with RF and get instantaneous change in amplitude and hence in phase after a bit. But need a lot of power in clock.

We have even considered rather exotic things:

Perhaps:

Ferrite, Ferro-electronics, Electro-optics (lithium niobate)  
can be employed to make an automatic phase-control system.

Clock

- Mix FEL rf wave with clock so as to get a signal proportional to phase.
- Apply rectified signal to above materials and change the rf phase velocity; i.e., change the rf phase in a bit.

Maybe can employ the fact that amplitude is related to phase in an FEL to make a system where  $v_p$  is level sensitive.

Perhaps one of these methods can be made practical. Bearing that we have adopted a "brute force" solution, which is shown in Fig. 10 and described in the literature.<sup>11</sup> The loss in efficiency due to this effect appears acceptable.

Microwave manipulation requires the removal of microwaves from the FEL and efficiently transmitting microwaves across the induction cells. We have not yet done very much work on the last problem. The first has been studied by designing and constructing the "septum coupler" shown in Fig. 11.<sup>12,13</sup> Tests with the septum coupler showed the following:

### 1. Power Division and Left-Right Symmetry

Symmetry:	OK
Power Division	Second septum-pair output low by ~3X; tapering too abrupt

### 2. FEL Output Phase, Mode and 3rd Harmonic Content

Approximately unchanged by presence of septum coupler

### 3. Arcing Threshold in Septum Coupler

Outside Wiggler:  $P_{\text{input}} = 75\text{MW}$   
 $P_{1,2,3,4} = 7\text{-}45\text{ MW range}$

Inside Wiggler:  $P_{\text{input}} = 600\text{-}800\text{ kW}$   
 $P_{1,2,3,4} = 100\text{-}300\text{kW range}$

We have only had the opportunity to perform the limited tests summarized above. Clearly we need to do better for a TBA.

As far as transverse effects in the drive beam are concerned, we have studied the resistive wall effect. This work has not yet been published so I describe it here in detail.<sup>14</sup> The physical situation is shown in Fig. 12. We assume the wall has conductivity  $\sigma$ .

Beam center of mass moves vertically an amount  $\xi(z,t)$

$$\frac{\partial^2 \xi(z,t)}{\partial t^2} + \omega_\beta^2 \xi(z,t) = \Omega^{5/2} \int_{-\infty}^t \frac{\partial \xi}{\partial t'}(z,t') \sqrt{t-t'} dt'$$

where

$$\Omega^{5/2} = \frac{\omega_p^2}{\gamma t_D^{1/2}} \sqrt{\frac{4}{\pi} \left(\frac{a}{b}\right)^2}$$

$\omega_\beta = \text{betatron (angular) frequency} = \frac{2 \times c}{\lambda_\beta}$

$$t_D = \frac{4\pi\sigma b^2}{c^2}$$

Growth with typical parameters ( $I = 2\text{ kA}$ ,  $20\text{ nsec pulse}$ ,  $\sigma = 10^{16}\text{ sec}^{-1}$ ,  $\lambda_w = 27\text{ cm}$ ,  $a = 0.6\text{ cm}$ ,  $b = 1.5\text{ cm}$ ,  $\gamma = 22.8$ ) is a factor of 9.7 in 100 meters.

Periodic variation in  $\gamma$  makes only a small reduction in the growth.

However the Landau damping, from a spread in  $\gamma$  gives a large reduction of the growth. A few percent in  $\Delta\gamma/\gamma$  is adequate to stabilize the instability and presumably arises from the spread within a bucket.

However synchrotron oscillations will greatly reduce the Landau damping. To study this we made a model study of the equation.



$$\frac{d^2x_j}{dt^2} + \omega_\beta^2 (1 + A_j \cos \Omega_g t) x_j = i \left( \frac{k}{N} \right) \sum_j x_j$$

Run N = 10 particles

$$\text{Compute Moment} = \sum_j |x_j| / N$$

Vary:  $\left( \frac{\Delta f}{f} \right)$  [related to spread in  $A_j$ ]

$$\frac{\Omega_s}{\omega_\beta} \quad \text{[synchrotron/betatron]}$$

$\frac{\Omega_s}{\omega_\beta}$	$\frac{\Delta f}{f}$	Moment	Comments
0	0	15.4	Instability
0	0.25	0.11	Landau damping
0.25	0	15.4	} Even $\Omega_s \sim 1/4 \omega_\beta$ requires $(\Delta f/f)$ to be <u>very</u> large
0.25	0.25	13.5	
0.25	0.50	9.2	
0.25	1.0	2.2	

The restriction on  $\Omega_s$  is severe and we do not yet know if we can find a set of parameters consistent with the requirement for transverse stability of the drive beam.

## VI. The TBA/RK

The TBA/RK has the essential elements shown in Fig. 13. There are, of course, a number of physics and technology issues which must be addressed. They can be categorized as

- RF Power Extraction/Transfer
- Surface Breakdown levels
- Output Coupling
- Beam Apertures
- Phase and Power Stability
- Beam bunching at High Energies and High Currents

Dynamics of the Driving Beam  
Transverse Beam Dynamics  
Longitudinal Beam Dynamics  
High Brightness Electron Gun for H.E. Beam Line  
High Gradient Accelerator Structures

Beam dynamics is an especially important aspect and we can say a bit about that:

1. Longitudinal beam dynamics:  
Issue: energy extraction with high efficiency
2. Transverse beam dynamics:  
Issue: Control of beam breakup (BBU) and resistive wall instabilities

Proposed solutions:

- (a) Energy spread in "buckets"
- (b) Staggered-tuning of transverse cavity-modes.

The "proposed solutions" are based on considerable (but still unpublished) numerical simulation work.

## VII. The RK Power Source

It is possible, of course, to "back off" from the TBA concept and arrive at an intermediate device which can still be quite interesting in its own light. In Fig. 14 we show three possible versions of the RK. To date, experimental attention has focused on the first version.

## VIII. RK Experiments

We have, to date, performed three experiments using the ARC Facility at LLNL. A view of this facility is shown in Fig. 15, the electron beam is 40 nsec, 1kA, and 1 MeV. The first experiment was at 8.57 GHz. with a klystron (previously built). shown in Fig. 16. A view of the klystron in place is shown in Fig. 17. Output is shown in Fig. 18. A peak power of 75 MW, corresponding to an efficiency greater than 50% was achieved, consistent with numerical simulations. This peak power corresponds to a peak surface field (in the output cavity) of 220 MV/m. No signs of breakdown were seen.

A second experiment had an input of  $\sim 2$  MW of power at 5.7 GHz. The output studied was at 11.48 Hz. A schematic of the device is shown in Fig. 19; and in Fig. 20 we show a picture of it. The rf output is shown in Fig. 21. One can see that at high input power the pulse is narrow in shape. This phenomena is not fully understood yet. (We have many theories, but have not yet had time to study the subject experimentally). Clearly the pulse must be made flat for the device to be useful.

A third experiment was with an 11.4 GHz klystron built especially for use at ARC (note the longer length than in the 8.5 GHz klystron). A schematic of the device is shown in Fig. 22, and recent results in Fig. 23. Again, we do not understand (yet) the reason behind the pulse shape.

### IX. Accelerating Structures

We have constructed a number of different high-gradient structures by means of two different techniques. (The choice between them depends upon trade offs among the ease of manufacture, reproducibility, and cost, none of which has been explored.) Fig. 24 shows an accelerating structure fabricated using a brazing technique that is effective even for small parts; Fig. 25 shows a section of an accelerating structure made by an electroforming technique. In the latter case, first an aluminum mandrel (above) is machined, then copper is deposited over the mandrel, and finally the mandrel is dissolved by caustic solution. The resulting structure (below) satisfies tolerance requirements on its inside, which is the only part that matters. (The holes are for pumping; i.e., the whole structure is put within an outer vacuum jacket.)

On 11.4 GHz structure has been made by the brazing technique. A photo of the pieces from which it is made is shown in Fig. 26. To date the assembled structure has been driven to an accelerating gradient of 100 MV/m, and, then, to 130 MV/m, but with sizeable ( $\geq 1$  A) dark current.

### X. Conclusion

The TBA/FEL involves an expensive structure, phase control is a problem, one must make  $v_g = v_{ph}$ , and one must get the microwaves out of the FEL and across the induction gaps. The TBA/RK involves a less expensive structure and phasing is automatic. But one must create intense bunches and maintaining these bunches (longitudinally and transversely) is a problem.

All-in-all the TBA seems worth of continued study. Power sources are a logical step towards a TBA and are of interest in their own right.

## REFERENCES

1. A. M. Sessler, "The Free Electron Laser as Power Source for a High Gradient Accelerator Structure" Proc. of the Workshop on Laser Acceleration of Particles, 1982, AIP Conf. Proc. 91, 154 (1982).
2. D. B. Hopkins, J. W. Wartele, and A. M. Sessler, "The Two-Beam Accelerator", Nucl. Instr. and Methods 228, 15, (1984).
3. D. B. Hopkins and A. M. Sessler, "The Two-Beam Accelerator", Proc. 1986 Linear Accelerator Conference, June 2-6, 1986, SLAC., 385 (1986).
4. A. M. Sessler and S. S. Yu, "Relativistic Klystron Version of the Two-Beam Accelerator", Phys. Rev. Lett., 58 2439 (1987).
5. T. Orzechowski, et. al., "Microwave Radiation from a High-Gain Free Electron Laser Amplifier" Phys. Rev. Lett. 54, 889, (1985).
6. T. Orzechowski et. al., "High Efficiency Extraction of Microwave Radiation From a Tapered Wiggler Free Electron Laser", Phys. Rev. Lett. 57, 2172 (1986).
7. A. M. Sessler and E. J. Sternback, "A Steady-State FEL: Particle Dynamics in the FEL Portion of a Two-Beam Accelerator" Proc. of the 7th Intl. FEL Cong., Nucl. Instr. and Methods in Phys. Res. A250, 464 (1986).
8. J. Masud, et. al., "Sideband Control in a Millimeter Wave Free Electron Laser", Physical Rev. Lett. 58, 763 (1987).
9. R. W. Kuenning, A. M. Sessler, and J. W. Wartele, "Phase and Amplitude Considerations for the Two-Beam Accelerator", Proceedings of the Second Workshop on the Laser Acceleration of Particles, Malibu, Jan. 1985, Am. Inst. Phys. Conf. Proc. 130, 324, (1985).
10. R. W. Kuenning, A. M. Sessler, and E. J. Sternback, "Radio Frequency Phase in the FEL Section of a TBA", Proc. of Symposium on Advanced Accelerator Concepts, Madison, Aug. 1986, Am. Inst. Phys. Conf. Proc. 156, 371 (1987).
11. Y. Goren and A. M. Sessler, "Phase Control of the Microwave Radiation in Free Electron Laser Two-Beam Accelerator", Proc. of the Workshop on New Developments in Particle Acceleration Techniques, Orsay, June 1987.
12. D. B. Hopkins, et. al., "High-Power 35 GHz Testing of a Free-Electron Laser and Two-Beam Accelerator Structures", Proc. of the SPIE High Intensity Laser Processes Conf. 664, 61, Quebec City, Canada, June 2-6, 1986.

13. D. B. Hopkins, et. al., "Fabrication and 35 GHz Testing of Key Two-Beam Accelerator Components", Proc. of the IEEE Particle Accelerator Conf., May 16-19 1987.
14. D. Whittum -- Private communication.

**Table 1.** Considerations in the choice of frequency for a collider. Attention is devoted to the 10- to 30-GHz range.

Acceleration gradient	$\sim f^{7/8}$	(Want high frequency)
Peak power	$\sim f^{1/2}$	(Want high frequency)
Average power	$\sim f^{-2}$	(Want high frequency)
Efficiency		(Want high frequency)
Structure fabrication complexity		(Want low frequency)
Wake-field effects	$W_L \sim f^2$ $W_T \sim f^3$	(Want low frequency)

## FIGURE CAPTIONS

- Fig. 1. Schematic of a two-beam accelerator (TBA). The low-energy drive beam provides power to the high-energy ( $\approx$  TeV) beam. The hoppers are necessary for the relativistic klystron (RD) version which also requires the induction accelerator to have higher energy ( $\sim 50$  MeV) than in the free electron laser (FEL) version. the later requires wigglers, however.
- Fig. 2. An artist's drawing of the free-electron laser (FEL) version of the two-beam accelerator (TBA). In this version, microwaves are generated from the drive beam by FEL action.
- Fig. 3. An artist's drawing of the relativistic klystron (RD) version of the two-beam accelerator (TBA). In this version, Microwaves are generated from the drive beam by RK action in eh (small) transfer cavities.
- Fig. 4. Data taken on the free-electron laser (FEL) at Lawrence Livermore National Laboratory operating at 35 GHz. [5,6]. The undulator period is 10 cm, there are 30 periods, and other parameters are given in the figure.
- Fig. 5. Modes (spacial) produced by ELF.
- Fig. 6. Third harmonic data, and simulation results, for ELF.
- Fig. 7. Longitudinal phase space in a TBA with a 2m period. No decrease in phase density is obtained over hundreds of meters.
- Fig. 8. This shows the actual phase space trajectory of an electron in a TBA. The trajectory begins at the top of the picture. The dashed vertical lines indicate when the electron passes through an induction unit. The numbers indicate the order of the jumps.
- Fig. 9. Two -dimensional simulation of a 20m section of a TBA (2m period).
- Fig. 10. A scheme for correcting the phase of the microwaves in a TBA.
- Fig. 11. A picture of the "septum coupler" envisioned as a power remover from the FEL section of a TBA.
- Fig. 12. Geometry, and coordinates, for studying the transverse resistive wall effects.
- Fig. 13. Essential elements in the TBA/RK.

- Fig. 14. There are three versions of the RK which can be considered. (The same is true for an FEL.) The first is the only one to receive experimental attention to date.
- Fig. 15. An overview of the ARC Accelerator.
- Fig. 16. A schematic of the 8.57 GHz klystron used at ARC.
- Fig. 17. The 8.57 GHz klystron installed at ARC.
- Fig. 18. The rf output, from the 8.57 GHz klystron. The "SLAC" points were taken with an ordinary power supply.
- Fig. 19. Schematic of the subharmonic drive experiment.
- Fig. 20. The subharmonic drive experiment. The input is through the larger waveguide (5.76Hz) and the output is through the smaller guide (11.4 GHz).
- Fig. 21. Output from the subharmonic drive experiment.
- Fig. 22. Schematic of the 11.4 GHz klystron.
- Fig. 23. Output recently achieved at the 11.4 GHz klystron. The triangular pulse shape is not yet understood.
- Fig. 24. A section of a 35-GHz, slow-wave, high-gradient, accelerating structure fabricated by a brazing technique. (The scale is in inches.)
- Fig. 25. A section of a 35-GHz accelerating section made by an electroforming technique.
- Fig. 26. Pieces for the 11.4 GHz high-gradient acceleration structure before brazing.



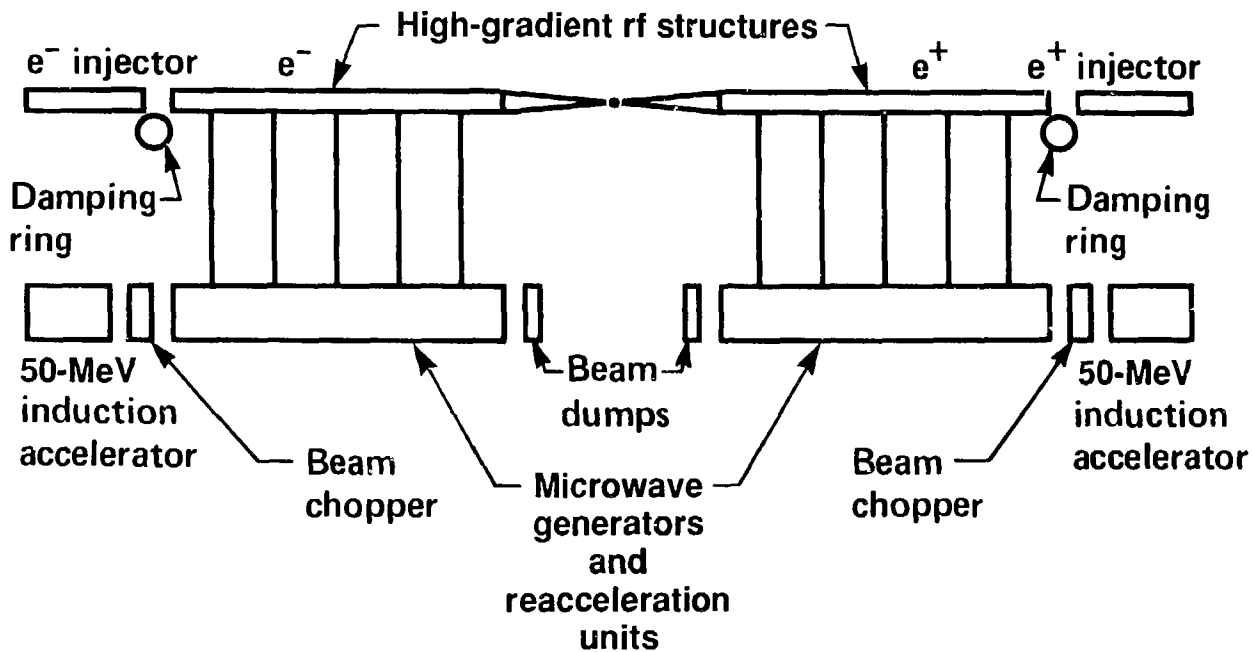

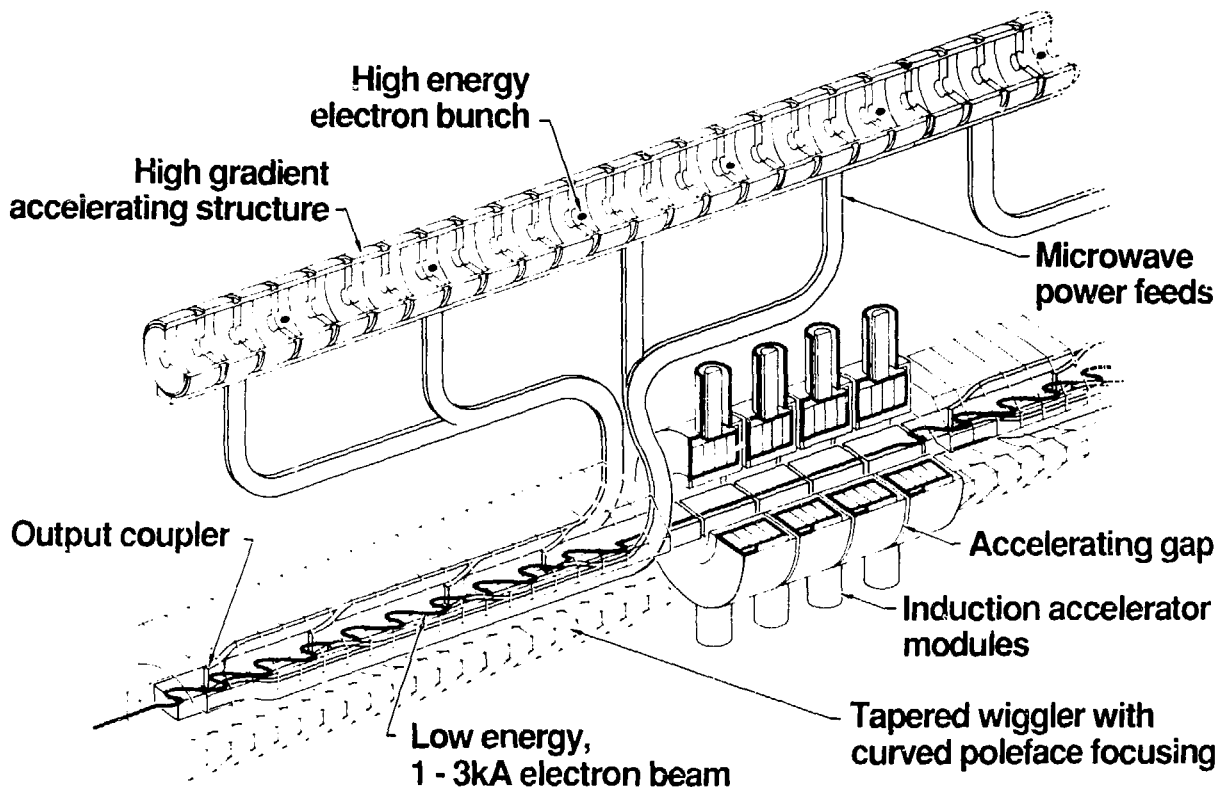

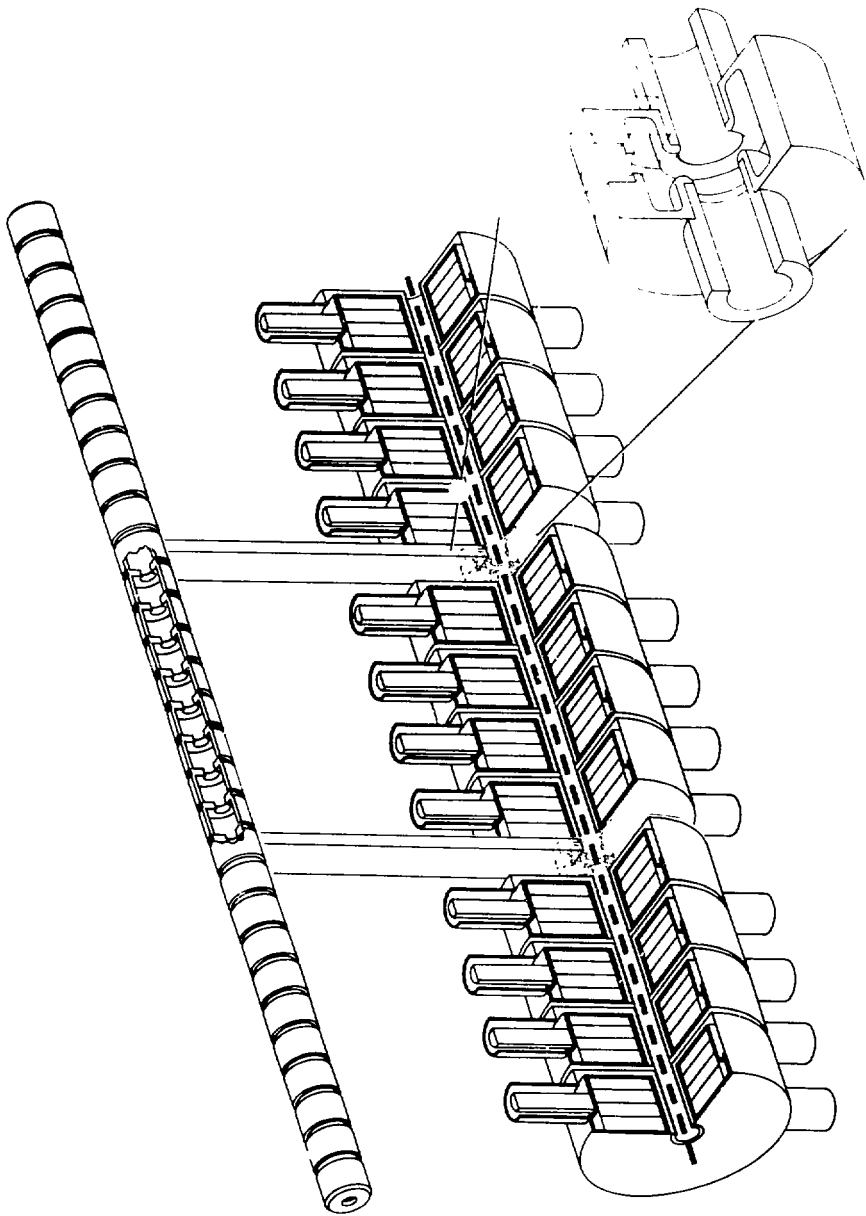

**Electron beam current  
(250A/div)**

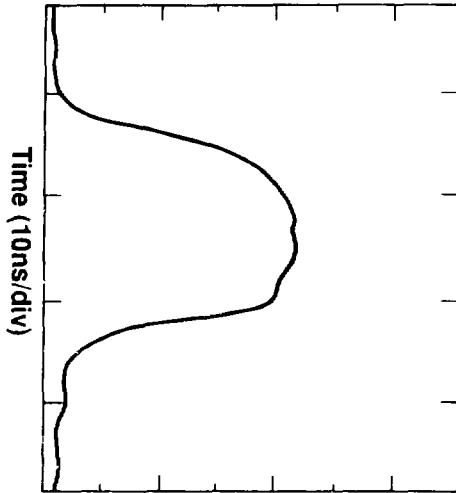

**Crystal detector response  
(0.5 GW/div)**

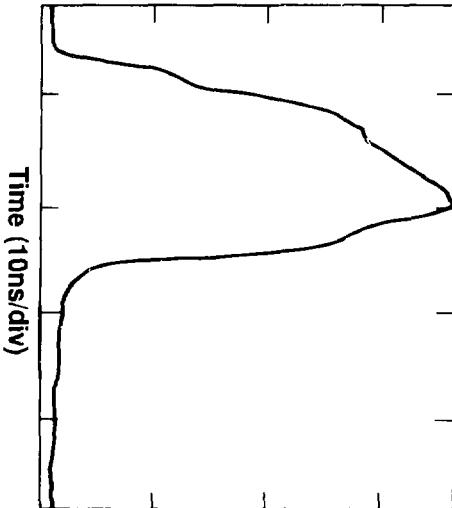

$B_w = 3.80 \text{ kG}$

▲  $TE_{01}$

●  $TE_{21} + TM_{21}$

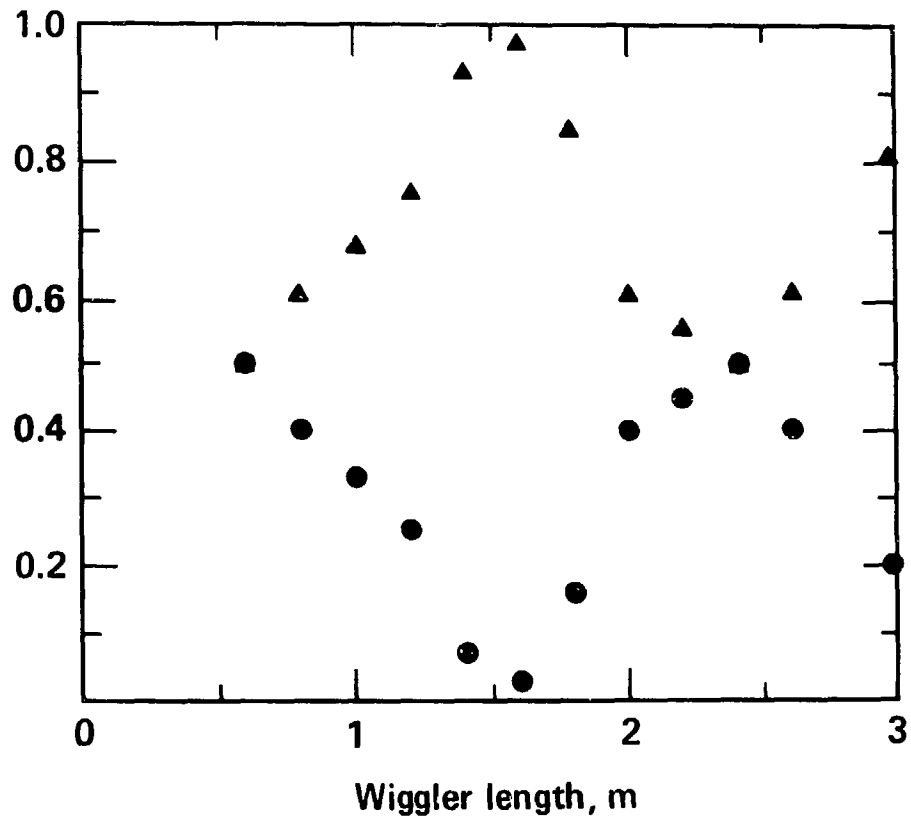

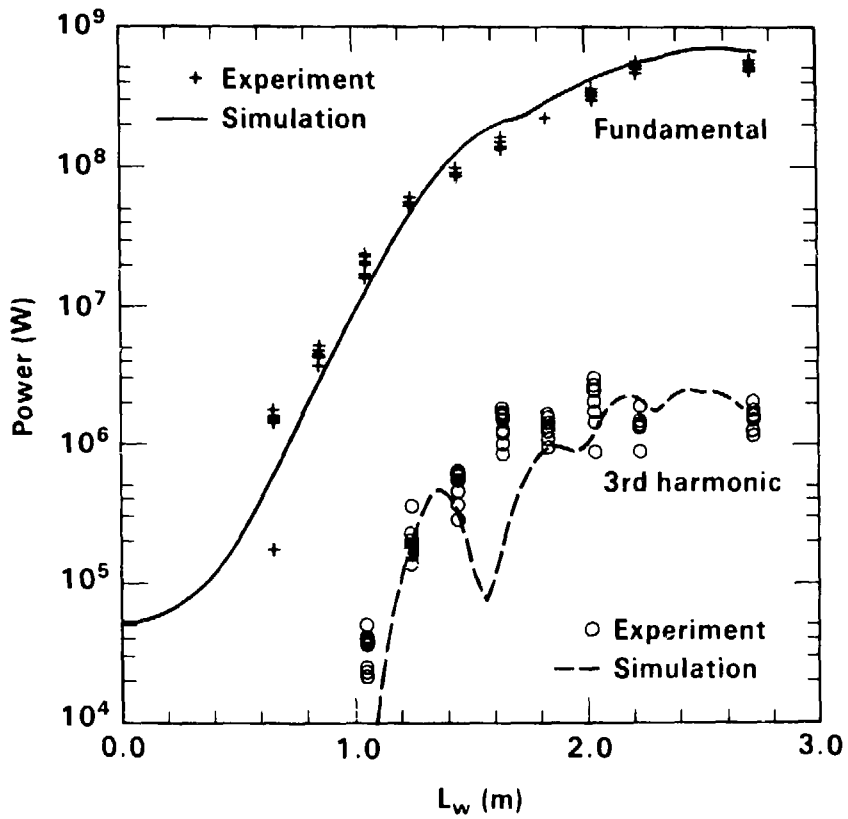

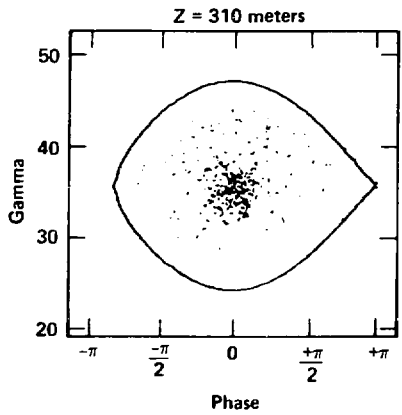
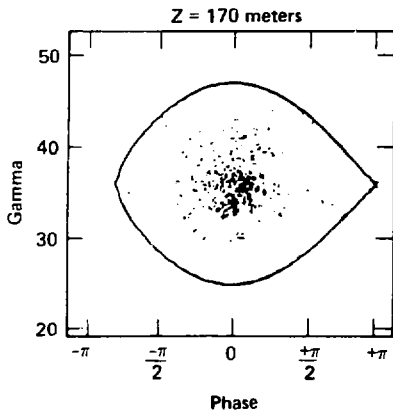
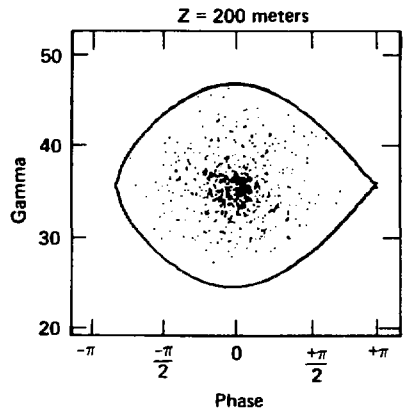
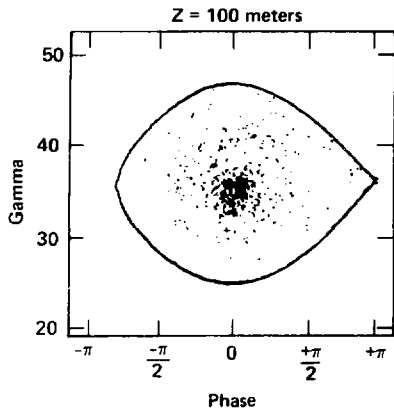

Trajectory

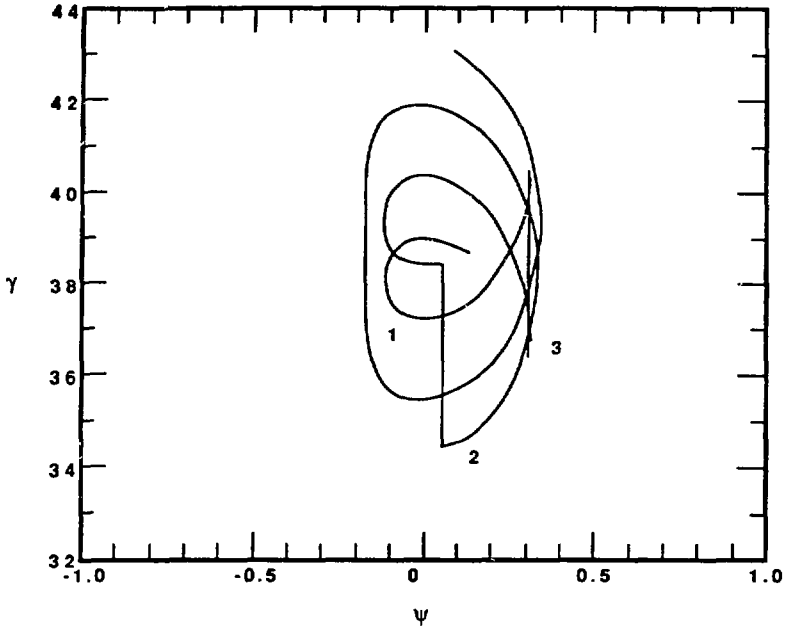



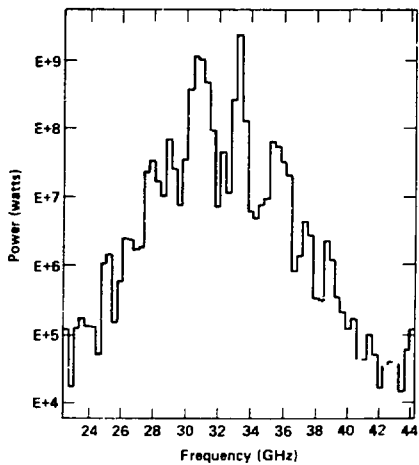
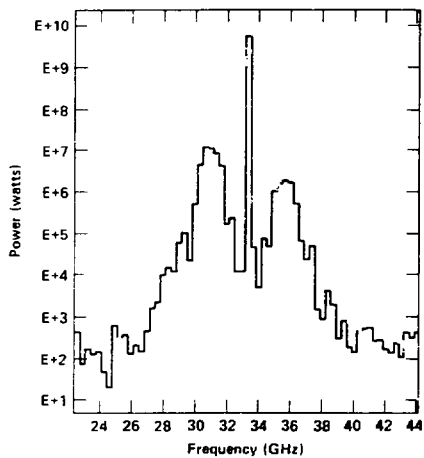
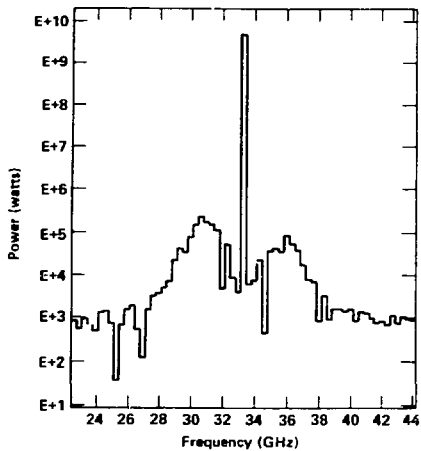
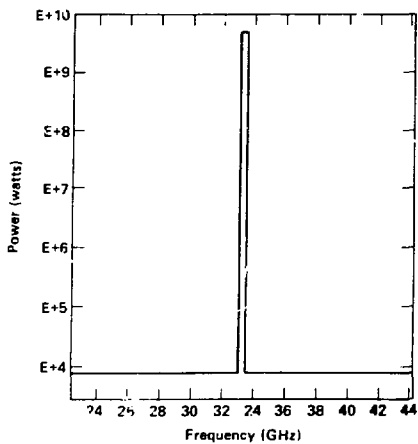

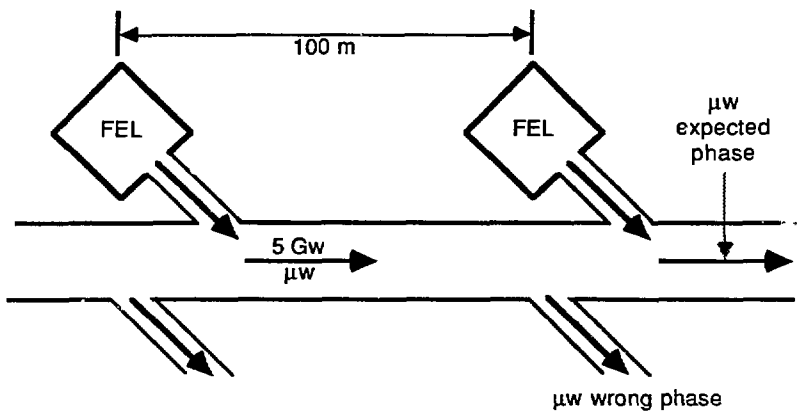

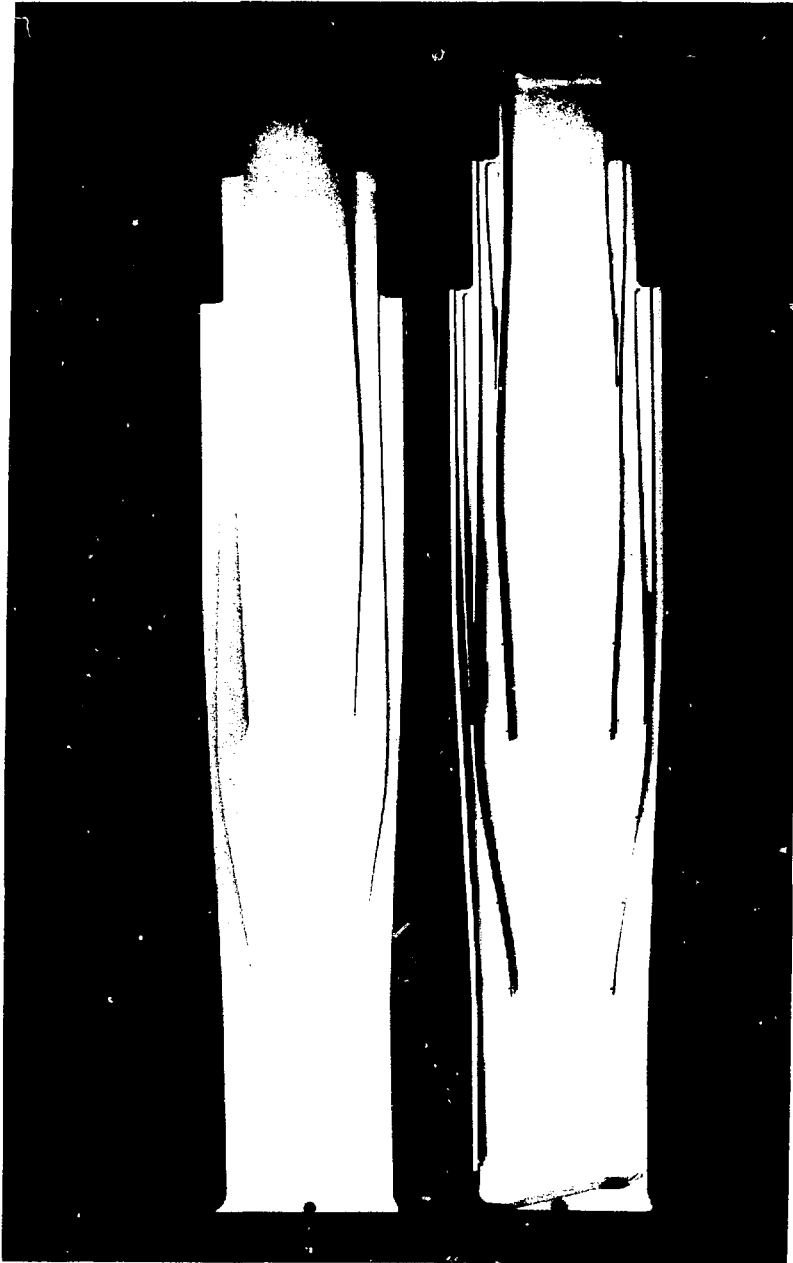

CBB 865-4063

Fig. 11

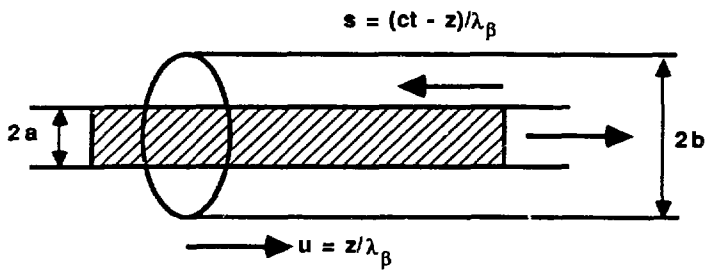

## The induction acceleration cell

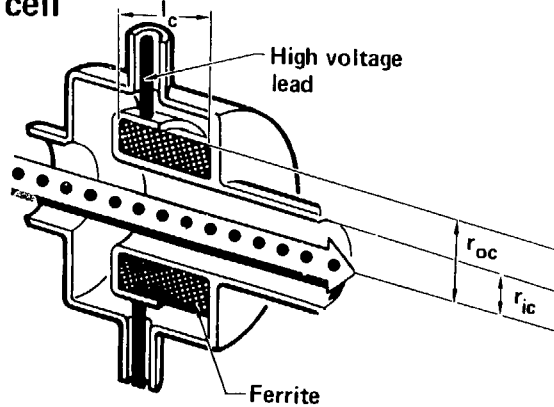

## The transfer cavity

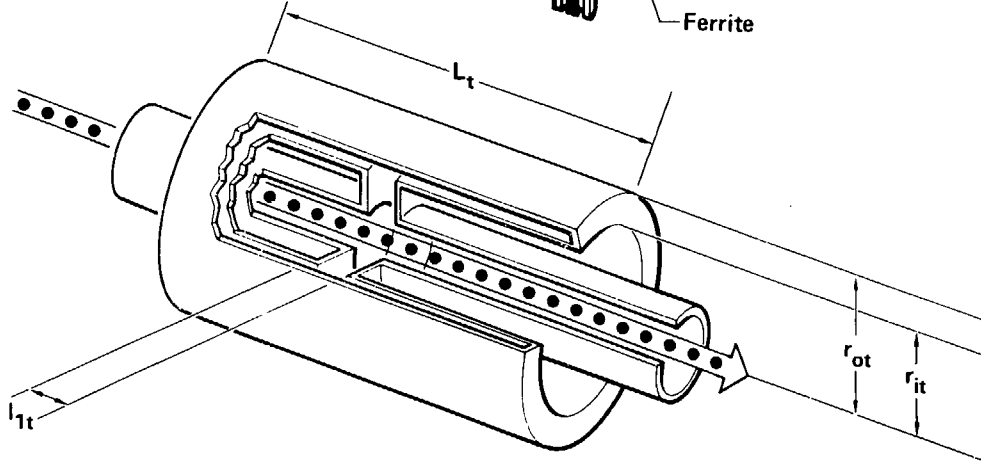

1. Upgrade of conventional klystron (~50% efficiency)

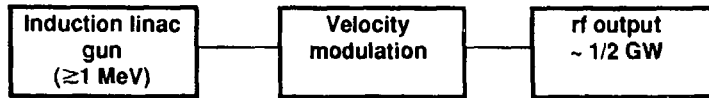

2. Efficient decelerator (~ 80% efficiency)



3. Two-beam-accelerator (~ 100% efficiency)

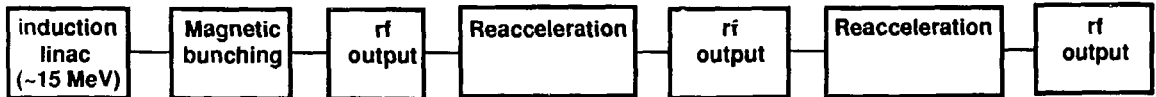

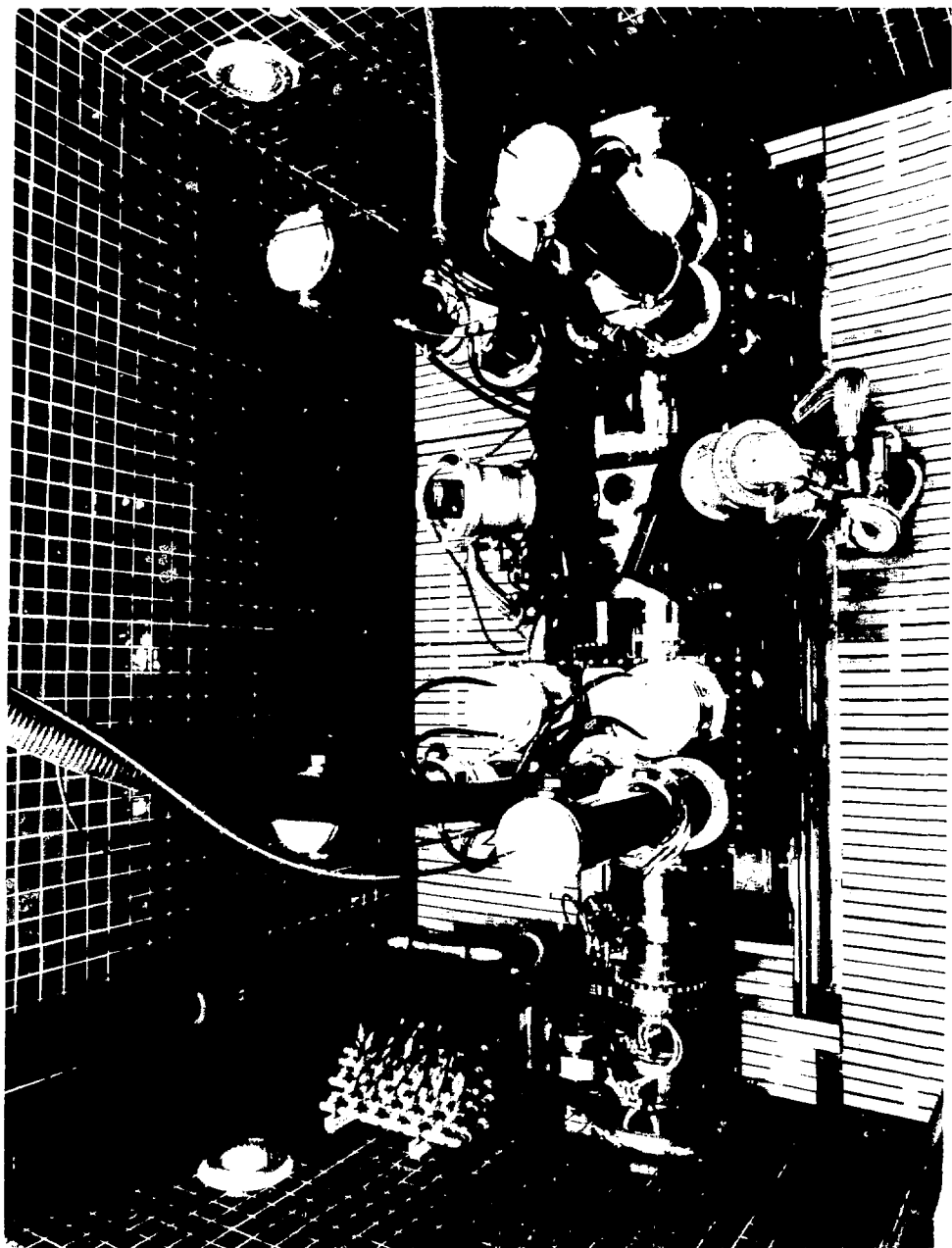
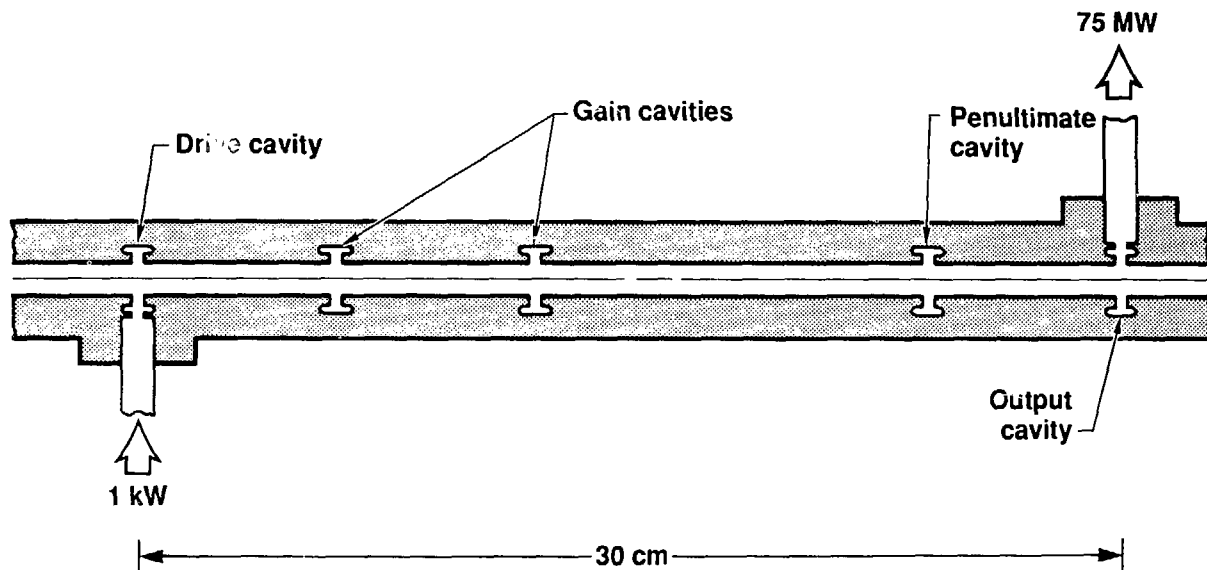

Fig. 15





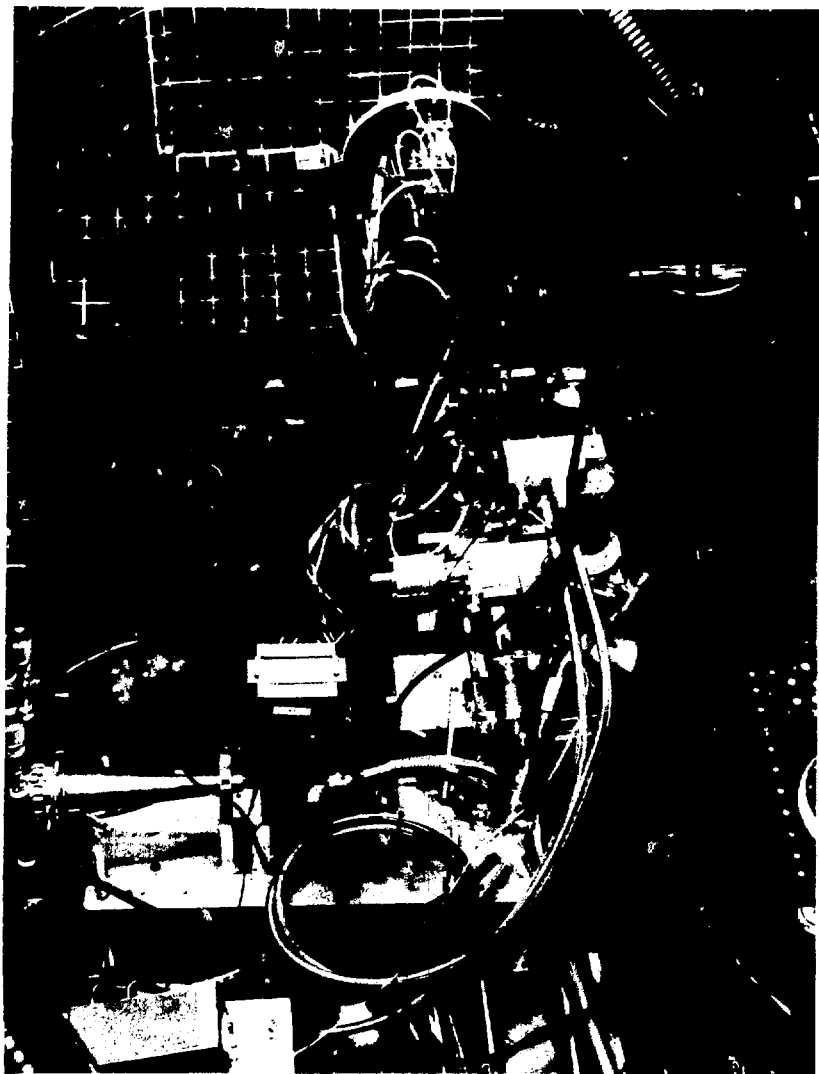
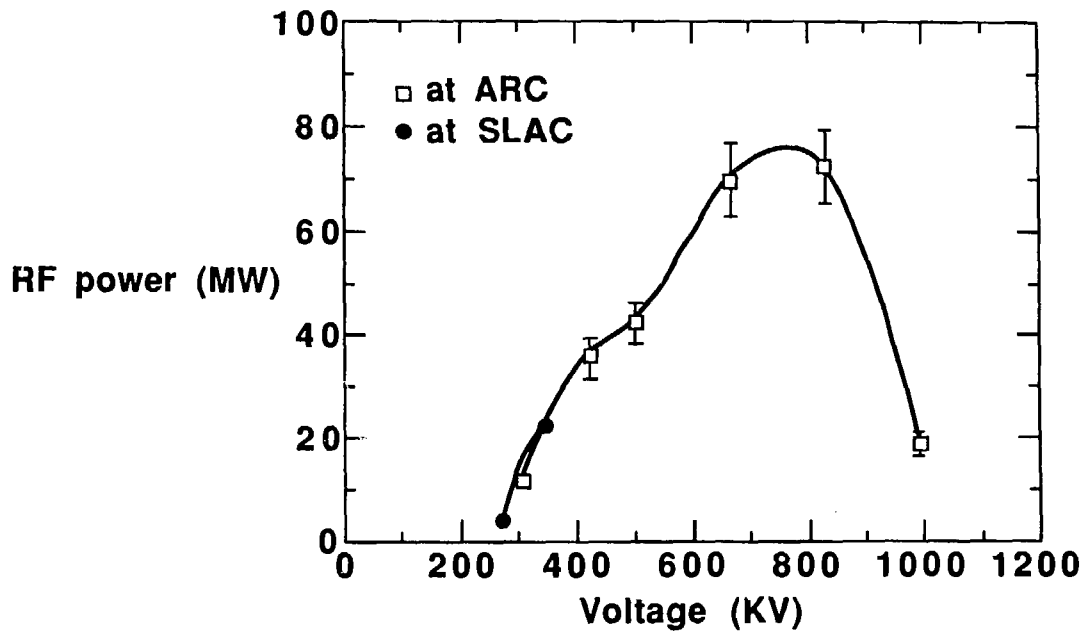
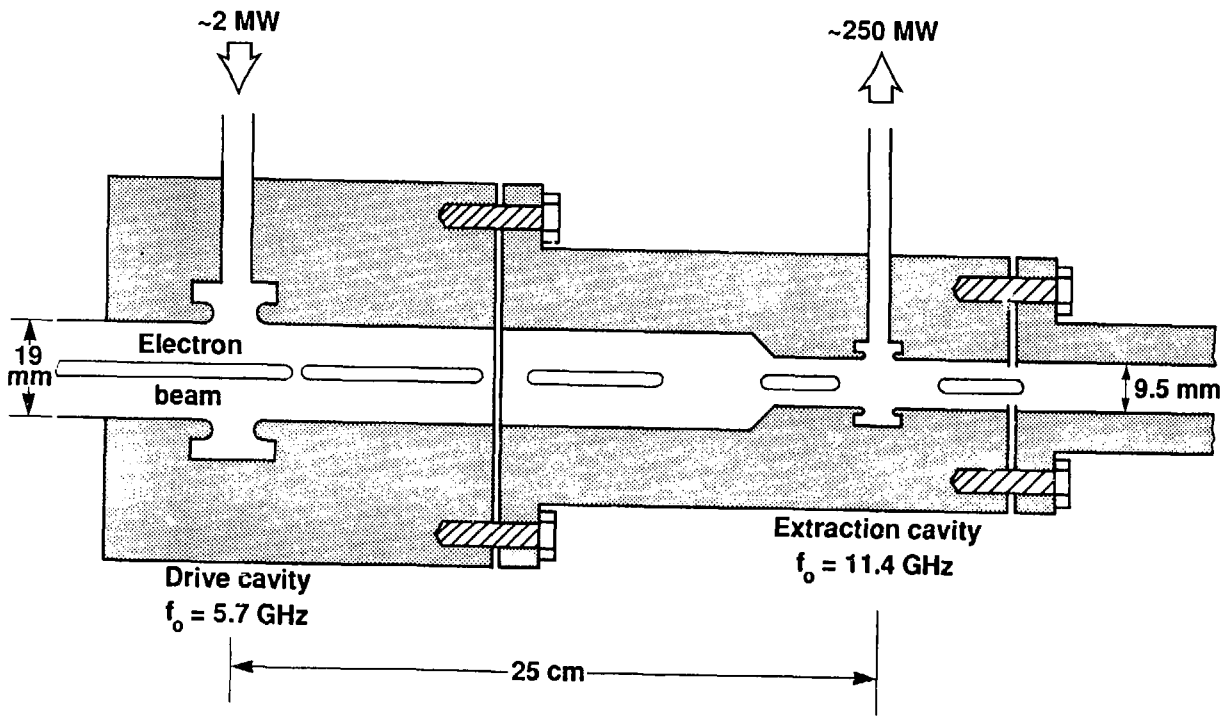
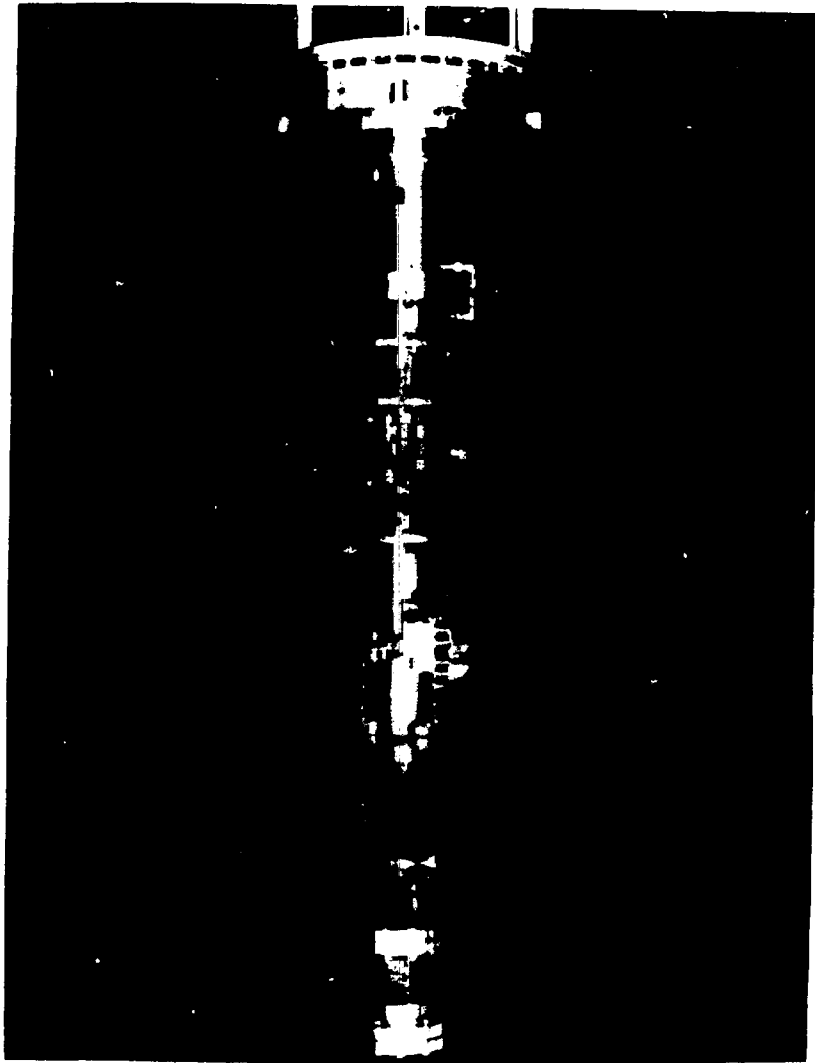

Fig. 17

CBB 888-8535







CBB 888-8537

Fig. 20

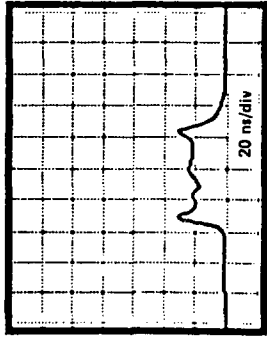

(a)

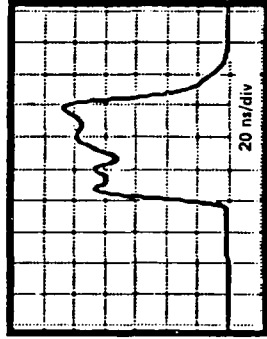

(b)

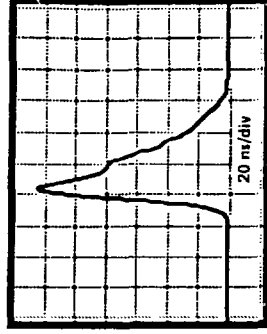

(c)

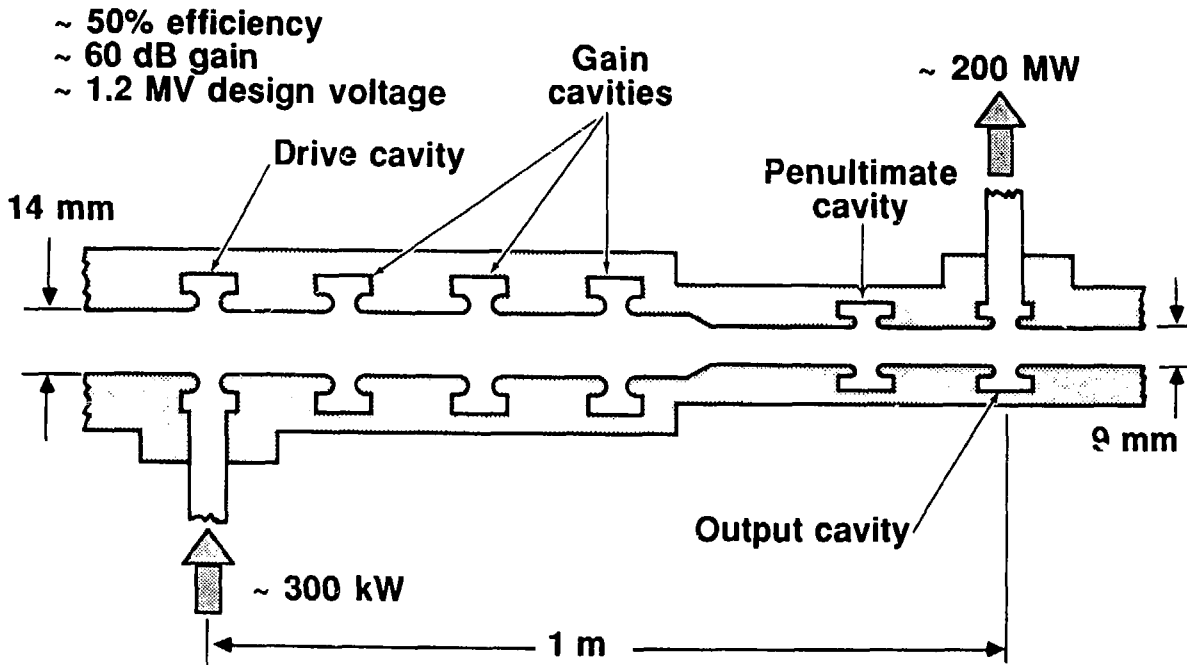

# Status of SL4, April 15, 1988

---

Output power at 11.4 GHz = 196 MW

Peak surface field = 280 MV/m

Beam energy = 975 kV

Current transmitted = 625 A

Efficiency = 32%

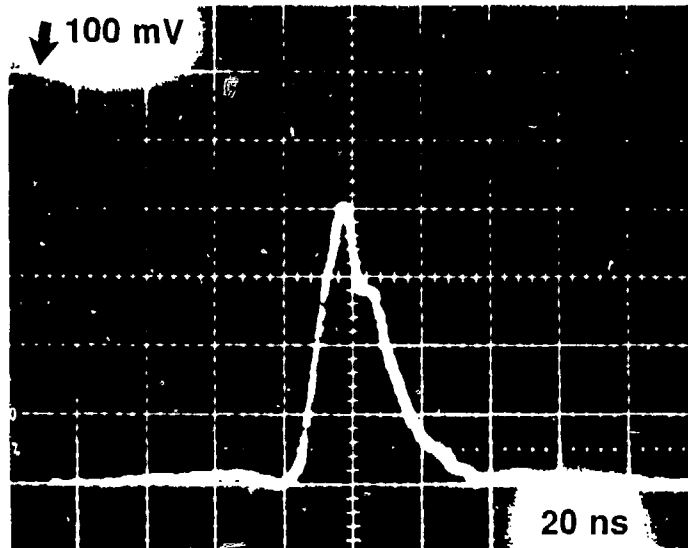

90-A-0488-0175E  
MM

FRNION

2

3

TEMP

32 40 48 56

6 12 18 24 30 36



FIG. 24





Fig. 25

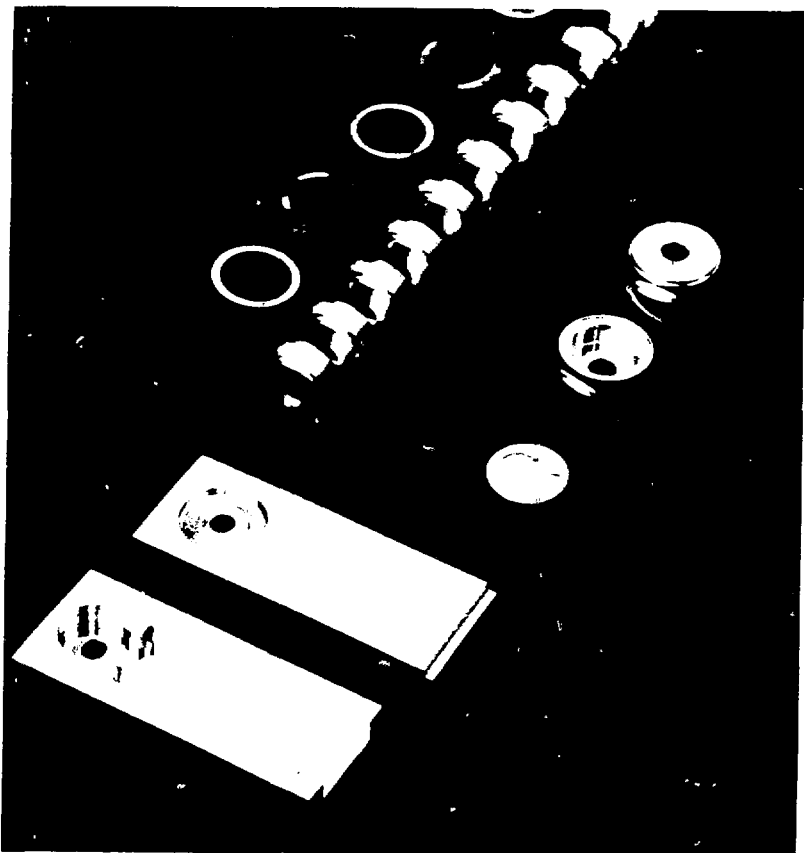

Fig. 26

CBB 888-8539