

IN SITU LEACHING OF URANIUM: TECHNICAL, ENVIRONMENTAL AND ECONOMIC ASPECTS

PROCEEDINGS OF A TECHNICAL COMMITTEE MEETING
ORGANIZED BY THE
INTERNATIONAL ATOMIC ENERGY AGENCY
AND HELD IN VIENNA, 3-6 NOVEMBER 1987



**A TECHNICAL DOCUMENT ISSUED BY THE
INTERNATIONAL ATOMIC ENERGY AGENCY, VIENNA, 1989**

**IN SITU LEACHING OF URANIUM:
TECHNICAL, ENVIRONMENTAL AND ECONOMIC ASPECTS
IAEA, VIENNA, 1989
IAEA-TECDOC-492
ISSN 1011-4289**

Printed by the IAEA in Austria
January 1989

**PLEASE BE AWARE THAT
ALL OF THE MISSING PAGES IN THIS DOCUMENT
WERE ORIGINALLY BLANK**

The IAEA does not normally maintain stocks of reports in this series.
However, microfiche copies of these reports can be obtained from

INIS Clearinghouse
International Atomic Energy Agency
Wagramerstrasse 5
P.O. Box 100
A-1400 Vienna, Austria

Orders should be accompanied by prepayment of Austrian Schillings 100,—
in the form of a cheque or in the form of IAEA microfiche service coupons
which may be ordered separately from the INIS Clearinghouse.

FOREWORD

Within the framework of its activities in nuclear raw materials the International Atomic Energy Agency has convened a series of meetings to discuss various aspects of uranium ore processing technology, recovery of uranium from non-conventional resources and development of projects for the production of uranium concentrates including economic aspects.

As part of this continuing effort to discuss and document important aspects of uranium production the IAEA convened a Technical Committee Meeting on Technical, Economic and Environmental Aspects of In-Situ Leaching. Although the use of this technique is limited by geological and economic constraints, it has a significant potential to produce uranium at competitive prices. This is especially important in the current uranium market which is mainly characterised by large inventories, excess production capability and low prices. This situation is not expected to last indefinitely but it is unlikely to change drastically in the next ten years or so.

This Technical Committee Meeting was held in Vienna from 3 to 6 November 1987 with the attendance of 24 participants from 12 countries. Eight papers were presented. Three technical sessions covered in-situ mining research, environmental and licensing aspects and restoration of leached orebodies. A fourth session was dedicated to the presentation and discussion of national reports from several Member States. Four Panels were held to discuss the technological status of in-situ leaching, the current status and future prospects of in-situ leaching of uranium in Member States, general aspects of planning and implementation of in-situ projects and the economics of in-situ leaching.

The Agency wishes to thank the participants and their Member States for their valuable contributions to the Meeting and the discussions. Thanks are especially due to the Chairmen of the technical sessions and panels, Messrs. W. Larson (United States), A. H. Montgomery (United States), C. Schmidt (Federal Republic of Germany) and D. C. Seidel (United States). The officers of the IAEA responsible for the organization of the meeting and for editing the proceedings were Mr. J.L. Rojas and Mr. S. Ajuria of the Division of Nuclear Fuel Cycle who also chaired Panel Discussion IV.

EDITORIAL NOTE

In preparing this material for the press, staff of the International Atomic Energy Agency have mounted and paginated the original manuscripts as submitted by the authors and given some attention to the presentation.

The views expressed in the papers, the statements made and the general style adopted are the responsibility of the named authors. The views do not necessarily reflect those of the governments of the Member States or organizations under whose auspices the manuscripts were produced.

The use in this book of particular designations of countries or territories does not imply any judgement by the publisher, the IAEA, as to the legal status of such countries or territories, of their authorities and institutions or of the delimitation of their boundaries.

The mention of specific companies or of their products or brand names does not imply any endorsement or recommendation on the part of the IAEA.

Authors are themselves responsible for obtaining the necessary permission to reproduce copyright material from other sources.

CONTENTS

Introduction to in situ leaching of uranium	7
<i>J.L. Rojas</i>	
A brief analysis of the supply and demand of uranium	21
<i>J.L. Rojas</i>	
Uranium in situ mining research by the United States Bureau of Mines — A review	37
<i>J.M. Pugliese, W.C. Larson</i>	
Restoration of in situ leached uranium ores: a laboratory study of restoration reagents	63
<i>D.C. Grant, H.A. Burgman, D.C. Seidel</i>	
Adapting uranium in situ mining technology for new commercial operations	75
<i>A.H. Montgomery</i>	
Groundwater restoration and stabilization at the Ruth-ISL test site in Wyoming, USA	97
<i>C. Schmidt</i>	
In situ leaching of Yozgat-Sorgun-Temrezli uranium deposit — Related laboratory experiments	127
<i>G. Öner, G. Nasün, A.I. Çataltaş, H. Okutan</i>	
In situ leaching of uranium in the USSR	143
<i>J.I. Skorovarov, R.H. Sadykov, V.D. Nosov</i>	
Potentialities of percolation leaching of uraniferous siltstone from Wadi-Nasib, Egypt	153
<i>M.A. Mahdy</i>	

PANEL DISCUSSIONS

Panel 1: Status and trends of the technology of in situ leaching	161
Panel 2: Summaries of national experience in in situ leaching	163
Panel 3: Development of in situ leaching projects	167
Panel 4: Economic considerations	169
List of Participants	171

INTRODUCTION TO IN SITU LEACHING OF URANIUM

J.L. ROJAS

Division of Nuclear Fuel Cycle,
International Atomic Energy Agency,
Vienna

Abstract

As an introduction to the several discussions on in-situ leaching, the main concepts of this technology are reviewed in order to clarify some important ideas such as: geological constraints, hydrology, aquifer restoration, environmental impacts and future trends.

In-Situ Leaching or solution mining are terms to describe a process for contacting a mineral deposit with leaching fluids to dissolve the mineral without having physically to remove the ore from where it is naturally placed. It is selective in that mostly only the mineral of interest is stabilised and flows to the surface for recovery.

It is technically classified as a mining method although it does not involve the classic concept of mining as an excavation of the ore. In-situ leach is a new technological development that began in 1974. During this time the techniques, methods and equipment for the process from basic concepts to successful commercial realisation had to be developed.

These are the aspects that could determine the characteristics of the In-Situ Leaching (ISL) process:

The most important aspect of ISL is that it has the potential to produce uranium at lower costs (less capital investment and lower operating costs per pound) than other mining methods if properly applied by an experienced operator to a suitable ore deposit. The second most important aspect is that this method is limited to only one type of uranium deposit; a roll front (deposited from moving groundwater) deposit in a permeable sandstone that must be an aquifer (sandstone filled with water).

The third most important aspect is that it is difficult to predict the performance of an ISL project. There have been a great many more unsuccessful than successful ISL projects. Since this process involves several competing chemical reactions taking place underground in a natural uranium deposit, the chemical and geological parameters affecting flow rates, reaction rates, and uranium production vary significantly from one ore deposit to another and indeed even within the same deposit.

Several companies have developed methods of testing and evaluating these deposits which include laboratory core leach studies, pump tests (hydrology studies) in the field, core analysis, logging techniques, and pilot leach projects. However, since it is not possible to quantify completely the parameters of a deposit which determine the effectiveness of the leaching process, the experience of the operator with ISL in a variety of geological settings and in relating laboratory and pilot performance to commercial performance is important in achieving a reliable low cost operation. In addition, in situ leaching of uranium is more sensitive to good engineering management and attention to detail than other types of uranium mining.

Prior to the operation of an in-situ leach mining facility it is necessary to collect data on: (1) geology, (2) hydrology, and (3) in-situ leaching mining impacts.

A portion of the principal items considered under each of these headings is given below.

A. Geology

Regional geologic structure and seismicity

Regional stratigraphy

Cross sections through the mining site depicting the location and trend of the ore zone and the confining beds

Isopach, contour, or structure maps of the mining site

B. Hydrology

Water levels (potentiometric levels) of the ore-zone aquifer and the aquifers above and below

Regional and local directions of ground-water flow

Total and effective porosity and permeability of the ore-zone aquifer

Water quality of the ore-zone aquifer including the ore body
and both upgradient and downgradient areas
Water quality of the aquifers above and below
Competence and extent of the confining beds

A. GEOLOGY OF POTENTIAL URANIUM LEACH MINING SITES

There is some degree of uranium mineralization in most tertiary and older sedimentary rocks of the western and southwestern United States. However, the principal regions of potential uranium recovery by in-situ leach mining are the Wyoming Basins, the Colorado Plateau, and the Gulf Coastal Plain of Texas. The southern Black Hills and northeastern Colorado, within the Great Plains region, also contain sedimentary uranium deposits that may be amenable to in-situ leach mining.

Leachable uranium deposits are found in sandstones that have been deposited in intermontane basins, along mountain fronts, and in near-shore marine and deltaic environments. Alternating periods of sluggish and swift streamflow, as well as changes in base level due to tectonic forces, have created a complex and heterogeneous sequence of sediments that may be greater than 6,600 ft (2,000m) thick. These sediments are fine- to coarse-grained arkosic sands, with some conglomerates, siltstones, and claystones. Successive scouring, filling, and beveling of channel segments have resulted in the lenticular and cross-bedded characteristics of the deposits. The stream-channel deposits become fine-grained away from the source of sediments where they commonly grade into carbonaceous shales and lignites, deposited contemporaneously in swampy areas or lakes.

Zones of uranium mineralization follow the general trend of drainage channels. However, individual ore bodies in sandstone lenses rarely exceed a few hundred yards in length; they are elongate and narrow, commonly a few tens of yards wide, and less than a few tens of feet thick. The geologic environment favoring the deposition of uranium ore is deficient in oxygen, has zones with less permeable siltstones and shales, and contains reducing agents such as carbonaceous material, hydrogen sulfide, or pyrite.

Source and Deposition of Uranium

The uranium in sandstone-type deposits is thought to have been derived from either granite, which supplied the material to form the arkosic sandstones, or from volcanic material that was deposited with, or later than, the sandstone, or perhaps from both. Granitic bodies containing uranium are found in many of the mountains that supplied the sediment comprising the host sandstones. Oxygenated ground water percolating through these units oxidizes and mobilizes the uranium.

As the uranium-enriched ground water moves through the aquifer from the basin edge toward the basin centre, it comes in contact with carbonaceous material and pyrite. During the period of active anaerobic decomposition of the organic material, the ground water and, therefore, will react to reduce the uranium to insoluble uraninite (UO_2). The dissolved oxygen is consumed, while hydrogen sulfide and sulfur from pyrite is oxidized to sulfate. Organic material and methane may be oxidized to carbon dioxide and water. The pH and Eh of the solutions decreases at this oxidation-reduced front. Further down gradient, the ground water is reduced, the pH is near neutral, and pyrite and organic material is found as the more stable phases for iron, sulfur, and carbon.

Freshly precipitated uranium along with uranium in the arkosic sandstone minerals is continually dissolved by oxygenated ground water and displaced further down gradient. Eventually, uranium of economically recoverable grade is deposited at the oxidation-reduction interface. The distribution of uranium and other elements in and around the ore deposits depends not only upon the oxidizing capacity of the ground water, but also upon the available reactive concentrations of precipitating agents.

B. GROUND-WATER HYDROLOGY OF URANIUM LEACH MINING SITES

The sedimentary sequence in which the uranium-ore bodies are found may be several thousands of feet thick and may comprise one interconnected hydrologic unit (aquifer). Characteristically, this aquifer is made up of a number of water-bearing units separated by confining units. The water-bearing unit containing the ore body has been defined as the ore-zone aquifer. The confining materials separate the ore-zone aquifer (at least locally) from other water-bearing units above and below. In all

cases, the aquifer zones are saturated with ground water moving in response to hydraulic forces.

The aquifer system is recharged by direct infiltration of rainfall or snow melt at the land surface. The recharge generally occurs in the outcrop areas and moves slowly downgradient to and through the ore body. The uppermost part of the aquifer system is under water-table conditions and the ore-zone aquifer is under confined conditions. Uranium deposits found in water-table aquifers cannot presently be mined by the in-situ leaching method.

The permeability of the typical ore-zone aquifer is generally less than 1,000 millidarcies (1×10^{-2} cm/sec). Individual wells completed in the ore-zone aquifer generally yield 5 to 10 gpm (0.3 to 0.6 l/s) which is adequate to meet domestic and livestock supply needs. Additionally, the ore-zone aquifer can produce enough water to support in-situ leach mining and even certain water-intensive restoration techniques without affecting the ground-water system's ability to meet other demands.

Depths below land surface to the ore-zone aquifer are between a few tens of feet and thousands of feet. Economic considerations determine which ore bodies will be mined; at present, only ore bodies less than about 500 ft (160m) deep are being mined.

POTENTIAL IMPACTS OF IN-SITU LEACH MINING

The water-quantity effects that can result from in-situ leach mining include excursions of lixivants during injection and natural migration of residual lixivants and other mine-affected ground water after mining has ceased. The ideal lixiviant for in-situ use is one that will oxidize the uranium, complex it so as to maintain it in solution, and interact little with barren host rock. Unfortunately, no lixiviant is entirely inert to the other minerals commonly associated with sedimentary uranium deposits. Numerous chemical interactions are possible between a lixiviant and the uranium and associated secondary minerals; therefore, lixiviant agents and concentrations must be adapted to each ore body to assure maximum uranium recovery while minimizing undesirable secondary reactions.

Lixiviants for in-situ leach mining are salt solutions of ions such as sulfate, bicarbonate, carbonate, and ammonium known to form stable aqueous complexes with hexavalent uranium. An oxidant such as air, hydrogen peroxide, sodium chlorate, sodium hypochlorite, or potassium permanganate, is added to the lixiviant to effect the oxidation of uranium. The lixiviant solution may have any pH, although the mineralogy of most uranium deposits dictates the use of neutral or basic lixiviants such as bicarbonate and carbonate lixiviants.

The principal geochemical reactions among lixiviants, ore minerals, and host rock are discussed below; secondary reactions, including those involving the geochemistry of some trace metals and minor elements, are given in Appendix C.

1. Principal Geochemical Reactions

Interactions and reactions between lixiviant agents and minerals, which occur at the time of lixiviant injection and may continue well after solution mining operations have terminated, can be divided into four broad categories: (1) oxidation and reduction, (2) dissolution, (3) reprecipitation, and (4) adsorption and ion exchange.

1.1 Oxidation and Reduction

Oxidation ultimately controls the amount of uranium recovered by solution-mining methods. The tetravalent ore minerals, uraninite and coffinite, are insoluble under reducing conditions but will dissolve in the presence of a suitable oxidant. The oxidizing agent may be injected along with the lixiviant or generated internally through the actions of the lixiviant on associated non-uranium minerals. For example, when hydrogen peroxide is injected in the presence of the bicarbonate ion, the oxidation reaction can be depicted by equation 1.1:

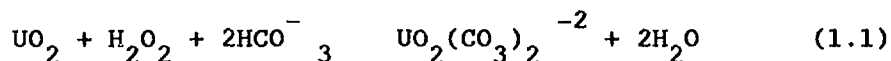

Any oxidant introduced with the lixiviant also may generate chemical species, such as ferric iron, which are capable of oxidizing tetravalent uranium. Oxidation of ferric iron may be the mechanism by which most of the uranium is actually oxidized. For example, chlorate ion

oxidizes ferrous iron to ferric iron, which, subsequently oxidizes uranium according to equations 1.2 and 1.3:

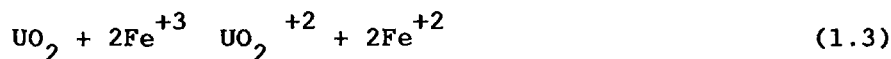
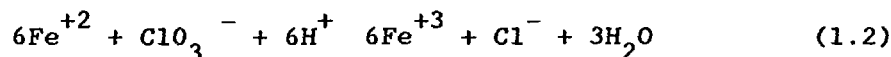

Once oxidized, the uranium is readily leached by sulfate, bicarbonate, or carbonate solutions.

1.2 Dissolution

During in-situ leach mining, other minerals are decomposed, with the extent of decomposition depending upon the chemical nature of the lixiviant and the minerals. In most instances, decomposition or dissolution of these minerals is undesirable, as it consumes lixiviants, introduces contaminants, and diminishes uranium recovery. Carbonate minerals are most susceptible to dissolution by the lixiviant solution; the extent depends on the pH of the lixiviant. For example:

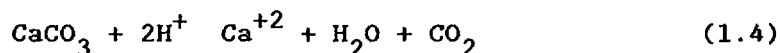

Mining with neutral or slightly basic lixiviants tends to minimize the dissolution of uranium-associated minerals. However, some alteration of carbonates and silicates is expected in localized zones. For example, ferrous iron minerals deposited in intimate contact with carbonates and silicates may undergo oxidation reactions that produce acid which, in turn, reacts with the same carbonates and silicates.

1.3 Reprecipitation

The mobility of many salt complexes placed into solution by the lixiviant is limited by reprecipitation and coprecipitation reactions. Reprecipitation of uranium may be detrimental to the in-situ leach mining operation by diminishing uranium recovery. Conversely, reprecipitation and co-precipitation of non-uranium elements may be beneficial by reducing the contaminants recovered along with uranium. For example, calcium ion can reprecipitate as gypsum or as secondary calcite. Hexavalent uranium may coprecipitate depending upon the concentration of dissolved uranium and upon the degree of lixiviant supersaturation with respect to calcite or

sypsum. Oxidized uranium may also become fixed within the structures of slightly soluble vanadate and arsenate minerals than can form during the leaching process.

Uranium is especially susceptible to precipitation whenever the oxidizing potential of the solution transporting the element has been diminished. This may occur when the lixiviant migrates toward the border areas of the leach field where it comes in contact with unleached, reduced rock. Chemical reduction and subsequent reprecipitation of uranium, and other trace elements, is possible under these circumstances and may, in essence, reverse the leaching process.

1.4 Adsorption and Ion Exchange

The principal mechanism for removing heavy metals from solution is the adsorption on colloidal precipitates of hydrous iron oxides. Ion exchange between lixiviant and clay material can also be anticipated. Montmorillonite clay, commonly present as matrix material, has a high capacity for ion exchange, which can occur either at the surface of individual clay platelets or within layers in the clay structure. Calcium and magnesium, for example, may be replaced with sodium from the lixiviant.

Montmorillonite also has a high cation exchange capacity for potassium and ammonium, whose ionic radii are similar. Ammonium fixation is confirmed in leach tests with ammonium bicarbonate lixiviants. Nearly twice as much ammonium has been found in clays invaded by ammonium lixiviant as existed prior to leaching operations.

2. Hydraulic Impacts of Well Injection

The spacing and arrangement of injection and production wells and differences in the rates of injection and production are the variables that can be manipulated to achieve optimum hydraulic and economic leaching field design. The hydraulic response of an aquifer to fluid injection or production can be estimated if the hydraulic properties of the aquifer are known. The arrangement of wells is similar to that in networks used for secondary-recovery operations in oil fields, and can be classified as :

- (1) direct line drive;
- (2) staggered line drive;

- (3) five spot, and
- (4) seven spot.

The pressure distribution around a single well, for the steady-state case in which rates of flow are kept constant, is proportional to the volume of material injected or produced and inversely proportional to the thickness and permeability of the ore-zone aquifer. Calculations based on these factors will show how far beyond the edge of a well field the pressure effects extend. Assuming the case of a direct-line-drive arrangement and assuming that the outer row of wells is used to inject lixiviant, the pressure effects are calculated to be of significance only within a few tens of feet of the well field. Even if the field consists of a large number of rows of wells, this condition is maintained if the net rates of injection and production remain equal for all wells, except for the outer row of production wells, which must be produced at 1.5 times the average flow rate for each well.

On the other hand, model studies show that even a slight excess of injection (or deficit of production) at one well, in a well field that is otherwise balanced, creates a pressure front that expands rapidly away from the well field. Fluid flow will respond to this imbalance so that the injected lixiviant will begin to flow out of the field. However, unless flow is along a pathway of anomalously high permeability, such as a fracture or a sand lens, the movement away from the field will be very slow.

METHODS OF AQUIFER RESTORATION

As used here, restoration means the reduction of the concentrations of dissolved minerals, within the leaching field and in adjacent affected portions of the aquifer, to an acceptable level, based on regulatory considerations. Several techniques are being used or have been proposed to achieve restoration. Thus far, however, efforts have been limited to pilot-scale projects. Experience and consideration of geochemical and geological principles indicate that restoration of all elements and parameters to baseline levels will be very difficult, if not impossible. However, restoration based on water use, appears to be possible.

The restoration technique being considered most widely today involves pumping residual fluids from the well field and drawing uncontaminated ground water from outside the field to displace the

residual fluids. Pilot-project tests indicate that the total dissolved solids concentration in ground water within the well field can be restored to the average baseline level. However, concentrations of trace metals, ammonia, arsenic, and selenium may not be returned to average baseline conditions.

To expedite restoration, simultaneous pumping of the well field and injecting of specially tailored fluid into the well field has been suggested. Natural ground water and treated leach-field water may be injected to displace and dilute residual lixiviant fluids. This technique may achieve reduction of total dissolved solids concentrations to acceptable levels, but the effect on any one constituent is unknown. The introduction of oxygen into the ground-water system by the injected water will allow continued mobilization of uranium and other oxidizable metals.

Another restoration technique utilizes the injection of special chemical solutions to remove certain bothersome constituents from the well-field ground water. Theoretically, the injection of reducing agents, such as hydrogen sulfide, will convert the soluble uranium and heavy metals to insoluble forms which will be naturally removed in-ground by precipitation. The solution left in-place will remain high in the major ions that are not affected by the reducing agents. This restoration approach has not been field tested. Ammonia desorption and removal has been field tested using salt solutions. Results indicate that some ammonia can be removed from the system but that baseline water-quality conditions are not restored.

Although it appears likely that natural geochemical processes can remove objectionable minor elements, the amount of time for natural restoration cannot be predicted based on current knowledge. Natural restoration may not be effective in the removal of ammonia to baseline levels.

Evaluation of Restoration Techniques

Techniques of leach field restoration that have been attempted or proposed are:

- (1) Pumping of selected leach field wells;

- (2) Pumping of selected leach field wells in combination with injection into other selected wells of natural ground water, recirculated treated leach field water, or one of the above types of water with chemicals added; and
- (3) Natural restoration.

In evaluating these techniques, it must be realized that, as previously mentioned, the only existing experience with leach field restoration is at the pilot project level. Some problems with extrapolating pilot-scale restoration results to production-scale operations therefore exist. First, the geologic and geochemical framework of the pilot-scale operations may be different. For example, a pilot-scale project might be entirely within and surrounded by an ore body, whereas the production-scale operation would be expected to extend to the limits of the ore body. Second, a pilot-scale operation, because of its small size (typically only a single five-spot array of wells), would not be expected to encounter the stratigraphic variations that will commonly be found over the area of a production-scale operation.

ECONOMIC ASPECTS

From a practical point of view the most interesting thing of an in-situ leaching project is the possibility of producing uranium at lower costs (investment and operating) than other conventional (underground) methods.

The factors which are important in achieving a low cost ISL project are:

- Concentration of uranium in the water produced from the wells. The concentration can vary from essentially zero to 900 mg/l on a continuous basis. The initial concentration from an individual well soon peaks in a few days at high values (typically 300 - 600 mg/l) and then declines rapidly. The decline slows down as the concentration reaches 30 - 50 mg/l. The well is usually shut in when the concentration reaches 10 - 20 mg/l after eight to eighteen months operation. It is important to maintain a high average concentration such as 40 - 70 mg/l if a low cost operation is to be achieved. However, some low cost operations have averaged 25 mg/l but at sustained high flow rates. A project must average the

desired uranium production rate which is determined by the product of uranium concentration and flow rate. The factors which determine the uranium concentration from the wells are:

- . grade of ore contacted;
 - . dilution of uranium concentration by water flowing through zones which do not contain economic grades of uranium;
 - . oxidant concentration;
 - . carbonate ion concentration;
 - . reaction rate of the uranium mineral;
 - . reaction rate of the competing oxidant reactions such as pyrite and organic carbon;
 - . permeability of the ore zone;
 - . location of the ore in the multiparameter portions of the sand.
- Completing the wells in the proper location and over the proper interval to achieve effective contact with the uranium deposit. It is necessary to define the ore zone with intense predevelopment drilling so that we can design the most effective flow distribution system for contacting each ore pod.
- The flow rate per well. Whilst a project must be designed and planned for a given total flow rate, and the uranium production rate is dependent on total flow and uranium concentration, it has to obtain flow rates for individual wells significantly, and obtain the maximum sustainable and controllable flow rate per well in order to minimize investment in wells and operating costs by limiting the number of wells operated at any one time.
- Sustaining reliable flow rates and uranium concentration by control of water chemistry. Unless the operator is very careful in managing water chemistry, several flow and uranium production problems can develop. Problems such as calcium carbonate precipitation, gypsum precipitation, bacteria growth, reduced ion exchange resin loading of uranium, and damage to the ion exchange resin can be controlled by proper water chemistry management.
- Continually adding new wellfields to maintain the desired production rate. Since the wells only last approximately one year, the project must be continually supplied with new wells.

- Minimizing equipment and operating costs by sizing the process operations optimally and eliminating unnecessary expense.
- Constant review of wellfield and plant performance to maintain production at a maximum.
- Ore reserves that are adequate in size and quality.

The company with major experience in in-situ leaching mining of uranium could be Everest Minerals Corp. which has introduced three innovations in the process.

One of the major technological advances which we have implemented is the satellite system which permits the installation of only ion exchange recovery facilities at wellfields. An ion exchange recovery facility is put in the wellfields where the ore is located and the resin loaded with uranium is taken to a central resin processing facility. This has the advantage of allowing many scattered smaller deposits to be mined economically, by minimizing the investment and operating labour required at each ore deposit. This method also allows high production to be maintained through the central resin processing facility, keeping down the operating costs per pound of uranium processed through the facility.

Another innovation which has helped costs is the development of a low cost method of gravel packing wells. This allows us to increase well flow and uranium production by 2 to 5 times that of conventional completed wells, for an increase of about 6 to 7% in cost. With gravel packed wells the surface filtration equipment can be dispensed with, reducing investment in the satellite facility, and allowing high volume down-flow ion exchange columns.

A third major Everest innovation is the use of irrigation for disposal of wellfield waste water streams, the wellfield purge water and wellfield restoration fluid. This method has the advantage of much lower investment and operating costs than a disposal well or evaporation in ponds.

FUTURE TRENDS

As for future trends, the primary development which will take place is the application of ISL to deeper projects. However, the cost of wells increases significantly as they become deeper, so that richer or larger uranium deposits are required at depths of 600 meters. It has been mined successfully on a commercial scale at 200 metres while average depths have been 150 metres. There has been a pilot plant at 600 metres which was apparently a technical but not an economic success. There are other problems with deep ISL mines such as well deviation control, well completion cost control, and water quality (some deeper uranium deposits are in salt water). Considerably more development will be required before such reserves can be considered as a reliable low-cost source of uranium.

With regard to the impact of ISL mining on the worldwide supply, it has been demonstrated that ISL mining properly applied to a suitable ore deposit can compete in costs even with the very large high grade Canadian and Australian mines. However, this method is limited to one type of uranium deposit. While there are a great many reserves that are roll-front deposits in permeable sandstones, there has not been a large accumulation in one place such as in the Saskatchewan deposits or Australia. I know of some ISL mineable deposits that contain 20 to 30 million lb U_3O_8 but I do not know of any locations where there are 100 million lb or more in one area.

ISL mining will be limited not by the market place but by the availability of suitable ore deposits. Production might increase from the current 2 million lb U_3O_8 per year to some 5 - 15 million lb a year worldwide. There are known reserves in countries outside the USA which could be mined by ISL methods; Australia, South Africa, Gabon, Zambia, and Brazil are all reported to have orebodies which are suitable for this method. These projects could provide lower cost uranium than some of the current projects contemplated in these countries. However, they are unlikely to be developed as long as the larger conventional projects take priority for development in those countries.

A BRIEF ANALYSIS OF THE SUPPLY AND DEMAND OF URANIUM

J.L. ROJAS

Division of Nuclear Fuel Cycle,
International Atomic Energy Agency,
Vienna

Abstract

Based on the most recent updates of nuclear capacity forecasts, the evolution of the installed nuclear power in the World is analysed, considering the WOCA and socialist countries till the year 2010.

From these forecasts, the uranium requirements in WOCA countries is studied. The forecasts of the most well known institutions have been included and two scenarios have been established.

The uranium resources of the last Red Book have been compared with the requirements and the future uranium production have been classified in these categories, depending on the degree of expectancy to be put in future operation.

Considering all these things the interaction between supply and demand have been established in the horizon of the year 2010.

1. Introduction

I want to show you in the following minutes, like a very brief introduction to this Meeting on the In-situ leaching of uranium, a general picture of the nuclear industry situation all over the world.

I have taken into consideration the most recent updates of the projected nuclear capacity, at first in WOCA and afterwards in the WORLD.

The uranium requirements in WOCA are analysed using these basis, following that the different available sources and a brief discussion is established in order to know which will be the most likely tendencies for the next years.

Speaking of this future I think there are two horizons. The first one is until the year 2000 and the second horizon is beyond this point. Several estimations have been made related to the long term projections: 2020 and 2025 principally. In this presentation I have chosen only the year 2010.

Speaking of energy and specially of nuclear energy (a nuclear power station is built in 10-12 years), the year 2000 is like tomorrow and the projections of nuclear capacity and uranium requirements more than projections are calculations. But to extrapolate the conditions, in that nuclear energy will be developed during the next decade till the year 2025 or beyond is very dangerous. Then I prefer to look at the year 2010 "only", because there the risk of error is less.

2. Projected nuclear capacity

To elaborate the analysis of projected nuclear capacity all over the World, two different considerations have been made. The WOCA values at first and the CMEA (Council for Mutual Economic Assistance) after.

WOCA

In the present analysis five projections of the nuclear capacity in WOCA have been employed: EIA-DOE; NUKEM, NUEXCO, The Uranium Institute and the Red Book of OECD in its 1986 and 1987 updated version.

The results are given in the Table 1.

There are 50 GWe of difference in between the lowest and highest cases, that is enough for a forecast for the year 2000. In my opinion the most likely projection for the year 2000 is over 350 GWe and 400-450 GWe for the year 2010, considering that no changes will be in the current tendency of nuclear power development.

CMEA

In a recent paper presented to the Conference on Nuclear Power Performance and Safety held in Vienna last October, Mr. G. Ertel of the Secretariat of the Council for Mutual Economic Assistance said that the

installed nuclear power at the end of 1986 was of 36890 MWe and that is planned to install 80 power units with an aggregate capacity of about 70 GWe.

Considering that all of these 70 GWe would be installed in the year 2000 (optimistic case), the installed nuclear capacity would be at that time about 120 GWe. I have assumed that the total nuclear capacity in all countries of Central Planned Economy in the year 2000 could be ranged in between 96 and 120 GWe.

For the year 2010 it is acceptable to assume that this growth will continue and then to have in between 130 and 175 GWe installed in the CMEA countries.

TABLE 1. PROJECTED NUCLEAR CAPACITY IN WOCA (GWe)

<u>Years</u>	<u>DOE (1)</u>	<u>NUKEM (2)</u>	<u>U I (3)</u>	<u>Red Book (4)</u>	<u>Brown Book(5)</u> (OECD)
1986	225	225	225	225	224
1990	279	286	290	298	274
1995	315	318	332	342	307
2000	351	353	372	401	340
2010	-	-	-	525	404(2005)

(1) Upper Reference Case, World Nuclear Fuel Cycle Requirements 1986.

(2) Nukem Market Report, Sept. 87.

(3) The Uranium Market 1986-2000, Dec. 1986.

(4) Red Book 1986 and Update 1987.

(5) Electricity Nuclear Power and Fuel Cycle in OECD Countries, 1987.

WORLD

The addition of both quantities, WOCA and CMEA, gives us the projection of nuclear capacity in the World.

In the year 2000 will be installed a capacity of about 450 GWe and in the year 2010 about 550 GWe.

The evolution of installed capacity in the three areas, WOCA, CMEA and WORLD appears in Fig. 1. In this figure, several projections have been included for comparison with each other. In any case, it is not probable that the high projections can have any chance, if the current tendencies of the public opinion (people, governments, businessmen, etc.) in many countries, follow in this direction. It is possible to note that the curve is a typical S shape, showing the known three stages:

- from earlier than 1970 there is the installment of a new technology
- since 1973 strong increase till the year 1986.
- the next years it seems to be a consolidation stage with a lower annual increment of the installed power.

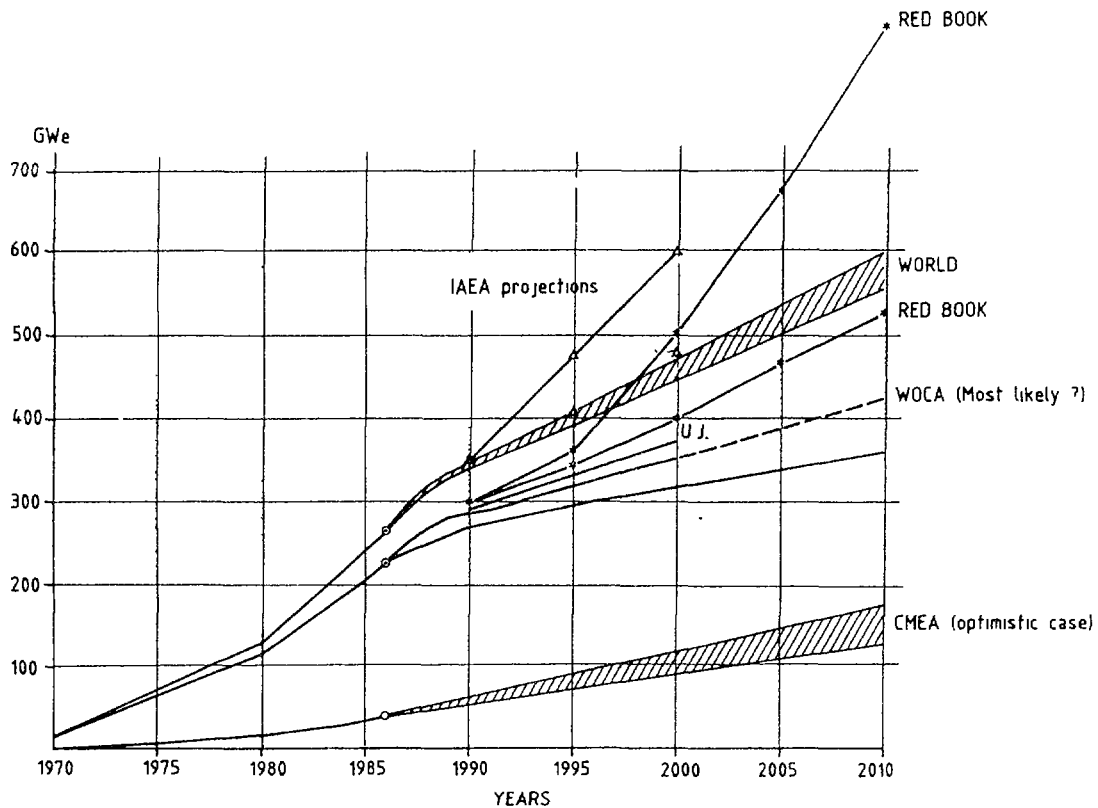

Fig 1 PROJECTED NUCLEAR CAPACITY IN THE WORLD

3. Uranium concentrates requirements in WOCA

This section presents projections of uranium concentrate requirements in WOCA based on several published projections in the current bibliography: DOE-EIA; Uranium Institute, NUEXCO, NUKEM and the Red Book of OECD.

The several values of these projections for the period 1985-2000 are shown in Table 2. For the year 2.000 the most likely values are around 52.000 tU, but with some discrepancy between the highest (62.000 tU) and the lowest (47.500 tU). For the year 1990 the most repeated values are in the level of 45-48.000 tU.

Beyond the 2.000 it is very difficult to establish a unique value. The most likely projections for the year 2010, range between 55.000 and 60.000 tU per year.

TABLE 2. WOCA ANNUAL URANIUM REQUIREMENTS

10 ³ tU					
Year	DOE(1)	U. I	NUEXCO(2)	NUKEM	Red Book
1985	34.3	-	-	-	37.0
1986		41.3	42.7	-	41.0
1987		42.3	42.7	41.9	41.0
1988	-	42.9	42.0	45.3	43.0
1989	-	43.0	44.7	42.6	45.0
1990	40.5	42.7	45.8	47.0	48.0
1991	-	43.4	43.9	45.0	46.0
1992	-	43.9	47.0	44.5	51.0
1993	-	44.4	46.6	46.2	52.0
1994	-	45.1	47.4	47.8	53.0
1995	43.1	45.1	48.1	46.5	55.0
1996	-	45.1	48.9	50.1	-
1997	-	45.7	48.5	-	-
1998	-	45.4	50.0	-	-
1999	-	46.7	50.0	-	-
2000	52.1	47.6	52.0	-	62.0

(1) Upper Ref. Case
(2) Low Case

In Fig. 2. all the historic and projected values of uranium requirements between 1960 and 2000 are given and it is possible to note very clearly that the shape of the curve is a typical S for the period considered. Then the short period of 10 years, starting from 2000 to the year 2010 is corresponding to the flat part of the S curve. The doubt is the high of this upper level of the curve, but this error could be of the order of ± 2.000 tU/y.

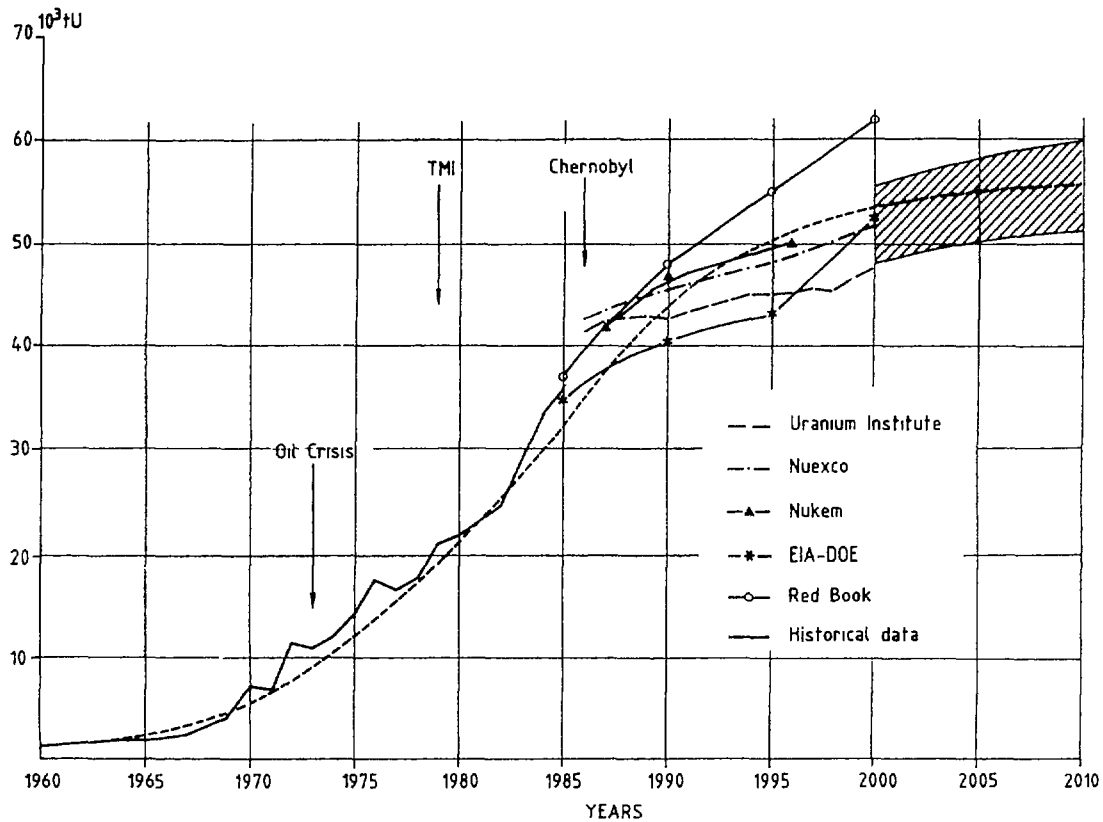

Fig.2 ANNUAL URANIUM REQUIREMENTS
WOCA

This form of the evolution curve is supported by the similar shape in S that has the projected nuclear capacity we have seen in Fig. 1.

In the Fig. 3. also is given the correlation S shaped curve whose equation is:

$$R_t = \frac{56}{1 + e^{4.01 - 0.176t}}$$

being R_t the Uranium requirement in the year/t

Then for the year 2010 the most likely projections of uranium requirements could be in the 51-60.000 tU/y, for a nuclear capacity of some 400-450 GWe.

4. Uranium Supply

It is necessary to discuss first the known uranium resources in order to know the possibilities of the supply in the future or potential offer.

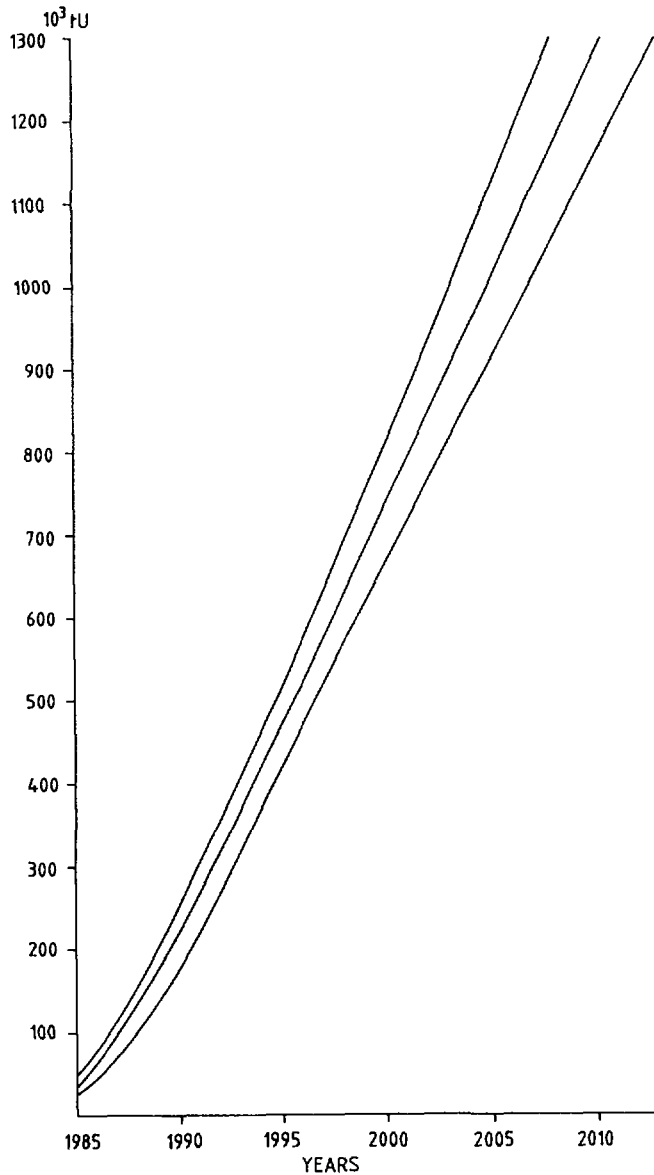

Fig 3 CUMULATIVE U REQUIREMENTS
WOCA

According to the Red Book of 1986, the different uranium resources are classified following the criteria of quality and cost in several categories nominated Reasonably Assured Resources (RAR), Estimated Additional Resources (EAR) and Speculative. There are three levels of costs: Under 80 \$/kgU, under 130 and under 260 \$/kg.U.

The classification and the quantities of uranium in each of them are shown in Table 3. Considering only the resources existing under 130 \$/kgU the total RAR are 2.25 million tons and including the EAR categorie I, the total quantity of resources is of 3.56 million tons U.

TABLE 3. URANIUM RESOURCES

	10^3 tU			
\$/Kg U	RAR	EAR I	EAR II	SPECULATIVE
260	417	444	634	540
130	666	415	529	$9.6-12.1 \times 10^3$
80	1,584	897	601	
Totals:				
130	2,250	1,312	1,130	
260	2,667	1,756	1,764	

Sources : Red Book 1986
 Up-date of Red Book 1986

The cumulative requirements of uranium concentrates beginning in the year 1985, for the year 2000 are oscillating between 650 and 800 thousand metric tons of uranium, depending on the related hypothesis. Fig.3. For the year 2010 the cumulative requirements from 1985 are in the range 1.2 -1.4 million tons.

Table 4. shows the comparison of Reasonably Assured Resources (RAR) and forward requirements (estimated in years and in thousands of metric tons U).

Despite the decline in resources that has taken place since 1979, the ratio of resources exploitable at less than \$ 130 per kg U to 20 years' requirements estimates now seem more secure: about 1.8 for 1985 and 2.01 for 1986 compared with a low of 1.0 in 1975 (the ratio peaked in 1981 at 2.02). The OECD.IAEA figures for 1985 also indicate at least a 20 year forward supply of resource at less than \$80 per kg U.

TABLE 4. REASONABLY ASSURED RESOURCES (RAR) AND FORWARD REQUIREMENTS (estimated in years and in thousands of metric tons of uranium except ratio)

	1975 ^o	1977	1979	1981	1983	1985	1986*
Resources US < \$80 kg U	1080	1650	1850	1747	1425	1669	1584
Resources US < \$130kgU	1810	2190	2590	2293	2000	2315	2250
10 yrs cumulative requirements	444	501	499	466	573	513	487
20 yrs cumulative requirements	1813	1619	1520	1133	1193	1221	1120
Ratio of resources < \$130kg to 20 yrs requirements	1.00	1.35	1.70	2.02	1.68	1.90	2.01

^o Slightly different cost categories to those listed

Sources (OECD Red Books : 1975, 1977, 1979, 1982, 1983, 1986.

* Up date 1986

4.1 Uranium Production

Although uranium resources represent the potential capability of supply, the reality of supply is the production and the production capacity for the future offer of uranium. In the following paragraphs we will refer to the uranium production in Western Countries (WOCA).

The historic evolution of uranium production since 1960 is given in Fig. 4 where it is possible to note the big movement experienced during the period 1975-1980, although there is a decrease since 1981 till the current time.

Many things have happened since the early 70's and many reasons could justify this evolution of uranium production, concerning prices of uranium, expenses in exploration, opening and closing of milling facilities, etc.etc. The result of these major upsets in the market was that uranium production after rising from 13000t U in 1968 to 42,000t U in 1980, fell back to 34,700t U in 1985.

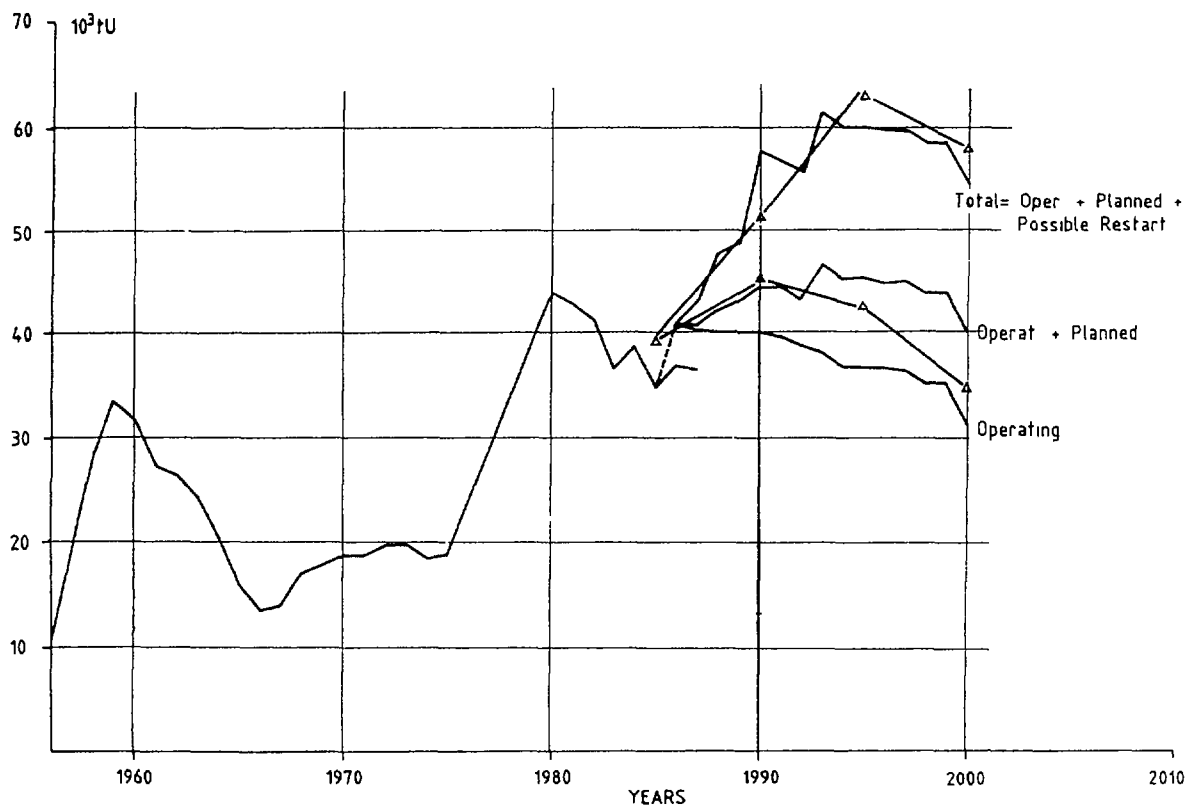

Fig 4 URANIUM PRODUCTION
(Historical and projected values)

In Table 5 the history of uranium production by country is given. It is possible to note the big increase of Canada's production and the sharp decrease of the USA's uranium production during the last decade.

TABLE 5. HISTORIC URANIUM PRODUCTION BY COUNTRY
(in thousands of metric tons of uranium)

Country	1976	1978	1980	1982	1983	1984	1985
Australia	0.4	0.5	1.6	4.4	3.2	4.4	3.3
Canada	4.8	6.8	7.2	8.1	7.1	11.2	10.9
France	1.9	2.2	2.6	2.9	1.0	3.2	3.2
Gabon	1.0	1.0	1.0	1.0	0.9	0.9	0.9
Namibia	0.7	2.7	4.0	3.8	3.7	3.7	3.5
Niger	1.5	2.1	4.1	4.2	3.4	3.3	3.2
South Africa	2.8	4.0	6.2	5.8	6.1	5.7	4.8
USA	9.8	14.2	16.8	10.3	8.1	5.7	4.2
Other	0.2	0.4	0.5	0.8	0.8	0.6	0.5
Total							
Western World	23.1	33.9	44.0	41.3	36.7	38.7	34.7

Sources: OECD/IAEA 'Red Book' December 1983 and August 1986, and Institute members' estimates

The South African production has also experienced a strong reduction in the last five years.

Future production capacity

Future actual production is difficult to forecast, but production capacity poses fewer problems. This report according to the Uranium Institute concentrates on production capacity grouped in four categories: Operating, Possible Restart, Planned, and Possible New.

The current operating production capacity which is expected to decline slowly as deposits are depleted. Due to the difficulties of operating at full rate it is usual in some cases to employ a production capacity based on 90% of rated capacity to allow for unplanned unavailability.

Table 6 shows also the evolution of the operating uranium production capacity forecasts, ranging from 41,000t U in 1986 until 31,000t U in 2000.

TABLE 6. HISTORIC URANIUM PRODUCTION AND URANIUM PRODUCTION CAPACITY FORECAST
(in thousands of metric tons of uranium)

<i>Historic uranium production</i>							
1970	1971	1972	1973	1974	1975	1976	1977
18.7	18.9	19.6	19.7	18.4	19.0	23.1	28.3
1978	1979	1980	1981	1982	1983	1984	1985
33.9	38.4	44.0	43.9	41.3	36.7	38.7	34.7
<i>Operating uranium production capacity forecast (at 90% rated capacity)</i>							
1986	1987	1988	1989	1990	1991	1992	1993
40.7	40.3	40.0	40.0	40.0	39.6	38.8	38.1
1994	1995	1996	1997	1998	1999	2000	
36.7	36.7	36.4	36.4	35.2	35.2	31.1	

Sources

Historic production OECD/IAEA 'Red Book' December 1983 and August 1986, 'Summary of Nuclear Power and Fuel Cycle Data in OECD Countries' ('Brown Book'), NEA, 1986, and Institute members' estimates

Operating capacity forecast Uranium Institute

These forecasts are somewhat lower than those given by Update 1986 of the Red Book which have been given in Table 7.

TABLE 7. URANIUM PRODUCTION CAPABILITY PROJECTIONS
Supported by RAR and EAR-I at \$130/kg of uranium or less

(Tonnes U)				
A) EXISTING AND COMMITTED CENTRES				
Country	1985	1990	1995	2000
Australia	4 500	5 400	5 400	5 400
Belgium	40	40	40	40
Canada	10 880	12 300	11 700	10 000
France	3 900	3 870	3 870	-
Germany	40	40-80	40-80	40-80
Japan	9	9	-	-
Portugal	119	170	170	170
Spain*	200	250	250	250
United States	4 350	7 700	6 100	4 300
OECD Total (rounded)	24 050	29 800	27 600	20 200
Estimate for Non-OECD WOCA	15 200	15 200	14 900	14 300
TOTAL	39 250	45 000	42 500	34 500
B) PLANNED AND PROSPECTIVE CENTRES				
Country	1985	1990	1995	2000
Australia	-	1 300	3 100	3 100
Canada	-	-	4 600	4 600
Germany	-	-	250	250
Greece	-	-	n.a.	n.a.
Italy	-	-	238	238
Portugal	-	100	200	200
Spain*	-	335	595	595
United States	-	3 200	7 100	4 700
OECD Total (rounded)	-	4 950	16 100	13 700
Estimate for Non-OECD WOCA**	-	1 700	4 400	9 900
TOTAL***	-	6 650	20 500	23 600
TOTAL A + B	39 250	51 650	63 000	58 100

* 1986 Red Book.

** For the countries that made estimates in the 1986 Red Book.

*** Some countries did not make estimates.

Possible Restart capacity represents the capacity that is shut down, but where maintenance of mine and mill is continuing and where there are estimated to be sufficient reserves to justify restarting should more favourable conditions return. However, the effect of elapsed time on the ability of a facility to restart has to be taken into account: the longer it remains on stand-by the less likely it is to restart. Because it could cost as much to restart a facility that had been shut down for several years as to build a new one, a declining restart capacity over time has been used. After five years on standby. Possible Restart capacity is recategorized as Possible New capacity. Table 8 summarizes these two categories: Possible Restart and Possible New, showing the number of projects by country, with an estimate of annual production capacity.

TABLE 8. MAXIMUM URANIUM PRODUCTION CAPACITY FOR POSSIBLE RESTART AND POSSIBLE NEW FACILITIES (at 90 % rated capacity)

Country	Possible New (metric tons U)	Possible Restart (metric tons U)	Number of projects
USA*	8000	5700	15/9
Argentina	700		1
Australia	7140		7
Brazil	850		1
Canada	3500		5
Portugal	350		1
South Africa	1100		various

*Possible New includes Possible Restart after 1992

Source Uranium Institute

Planned capacity is that which is expected to be brought into production by an already announced date. Such projects are already defined, and construction may have started; they represent either the expansion of operating facilities or new production capacity. All other known uranium projects, and the older Possible Restart operations, are considered under the heading of Possible New capacity. In the context of this report they are limited to cases where an annual mill production capacity has been estimated and published. Table 9. shows the estimated maximum annual production capacity for each of the four categories, and all these values have been represented in Fig.4 .

TABLE 9. MAXIMUM URANIUM PRODUCTION CAPACITY
(at 90 % rated capacity in thousands of metric
tons of uranium)

	1986	1987	1988	1989	1990	1991	1992	1993	1994	1995	1996	1997	1998	1999	2000
<i>Operating</i>	40.7	40.3	40.0	40.0	40.0	39.9	38.8	38.1	36.7	36.7	36.4	36.4	35.2	35.2	31.1
<i>Planned</i>	0.1	0.4	2.2	3.1	4.5	4.6	4.5	8.7	8.7	8.7	8.7	8.7	8.7	8.7	8.7
<i>Subtotal</i>	40.8	40.7	42.2	43.1	44.5	44.5	43.3	46.8	45.4	45.4	45.1	45.1	43.9	43.9	39.8
<i>Possible</i>															
<i>Restart</i>	0	2.6	5.7	5.7	4.7	3.6	0	0	0	0	0	0	0	0	0
<i>Subtotal</i>	40.8	43.3	47.9	48.8	49.2	48.1	43.3	46.8	45.4	45.4	45.1	45.1	43.9	43.9	39.8
<i>Possible New</i>	0	0	0	0	8.7	8.7	14.7	14.7	14.8	14.8	14.8	14.8	14.8	14.8	14.8
Total	40.8	43.3	47.9	48.8	57.9	56.8	58.0	61.5	60.2	60.2	59.9	59.9	58.7	58.7	54.6

Source: Uranium Institute

The historical values of uranium production since 1956 to 1985 and the values of the operating, planned and possible restart capacities projected by Uranium Institute and the Red Book are included in Fig.4.

5. Interaction between supply and demand

In the present analysis five estimations of uranium demand have been presented, covering all of them the period 1985-2000 and a projection of this uranium demand till the year 2010 has been made.

As a consequence of these estimations in Fig.5 appears as a shadowed zone the most likely evolution of future demand of uranium.

The three types of production capacity of the operating, planned and total (possible restart) are superimposed in the same Fig.5.

Comparing the operating and planned capacity with the most likely demand, appears a triangle of deficit from the year 1993 that will be necessary to cover with additional (possible restart) capacity. Into this range it is possible to place the unconventional methods of uranium production like recovery from phosphoric acid and in-situ leaching.

It is urgent to put in operation these production centers in order to have uranium ready on time and at low cost.

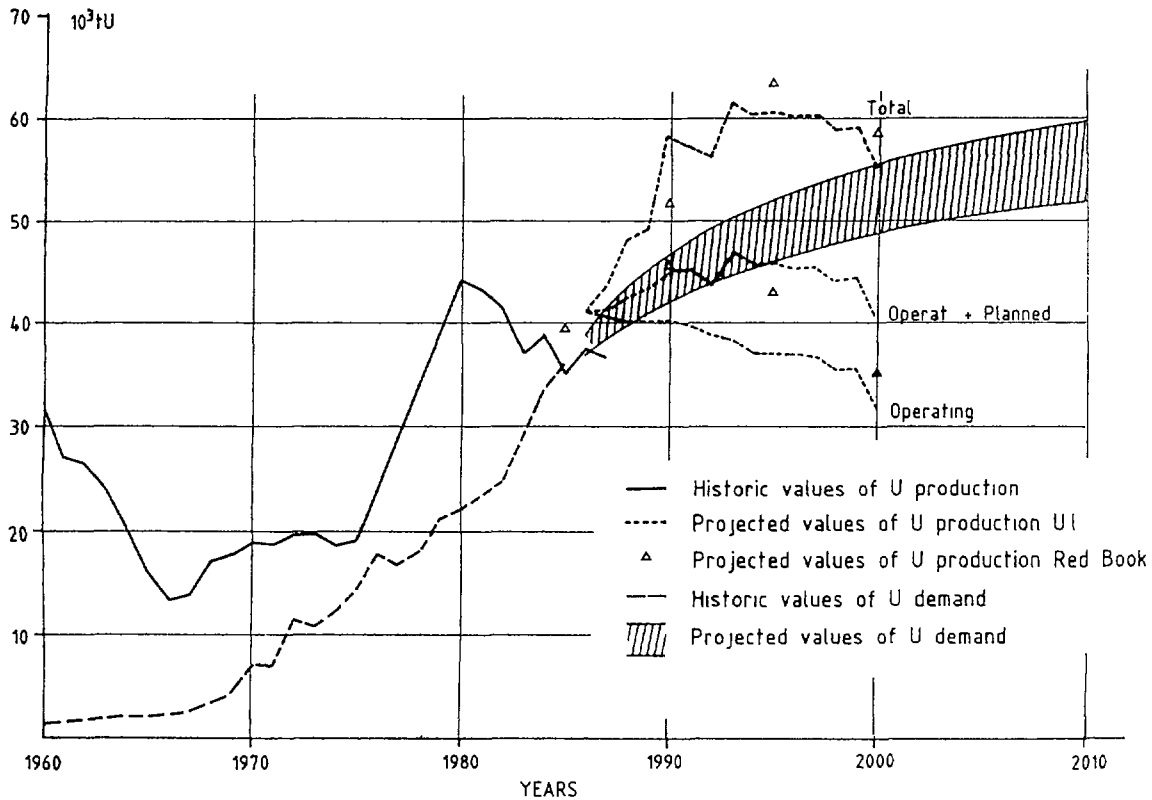

Fig 5 INTERACTION BETWEEN OFFER AND DEMAND

The total costs of these production centers must be maintained below 20-25 \$/lb U₃O₈, if a level of competitiveness is desired, because the selling prices of uranium will be into this range.

BIBLIOGRAPHY

- World Nuclear Fuel Requirements 1986, EIA-DOE 0436(86).
- Nukem Market Report, August 1987.
- Nuexco Monthly Report, March-Sept 1987.
- Nuclear Power: Status and Trends, IAEA, 1987 Edition.
- Nuclear Power Reactors in the World, IAEA, April 1987.
- Red Book 1986, OECD.

URANIUM IN SITU MINING RESEARCH BY THE UNITED STATES BUREAU OF MINES — A REVIEW

J.M. PUGLIESE, W.C. LARSON
Bureau of Mines,
United States Department of the Interior,
Minneapolis, Minnesota,
United States of America

Abstract

The Bureau of Mines initiated its in situ mining research program in 1974 to advance in situ mining as a viable alternative to conventional open pit and underground mining methods. At first, research work was conducted in two principal areas--fluid flow modeling, and geochemical modeling to represent leaching reactions in the ore body. Subsequently, the work effort evolved into a multiphase in situ mining research program designed to find a more economical way of mining while minimizing negative impacts on the environment. This paper discusses aspects of the Bureau's laboratory and field research accomplishments on the following topics: (1) permeability of uranium-bearing sandstone, (2) environment and restoration of ground water, (3) fluid flow and geochemical modeling, (4) environmentally attractive leach solutions, (5) well construction and completion, and (6) cost and sensitivity analysis for uranium in situ mining. Additional details about the research accomplishments are discussed in the Bureau publications and patents shown for each of these topics. Information is also provided on how to obtain copies of these Bureau references.

UNIT OF MEASURE ABBREVIATIONS USED IN THIS REPORT

cm	centimeter	lb	pound
d	day	pct	percent
ft	foot	ppm	part per million
gal	gallon	s	second
h	hour	yr	year
in	inch		

INTRODUCTION

In situ mining is a method by which leach solutions are injected into an ore body that has not been removed from its original geologic setting, and the ore minerals are mobilized and recovered in soluble form for processing. In situ mining has a number of important operating advantages over conventional open pit or underground methods. Typically, vertical injection wells are used to inject specific leach solutions into an ore deposit; once mobilized in soluble form, the leach solutions containing the metal values are recovered by production wells or underground collection systems. This technology virtually eliminates materials handling of ore and solid waste, including crushing, grinding, and hauling. Other advantages include minimum surface disturbance, less energy consumption, fewer workers on a production basis, and safer operating conditions.

Part of the Bureau of Mines' mission is to help assure an adequate and dependable supply of minerals at a reasonable cost. This mission is pursued in part through research to make mining and mineral processing safer, more productive, and more compatible with the environment.

The overall objective of the Bureau's in situ mining research is to accelerate the use of in situ mining technologies for deposits with marginal ore grades. This would increase the domestic reserves of lower grade deposits and create the potential for production of a variety of commodities not currently recoverable by conventional open pit and underground mining techniques.

During the past 15 yr, in situ mining has emerged as a viable third alternative to conventional underground and surface mining methods. For example, uranium has been produced from saturated deposits by in situ mining methods (1).

The Bureau has been conducting research on uranium in situ mining since 1974. A number of summary reports and state-of-the-art papers have been prepared that cover earlier aspects of the Bureau's uranium (and other commodities) research program (2-7). To provide an updated and consolidated review of uranium in situ mining research conducted and reported by the Bureau, Bureau in-house, contract, and other reports and patents were reviewed, and research results were gleaned from these documents. The research results covered under specific sections in this paper parallel those found in the indicated references. A section is included on how to obtain copies of many of the references.

U.S. BUREAU OF MINES URANIUM IN SITU MINING RESEARCH PROGRAM

The updated aspects of the Bureau's laboratory and field research are discussed in the following six sections: (1) permeability of uranium bearing sandstone, (2) environment and restoration of ground water, (3) fluid flow and geochemical modeling, (4) environmentally attractive leach solutions, (5) well construction and completion, and (6) cost and sensitivity analysis for uranium in situ mining. These six areas were chosen for study because research accomplishments in these areas would enhance the chances of in situ mining becoming a viable mining alternative.

PERMEABILITY OF URANIUM BEARING SANDSTONE

Uranium recovered by the in situ mining method occurs in the roll-type mineralized deposits (1, 8). The term "roll-type" denotes the general case where the uranium has precipitated along the oxidation-reduction front in several configurations (fig. 1). The deposits that have been considered for in situ uranium leaching have been associated with relatively shallow ore bodies (less than 1,000 ft) beneath the water table within confined aquifers. In general, the sandstone hosts for the uranium deposits are ancient channel sands that have been covered by more recent sediments.

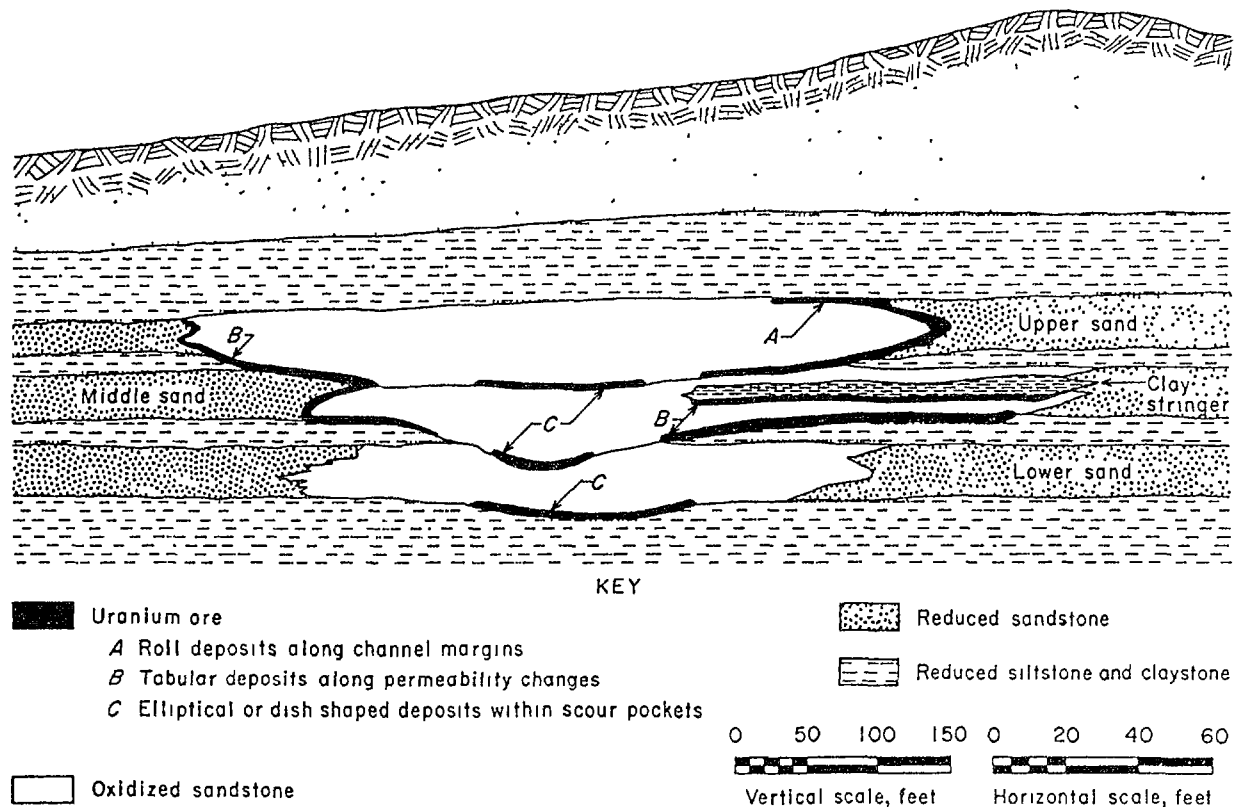

FIGURE 1. - A cross section showing configurations of the various types of uranium sandstone deposits (1, 8).

These sands are usually bounded above and below by relatively impermeable mudstones or shales, interspersed with clay stringers (fig. 2). The degree of consolidation of these deposits ranges from unconsolidated to very tightly cemented and consolidated sandstones. Because of this range in permeability and variability of the sandstone host, the Bureau reviewed the permeability test methods available.

The requirements for field permeability testing systems, to meet the needs for evaluating geologic formations for uranium (and copper) in situ leaching, were investigated (9) and further summarized (10). Field test methods for permeability measurements are discussed in these reports. Four test methods are considered suitable for field permeability tests above the water table for uranium and other commodities such as copper: (1) falling head test, (2) constant head test, (3) packer test with calibration, and (4) packer test with pressure transducer. In addition to

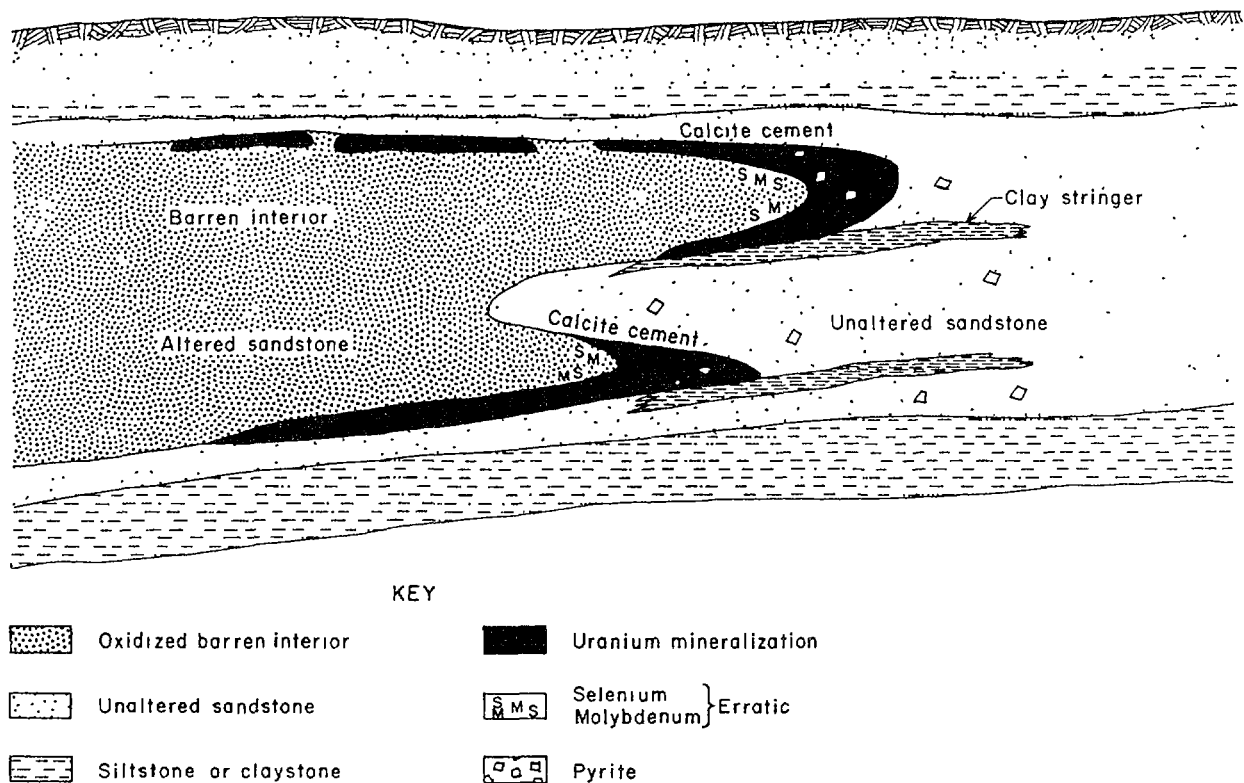

FIGURE 2. - A cross section showing the characteristics of an idealized uranium roll-front deposit (1, 8).

these test methods, the following are considered suitable for investigations conducted below the water table: (1) rising head test, (2) well pump test using equilibrium analysis, and (3) well pump test using nonequilibrium analysis.

According to O'Rourke (9), applied test methods and analyses need to be improved for the evaluation of fractured media, where the fractures, rather than the rock matrix, govern fluid flow through the rock mass. Practical difficulties remain also in estimating the three-dimensional-flow pattern through a rock mass laced with intersecting joint sets.

The Bureau (11) conducted laboratory and field experiments to determine the amount of permeability reduction in uranium sandstone after its exposure to different drilling fluids. Water was used for the permeability tests. Seven polymer and two bentonite fluids were tested in the laboratory in their clean condition, and six polymer fluids were tested with simulated drill cuttings (dirty) added to represent field use.

Sandstone cores cut from samples at an open pit uranium mine were the test medium. Results are given in the form of average return permeability (ARP), which is the ratio of the final to initial permeability, given as a percent. For the clean drilling fluid tests, the highest ARP's were achieved with the hydroxyethyl cellulose (HEC) (47 pct) and xanthum gum (44 pct). The results for the xanthum gum were quite variable and had a standard deviation of 24 pct. The lowest ARP's were obtained from the synthetic polymer (5 pct), the bentonite polymer combination (6 and 9 pct), and the two guar gum fluids (17 and 23 pct). For the dirty drilling fluid tests, the highest ARP was obtained from the multipolymer blend (43 pct). The lowest ARP results were from guar gum 3 (6 pct), xanthum gum (7 pct), and the synthetic polymer (7 pct).

A field test was run to compare how guar gum and multipolymer blend drilling fluids affect formation permeability when used for drilling in situ uranium leaching wells (11). The guar gum was chosen because it is commonly used in such leaching wells and gave poorer results in the laboratory. The multipolymer blend was chosen because it gave good laboratory results in the clean condition and the best results in the dirty condition. When fluid injection rates for the four wells drilled with guar gum were compared with those for the four drilled with the multipolymer blend, no significant difference could be determined from the injection rates. A conclusion was that undesirable foreign matter can be introduced in field conditions; the effect of this foreign matter overshadows the amount of damage done by polymer drilling systems (11).

The growth of microbial population during uranium in situ leaching is believed to be one of the causes of flow path plugging in the ore body (12-13). Leach solution and solid samples from well casings and submersible pumps were collected from an in situ mining operation that was experiencing plugging problems. A mixed culture of organisms from these samples was isolated and injected into a uranium core specimen to assess

the role of microbes in the plugging problem. Permeability was decreased. Hydrogen peroxide killed the microorganisms in the core and alleviated the plugging problem. Periodic injection of hydrogen peroxide into the ore body through production wells may reduce microbial plugging problems.

Maintaining adequate leach solution flow into the ore formation is often a difficulty for in situ mining operations (14). Swelling and dispersion of clay particles in the formation are often responsible for this permeability loss. Permeability and leaching tests were done in the laboratory on clayey ores to evaluate a clay-stabilizing polymer's effectiveness in preventing these problems. An alkaline sodium carbonate-bicarbonate leach solution of pH 8.5 and a sulfuric acid leach solution of pH 2 were used to leach the uranium ore samples. Test results at the end of 12 h indicated that treating the ores with the stabilizer could maintain permeabilities five times higher than that of the untreated ores when the alkaline leach solution was used. Although permeability loss in the uranium ore sample was less for the sulfuric acid leach solution than for the basic leach solution, permeability of treated ore was still twice that of untreated ore at the end of the 12-h and 14-d sulfuric acid leaching tests. Since in situ leaching throughput rate is directly related to permeability, these results indicate a potentially beneficial effect on operating parameters such as capacity and injection pressure. To determine the reasons for the success of the clay stabilizers, an investigation was conducted to determine the effect of the stabilizer on clay swelling and dispersion (14). Clay swelling tests indicated that the clay stabilizer reduced clay swelling. Zeta potential measurements made on fine clay particles treated with the stabilizer were compared to measurements made on untreated particles. The measurements indicated the stabilizer was electropositive and, therefore, could reduce the degree of negative charge on the particles and their tendency to disperse or migrate.

A reproducible laboratory method was developed for simulation of the leach chemistry and, to a limited degree, the hydrology of the in situ leaching of uranium (15). The method was used to determine the effects of leaching variables upon permeability and uranium extraction from ores similar to those being leached in situ in Texas and Wyoming. The use of such a method aids in the understanding of in situ leaching and the associated environmental restoration of the postleach ore body. Grant (15) describes the in situ simulation system and testing procedure in sufficient detail to allow one to construct the system and to perform leaching simulation tests. Additional information on the development of this system and on the numerous leaching and restoration tests performed using the system can be obtained from the reports (16-18).

ENVIRONMENT AND RESTORATION OF GROUND WATER

The Bureau assisted the Rocky Mountain Energy Co. in a pilot scale in situ leaching experiment at Casper, WY (19-21). The experiment lasted more than 2 yr. The purpose was to determine if sulfuric acid can be used as a cost effective alternative leach solution for uranium in situ leaching. At most in situ uranium leaching sites, ammonium carbonate-bicarbonate or sodium carbonate-bicarbonate is used as a leaching solution (19). Ammonium carbonate is an effective, highly selective leach solution for uranium, but flushing residual ammonium ions from the formation after leaching is difficult. The use of sodium carbonate avoids this problem but introduces the difficulty of reduced permeability because of clay swelling in those clays susceptible to swelling. Sulfuric acid was chosen because it avoids these problems, yet is an effective leaching solution.

Nigbor (19) describes activities at the experimental site, presents extensive geochemical data from startup to site restoration, compares laboratory and field experimental results, and discusses the environmental aspects of acid leaching. The data showed that sulfuric acid is apparently an effective leaching solution. Three to five grams of acid

per liter in ground water resulted in a production solution grade of 80 to 100 ppm uranium. Restoration was successful but required extended flushing. The pH was the last chemical parameter to return to baseline, requiring about 350 days. This was longer than was predicted in laboratory simulations. The data also showed that mobilization of toxic elements stayed within reasonable limits and then fell back to preleach concentrations during restoration.

According to Buma (22), ground water restoration is an important aspect of in situ uranium leaching. Information on the effectiveness of the current technology, costs, and the current State and Federal Government permitting regulations is of vital importance to in situ mining operations and entrepreneurs. This study describes (1) recent restoration attempts at commercial in situ leach operations, (2) restoration costs reported by the industry, (3) empirical equations that predict the minimum amount of ground water flushing required to meet the current restoration criteria, and (4) in situ uranium permit requirements for Texas, Wyoming, New Mexico, Utah, Montana, Colorado, South Dakota, and the Federal Government. The empirical expressions that were developed show that the amount of flushing required is a function of the type and strength of leach solution, and the ion exchange capacity of the formation (22).

For in situ mining, a major area of concern is the impact of the mining process on the quality of ground water supplies (23). As a result, a rapid and reliable technique for detecting leach solution excursions is desirable. Such a method would replace the periodic sampling technique and should provide a somewhat continuous monitoring method. In addition, such a technique, if it measures the properties of a volume of rock between wells, would be useful in giving greater areal coverage of monitoring effects.

Electric and electromagnetic techniques were evaluated in Wyoming through a contract (23) and in Texas through unpublished research by Bureau

personnel. Four-terminal galvanic resistivity measurements made on the surface were not sufficiently sensitive to indicate leachate movement. The controlled source audio-magneto-tellurics method (AMT) was unsuccessful because it was adversely affected by cultural magnetic noise. A method for measuring well-to-well resistance appeared promising in the unscreened wells in Wyoming (24). However, it was not successful in cased and perforated wells in Texas.

Bureau researchers are investigating whether tomographic reconstruction of seismic or electromagnetic crosshole data can show the location of leach solution. A computer program for tomographic reconstruction has been written and will be published shortly.

FLUID FLOW AND GEOCHEMICAL MODELING

A Bureau report by Schmidt (25) describes a hydrology model (ISL-50) that simulates flow at in situ mines. The model is intended to provide uranium resource developers with a description of the flow behavior of leach solution and ground water during the development, production, and restoration phases of a leaching operation involving an arbitrary pattern of injection and recovery wells. Site-specific validation procedures were developed for comparison of measured and predicted flow parameters, such as front breakthrough time and observation well drawdown. Six cases of ISL-50 applications are presented to describe program output and to illustrate the site-specific nature of each simulation (25). The six cases are (1) three stages of site operation, (2) screen versus wellhead locations, (3) directional anisotropy, (4) flow velocity contours, (5) three-dimensional simulation, and (6) five-spot confinement. Most of the reported graphics for these six cases were generated using actual field data.

Mineral recovery from an in situ leaching operation is determined by the often complex interaction of hydrology, mass transport, and chemical kinetics (26). The operating conditions of many uranium leaching

operations involve heterogeneities in aquifer permeability. Price (27) describes the inhomogeneities in permeability and mineralization that exist at the Hobson site (Everest Minerals Corporation) in Karnes County, Texas. Data from this site will be used in the following discussion on hydrology and geochemical modeling.

A different in situ leaching hydrology model (ISL) and a mass transport-oxidation rate model (ISLGC) have been developed for use in making site-specific predictions of the leachability and productive potential of heterogeneous ore deposits and for the optimal design of leachant injection operations (26). The two models are linked by output and input requirements. The effect of contrasting zones of permeability on leachant flow at the Hobson site can be simulated in two dimensions with the ISL. The cross-sectional streamline pattern between a single pair of injection and recovery screens (fig. 3) is generated using parameter values that closely approximate field conditions at the Hobson leach site. The permeability ratio between the barren and mineralized zones is $k_1/k_0 = 10$.

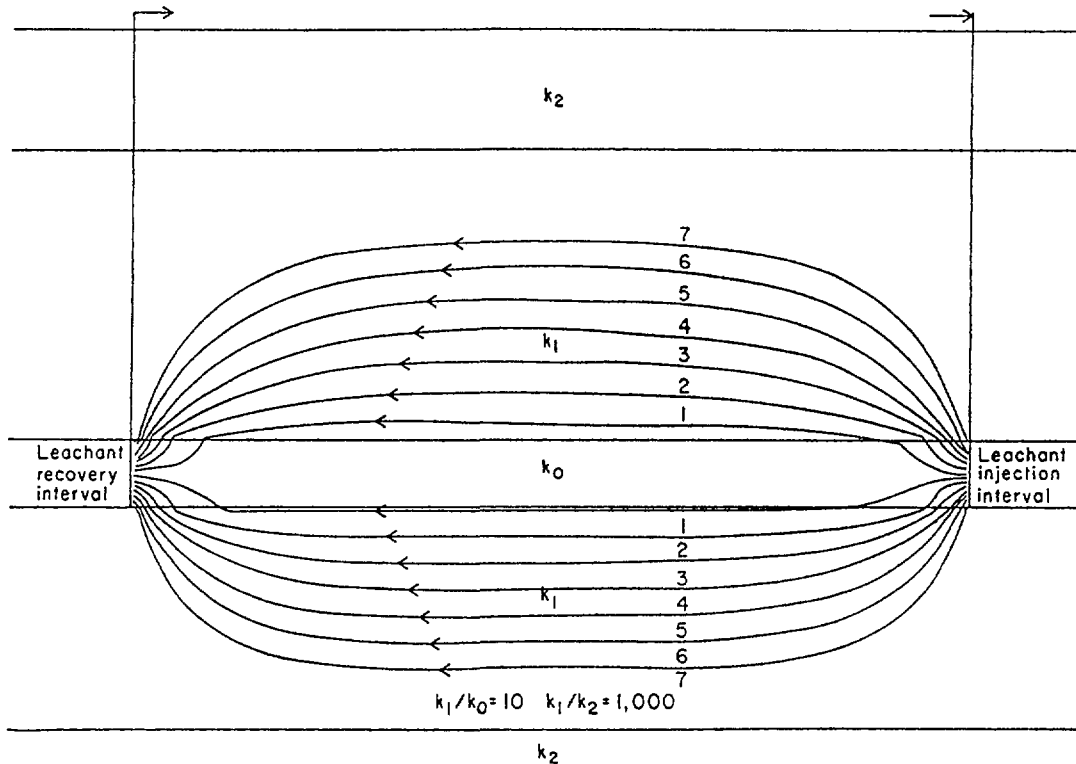

FIGURE 3. - Streamline pattern in a heterogeneous cross section (26).

If the hydrology data for the streamline pattern of figure 3 are input to the ISLGC, a simulation of the Hobson site is obtained that closely resembles the low recovery of uranium observed in the field (fig. 4). The low recovery is due to inadequate contact between leach solution and the uranium mineralization. When the streamline pattern of figure 5 is used as input to the ISLGC, the predicted field recovery curve closely approximates the theoretical uranium recovery curve derived from laboratory leaching experiments by T. R. Guilinger and as presented by Price (27) for the Hobson ore (fig. 6).

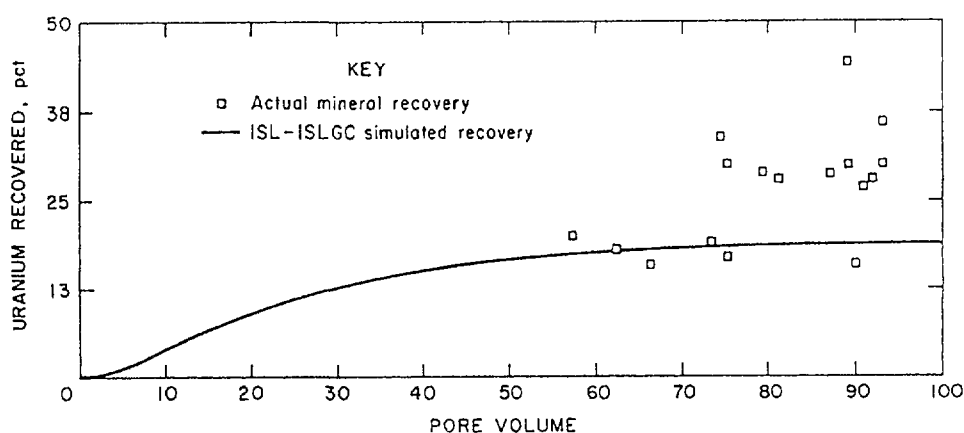

FIGURE 4. - Fractional uranium recovery from the Hobson site (26, 27).

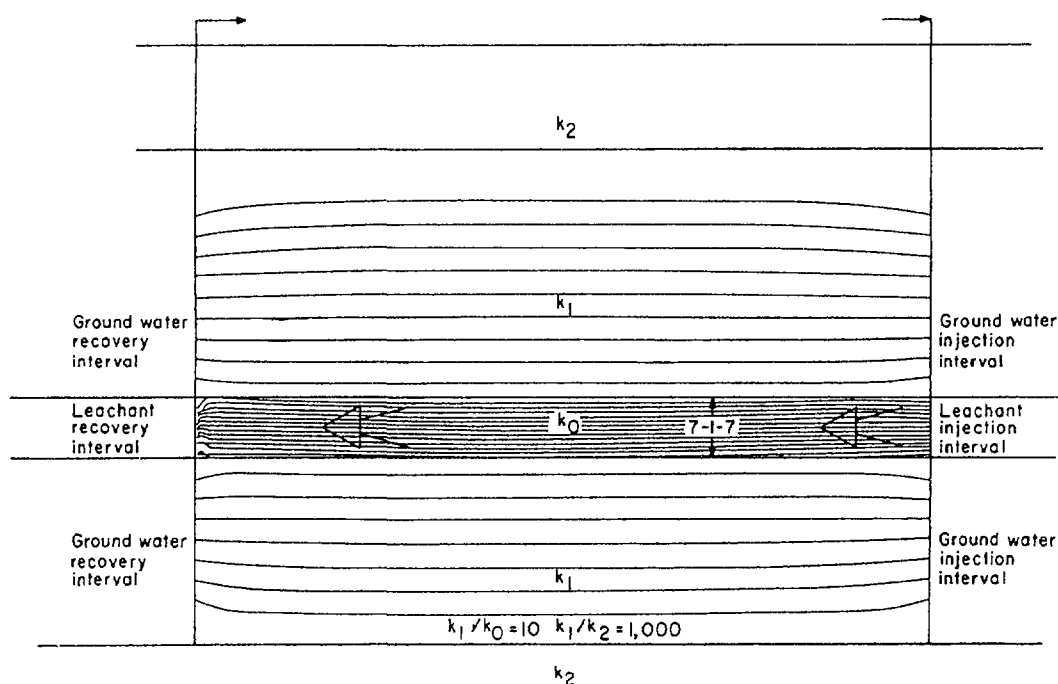

FIGURE 5. - Streamline pattern in a heterogeneous cross section with artificial confinement (26).

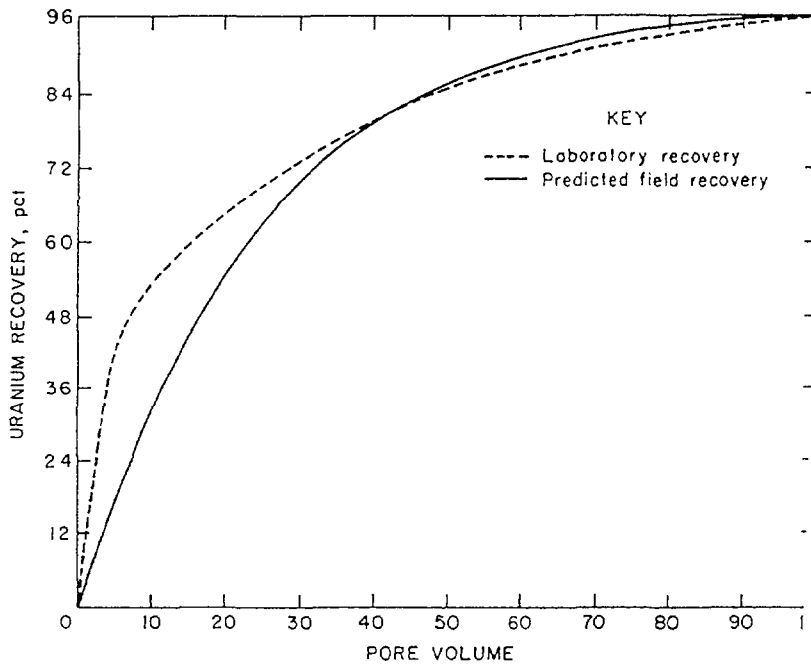

FIGURE 6. - Fractional uranium recovery with homogeneous ore and one-dimensional flow (26, 27).

In reference to figures 5 and 6, Schmidt (26,28) explains the method of confining leach solution to the mineralized zone through injection and recovery of ground water in the overlying and underlying barren zones, coincident with injection and recovery of leach solution in the mineralized zone. In figure 5, the value block [7-1-7] denotes that streamlines shown in figure 3 are confined to the mineralized zones. Coincident ground water and leach solution injection (or recovery) is accomplished by means of nested injection (or recovery) wells. Nested well designs that permit independent control of the injection and recovery rates in barren and mineralized zones are described in the patent application (28).

ENVIRONMENTALLY ATTRACTIVE LEACH SOLUTIONS

The Bureau funded research by the University of Texas at Austin to develop a leach solution for in situ uranium mining that avoids the restoration problems of ammonium carbonate and the clay swelling of sodium carbonate. Details leading to the research accomplishments reported here are found in the four contract-report volumes (29-32) and references (33-35)

Schechter (30) describes packed column leaching tests measuring the rate and ultimate yield of uranium and pyrite leaching under conditions representative of carbonate in situ uranium leaching. Leach solution cation, pH, and carbonate concentration had little effect on uranium leaching, but the leaching rate was approximately proportional to the square root of the oxygen concentration. The insensitivity to cation type led to a new process whereby the leach solution is preceded by a preflush containing the chloride of the leaching cation. This preflush prevented permeability losses associated with calcium carbonate precipitation and clay swelling caused by sodium. Preflushing of the ore body with a chloride solution of potassium was found to reduce formation damage by calcium carbonate precipitation. A further advantage is that the cation exchange capabilities of the formation are satisfied with a less expensive source of cation. That is, since potassium chloride is much less expensive than either potassium carbonate or bicarbonate, leaching costs may be reduced through the use of potassium chloride as a source of potassium for the clays.

Schechter (31) describes the development and application of PHASEQ/FLOW, a geochemical flow simulator capable of describing the dynamic changes in chemical composition of an aqueous solution during flow in a permeable medium. The solution components can react through intraaqueous reactions, redox, precipitation, or dissolution. The assumption of local thermodynamic equilibrium ensures maximum generality with respect to the number of species and components possible; however, the fluid flow itself is limited to one dimension. This report describes several applications: (1) generic batch equilibrium, (2) flowing equilibrium, (3) uranium roll front deposition, and (4) roll front leaching.

A field minitest was developed involving an injection-production (push-pull) well and at least two observation wells for detecting the

arrival of injected fluid and leached minerals (29). The goals of this test were to determine the amenability of the host formation to in situ mining, identify anisotropic flow, measure parameters for scaling the process, and predict the amount of flushing required for restoration. The minitest is simple operationally and can be completed in several weeks. With the correct design and interpretation, it can return to the operator information needed to evaluate economics, to ensure satisfactory leaching performance, to scale to larger operations, and to identify restoration problems.

A field test was conducted using the aforementioned push-pull minitest, a potassium chloride preflush (33), and a potassium carbonate leach solution; results are summarized in (32, 34). The test was carried out at the Intercontinental Energy Corporation (IEC) Zamzow site in South Texas. A high uranium concentration, over 200 ppm, during the production phase demonstrated the effectiveness of the leach solution. Even though a high degree of inhomogeneity in the permeability (and hence, the flow pattern) exists, the test data allowed calculation of the cation exchange capacity and cation distribution coefficients.

Data from the field test at the Zamzow site were analyzed with the computer model of cation exchange previously reported by Schechter (29). The results are reported in reference (35). The purpose was to examine the validity of the model and the corresponding analysis procedure. The results showed that the original procedure had to be modified somewhat to be most useful. However, the modified analysis procedure was quite successful in determining the values of the desired cation exchange parameters. A Bureau Technology News (36) capsulizes the field test procedure and the data analysis applied to the Zamzow field data. The procedures reliably measure cation exchange capacity, estimate distribution coefficients, and measure the hydrologic dispersivity of the

exchanging cations. The field test measures best what the laboratory tests measure poorly (exchange capacity) or not at all (dispersivity). The field test should prove to be a useful tool in improving the reliability of modeling ground water restoration quality following in situ mining (36).

WELL CONSTRUCTION AND COMPLETION

The Bureau investigated technologies for determining the integrity of in situ mining wells (2, 37-38). A trailer-mounted well integrity testing system (WITS) was built that uses a winch and steel cable to run inflatable packers in and out of the well (fig. 7). The WITS allows rapid testing of well casings as required by environmental regulations. A schematic of the test configuration is shown in figure 8. The WITS uses two inflatable packers to seal off part or all of the casing length. Water pressure is increased between the packers to the desired test pressure, and the presence or absence of casing leaks is ascertained by monitoring the pressure drop between the packers.

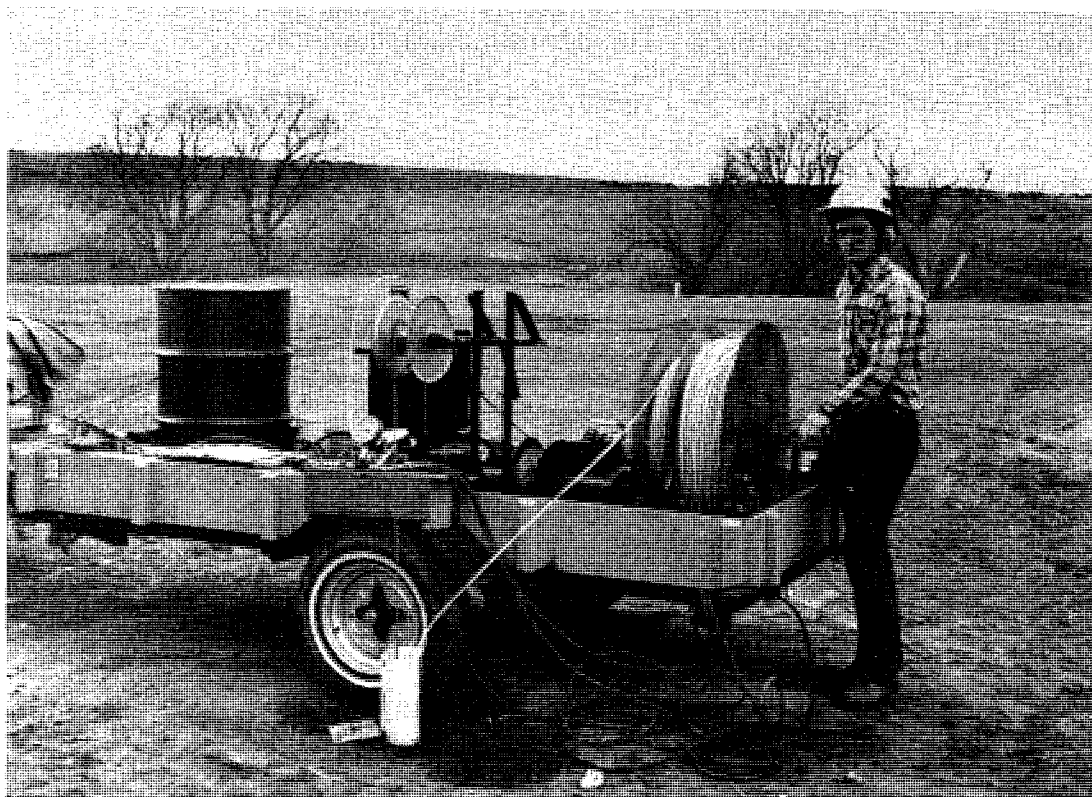

FIGURE 7. - Well integrity testing system (37).

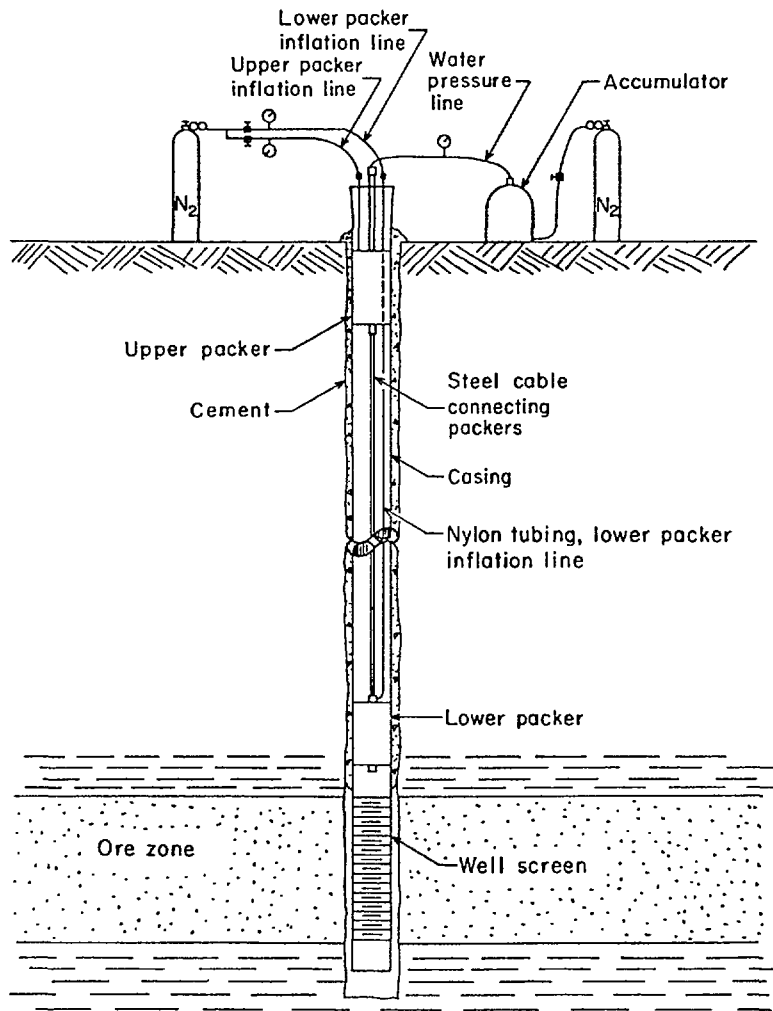

FIGURE 8. - Double-packer test configuration (37).

The WITS underwent an industry field test at the Irigaray in situ uranium leaching mine near Buffalo, WY (38). Thirty seven wells, with an average depth of 225 ft, were tested at an average rate of four wells per 8-h shift with a two-person operating crew. This represents a 75-pct time savings and an 83-pct labor savings compared to the rigid-pipe test method previously used at the mine, with which a three-person crew tested an average of one well per shift. The WITS performed well without equipment failure and was able to distinguish between wells that leaked and wells that were sound.

The Bureau evaluated nontypical well bore configurations such as branch wells for in situ mining of uranium deep deposits. Maurer Engineering Inc., under Bureau Contract J0199113, developed three branch well systems

(fig. 9) and two horizontal hole (slant or drain hole) systems (39).
Figure 10 shows the drain hole system. Four patents were granted as a
result of the work (40-43).

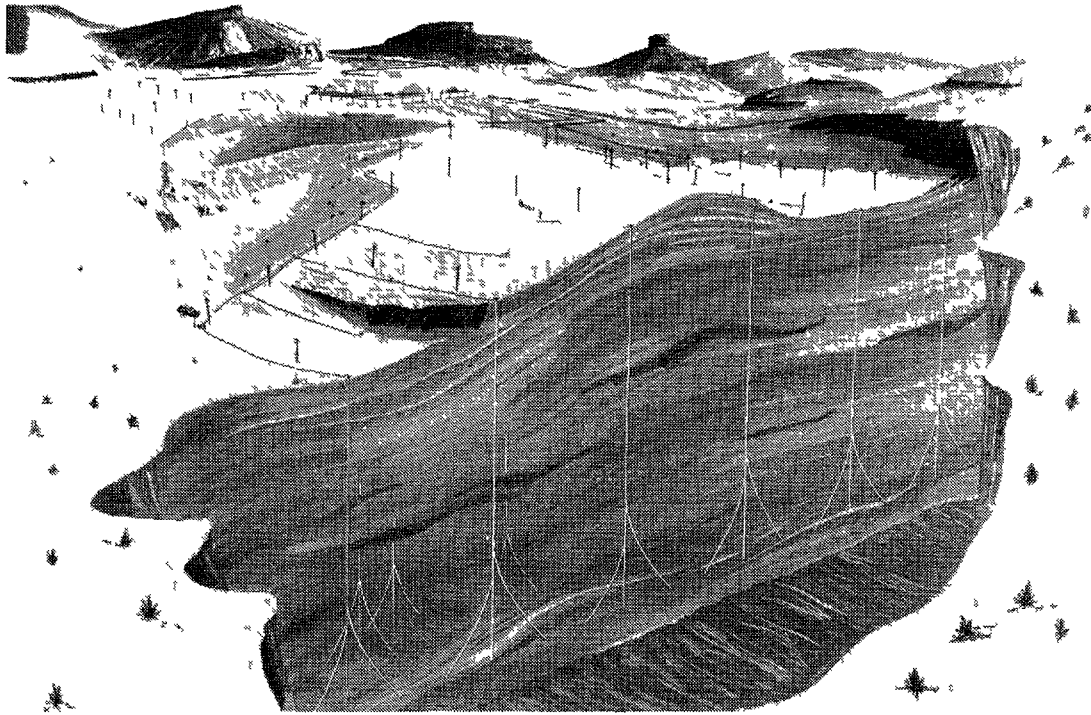

FIGURE 9. - Conceptual production scheme using branched boreholes (39).

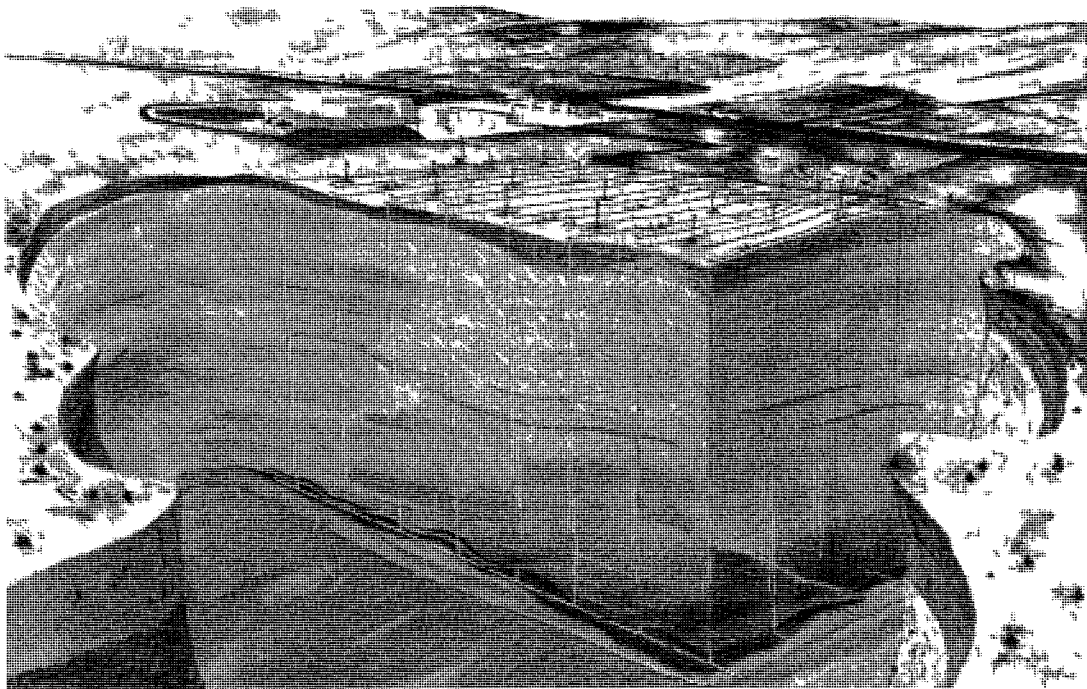

FIGURE 10. - Conceptual production scheme using horizontal drain holes (39).

Two other related patents are concerned with using branch wells for in situ mining (44-45). The first patent (44) describes whipstocking multiple branch wells from a single main vertical well. The second patent (45) discusses a method where alternating rows of vertical injection and recovery wells are drilled to the mineral-bearing stratum and then two horizontal branch wells (drain holes) are drilled at the bottom of each of these wells.

Branch well drilling can reduce well costs when applied to ore bodies deeper than 1,500 ft (39). The practical limit for number of branches drilled and completed from one vertical wellbore is three (fig. 9). The first logical step in developing branch well completion equipment is to limit branch wells to include only two-hole bottoms. Completion experience gained by developing templates and guides for dual-branch wells can be extended to completing three hole bottoms. The preferred concept worthy of further engineering study and development is the triple-branch well injection and recovery system out of a 9-5/8-in casing (39). This system can reduce well costs as much as 30 pct when applied to ore bodies 2,000 ft deep and as much as 44 pct when applied to ore bodies 5,000 ft deep. This particular concept can also be adapted for dual branched wells.

Horizontal drain hole wells have been successfully drilled, and equipment is available to drill drain holes with radius of curvature as short as 19 ft (39). The completion of such short radius drain holes for in situ mining would require use of special flexible pipe that has not previously been used for casing, and the development of specialized cementing equipment is required to adequately isolate the ore body. The drain hole offers apparent cost incentives at depths greater than 1,500 ft (39). One 200-ft drain hole effectively replaces two conventional wells. Figure 10 is a conceptual production scheme using horizontal drain holes.

Slant hole completions (where the hole is horizontal in the ore zone) can be designed with conventional oil well equipment (39). At depths greater than 1,500 ft, a slant hole penetrating 400 ft of ore could significantly reduce well costs by replacing four conventional wells. The primary limitation is the need to accurately know depth, thickness, and dip of the ore body. The surface well location is typically displaced more than 1,000 ft from the downhole entry point into the ore body. Inaccurate subsurface mapping or directional drilling error could result in missing the ore body or inadvertently exiting from the ore into adjacent formations. However, the technique is suitable to deeper, relatively thin ore beds.

COST AND SENSITIVITY ANALYSIS FOR URANIUM IN SITU MINING

The Bureau developed a computerized uranium in situ mining cost model under contract with the NUS Corporation (46-47). This model will generate capital and operating costs as well as perform discounted cash flow analyses for specified project conditions. Figure 11 shows the overview of the cost model structure. The cost analyses procedure and cost data base from this research effort have been developed over a period of approximately 1 year. Activities included visiting nine operating projects, making phone contacts with many other operators, soliciting cost

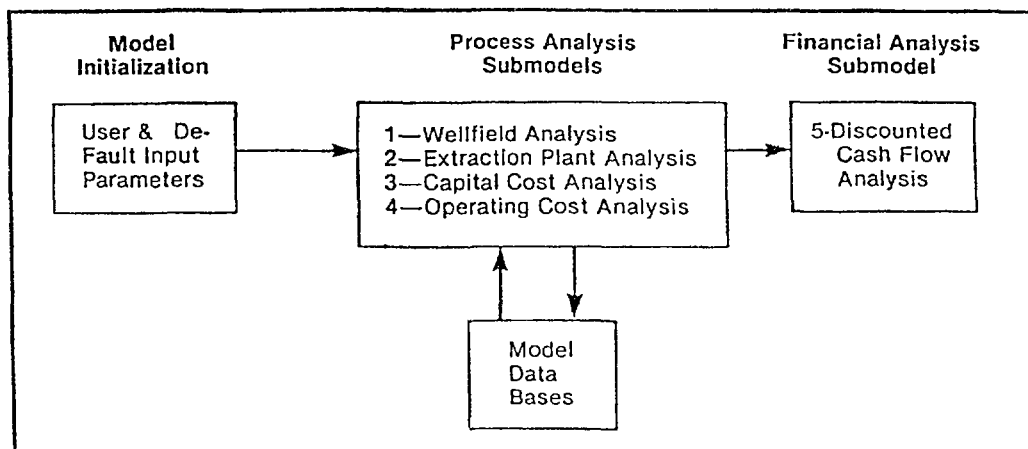

FIGURE 11. - Overview of the cost model structure (46, 47).

data from manufacturers and vendors, and drawing upon project team operating experience and in-house data. The cost model has the following features:

1. Develops detailed capital and operating requirements for the life of the project.
2. Solves for minimum required sales revenue per pound U_3O_8 (production cost) or rate of return on equity.
3. Contains regionalized data base for both Texas and Wyoming site applications.
4. Allows for cost analyses applications when only minimal information is known, as well as for cases in which detailed project data are available.
5. Accepts and accounts for either static or dynamic site conditions throughout project life.
6. Accepts user-specified capitalization structure options.

This original computer cost model contains data base information related to the Wyoming Basin region and the South Texas trend area. The Bureau expanded the data base to include changes for the San Juan Basin (New Mexico) type deposits. The existing computer software was modified to provide this additional information. This enhancement of the original cost model is significant because of increased capability to include one of the largest uranium producing areas in the United States. The cost model may be used to predict costs for areas other than Wyoming, Texas, and New Mexico as long as user and default input parameters and certain algorithms are modified to reflect the site-specific case.

BUREAU OF MINES REFERENCE AVAILABILITY

Copies of patents may be purchased from the U.S. Patent and Trademark Office, Washington, DC 20231.

If a pertinent Bureau of Mines Special Publication (SP), Report of Investigations (RI), or Information Circular (IC) is free, application

should be made to Publication Distribution, Bureau of Mines, Cochran's Mill Road, P.O. Box 18070, Pittsburgh, PA 15236. If the Bureau report is determined to be a sales publication, then the document may be purchased from the Superintendent of Documents, U.S. Government Printing Office, Washington, DC 20242.

If a reference has a NTIS PB accession number given with it, the publication may be purchased from the National Technical Information Service (NTIS), U.S. Department of Commerce, Springfield, VA 22161.

Open File Reports (OFR) without the NTIS accession number can be inspected at Bureau field facilities or the U.S. Department of the Interior, Natural Resources Library in Washington, DC; also the Bureau author (technical project officer for contract reports) can be contacted for OFR information.

SUMMARY

The purpose of the paper is to give an updated overview of uranium in situ mining research conducted and reported by the Bureau and coordinated predominantly at the Twin Cities Research Center (TCRC). In the report, research accomplishments are covered in the following topical sections: (1) permeability of uranium bearing sandstone, (2) environment and restoration of ground water, (3) fluid flow and geochemical modeling, (4) environmentally attractive leach solutions, (5) well construction and completion, and (6) cost and sensitivity analysis for uranium in situ mining. Additional details are found in the references cited. In a separate section, information is also provided on how to obtain copies of the Bureau references.

ACKNOWLEDGEMENTS

The authors wish to thank Jon K. Ahlness, mining engineer; Robert D. Schmidt, hydrologist; and Daryl R. Tweeton, research physicist, of the Bureau's Twin Cities Research Center, Minneapolis, MN, for their help in

interpreting the technical information that led to the reported research results. The authors also wish to thank them for providing updated unpublished information.

REFERENCES

1. Larson, W. C. Uranium In Situ Leach Mining in the United States. BuMines IC 8777, 1978, 68 pp.
2. Ahlness, J. K., S. C. Gould, and M. Pojar. A Technology for Integrity Testing of In Situ Leach Mining Wells Using a System of Inflatable Packers. BuMines RI 8952, 1985, 14 pp.
3. Olson, J. J. Bureau of Mines Research in In Situ Leaching and Borehole (or Slurry) Mining. Soc. Min. Eng. AIME preprint 77-AS-340, 1977, 58 pp.
4. Olson, J. J. In Situ Mining Technology for Uranium--A Progress Report on Bureau of Mines Research. Paper in Mining Technology for Energy Resources, Advances for the '80's, ed. by A. H. Jones (Proc. Conf., Houston, TX, Nov. 6-9, 1978). ASME, 1978, pp. 35-46.
5. Larson, W. C. Uranium In Situ Leach Mining--Environmental Controls. Paper in First International Conference on Uranium Mine Waste Disposal, ed. by C. O. Brawner (Vancouver, BC, Canada, May 19-21, 1980). AIME, 1980, ch. 15, pp. 175-192.
6. Staff--Bureau of Mines. In Situ Mining Research, Proceedings: Bureau of Mines Technology Transfer Seminar, Denver, CO, August 5, 1981. BuMines IC 8852, 1981, 107 pp.
7. University of Utah Research Institute (UURI) (Salt Lake City, UT). In Situ Leaching and Solution Mining: State of the Art and Recommended Research. Summary Report--Phase I (contract J0113094 and outside sources). BuMines OFR 64(1)-85, 1983, 175 pp.
8. Langen, R. E., and A. L. Kidwell. Geology and Geochemistry of the Highland Uranium Deposit, Converse County, WY. The Mountain Geol., v. 11, No. 2, 1974, pp. 85-93.
9. O'Rourke, J. E., R. J. Essex, and B. K. Ranson. Field Permeability Test Methods With Applications to Solution Mining (contract J0265045, Woodward-Clyde Consultants). BuMines OFR 136-77, 1977, 180 pp.; NTIS PB 272 452.
10. Chamberlain, P. G. Field Permeability Methods for In Place Leaching. Min. Congr. J., v. 64, No. 9, 1978, pp. 22-25.
11. Ahlness, J. K., D. I. Johnson, and D. R. Tweeton. Effect of Drilling Fluids on Permeability of Uranium Sandstone. BuMines RI 8914, 1984, 16 pp.
12. Brierley, C. L., and J. A. Brierley. Investigation of Microbially Induced Permeability Loss During In Situ Leaching (contract S0211032, NM Inst. of Min. and Technol.). BuMines OFR 90-83, 1982, 69 pp.; NTIS PB 83-205534.

13. Yates, M. V., J. A. Brierley, C. L. Brierley, and S. E. Follin. Effect of Microorganisms on In Situ Uranium Mining. *Applied and Environmental Microbiology*, v. 46, No. 4, Oct. 1983, pp. 779-784.
14. Hjelmsstad, K. E. Effect of Clay Stabilizers on Permeability of Clayey Ore. BuMines RI 8902, 1984, 13 pp.
15. Grant, D. C., D. C. Seidel, and I. L. Nichols. Technique for In Situ Leach Simulation of Uranium Ores (contract H0262004, Westinghouse Electric Corp. Res. and Dev. Ctr.). BuMines OFR 192-84, 1985, 59 pp; NTIS PB 85-145902/AS.
16. Sundar, P. S. In Situ Leaching Studies of Uranium Ores--Phases I-III (contract H0262004 Westinghouse Electric Corp. Res. and Dev. Ctr.). BuMines OFR 140-77, 1977, 392 pp.; NTIS PB 272 3717/AS.
17. Grant, D. C. In Situ Leaching Studies of Uranium Ores--Phase IV (contract H0262004, Westinghouse Electric Corp. Res. and Dev. Ctr.). BuMines OFR 52-79, 1978, 497 pp.; NTIS PB 296 336/AS.
18. Grant, D. C. In Situ Leaching Studies of Uranium Ores--Phase V (contract H0262004, Westinghouse Electric Corp. Res. and Dev. Ctr.). BuMines OFR 84-81, 1980, 591 pp.; NTIS PB 81-222739.
19. Nigbor, M. T., W. H. Engelmann, and D. R. Tweeton. Case History of a Pilot-Scale Acidic In Situ Uranium Leaching Experiment. BuMines RI 8652, 1982, 81 pp.
20. Engelmann, W. H., P. E. Phillips, D. R. Tweeton, K. W. Loest, and M. T. Nigbor. Restoration of Groundwater Quality Following Pilot-Scale Acidic In Situ Uranium Leaching at Nine-Mile Lake Site Near Casper, WY. *Soc. Pet. Eng. J.*, v. 22, 1982, pp. 382-398.
21. Tweeton, D. R., G. R. Anderson, J. K. Ahlness, O. M. Peterson, and W. H. Engelmann. Geochemical Changes During In Situ Uranium Leaching With Acid. Paper in *In Situ Uranium Mining and Ground Water Restoration*, ed. by W. J. Schlitt and D. A. Shock (Proc. Symp., New Orleans, LA, Feb. 19, 1979). AIME, 1979, ch. 3, pp. 23-51.
22. Buma, G., P. H. Johnson, G. K. Bienek, C. G. Watson, H. Noyes, and R. Capuano. Analysis of Groundwater Criteria and Recent Restoration Attempts After In Situ Uranium Leaching (contract J0295019, Resour. Eng. and Dev. Inc.). BuMines OFR 90-82, 1981, 302 pp.; NTIS PB 82-246018.
23. Kehrman, R. F. Detection of Lixiviant Excursions With Geophysical Resistance Measurements During In Situ Uranium Leaching (contract J0188080, Westinghouse Electric Corp.). BuMines OFR 5-81, 1979, 156 pp.; NTIS PB 81-171324.
24. Tweeton, D. R. (assigned to U.S. Dep. Interior). Impedance Measuring Method and Apparatus for Detecting Escaping Leach Solution. U.S. Pat. 4,253,063, Feb. 24, 1981.
25. Schmidt, R. D. Computer Modeling of Fluid Flow During Production and Environmental Restoration Phases of In Situ Uranium Leaching. BuMines RI 8479, 1980, 70 pp.

26. Schmidt, R. D., and S. E. Follin. Geochemical Modeling of In Situ Leaching in a Heterogeneous Porous Medium. *Miner. and Metall. Processing*, v. 4, 1987, pp. 89-93.
27. Price, J. G., P. Bobeck, T. R. Guilinger, L. W. Lake, R. S. Schechter, D. E. Stover, and W. Mays. Case History of an In Situ Uranium Leaching Project. *Uranium*, v. 1, 1984, pp. 335-361.
28. Schmidt, R. D., and J. K. Ahlness. Improved Bedded Mineral Extraction Process. U.S. Pat. Application Serial No. 111246, Oct. 22, 1987.
29. Schechter, R. S., L. W. Lake, and M. I. Kabir. Development of Environmentally Attractive Leachants; Volume I, A Minitest for In Situ Uranium Leaching (contract H0282016, Univ. TX, Austin, TX). BuMines OFR 133-83, 1983, 314 pp.; NTIS PB 83-234497.
30. Schechter, R. S., L. W. Lake, and T. R. Guilinger. Development of Environmentally Attractive Leachants; Volume II, An Experimental and Theoretical Study of Uranium and Pyrite Dissolution Kinetics (contract H0282016, Univ. TX, Austin, TX). BuMines OFR 141-84, 1984, 548 pp.; NTIS PB 84-232669.
31. Schechter, R. S., L. W. Lake, and M. P. Walsh. Development of Environmentally Attractive Leachants; Volume III, Geochemical Flow Modeling (contract H0282016, Univ. TX, Austin, TX). BuMines OFR 108-85, 1985, 336 pp.; NTIS PB 86-110285.
32. Schechter, R. S., L. W. Lake, T. R. Guilinger, J. G. Price, and P. Bobeck. Development of Environmentally Attractive Leachants; Volume IV, A Minitest of an In Situ Uranium Leach Solution (contract H0282016, Univ. TX, Austin, TX). BuMines OFR 13-86, 1985, 150 pp.; NTIS PB 86-158789.
33. Breland, W. M., T. R. Guilinger, and R. S. Schechter (assigned to U.S. Dep. Interior). Preflush-Lixiviant Process for Solution Mining of Uranium Ore Beds. U.S. Pat. 4,340,253, July 20, 1982.
34. Guilinger, T. R., R. S. Schechter, L. W. Lake, J. G. Price, and P. Bobeck. A Minitest of an In Situ Uranium Leach Solution. *Soc. Min. Eng. AIME preprint* 84-80, 1984, 26 pp.
35. Tweeton, D. R., and L. W. Lake. In Situ Mining Push-Pull Field Test for Evaluating Cation Exchange Parameters. *Soc. Min. Eng. AIME preprint* 86-119, 1986, 12 pp.
36. U.S. Bureau of Mines. Field Test for Measuring Cation Exchange Parameters. *Technology News*, No. 267, Dec. 1986, 2 pp.
37. Ahlness, J. K. Well Integrity Testing System for In Situ Leach Mining Wells. *Soc. Min. Eng. AIME preprint* 86-7, 1986, 6 pp.
38. Ahlness, J. K. Well Integrity Testing System for In Situ Leach Mining Wells. *Miner. and Metall. Processing*, v. 4, 1987, pp. 40-43.
39. Dareing, D. W., E. T. Wood, and D. H. Davidson. Evaluation of Branch and Horizontal Boreholes for In Situ Leach Mining (contract J0199113, Maurer Engineering, Inc.). BuMines OFR 34-84, 1984, 149 pp.; NTIS PB 84-165869.

40. Rehm, W. A., D. W. Dareing, and E. T. Wood. Triple Branch Completion With Separate Drilling and Completion Templates. U.S. Pat. 4,415,205, Nov. 15, 1983.
41. Wood, E. T., D. W. Dareing, W. C. Larson, and R. Snyder. Multiple Branch Well Containing One Producer and One Injector Well. U.S. Pat. 4,396,230, Aug. 2, 1983.
42. Wood, E. T., D. W. Dareing, R. Snyder, and W. C. Larson. Multiple Branch Completion With Common Drilling and Casing Template. U.S. Pat. 4,396,075, Aug. 2, 1983.
43. Wood, E. T., R. Snyder, W. C. Larson, and D. W. Dareing. Method and Apparatus To Complete Horizontal Drain Holes. U.S. Pat. 4,402,551, Sept. 6, 1983
44. Larson, W. C., and R. J. Morrell (assigned to U.S. Dep. Interior). In Situ Leach Mining Method Using Branched Single Well for Input and Output. U.S. Pat. 4,222,611, Sept. 16, 1980.
45. Morrell, R. J., W. C. Larson, and R. D. Schmidt (assigned to U.S. Dep. Interior). Method of In Situ Mining. U.S. Pat. 4,249,777, Feb. 10, 1981.
46. Toth, G. W., and J. R. Annett. Cost and Sensitivities Analysis for Uranium In Situ Leach Mining (contract J0199112, NUS Corporation). BuMines OFR 97-82, Mar. 1981, 342 pp.; NTIS PB 82-243965.
47. Toth, G. W., and W. C. Larson. Cost and Sensitivities Analysis of Uranium In Situ Mining. Paper in Interfacing Technologies in Solution Mining, ed. by W. J. Schlitt and J. B. Hiskey (Proc. Symp., Denver, CO, Nov. 18-20, 1981). AIME, 1982, ch. 25, pp. 291-298.

RESTORATION OF IN SITU LEACHED URANIUM ORES

A laboratory study of restoration reagents

D.C. GRANT, H.A. BURGMAN, D.C. SEIDEL

Bureau of Mines,
United States Department of the Interior,
Salt Lake City, Utah,
United States of America

Abstract

Ammonium bicarbonate has been used as the primary lixiviant in many in situ uranium mining operations. During the leaching operation, ammonium ions exchange with the cations of the ores clay fraction and, after mining is complete, may desorb into the ground water along with other elements. Laboratory column tests were used to evaluate the effect of various restoration reagents on the leakage levels of ammonium, uranium, and selenium ions. Aluminum chloride significantly reduced leakage levels and also increased ore bed permeability.

INTRODUCTION

In situ leaching has been an attractive means of recovering uranium from small or low-grade ore deposits. The process involves injecting a lixiviant, typically ammonium carbonate-bicarbonate and an oxidant into the uranium containing ore body. As the solution passes through the ore body, the uranium is oxidized from the insoluble plus four to the soluble plus six state. The uranium is then complexed with the anion of the lixiviant (carbonate-bicarbonate). The uranium-laden solution is removed from the ore body and the uranium recovered in an above ground processing plant.

During the mining process, the leach solution cation (ammonium) can exchange with sodium and calcium that are present on the ore's negatively charged clay fraction. The ammonium later equilibrates with the naturally occurring cations in ground water as the water comes in contact with the partially exchanged clay. Depending on regulatory requirements, the resulting

equilibrated water may need to be restored to some lower level. In addition, the oxidizing leach solution mobilizes various chemical species. The actual species mobilized will depend on the composition of the particular ore being leached. A laboratory study was undertaken to obtain a better understanding of the interaction of the leach solution and the underground environment, and to develop restoration methods.

Using a laboratory system developed for simulation of in situ leaching, exploratory tests were conducted on columns of ore to examine the use of the following solutions as restoration agents:

- 3.0 g/L AlCl₃
- 1.0 g/L LaCl₃ - La₂SO₄
- 1.0 g/L Na₂SiO₃
- 3.0 g/L NaHSO₃
- 3.0 g/L LiCl₃ - La₂SO₄
- 1.0 g/L Na₂SiO₃ - 2.0 g/L NaCl

The aluminum chloride was examined, for example, because it was postulated that the aluminum cation should remove the ammonium as shown by the following reaction:

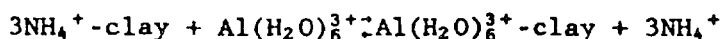

The exploratory column tests examined:

- The ammonium exchange on the ore during leaching
- Post-leach ion leakage into ground water
- The influence of the restoration agents on permeability
- The influence of the restoration agents on ion leakage.

The program was performed under contract to the U.S. Department of the Interior's Bureau of Mines, Washington, DC, with D. C. Seidel of the Bureau of Mines, Salt Lake City Research Center, as technical project officer. Complete data on all tests conducted in this program are documented in reports available through NTIS; Sundar (1977), Grant (1978), and Grant (1980) (1-3).

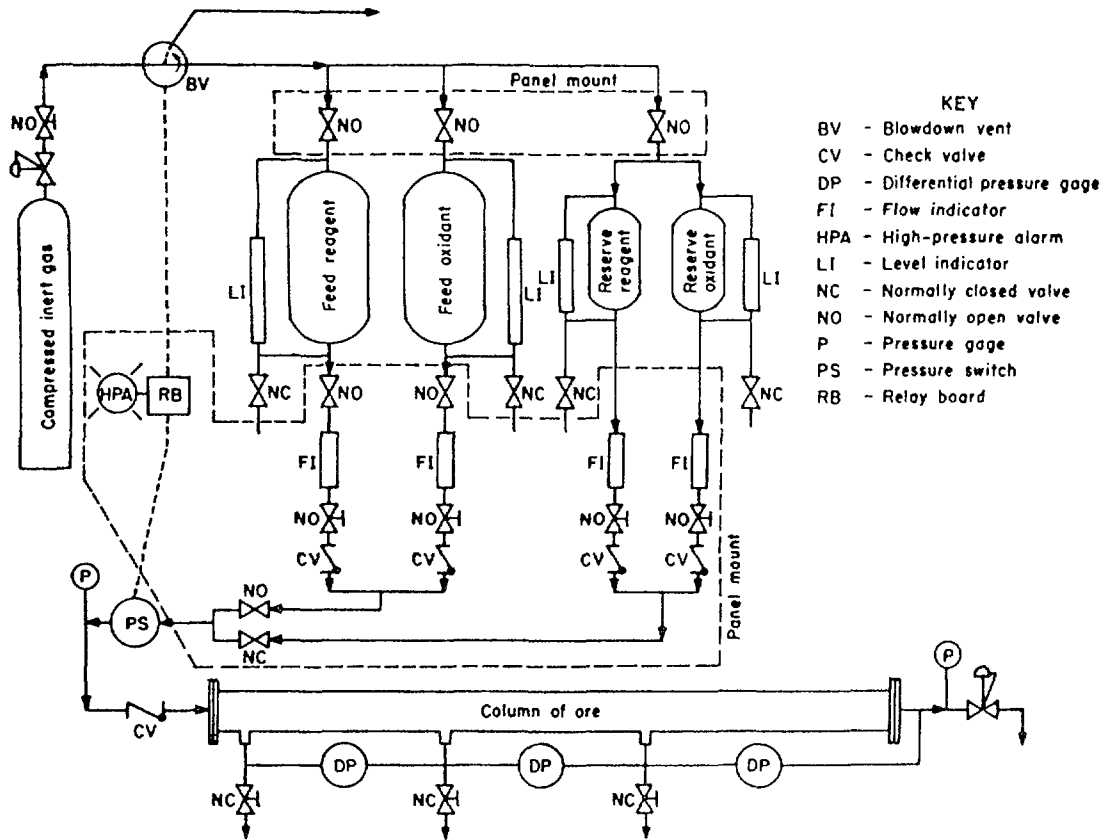

FIGURE 1. - Schematic diagram of in situ leaching system.

EXPERIMENTAL SYSTEM

A schematic diagram of the in situ simulation system used in this study is shown in figure 1. The system contains pressurized feed tanks from which the leach solution is fed into the ore column. The feed system consists of two primary 316 stainless steel 60-L tanks, having an allowable working pressure of 690 kPa. One tank contained a PVC liner that served to separate the pressurizing gas (nitrogen) from solutions (deionized water and ground water), in which gas saturation was not desirable. If these solutions and gas were not separated, the inert nitrogen saturating the solution would bubble out of solution in the lower pressure ore bed, thus causing permeability damage that would not occur in an actual field test. The PVC liner in the primary feed tank was removed in order to saturate the bicarbonate leach solutions with oxygen gas, the oxidant used in these tests. The flow from each tank was controlled with a needle valve and monitored by a flow meter.

The ore column consists of a 102-mm-diam and 4-m-long clear glass cylinder shown in figure 2. The glass structure, rated for a maximum allowable pressure of 345 kPa, permits visual inspection of the ore packing during testing. Monitoring and sampling along the length of the ore bed is accomplished with pressure taps and sampling probes in the T-sections that divide the ore column packing into three sections. Permeability is determined for each section by measuring the differential pressure across the sections.

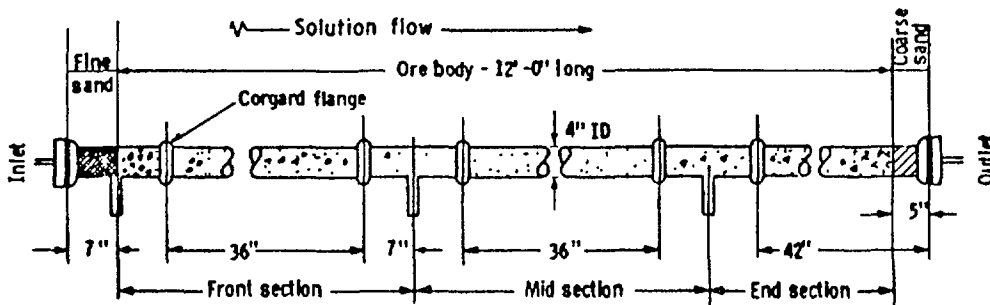

Fig. 2 - Low pressure glass column for in situ leach tests

For more complete information on the construction, design, and operation of the system's equipment, refer to the more comprehensive U.S. Bureau of Mines report (Sundar, 1977) (1).

SIMULATION TESTING METHOD

The ore used in this study was obtained from the Lucky Mc mine in Wyoming's Shirley Basin. The characteristics of the ore studied is given in table 1. The entire batch of ore was air dried, crushed, and ground to -1.7 mm (-10 mesh) and then blended together. Preparation of the ore in this manner facilitated packing and ensured the uniformity of samples used in the tests. Note that air drying will oxidize the ore to some degree. However, since ore is oxidized during the leaching process, the oxidation is not important in this study because it will not affect post leakage characteristics. Thus, leakage characteristics of the oxidized ore are of interest.

TABLE 1. - Wyoming ore characteristics

Fraction description	Weight, pct
U ₃ O ₈	0.10
CaO	1.12
MoO ₃	0.001
V ₂ O ₅	0.014
Fe	0.94
CO ₂	0.84
SO ₄	0.005
Total S	0.33
-325 mesh (dry screen)	4.9
-325 mesh (wet screen)	16.6
Clay fraction	9.1
U-distribution (dry screen)	54% in -48M (32%)
U-distribution (wet screen)	81% in -48M (39%)
U-minerals	not identified
Clay minerals	montmorillonite
Heavy minerals	chlorite, clinozoisite, pyrite, magnetite
Bulk sample mineralogy	quartz, feldspar, montmorillonite, mica
Feldspar-quartz ratio	1 + 2
Volcanic rock fragments	no
Rocks classification	Lithic Arcose

The processed ore was packed into a vertically placed column using a method that consistently produced permeabilities (0.05 to 2.5 darcy) representative of those in the field (Sundar, 1977) (1). After packing, the columns were inspected to make certain that no voids, faults, or gross segregations were present. The experiments were performed with the columns in a horizontal position to eliminate any gravity effects on solution flow, fines migration, and packing density variation due to the weight of packing.

A column test was started with a 150 hr deionized water flow period to ensure correct permeability and packing stability. During this initial flow period, the ore was wetted slowly (2 to 5 mL/min) to allow it to consolidate. After about 24 hrs, the flow was increased gradually during the next 24 hrs until the desired rate (10 mL/min or 1 fph) was obtained. About 20 pct of the uranium was removed during the deionized water flow. The water leaving the ore bed had a pH between 7 and 8.

After the permeability and stability of the packing was found acceptable, the 1 g/L ammonium bicarbonate leach solution saturated with oxygen at 345 kPa was introduced. A packing was acceptable if the permeability was within the

range considered proper for this ore (0.6 to 2 darcy) and if no cracks or ore compaction occurred. The reagent flow was carried out for about 750 hrs and initially at the desired rate (10 mL/min). However, as permeability dropped, the flow was constrained by the maximum allowable operating pressure; 345 kPa for the glass columns.

GENERAL RESULTS

Overall results from the exploratory tests are shown in figures 3, 4, and 5. Figure 3 summarizes the effect of the various restoration solutions on permeability after NH_4HCO_3 leaching. Most of the solutions initially improved permeability, but the improvement varied significantly. The AlCl_3 and the NaHSO_3 produced dramatic initial permeability improvements, but the NaHSO_3 showed an almost as rapid decline with continued flow. The $\text{LaCl}_3\text{-La}_2\text{SO}_4$ solution also improved the bed permeability.

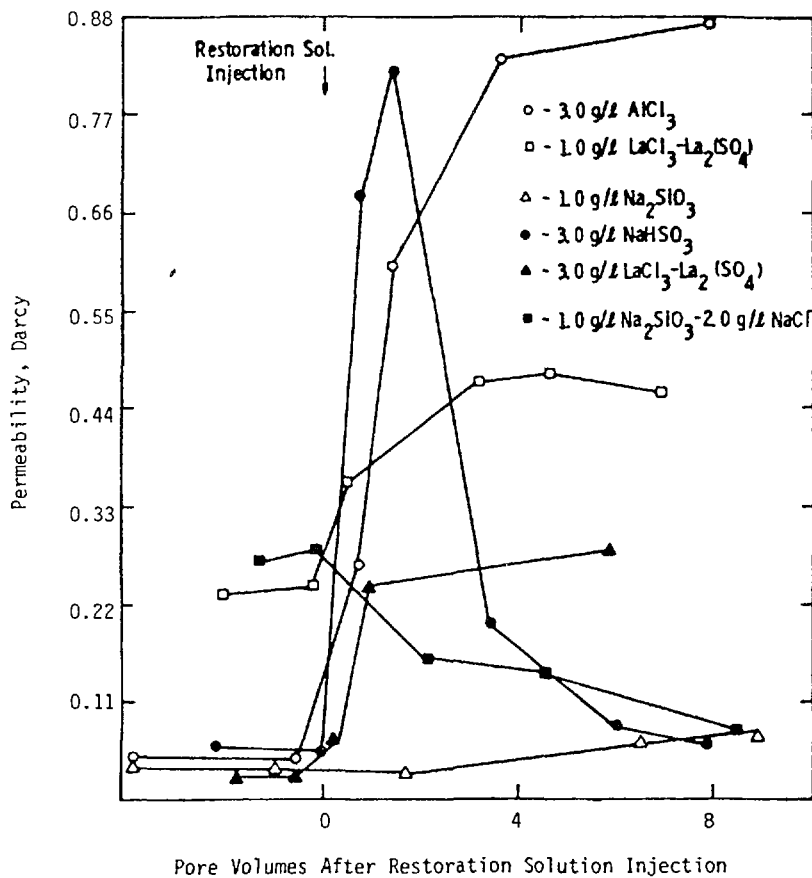

Fig. 3 - Effect of various restoration solutions on permeability after leaching with 1.0 g/l NH_4HCO_3

The effect of the restoration solutions on permeability during subsequent ground water flow is shown in figure 4. When the simulated ground water was introduced after the AlCl_3 and $\text{LaCl}_3\text{-La}_2\text{SO}_4$ contacts, there was a decline in permeability, but it stabilized much above the baseline results.

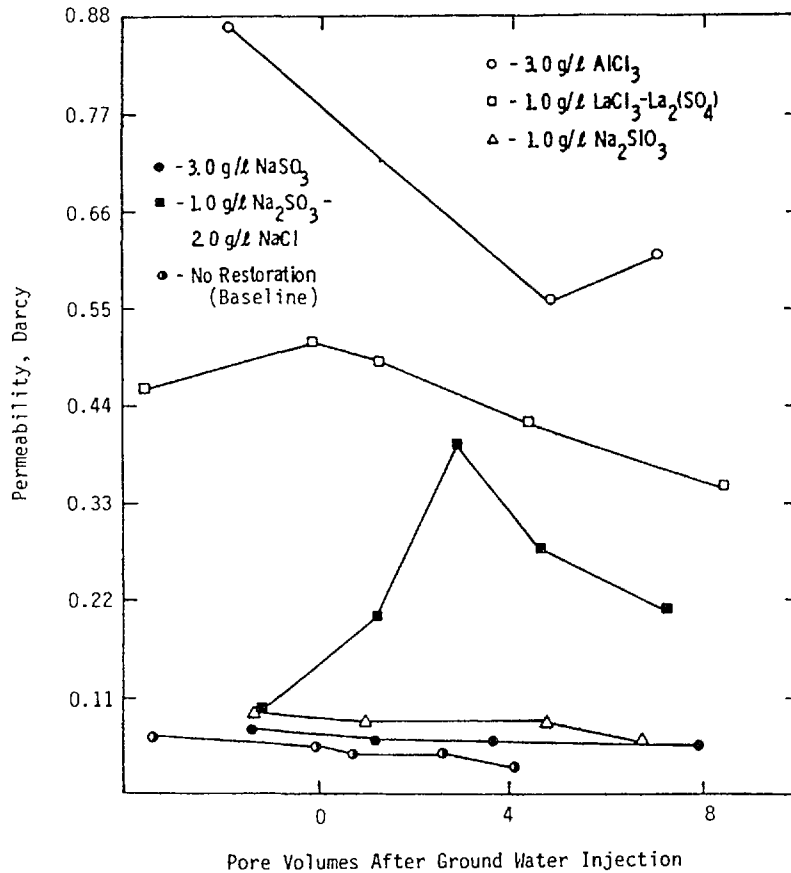

Fig. 4 - Effect of chemical restoration on subsequent ground water permeability

A comparison of the ammonium removal rates for the various chemicals is shown in figure 5. Of the solutions examined, the most rapid removal was obtained with the 3.0 g/L AlCl_3 (67.4 meq of A). The trivalent aluminum was much more effective than the trivalent lanthanum. The removal with aluminum was about twice as great as that of the 3.0 g/L $\text{LaCl}_3\text{-La}_2(\text{SO}_4)_3$ (34.2 meq/L). Although the aluminum equivalent concentration was about twice that of the lanthanum, doubling the lanthanum concentration would not result in as high an ammonium removal as the aluminum. A three-fold increase in the lanthanum equivalent concentration only increased the ammonium removal rate by about 50 pct.

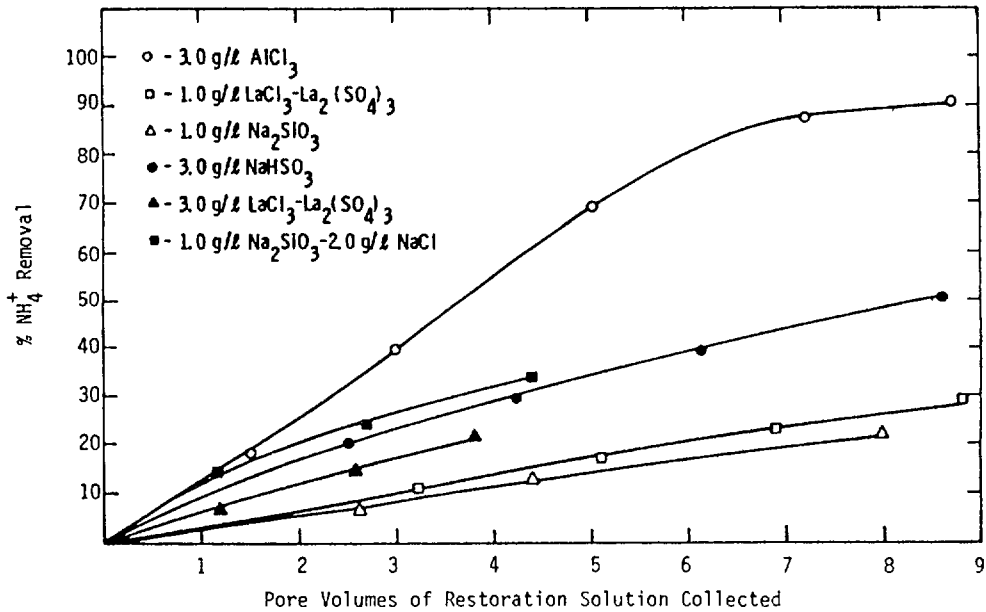

Fig. 5 - Ammonium removal from 1.0 g/l NH₄HCO₃ leached Wyoming ore using various chemical solutions

SPECIFIC ALUMINUM CHLORIDE RESULTS

The AlCl₃ restoration technique produced the most favorable overall results. The following discussion presents a specific comparison of the AlCl₃ treatment with a ground water only restoration. In test 1, only simulated Wyoming ground water was passed through the ore body following the leach. The composition of the ground water used is given in table 2. This test was performed to establish baseline chemical leakage levels. In test 2, which had the same leach conditions as test 1, 3 g/L aluminum chloride (pH - 3.5) was passed through the ore body immediately following the leach solution. Simulated ground water flow then followed the restoration solution.

TABLE 2. - Synthetic ground water composition*

440 mg/L NaHCO ₃
280 mg/L Na ₂ SO ₄
100 mg/L CaCl ₂
*pH adjusted to 8 with NaOH.

The ammonium sorption and uranium residue data for the two tests are given in table 3. The results show that at the conclusion of leaching, the ammonium sorption characteristics and uranium levels were essentially the same

for both columns of ore. That is, at the end of ammonium bicarbonate leaching, both ore columns had an ammonium concentration of 1.0 mg NH₄⁺/g of ore and a uranium level of 0.3 mg/g of ore.

TABLE 3. - Ammonium and uranium levels at conclusion of leaching

Test No.	Post leach solution	Total volume leach solution injected, L	NH ₄ ⁺ ore level mg/g of ore	NH ₄ ⁺ solution level, mg/L of solution	U ore level mg/g of ore	U solution level, mg/L of solution
1	Grd. H ₂ O (pH = 8)	364	1.0	164	0.3	17
2	3.0 g/L AlCl ₃ (pH = 3.5)	348	1.0	141	0.3	14

As shown in table 4, the ammonium, uranium, and selenium leakage levels into the post-leach ground water in test 1 were relatively high for the particular ore studied. After eight pore volumes of ground water, the ammonium level was still 140 mg/L, uranium was 12 mg/L, and selenium was 0.14 mg/L. Leakage of these ions during the post-leach aluminum chloride flow (test 2) is given in table 4. After eight pore volumes of restoration solution, the uranium level in the ground water was 1 mg/L, the selenium level was 0.05 mg/L, and the ammonium level was 400 mg/L. The high ammonium level indicated that the aluminum was still removing significant amounts of ammonium from the ore. During the aluminum chloride flow, the pH of the solution collected declined from 7.5 to 6.5. With subsequent ground water flow (five pore volumes), the selenium leakage dropped to less than 0.002 mg/L, the ammonium dropped to 3 mg/L, and the uranium stayed at about 1 mg/L; thus, the aluminum chloride greatly reduced the leakage of these chemicals. The pH of the ground water collected was about 7.

TABLE 4. - Effect of AlCl₃ on chemical leakage after leaching

Chemical leakage after 8 pore volumes of solution							
Test No.	Post-leach solution	Uranium, mg/L	Ammonium, mg/L	Selenium, mg/L	Aluminum, mg/L	Chloride, mg/L	pH
1	Grd. H ₂ O	12	140	0.14	--	65	8.2
2	1) AlCl ₃	1	400	0.05	<1	2,550	6.5
	2) Grd. H ₂ O	1	3	<0.002	<1	100	6.8

The aluminum chloride also caused an unexpected change in the permeability of the ore body. As shown in figure 6, the permeability increased dramatically with the injection of aluminum chloride. This compares to the gradual decline in permeability experienced with post-leach ground water (test 1). This improvement would reduce pumping or injection costs and improve the accessibility of the ore that would likely lead to more rapid and more complete restoration.

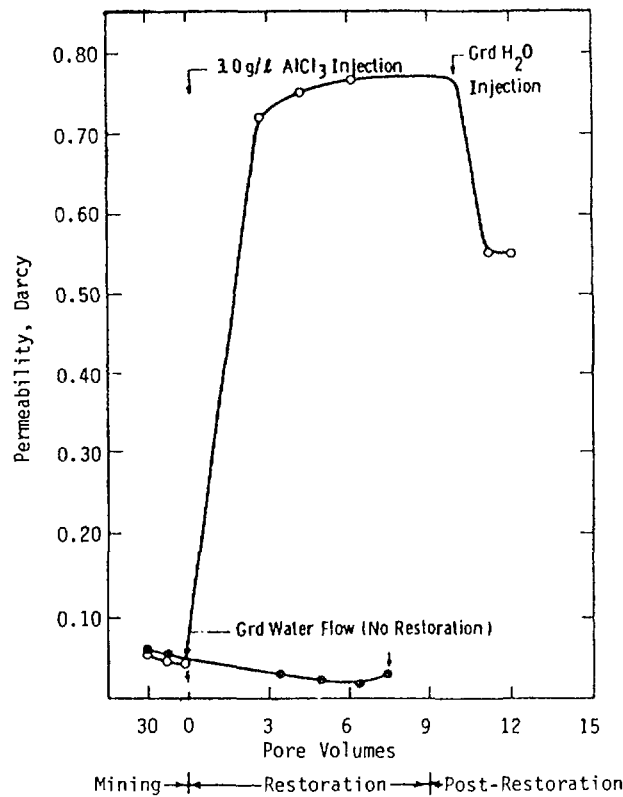

Fig. 6 - Effect of AlCl₃ restoration on post-leach permeability

DISCUSSION OF AlCl₃ RESULTS

The large decline in ammonium leakage with aluminum chloride restoration is the direct result of the high ammonium removal achieved during the aluminum chloride flow. Over 90 pct of the ammonium on the ore was removed in 10 pore volumes of the aluminum chloride. The aluminum resulted in rapid ammonium removal. Thus, little ammonium was left to desorb into subsequent ground water flow. The probable need for this ammonium restoration is shown in

figure 7. Without restoration, the ammonium level in the ground water remains above 50 mg/L for over 30 pore volumes. With aluminum chloride restoration, the ammonium is removed rapidly from the clay, thus, the ammonium level in the ground water drops relatively quickly to very low levels.

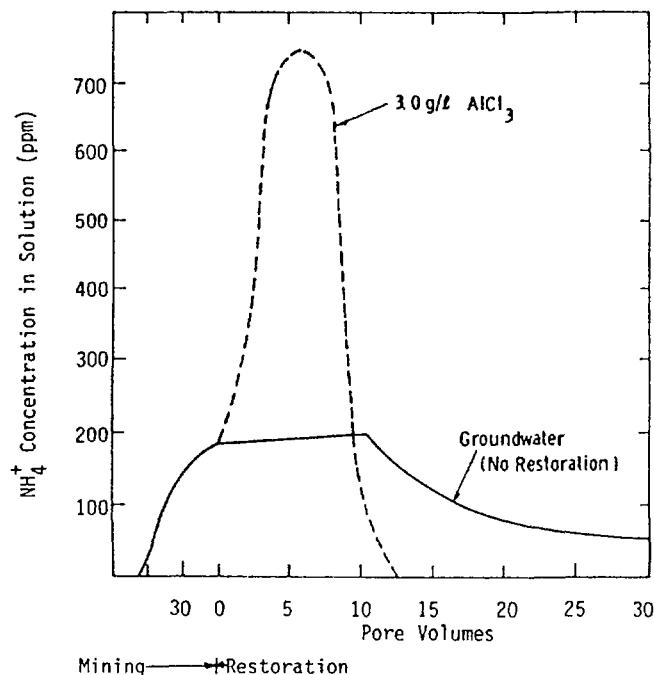
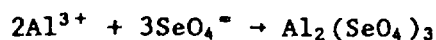

Fig. 7 - Effect of AlCl_3 restoration on NH_4^+ leakage from 1.0 g/l NH_4HCO_3 leached ore

The significant reduction in the leakage of uranium and selenium is more difficult to explain. Their reduction is likely caused by coprecipitation with aluminum. For example, the selenium may have precipitated according to the following reaction:



Uranium may also have precipitated in an analogous manner.

The dramatic improvement in permeability with AlCl_3 may have had several causes. The exchange of aluminum onto clay particles, as well as the high ionic strength of the aluminum chloride solution, would greatly reduce the permeability damaging effects of clay dissociation and dispersion. Studies by Reed (1972) have shown that hydroxy-aluminum solutions stabilize the clay in the ore. Also, the aluminum chloride may have reduced the oxygen gas blockage that is produced during leaching. The aluminum may have coated the ore as

hydroxy-aluminum, which along with opening the pores due to the reduced clay dispersion, may have allowed the gas to pass more easily through the ore body.

It is also important to note that the aluminum chloride does not complicate the restoration. As shown in table 4, there was essentially no aluminum in the post-restoration ground water, and the chloride level dropped rapidly. The aluminum is not a restoration complication because the trivalent aluminum will not readily exchange with the monovalent and divalent ground water cations, and also because the aluminum would quite likely precipitate at the ground water pH \approx 8. Because no sorption interaction occurs between the chloride and the ore body, acceptable chloride levels can be obtained relatively rapidly by just sweeping the ore body with ground water.

Aluminum chloride was shown to be an effective agent for post-leach removal of ammonium from the Wyoming ore tested; this removal significantly reduced leakage into ground water. The leakage of uranium and selenium was also reduced, and bed permeability was improved. Other ores may respond differently, and specific testing is recommended. Also, combination treatments such as AlCl_3 followed by NaHSO_3 could be effective for some ore bodies.

REFERENCES

1. Sundar, P. S., In Situ Leaching Studies of Uranium Ores - Phases I Through III, U.S. Bureau of Mines Open File Report 140-77, 1977, 392 pp.; Contract No. H0262004, NTIS Report No. PB 272 3717/AS, June 1977.
2. Grant, D. C., In Situ Leaching Studies of Uranium Ores - Phase IV, U.S. Bureau of Mines Open File Report 52-79, 1979, 497 pp.; Contract No. H0262004, NTIS Report No. PB 296 336/AS, November 1978.
3. Grant, D. C., In Situ Leaching and Restoration Studies of Uranium Ores - Phase V, U.S. Bureau of Mines Open File Report 84-81, 1981, 591 pp.; Contract No. H0262004, NTIS Report No. PB 81-222739, May 1980.

ADAPTING URANIUM IN SITU MINING TECHNOLOGY FOR NEW COMMERCIAL OPERATIONS

A.H. MONTGOMERY
Canonie Environmental Services Corporation,
Englewood, Colorado,
United States of America

Abstract

The vast majority of uranium produced commercially in the United States by in-situ leach methods has come from the South Texas deposits. The technology is applicable to deposits in other parts of the United States with some modifications. This paper reviews the technology variations and operating procedures used to mine other deposits and compares these with South Texas operations. Suggestions are made as to how improvements in technology and operating procedures will make uranium in-situ mining operations more competitive in today's market.

1.0 INTRODUCTION

On September 26, 1985, the United States Department of Energy (DOE) declared the domestic United States uranium production industry as "non-viable" for the year 1984. Several factors led to this state of affairs including the imbalance of supply and demand, foreign competition, and the high cost of production of the United States' uranium resources by conventional means.

Because of the continued low price of yellowcake, it is likely that, in the future, the United States' uranium mining industry will be composed of companies developing high grade uranium resources using conventional technology and companies producing low-grade resources by in-situ or solution mining methods. In-situ mining offers the potential to expand the United States' resource base by using advanced technology to improve productivity rates and lower production costs. Table 1 and Table 2 illustrate the continued interest in this technique and the decline of open pit mining during this decade.

A considerable background of information has been built up over the last ten to fifteen years on uranium in-situ leach technology. The technique

TABLE 1
U.S. URANIUM SUPPLIERS WITH CONTRACT COMMITMENTS*

<u>Current-1987</u>	<u>Peak-1981</u>
1. Atlas Minerals (UG)	1. Kerr-McGee (UG)
2. Chevron Resources (UG)	2. Tennessee Valley Authority (OP)
3. Energy Fuels (UG)	3. International Minerals and Chemical (BP)
4. Everest Minerals (ISL)	4. Exxon Minerals (OP)
5. Freeport MoRan (BP)	5. Homestake Mining (UG)
6. Homestake Mining (UG)	6. Wyoming Mineral (ISL)
7. Intercontinental Energy (ISL)	7. Cotter Corporation (UG)
8. International Minerals (BP)	8. Western Nuclear (OP/UG)
9. Malapai Resources (ISL)	9. Federal Resources (OP)
10. Quivera (Kerr-McGee)(UG)	10. Rocky Mountain Energy (OP)
11. Pathfinder/Cogema (OP)	11. Freeport Uranium (BP)
12. UMETCO (Union Carbide)(OP/UG)	12. Pathfinder Mines (OP)
13. Uranium Resources (ISL)	13. Mobil Oil (ISL)
14. Rio Algom (UG)	14. United Nuclear (UG)
	15. American Nuclear (OP)
	16. Anaconda Copper (OP)
	17. Minerals Exploration (OP)
	18. Energy Fuels Nuclear (UG)
	19. Pioneer Nuclear (UG)
	20. Phillips Uranium (UG)
	21. Chevron Resources (OP)
	22. Gardiner (BP)
	23. Union Carbide (OP/UG)
	24. Plateau Resources (UG)
	25. U.S. Steel (ISL)
	26. Getty Oil (OP)
	27. Everest Minerals (ISL)
	28. Ranchers Exploration (UG)
	29. Atlas (UG)
	30. Gulf Mineral Resources (UG)
	31. Ogle Petroleum/Western Fuel (ISL)
	32. Rio Algom (UG)
	33. Caithress (ISL)
	34. Reserve/Sohio (UG)
	35. Intercontinental Energy (ISL)
	36. Dawn Mining (OP)
	37. Solution Engineering (ISL)

* Courtesy Malapai Resources Company

Legend:

- OP - Open Pit
- UG - Underground
- ISL - In Situ Leach
- BP - By Product

TABLE 2
ISL COMPANIES WITH
COMMERCIAL LICENSES

-
1. Intercontinental Energy
 2. Malapai Resources
 3. Everest Minerals
 4. Uranium Resources
 5. TVA
 6. CEGB (England)
 7. Uranerz (Germany)
 8. Minatome (France)
-

has been applied commercially in South Texas and Wyoming. Research and development facilities have been built and operated in deposits in Wyoming, Colorado, New Mexico, and Nebraska. This extensive field work has shown the technology can be successfully applied over a wide range of United States resources. To be sure, the methods of applying the technology need to be varied from site to site. Some sites have deep ore requiring wider well spacings, higher quality well completion materials, and innovative methods of adding the needed oxidant. Some sites have metals associated with the uranium which can potentially contaminate the yellowcake product or cause ground water restoration problems. These deposits require changes in plant design. Other uranium deposits occur in formations with very low permeability. These projects require a totally different strategy in mine planning to make them cost-effective. Winter operations require more buildings and improved wellhead designs, and mining in remote locations is best performed by using unmanned "satellite" extraction plants.

The level of confidence in uranium in-situ technology is much greater than it was ten years ago. Federal and state regulators believe the environmental impact of the technology has been adequately defined and ground water restoration technology following mining operations has been proven. In some cases, the regulators will issue commercial mining permits without the performance of the field R&D test which was required some years ago.

This paper reviews some of the variations in technologies associated with uranium in-situ mining in the different mining districts of the United States. Technical aspects affecting overall product cost are identified

and suggestions are made as to how productivity can be increased to meet today's market conditions.

2.0 TECHNICAL REQUIREMENTS FOR IN-SITU LEACHING

At the current level of technology development, there are several factors which make a site amenable to mining by in-situ techniques and some fatal-flaw factors which prevent it. The deposit must be permeable and in an existing water table with confining layers above and below the mined aquifer. Potentially fatal-flaw factors include the presence of high concentrations of humates or organic reductants, encapsulation of the uranium in clays, or uranium mineralization which is not amenable to leaching by the mildly alkaline solutions which, of necessity, are used for uranium extraction. Table 3 presents a list of the factors which determine the suitability of a deposit for in-situ mining methods.

TABLE 3
FACTORS WHICH DETERMINE THE SUITABILITY
OF A
URANIUM DEPOSIT FOR SOLUTION MINING

<u>Musts</u>	<u>Wants</u>	<u>Potential Fatal Flaws</u>
1. Artesian mineralized aquifer	1. High Permeability	1. Presence of humates or organics
2. Continuous confining layers	2. Thick ore filling the mineralized sand interval or low vertical permeability	2. Uranium encapsulation in clays or silts
3. Leachable mineral	3. Depths from 200 feet to 600 feet.	3. High molybdenum or vanadium concentrations
4. Effective contact between the leach solution and the mineral	4. Widths not less than 100 feet	4. Thin, sinuous, and deep mineralization
	5. No by-product metals	5. Poor vertical solution confinement
		6. Highly faulted formation

Assuming no fatal flaw conditions exist, a development program can be undertaken to bring the property into production. From a technical standpoint, the program would involve a) drilling and mapping the mineralization, b) sampling and testing the leachability of the ore, c) determining the reservoir factors, including porosity, permeability, ground water quality, and geochemistry, and d) estimating the rate and amount of uranium productivity the project will deliver. This technical information is used for the plant design, mine planning strategies, environmental control, and ground water restoration procedures which are part of the overall property

development plan. When the project is finally permitted and operating, it will have a network of wells in a wellfield pumping uranium-bearing solutions to a surface extraction plant. In the plant, the uranium is extracted in a simple circuit using ion exchange resin to extract the uranium from the wellfield solutions and a stripping and precipitation circuit to recover the uranium as a yellowcake product.

3.0 TECHNOLOGY VARIATIONS

Table 4 shows the general characteristics of in-situ mining projects in various regions of the United States. As might be expected, because of its early commercial history, the South Texas deposits are relatively easy to mine, having all the "must have" and most of the "want" criteria associated with solutions mining technology, referenced in Table 3. Technical variations used in other regional deposits have been developed from this base case.

Wellfield Planning - In any deposit, by far the most important technical consideration which affects economic viability is the wellfield planning. The concept is to mine only the ore and to avoid dilution of the wellfield solutions with ground water in non-mineralized areas. For in-situ mining, this is accomplished by measuring the hydrology characteristics of the aquifer, including the direction of major and minor transmissivity, and planning a pattern of wells on the surface which will allow the injected solutions access only to the ore.

Different types of ore will require different wellfield designs. In South Texas, where the ore is generally wide and thick and fills most of the host sandstone unit, the procedure has been to lay a network of wells in continuous five-spots over the mineralization. Figure 1 presents a schematic diagram of this technique.

Some Wyoming ore is high grade, thin, and sinuous, with very low injection and recovery rates per well. While these factors make the ore difficult to mine by in-situ methods, they are not fatal flaws. The problem of contact can be overcome by using a staggered line drive well layout with dimensional spacing designed to reach the outer limits of the ore through the flare of injected solutions. Figure 2 presents a schematic diagram of this concept. By using the selective well layout approach and taking advantage of the horizontal flare factor, the number of wells required to mine the

TABLE 4
CHARACTERISTICS OF U.S. IN-SITU LEACH DEPOSITS

<u>State</u>	<u>Resources, lbs</u>	<u>Depth Range, ft</u>	<u>Characteristics</u>	<u>Special Problems</u>
South Texas	1985; 20.2 million 1986; 19.3 million	200-800	<ul style="list-style-type: none"> o High Permeability o Thicker ore intercepts o Clean sands 	<ul style="list-style-type: none"> o Low levels of Mo in some ores o Faulting o Saline water in some areas
Wyoming and Nebraska	1985; 146.6 million 1986; 234.4 million	200-1,000	<ul style="list-style-type: none"> o Lower permeability o Thin, high grade ore intercepts o Good ground water quality 	<ul style="list-style-type: none"> o Varying levels of vanadium o Insufficient ground water levels in some cases o Winterization required, and remote locations
New Mexico	1985; 72.5 million	800-2,500	<ul style="list-style-type: none"> o Intermediate to high permeability o Very thick host sand (100 ft. plus) o Multiple mineralized intervals in one sand 	<ul style="list-style-type: none"> o Deep ore o High Mo concentrations in some areas o High humate concentrations in some areas

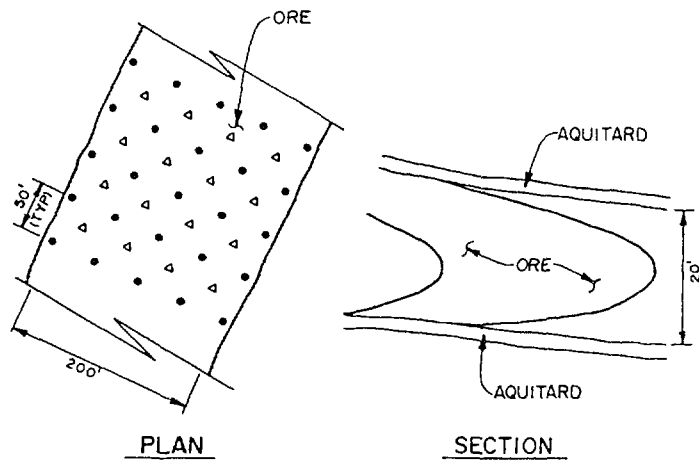

LEGEND:

- INJECTION WELLS
- ▲ PRODUCTION WELLS

FIGURE 1
THICK ORE MINED
BY REGULAR 5-SPOT PATTERNS

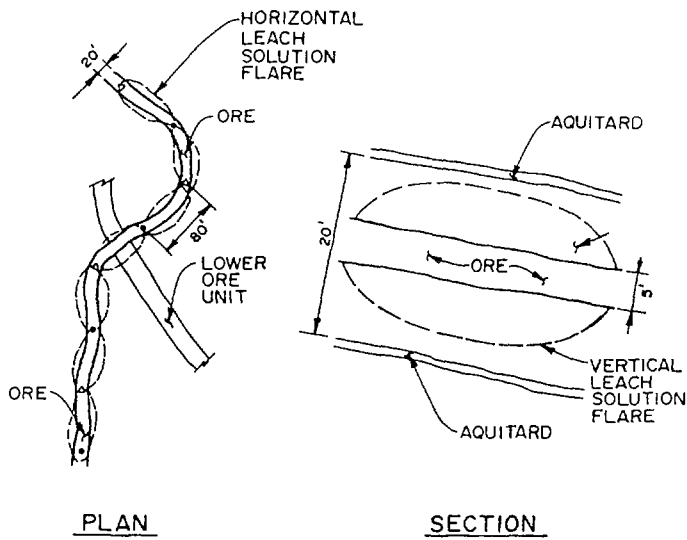

LEGEND:

- INJECTION WELLS
- ▲ PRODUCTION WELLS

FIGURE 2
THIN, SINUOUS ORE MINED
BY A LINE DRIVE ARRANGEMENT

ore can be reduced by 33 percent and the uranium concentrations in the wellfield solutions can be increased by 230 percent over what would be achieved by laying five-spots over the ore. Both of these factors, but particularly the reduction in the number of wells needed, have a significant effect in reducing uranium production costs.

In the extreme case, the upper limit of mineability of thin ore in a thick sand unit can be the vertical flare of injected solutions into barren areas above and below the mineralized zone.

In areas of low flow, less wells means less flow to the plant, which has a negative impact on uranium product cost. This problem can be overcome by mining a larger area at one time, which has the effect of moving the wellfield replacement costs toward the front end of the project. These negative cost effects, however, are heavily outweighed by the positive when this mining strategy is adopted for narrow sinuous roll fronts.

Mining Multiple Intercepts - When ore intercepts overlay each other, as shown on Figure 3, a strategic decision has to be made whether one ore intercept is to be mined at a time or all intercepts will be mined at the same time. In some cases (Figure 4), the ore can occur in separate sand-

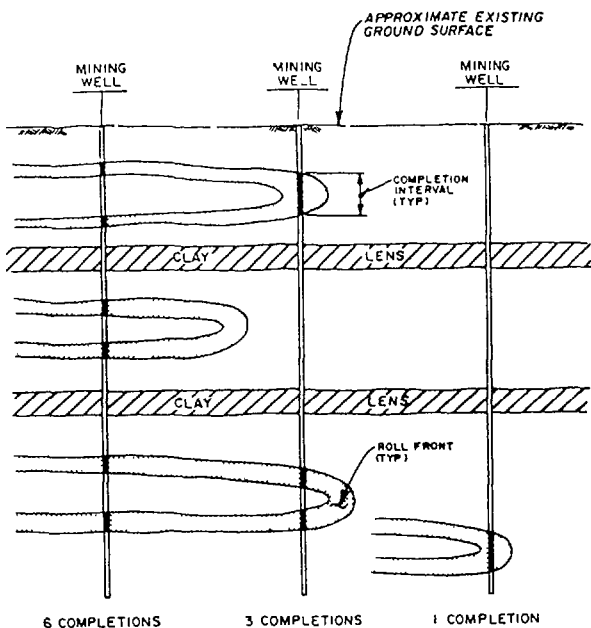

FIGURE 3
SCHEMATIC REPRESENTATION
OF MULTI-ZONE MINING

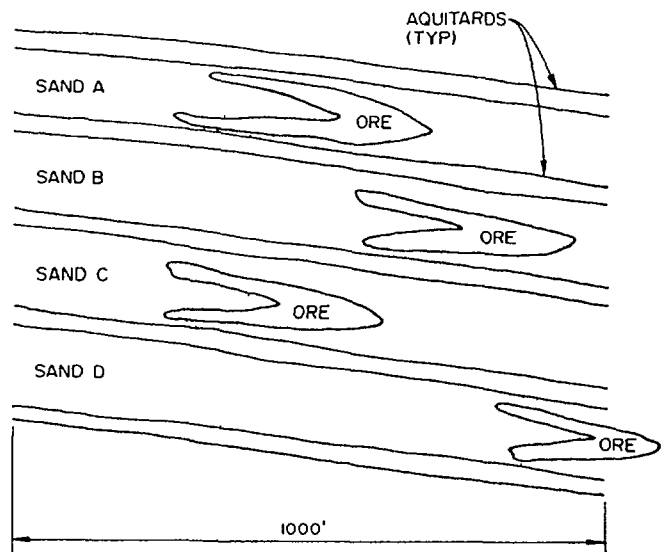

FIGURE 4
STACKED ROLL FRONTS
SET WITH INTERVENING
AQUITARDS

stone units separated by impermeable barriers or aquitards. Some deposits have from six to eight of these stacked roll fronts which might be intercepted by one well.

The percentage of the deposit which has multiple completion generally has an affect on the concentration of uranium in the wellfield solutions, as shown in Table 5. If the overall permeability is high, such as in some South Texas and New Mexico deposits, the problem will be less severe since the intercepts can be mined simultaneously with reasonable assurance that all zones are being swept by the leach solution. If the permeability is low and variable, however, mine plans will have to be adjusted to mine specific intercepts which contain the best ore. In this case, the overall reserve will be reduced, but product costs can be expected to decrease. Some deposits in Wyoming have these characteristics.

TABLE 5
EFFECT OF SINGLE AND MULTIPLE ZONES MINING ON
URANIUM CONCENTRATIONS IN THE WELLFIELD SOLUTION

<u>LOCATION</u>	<u>NUMBER OF ZONES</u>	<u>U₃O₈ PPM⁽¹⁾</u>
Area 1	1	84
Area 2	1	86
Area 3	up to 5	48
Area 4	up to 5	42

(1) Average U₃O₈ ppm in the wellfield solution at 70 percent extraction.

Leach Chemistry and Geochemistry - In the early years, several attempts were made to leach in-situ with strong acid or basic solutions which are successfully used in conventional milling circuits. These approaches were abandoned because of the massive alteration of the existing geochemical equilibrium which either plugged the formation or made it impossible to restore the ground water to an acceptable quality approximating baseline conditions. In all cases, a low strength solution of bicarbonate and oxygen is now used. The oxygen is provided by dissolving oxygen gas in the ground water, either in a surface saturator or in each individual well.

The oxidation reactions are:

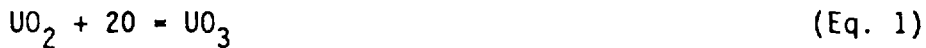

The oxidized uranium is leached by the ground water which typically contains between 700 to 1,500 parts per million of bicarbonate ion:

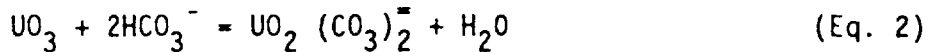

In the early days of the technology, the bicarbonate ion was added as ammonium bicarbonate. Operating problems and environmental considerations dictated a change to either sodium bicarbonate or dissolved carbon dioxide gas. Both of these lixivants are used today. In general, the solution is kept around pH of 6.8 to 7.0 to maintain a high solubility of calcium which can foul the surface lines and the injection wells.

The geochemistry of deposits vary in the different regions. Some South Texas deposits have significant pyrite mineralization which causes a buildup of sulfate ions. In extreme cases, gypsum saturation occurs and plates out on the inside of surface lines carrying the wellfield solution to the plant. If sulfate builds up faster than the uranium is being mined, the resin loading drops off and the stripping rate has to be increased. This results in a significant lowering of plant throughput capacity and more frequent hauling of loaded resin from remote satellite plants. One plant in South Texas has experienced resin capacity declines of between 75 percent and 80 percent due to sulfate buildup. The problem has been addressed by maintaining separate ion exchange trains to process "new" and "old" wellfield solutions. Another method to address this problem is the installation of an auxiliary process (Figure 5) which simultaneously controls sulfate or total dissolved solids (TDS) buildup and adds bicarbonate (lixiviant) to the wellfield solution.

In contrast to South Texas, in-situ mining environments in Wyoming and New Mexico are relatively free from sulfur and, in some cases, high uranium resin loadings can be obtained. Some deposits in New Mexico, however, have high molybdenum concentrations which severely limit the ability of the ion exchange resin to extract uranium. In this case, radical changes in plant and process design are required to obtain acceptable extractions of uranium and to produce a yellowcake product of acceptable quality. The Mobil Oil

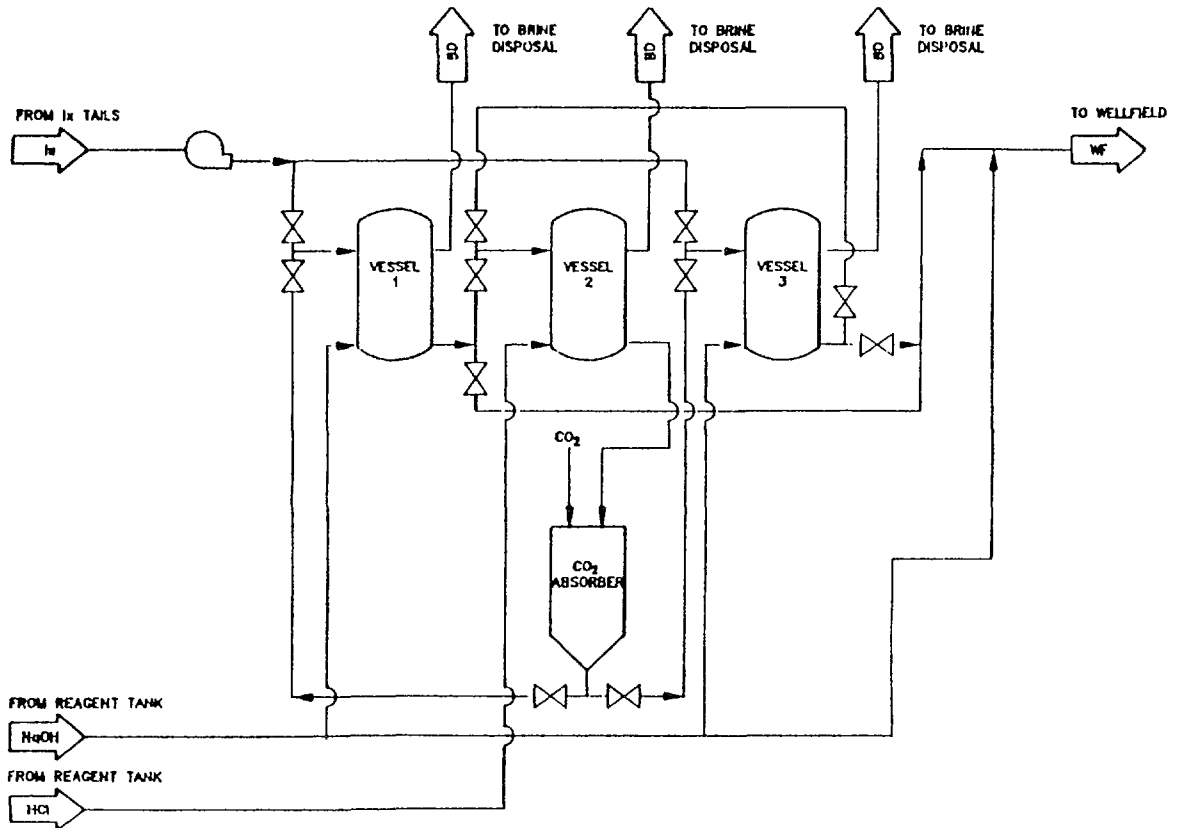

FIGURE 5

SULFATE CONTROL PROCESS

plant at Crownpoint, New Mexico, has an innovative primary ion exchange design and a new uranium/molybdenum separation circuit to overcome these problems.

One final aspect of leach chemistry is permeability enhancement. Much of the development work done on leach chemistry to date has been to improve operating procedures and tailor leach compositions to minimize or avoid the degradation of existing reservoir conditions. In very tight formations, permeability might actually be improved by injecting cations which will react and shrink the clay fractions of the formations. Improved permeability is expected to enhance leaching and ground water restoration rates by improving the ability to inject and recover solutions from the ore. This technology will be applicable to some Wyoming deposits, but may have limited value in the more permeable South Texas deposits.

By-Product Production - The by-product metals, vanadium and molybdenum, frequently occur with the uranium mineralization. Wyoming deposits typically have vanadium but no molybdenum. Molybdenum occurs with uranium in South Texas and New Mexico deposits.

None of the commercial facilities have produced a saleable metal by-product. The amounts of the metals which are mobilized are generally only enough to cause product purity problems. They are separated out by modifying the processing circuits and discharged as waste streams. Figure 6 is a schematic diagram of a molybdenum control circuit which has been used in one South Texas plant.

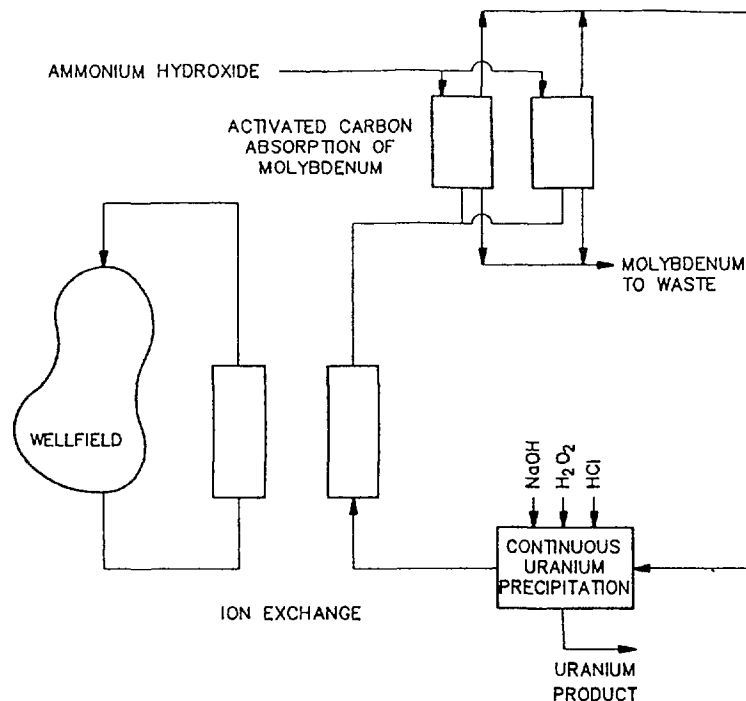
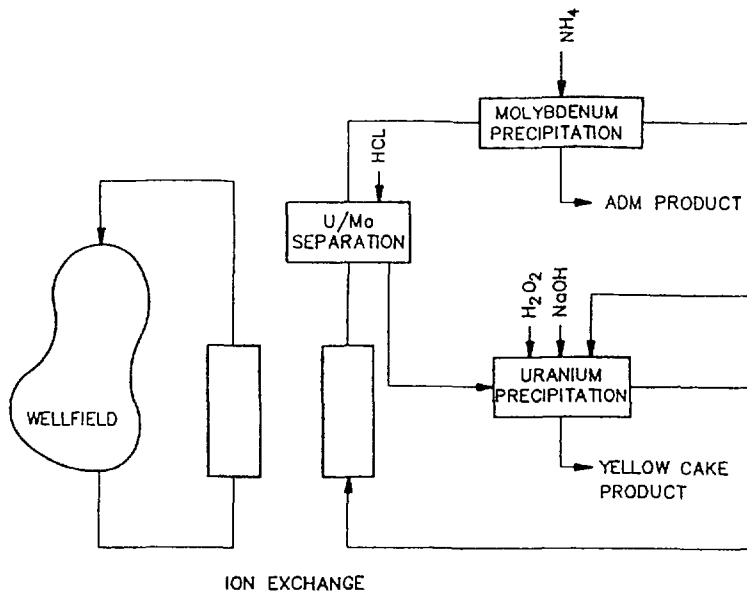

FIGURE 6
MOLYBDENUM REMOVAL CIRCUIT
-USED IN COMMERCIAL PLANTS

It is expected that future plants will produce by-product metal values where these metals are mobilized with uranium in significant concentrations. The by-product circuits will likely be used in New Mexico and Wyoming where molybdenum and vanadium concentrations, respectively, can be very high. Schematic details of the process steps involved are illustrated for molybdenum on Figure 7 and for vanadium on Figure 8.

Ground Water Restoration and Waste Disposal

Reverse osmosis (RO) is the commonly accepted method of restoring the quality of the ground water to baseline conditions following mining operations. In many cases, commitment to this technique is required by the



ION EXCHANGE

FIGURE 7

MOLYBDENUM
BY-PRODUCT CIRCUIT

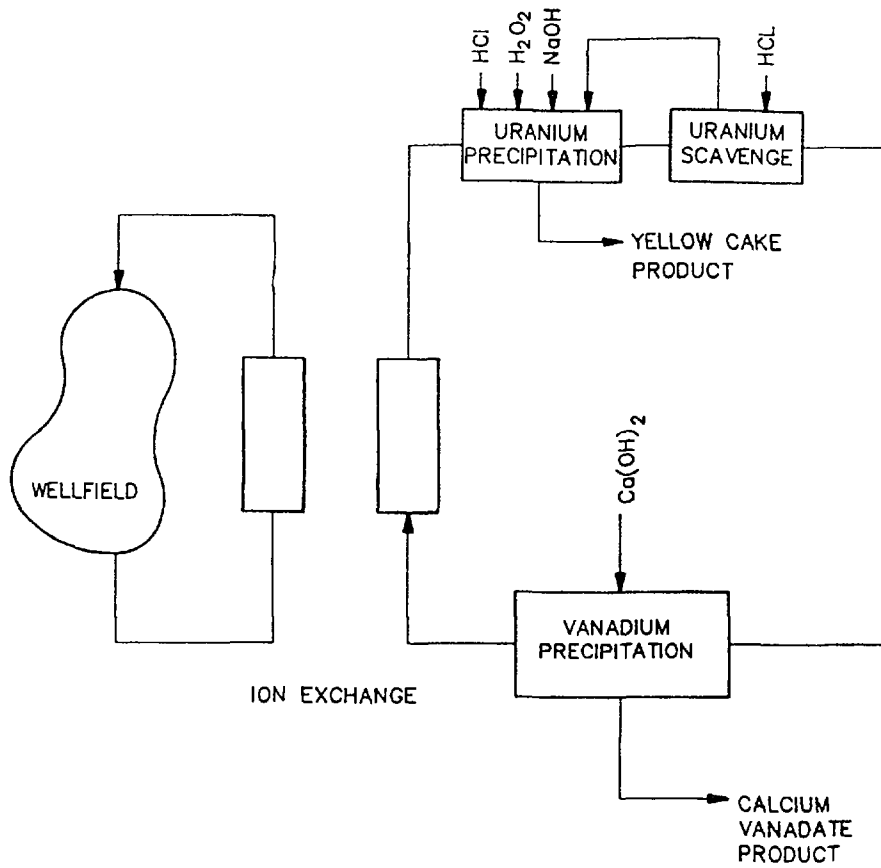

ION EXCHANGE

FIGURE 8

VANADIUM
BY-PRODUCT CIRCUIT

regulatory agencies prior to issuing a mining permit or a source material license. Figure 9 shows a schematic diagram of the process. The wellfield solution is fed into the RO, the dissolved salts are concentrated into a brine, and a clean product water is produced. The relative amounts of brine and product water depend on the concentrations and nature of the salts in the wellfield solution. The brine is a waste product which is stored and evaporated or disposed of in a deep well. The product water can be surface discharged or re-injected back into the wellfield to accelerate ground water restoration.

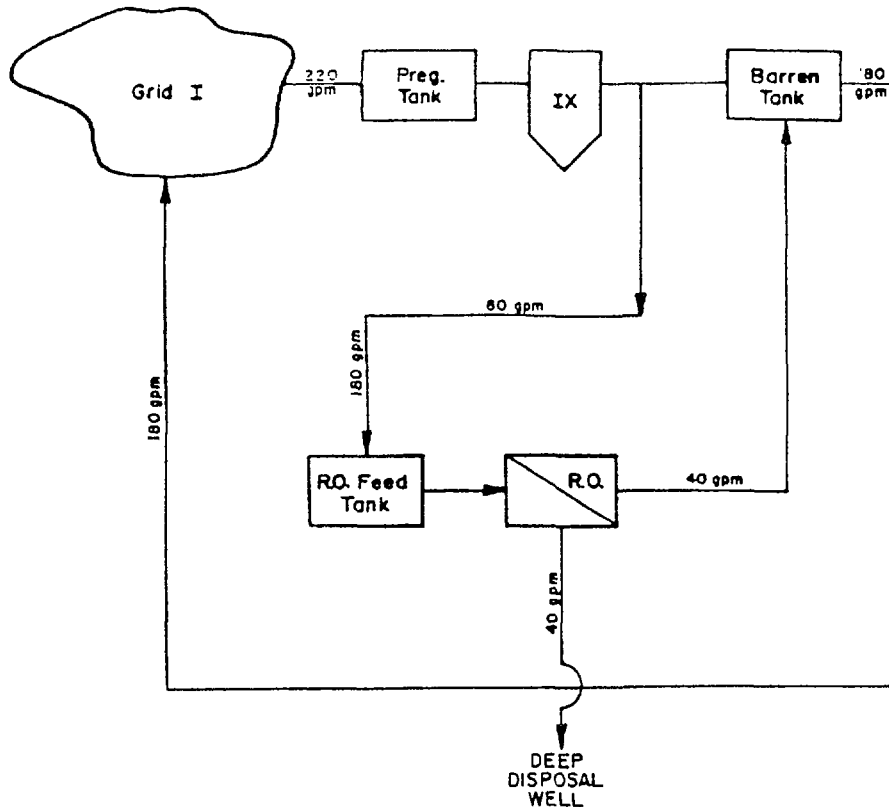

FIGURE 9

RESTORATION PROCEDURE
(MODIFIED REVERSE OSMOSIS)

The differences in ground water restoration among mining regions relates more to the background water quality and the regulatory requirements rather than to the process used. In some cases in South Texas, the overall water quality is poorer than in Wyoming and New Mexico. Consequently, it is easier to reach baseline conditions. In addition, the regulatory requirements for long-term stabilization are less stringent in South Texas than in these other states. Overall water use by the restoration process is not as major a concern as it is in the more arid areas.

In-situ mining projects in Texas and Wyoming use the same type of restoration equipment. The differences between these regions relate to the composition of the ground water at the start of restoration and the local regulatory constraints for final ground water quality and waste disposal procedures. Components in the ground water following leaching, such as calcium, barium, strontium, carbonate, sulfate, and silica and residual uranium, cause membrane fouling problems which increase the amount of brine for waste disposal. The problem can be reduced by using ground water sweep with treatment and surface discharge, but this technique wastes large volumes of water.

In South Texas, which has high TDS water but no water shortage, ground water sweep has been used coupled with deep well disposal and/or surface irrigation. An RO polish may be used at the end of this initial step to bring the overall water quality to acceptable levels.

Wyoming and New Mexico have generally better ground water quality and arid conditions. In these areas, ground water restoration has been performed by RO with re-injection of the permeate into the aquifer and evaporation of the brine in ponds.

4.0 WAYS TO MAKE IN-SITU MINING COMPETITIVE

The previous technical considerations demonstrate how technology variations can extend the amount of United States uranium resources which are recoverable by in-situ mining methods. The question remains whether these resources are competitive in today's world markets and how their competitive position can be improved.

There are two types of players in the uranium supply side of the energy equation, those being United States producers competing for sales on domestic and foreign markets and foreign interests seeking primarily to acquire and perhaps develop resources for home consumption. Referring to Figure 10, about 33 percent of the 1987 potential producers in the United States are foreign holdings.

The attractiveness of United States-based resources for foreign countries is a) political stability, b) minimal government constraints on export, c) no government requirements for part domestic ownership, and d) no produc-

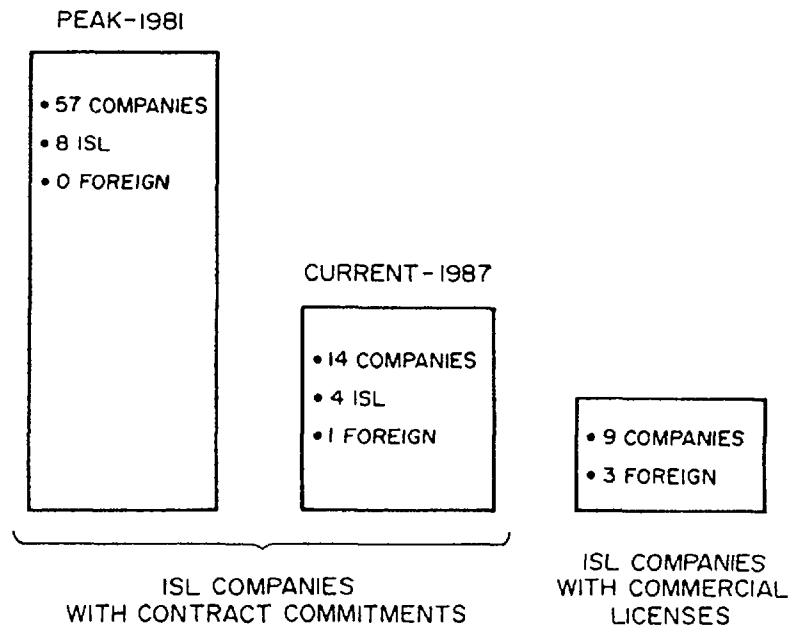

FIGURE 10
U.S. URANIUM PRODUCERS

tion commitments. These factors, combined with low acquisition costs, make the United States' uranium resources an attractive acquisition. In some cases projects can be acquired which come complete with commercial operating permits. If the properties are in-situ mineable, uranium production can be "turned on" in a relatively short time, from 12 months to 18 months, at minimum up-front capital expenditures and low technical risk.

To be sure, legislative corrections have been introduced which affect the development of United States uranium resources. On the one hand, recent court actions and the Domenici Bill seek to constrain uranium imports to the United States until domestic producers become viable, while, on the other hand, the recently proposed Free Trade Agreement with Canada brings the richer Canadian resources into direct competition with United States producers.

These legislative swings do not reduce the fundamental attractiveness to foreign investors of United States resources, but may affect the time frame in which they are developed. In the meantime it is incumbent upon the existing producers to use technical innovations and development procedures which will enable them to stay competitive in today's marketplace.

Operating Improvements

There are several operating improvements which will reduce the cost of producing uranium by in-situ methods. Table 6 shows that the "big ticket" items in the product cost list are labor, well replacement, and ground water restoration.

TABLE 6
TYPICAL ISL DIRECT OPERATING COST BREAKDOWN

<u>ITEM</u>	<u>PERCENT OF TOTAL</u>
Wellfield Replacement*	27.0%
Chemicals	13.0%
Power	2.5%
Payroll*	17.0%
Maintenance	2.5%
Reclamation and Restoration*	17.0%
Royalties and Taxes	14.0%
Other	7.0%

*Major cost centers.

Labor costs can be significantly reduced by operating unmanned satellite mining stations much in the same way as stripper pumps work on oil reservoirs. In this case, the resin is trucked to a central processing facility for uranium recovery. The satellite concept allows large areas of uranium reserves to be mined by a small number of people. Leach chemistry, well completion, and reservoir management technology exist today to be able to operate these satellites unmanned or with a minimum of manpower.

As pointed out earlier, well replacement costs can be significantly reduced by using intelligent mine planning methods. The technologies have reached the level of sophistication where very accurate predictions of uranium concentrations in wellfield solutions can be made. Figure 11 shows a recent illustration of this point in a Wyoming project.

Complete ground water restoration is achievable by other technical methods which are more cost effective than RO. Proven chemical methods can reduce

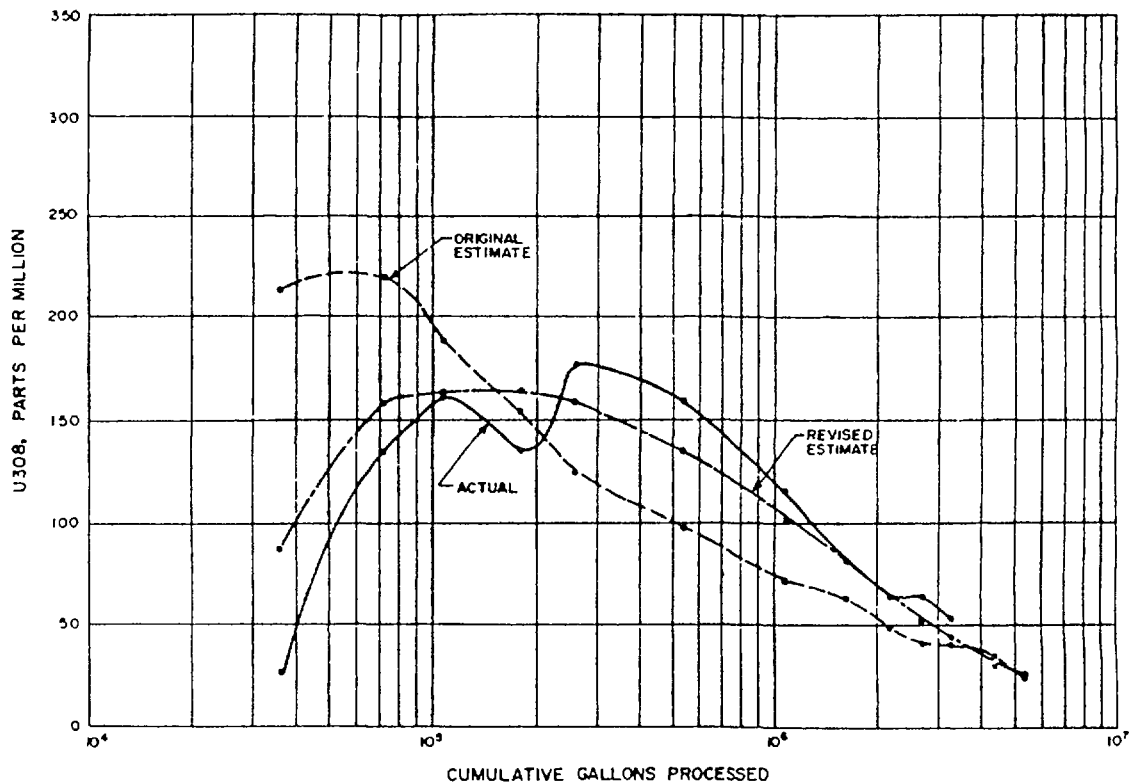

FIGURE II
COMPARISON OF CALCULATED
AND ACTUAL
SOLUTION GRADE

the cost of ground water restoration by as much as 94 percent or produce 95 percent less waste for surface disposal. Table 7 compares alternative ground water restoration methods.

These and other technological improvements have the potential to make uranium in-situ mining cost competitive in today's market for a wide range of United States resources.

5.0 CONTRACT DEVELOPMENT

Because of the high-tech nature of uranium in-situ mining operations, the percentage of the total headcount which falls into the technical, and management categories is much higher than for conventional mining operations. Table 8 presents a breakdown of requirements for a typical in-situ mining project.

TABLE 7

COMPARISON OF GROUND WATER RESTORATION ALTERNATIVES FOR A WELLFIELD

Restoration Method	Estimated Cost \$/lb. U ₀ 3 8	Waste Amounts *			Advantages	Disadvantages
		Type 1 MM. Gals.	Type 2 MM. Gals.	Type 3 ** Tons		
Reverse Osmosis	\$3.75	None	30	2,402	Technology proven and accepted by agencies.	High cost. Solid waste produced if no deep well.
Ground Water Sweep Plus RO	0.96	144	5	1,705	Low cost. Simple plant operation.	High water consumption.
Ground Water Sweep Plus Chem. Restn.	0.23	144	None	2,125	Low residual U, V, Ra, trace metals. Low cost.	High water consumption. Bench test results only, no field experience. Not effective on Cl, SO ₄ .
Chem. Restn. Plus RO	1.41	None	12	1,406	Low residual U, V, Ra, trace metals. Used successfully in S. Texas. Low water consumption.	Works better on low Na leach, high baseline TDS groundwater.
Cation Resin Plus Chem. Restoration	1.67	None	10	108	Low residual U, V, Ra, trace metals. Used successfully in Wyoming and S. Texas. Low water consumption.	More complicated plant opns.

* Restoration Volume 180 MM Gallons
 Type 1 is Surface Discharge Waste
 Type 2 is Poned Brine Waste
 Type 3 is Solid Waste

** Solid wastes require disposal in low level rad. waste site.

TABLE 8
FUNCTIONAL BREAKDOWN OF AN ISL OPERATION

<u>FUNCTION</u>	<u>HEADCOUNT</u>
PROVIDED BY OWNER:	
Management	2
Administration	5
Environmental and Safety	2
Analytical	3
Maintenance	3
Operators	<u>16</u>
Subtotal	31
PROVIDED BY CONTRACTOR:	
Permitting	2
Construction	5
Technical	<u>12</u>
Subtotal	19
TOTAL HEADCOUNT:	<u>50</u>

If the wellfields and plant designs are done properly, the operation of central and satellite plants can be performed with very low manpower requirements yielding productivities on the order of 30,000 pounds to 50,000 pounds of uranium per man-year. Once the plant is built and operating, the ongoing technical activities are related to production planning to meet financial goals, and ground water restoration planning to meet regulatory requirements. These activities include development drilling to establish reserves, generation and comparisons of wellfield designs which will meet a range of financial and productivity criteria, design and construction of new wellfields and satellite plants, and restoration of the ground water in old wellfields.

Because of the variations in technology required for different sites, which we have just reviewed, a technical organization needs to be formed which will be a repository of knowledge and know-how. This organization provides the technical planning and quality assurance/quality control (QA/QC) needed to obtain the lowest possible product cost from uranium in-situ mining projects.

Another area of concern is construction. For wellfield installation, an operating company will typically hire a contract driller, usually by com-

petitive bid, to install the wells supervised by a company geologist. One of several well completion techniques may be appropriate for the deposit, but perhaps the geologist and certainly the driller will not be familiar with the selected well completion method. This lack of continuity of experience results in decreased QA/QC control on the wellfield installation, which can have significant adverse impact on uranium product cost.

In the past, companies engaged in conventional mining have typically provided internal management and technical assistance to operations. A very good reason for this has been to maintain a competitive edge over other producers, whereby product costs can be reduced through technical innovation and improved operating procedures. Because of the "high-tech" nature of in-situ mining, a large proportion of the labor budget is taken by technical services. In addition, there is a shortage of qualified personnel with the needed skills. For these reasons, it is likely the use of specialized contract technical and construction services on an interim basis will have a greater impact on reducing the project's bottom line than will internal technical and cost control programs. This concept is especially appropriate for foreign countries investing in United States markets where the primary goal is the acquisition of uranium supplies for home consumption, but there is an ongoing need to pursue property acquisition, permitting, and property evaluation activities independent of project development and production.

Figure 12 presents a suggested functional organization chart. In this case, the contract development organization provides the permitting and technical direction for new ventures on an as-needed basis. The owner

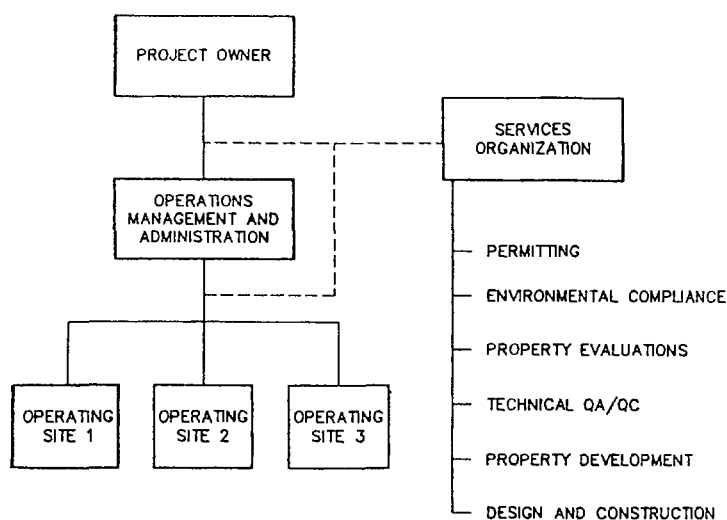

FIGURE 12
CONTRACT SERVICES
ORGANIZATION

manages and operates the projects although these services can also be contracted out to an independent group with operating skills.

6.0 CONCLUDING REMARKS AND ACKNOWLEDGMENTS

It is likely the domestic United States' uranium industry will continue to produce at a much lower annual production capacity than was achieved in the late 70's and early 80's. If the production levels out at 13 million to 15 million pounds per year, about three million to five million pounds of this amount can be expected to come from in-situ leaching projects located in the regions presented in this paper.

At this time, the United States offers an excellent opportunity for foreign governments to acquire uranium resources for future home consumption. The technology and skills exist for the development of these resources on a time frame which meets the individual needs.

I wish to personally thank Mr. Fred C. Hohne and Mr. Myron Beck of Malapai Resources Company for their support in the preparation of this paper.

Thank you for this opportunity to address the International Atomic Energy Agency.

GROUNDWATER RESTORATION AND STABILIZATION AT THE RUTH-ISL TEST SITE IN WYOMING, USA

C. SCHMIDT

Uranerzbergbau GmbH,

Bonn, Federal Republic of Germany

Abstract

The paper describes operations of restoration and stabilization of the Ruth Site in Wyoming, USA. The Ruth orebody, listed by tertiary sediments, exploitation was started in 1981 as a pilot test before construction of a commercial production facility.

The several phases of the pilot test are described:

- licensing and pre-operational base lining
- leach test
- ground water restoration and
- stabilization

Introduction

The first uranium produced in the United States by solution mining came from a small test facility in the state of Wyoming in 1963. Between 1969 and 1975 more tests were conducted in southern Texas. The first commercial facilities came on stream in Texas in 1975 (Clay West, Bruni). At that time the new technology, which first emerged as an idea in the 50s, had grown into a widely recognized and competitive method to produce uranium. After 1975 numerous operations both test facilities or commercial production plants, were started in Montana, Wyoming, Colorado and Texas, later also in Nebraska and New Mexico. Uranium production by solution mining peaked in 1981, when 2100 sht U_3O_8 or 11 % of the U.S. production came from this source.

Uranerz U.S.A. Inc., the Denver based affiliate of the German company Uranerzbergbau GmbH, is exploring for uranium in the United States since 1973. The possibility to apply solution mining or in situ leaching to

deposits in Wyoming was already investigated in 1975. Some research was done, but a suitable ore body was discovered only in 1978. The decision to conduct a pilot leach test on the Ruth orebody as first step towards commercial production was made in 1979.

The Ruth orebody is hosted by Tertiary sediments of the Powder River Basin in Wyoming. The test site is located about 105 km north of the city of Casper (Figure 1). Work on the project started in fall of 1979 with baseline data collection as part of the necessary licensing procedure.

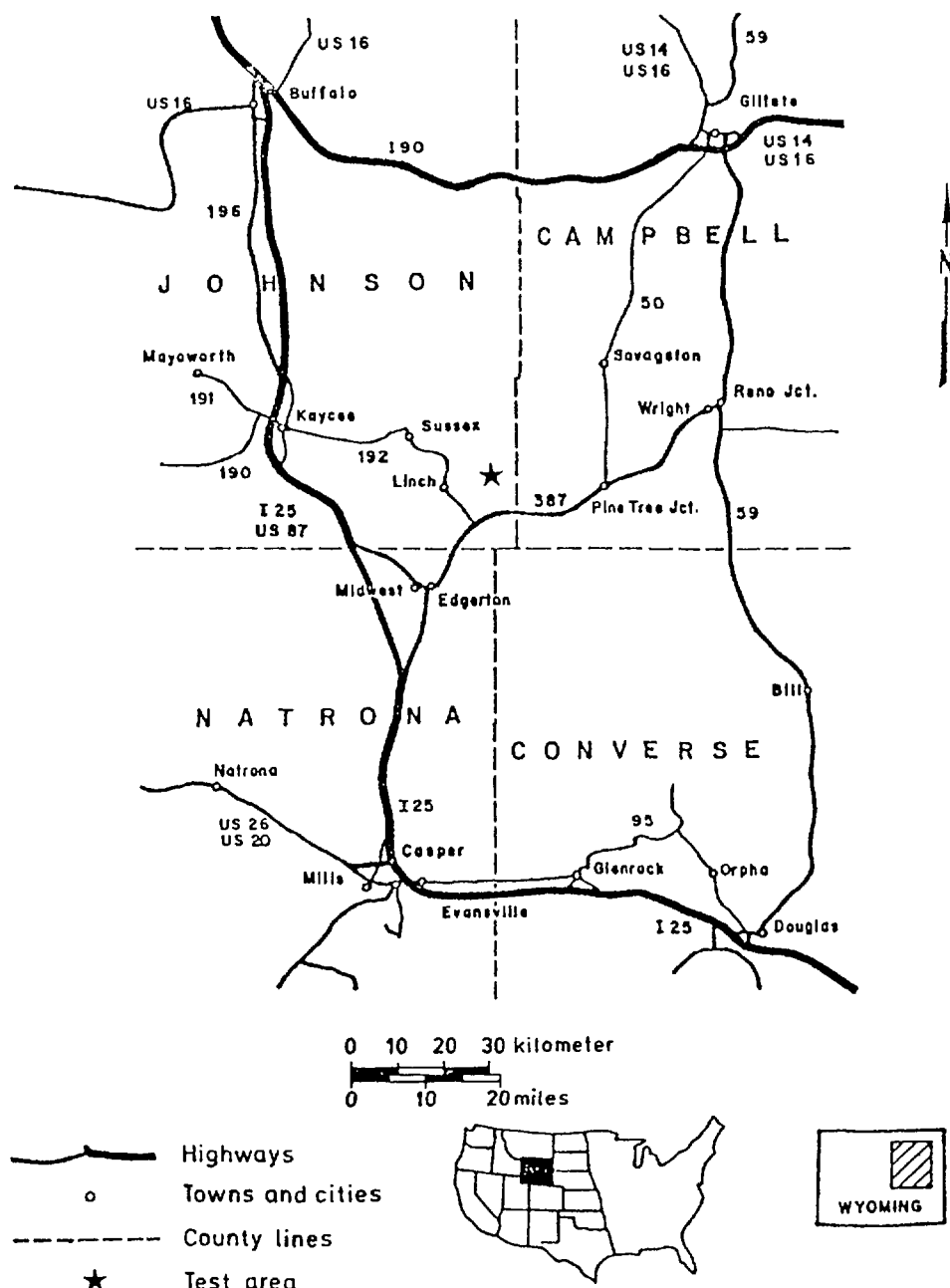

Figure 1.
Ruth- ISL
Location Map

License applications were filed in fall of 1980 and the permits were issued October 1981. The leach test and following groundwater restoration lasted from 1983 through 1984. The test was successfully concluded, when the involved regulatory agencies approved groundwater restoration after 12 months of monitoring.

The success of the test led to the acquisition of another orebody in the vicinity of Ruth. The licensing process for a commercial in situ leach facility for both orebodies started this year.

Purpose of a pilot test

A small scale leaching field test prior the construction of a commercial production facility is commonly called a pilot test, but this is not quite correct. The operational people prefer the term "research and development project", with emphasis on gathering site specific engineering information, while regulatory agencies require the test as a small scale demonstration of groundwater restoration. A pilot test serves several purposes.

In Wyoming, and in most other states where in situ leaching is applied, state and federal agencies - that are the state Department of Environmental Quality and the federal Nuclear Regulatory Commission - mandate a small scale test in order to evaluate the possible environmental impacts before permitting a large scale operation. For the agencies the demonstration of successful restoration of groundwater quality after leaching is a prerequisite for the issuance of a commercial license. If pre-operational groundwater quality can not be restored, using best practical technology, the application for a commercial license will be rejected and a license denied. Groundwater restoration is, therefore, the most crucial and most sensitive aspect of an in situ leach pilot test, at least in areas where groundwater quality is of concern.

Another purpose of a pilot test is to investigate site specific reactions of the ore body to the applied leach chemistry applied. This information is needed for the design of the commercial plant. Most of this information can only be gained through field testing, e.g. development of solution head grades over time, extraction rate, well flow rates, well spacing, changes in well efficiencies and well maintenance requirements, consumption of chemicals, leaching and suppression of elements other than uranium e.g. calcium, molybdenum, vanadium.

A third reason for a small scale test can be to demonstrate the overall viability of the new leaching method to the non-technical corporate management. Larger companies sometimes tend to be very reluctant and sceptical when it comes to apply a new and therefore not thoroughly accepted technology.

Pilot test phases

A pilot test, as the one on the Ruth orebody, is conducted in several subsequent phases of which the actual leach test is only one:

- Pre-operational baselining, as part of licensing
- Leach test
- Groundwater restoration
- Stabilization

Part of the pre-operational environmental baseline data collection is the determination of groundwater quality. This pre-operational groundwater quality defines the restoration goals or targets. The general goal is that the water use category must after restoration be equal or better than before leaching. Restoration targets are established during the licensing procedure.

During the restoration phase the operator has to bring the lixiviant concentrations and the concentrations of other elements mobilized during leaching down to restoration targets. The methods to be applied will be described later. After the operator has determined that restoration goals on all parameters are reached, the agencies take independently samples for confirmation. If results of the operator can be confirmed, the restoration is officially completed and the phase of stabilization commences.

The stabilization phase was introduced by the Wyoming Department of Environmental Quality after experience with other solution mining operations had shown that concentrations of monitored parameters increased considerably after some time and restoration had to be restarted. As reason for this behavior was determined that restoration had been achieved only in the vicinity of the sampling wells. Larger volumes of still contaminated solutions had remained between the wells. Diffusion later resulted in homogenization and increase of concentrations in the sampling wells.

Minimum duration of the stabilization phase is defined in the license as a permit condition. For pilot operations the stabilization phase was six months, but is now extended to at least 12 months. For commercial operations the DEQ required recently a stabilization phase of five years.

Regulatory agencies take again confirmation samples at the end of the stabilization phase. If the operator's values are found to be accurate, groundwater restoration can be signed off.

Description of test facility

The Ruth orebody, containing approximately 4 million lb U_3O_8 , is hosted by a sandstone unit of the Eocene Wasatch Formation of the central Powder River Basin. The basin is a Tertiary trough with its axis parallel to the Rocky Mountain front range (Figure 2). The basin is filled with 4500 m (15 000 ft) of monotonous series of sands, silts, shales from upper

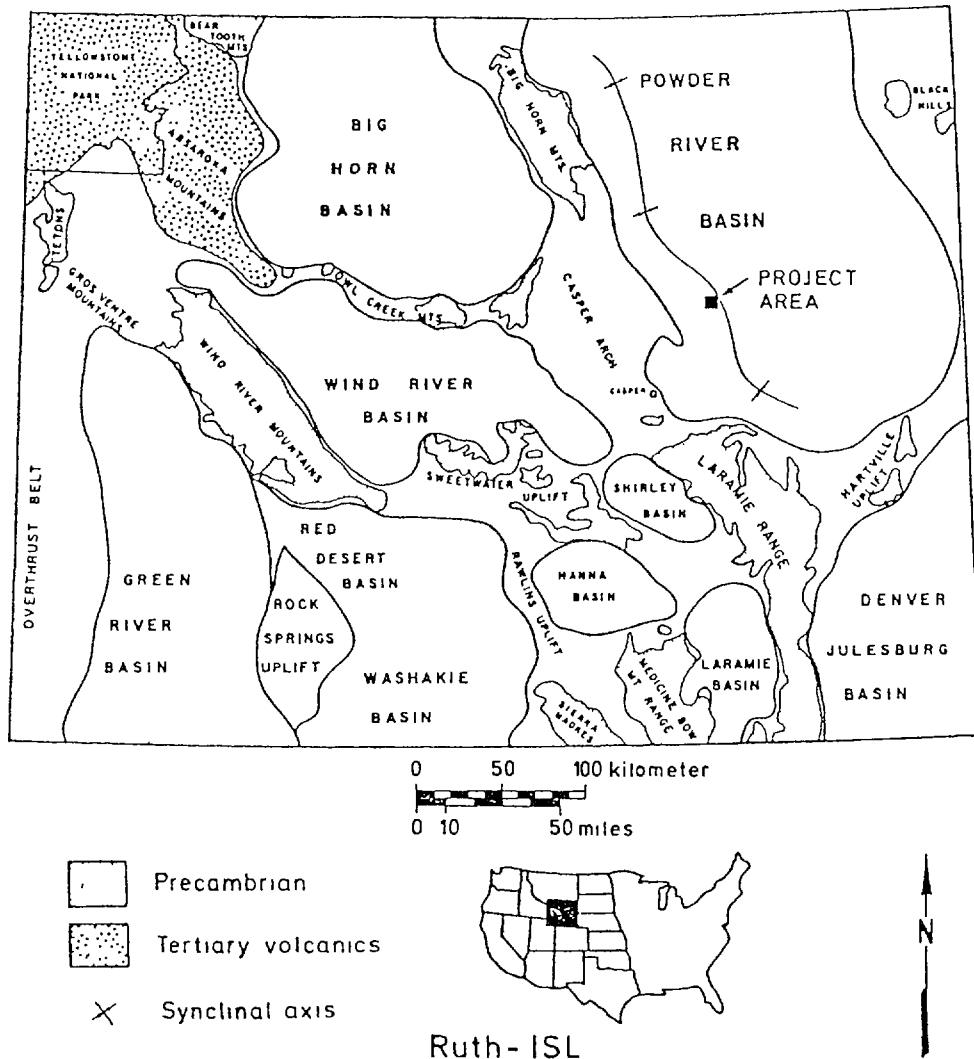

Figure 2. Structural Map of Wyoming

as used by Uranerz' field geologists. The orebody is in the 20 sand. This sandstone is an artesian aquifer with a permeability of 150-300 md. The ore mineral is mainly amorphous uranium oxide and pitchblende. Average grade in the testfield was 0.272 % U_3O_8 , average thickness was 1.20 m (3.89 ft).

The wellfield consisted of 32 leach wells and seven monitor wells. The leach wells were arranged in seven hexagonal patterns (7-spots), each pattern with a recovery well in the center and six injection wells around it (Figure 4). Well distance was 9.15 m (30ft), average well depth was 164 m (537 ft). Seven monitor wells were drilled in and around the leach wellfield. Monitor wells were sampled every two weeks during leaching to discover immediately any escape of lixiviant from the leach zone. Three infield monitors were completed in the first aquifer below and in two aquifers above the leaching zone. Four outlying monitors were drilled in about 62 m (204 ft) distance around the wellfield and completed in the ore bearing aquifer (Figure 5). All wells were completed as open holes by underreaming with 17.8 cm (7 inch) blades after cementation.

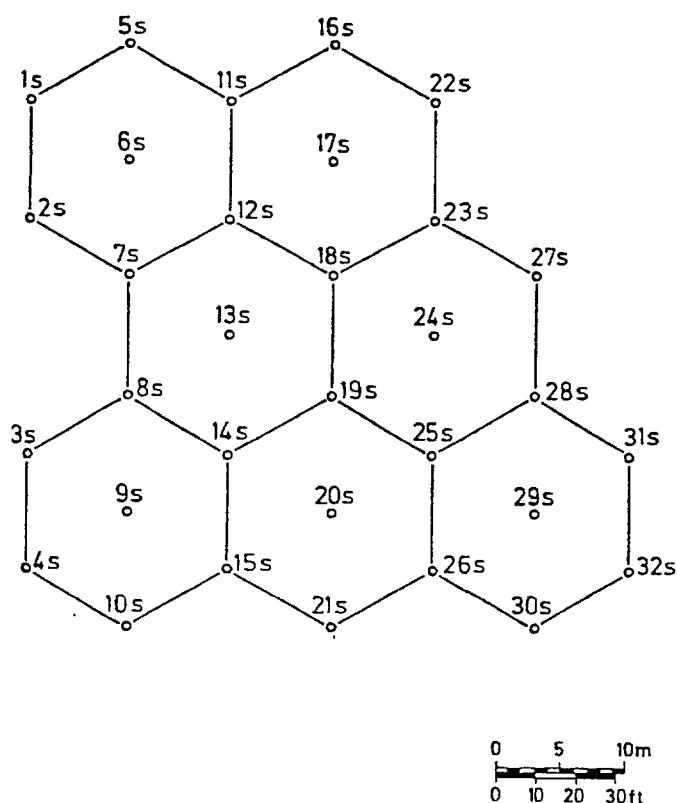

Figure 4.

Ruth-1SL
Wellfield Arrangement
 Schematic

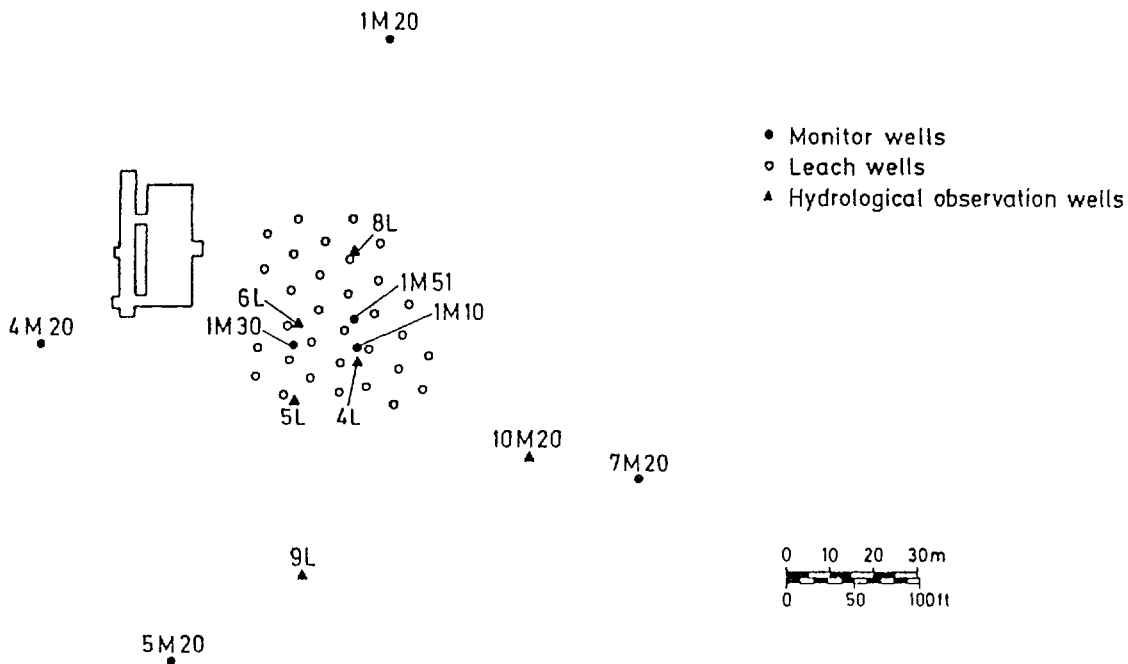

Figure 5.
Ruth-ISL
Well Locations

The monitor wells were installed prior to the drilling of the leach wellfield. They were used as sampling wells for pre-operational baselining until start up, together with some hydrological test wells.

Design capacity, that is the flow rate through plant and wellfield, was 379 l/m (100 gpm). Effective capacity over 12 months was 334 l/m (88.2 gpm) or 88 % of design capacity. Overpumping rate was average 3.3 % of injection rate or in other words: injection was 11 l/m (2.9 gpm) lower than average recovery. This was done in order to create a shallow cone of depression in the wellfield; escaping solutions are thus returned to the wellfield by a constant radial inflow of fresh groundwater towards the recovery wells (Figure 6). Leach chemistry applied was sodium bicarbonate leach at 6.5 - 7.0 pH. Maximum bicarbonate concentrations amounted to 1.8 g/l. Gaseous oxygen was used for oxidation, carbon dioxide for pH-control and clay conditioning.

Surface installations consisted of the plant building with surge tanks for injection and recovery, of three ion exchange columns, one elution column, chloride control tank, eluant make up tank, lixiviant make up tank, precipitation tank and filter system. Surplus solution from the plant and the wellfield overproduction was disposed of in two evaporation ponds.

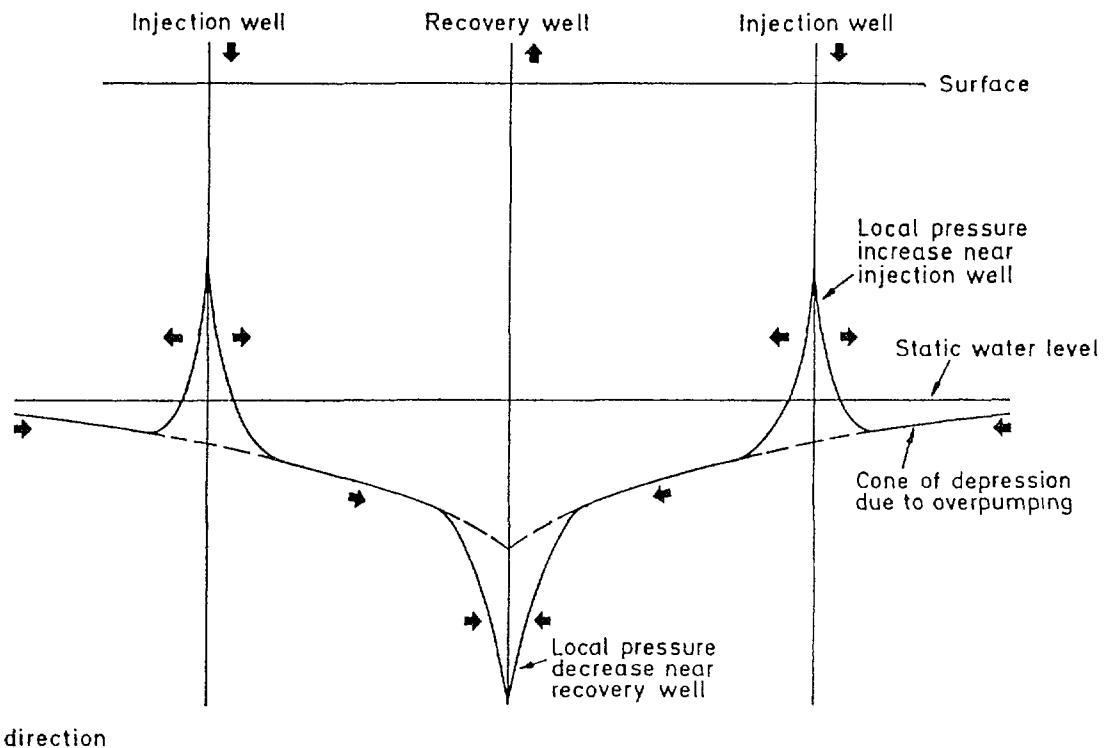

Figure 6.

Ruth - ISL
Pressure Distribution in a Leach Well Pattern
 Schematic

Other surface facilities were office and lab trailers, a warehouse, process gas tanks, utility power line and stand-by generator. Figure 7 is a plan of the surface situation at the test site.

A more detailed description of the plant and of plant operation is not a subject of this paper, though several novel process steps were included in the plant flowsheet. To mention is the chloride control circuit which was designed particularly in view of ease of restoration. In the conventional ion exchange process in an alkaline leach chemistry, the barren resin is in the chloride form. When the uranium bicarbonate complex is loaded onto the resin, chloride is kicked off in exchange. As the in situ leach is a closed circuit chloride concentrations are building up continuously in the recirculated lixiviant. High chloride concentrations can influence the resin loading capacity during operation and will definitely complicate restoration. At the Ruth facility the chloride control step was successful in reducing chloride concentrations in the lixiviant. Chloride control consisted of conditioning the eluted resin prior to bringing it back into the production stream from the wellfield. The resin was first stripped with an eluant solution containing 55 g/l sodium chloride and 4-10 g/l sodium

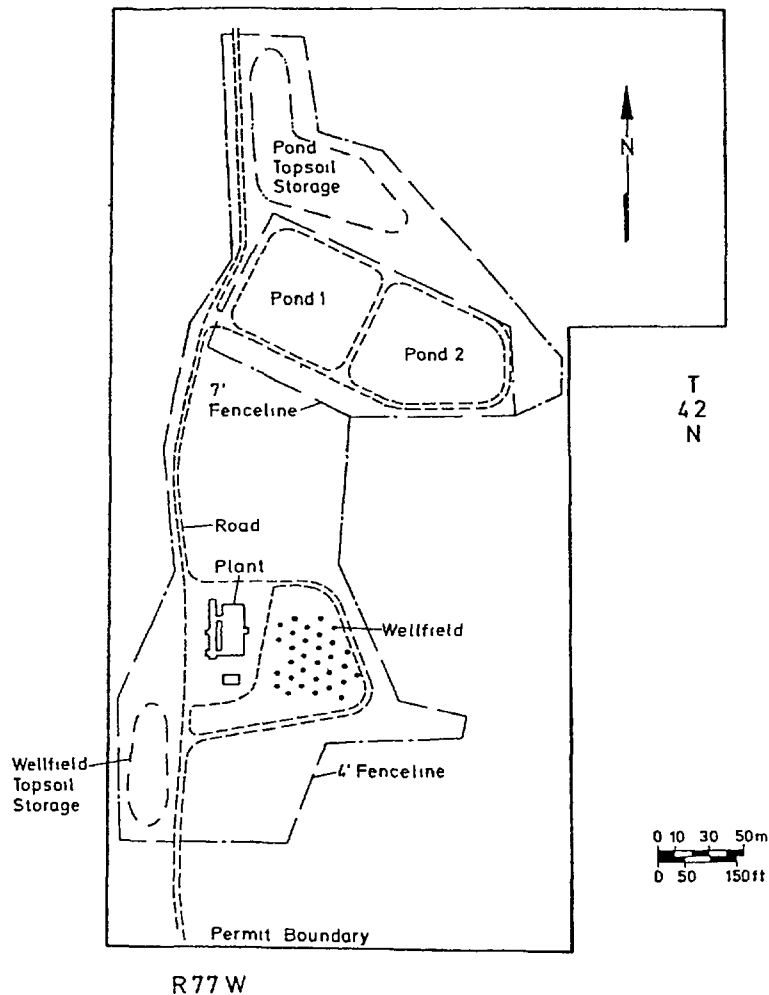

Figure 7.
Ruth - ISL
Site Plan

carbonate; after stripping the resin was in the chloride form. The resin was now conditioned with a strong sodium carbonate bicarbonate solution containing 35 g/l Na_2CO_3 and NaHCO_3 . The bicarbonate complex went onto the resin, while chloride was removed from the resin and from the process.

Leaching phase

Leaching commenced in February 1983 with the injection of carbon dioxide as first chemical into the wellfield. Purpose was to lower the pH from the natural value of 8,5 to the target of 7,0 and to condition the clay minerals to prevent clay swelling when later injecting sodium bicarbonate. Only small amounts of uranium were leached during this first step. Major uranium mobilization started only with the addition of oxygen in March 1983. When headgrades decreased after four weeks, indicating that the

easily leaching uranium was depleted, the addition of sodium bicarbonate was initiated in April 1983. The average headgrade reached about 130 ppm in June and slowly decreased thereafter (see Figure 8).

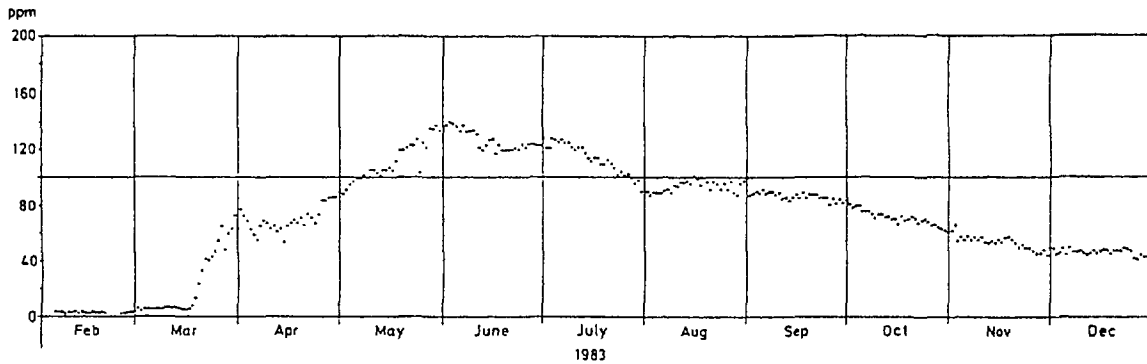

Figure 8.

Ruth - ISL

Uranium (U₃O₈) in Recovery Stream, Leaching Phase

In view of later groundwater restoration the uncontrolled escape of lixivants from the wellfield into the aquifer has to be avoided. Such an escape is called excursion and is the anxiety of any operator. An excursion during test plant operation requires immediate action and can result ultimately in plant shut down if not remedied.

At Ruth particular emphasis was put on wellfield flow balancing. At no time the injection rate was allowed to exceed the recovery. Flow balancing was both done for the wellfield as a whole and for each individual wellfield pattern. Balancing pattern by pattern became increasingly difficult towards the end of the leaching phase when the efficiency of some injection wells decreased. Well maintenance by swabbing and airlifting was very successful in restoring well injectivity and enabling patter flow balancing. - No excursion occurred during the leaching phase at Ruth.

The decision to discontinue leaching of a particular pattern or wellfield is in a commercial operation based on the general mining plan, e.g. when a new wellfield is brought on stream to maintain production, the low producing last wellfield may be shut down because of limited plant capacity. A simple criterion to cease leaching is reached when the value of uranium produced from a pattern or wellfield is less than the operating costs plus a predetermined profit margin.

In a pilot test this decision is depending upon the main purpose of the test. Restoration is probably relatively easy to achieve when the leaching process has not proceeded very far, but technical information will be limited. The longer the leaching lasts, the more complex the underground reactions become. Particularly trace metals as arsenic and selenium are likely to show up in the recovery stream in increasing concentrations.

The philosophy at the Ruth project was to leach as long as feasible in order gain confident information about uranium headgrades and orebody recovery rate, because this was sensitive for the overall economics of the leaching process. Information on restoration after extensive leaching was part of the information necessary to determine the feasibility of a commercial production.

Table 1

Pre-operational water quality baseline

	monitor well sampling		hydrology well sampling		wellfield sampling		drinking water standards
	<u>N</u>	<u>mean</u>	<u>N</u>	<u>mean</u>	<u>N</u>	<u>mean</u>	
Temperature, °C	42	13.4	16	12.6	32	14.3	
pH	42	8.6	16	8.53	32	8.64	6.9-9.0
Conductivity, µS	37	438	18	453	7	505	
TDS	42	333	18	326	31	345	500
Sodium	42	111	18	110	31	114	
Potassium	42	3.6	18	4.1	7	5	
Calcium	42	6.5	18	7.7	7	8	
Magnesium	42	1.9	18	2.1	7	1	
Sulfate	42	103	18	97	31	104	250
Chloride	42	6.0	18	6	31	6	250
Carbonate	39	15	16	9	31	25	
Bicarbonate	42	159	18	176	31	146	
Arsenic	38	0.008	15	0.014	7	< 0.005	0.05
Iron	42	0.07	18	0.09	7	< 0.01	0.3
Manganese	42	0.02	18	0.014	7	0.01	0.05
Molybdenum	42	< 0.05	18	< 0.05	7	< 0.05	
Selenium	41	0.005	16	< 0.005	7	0.02	0.01
Uranium (U ₃ O ₈)	42	0.006	18	0.03	7	0.01	5.896
Vanadium (V ₂ O ₅)	42	< 0.05	18	< 0.05	7	0.05	
Radium, pCi/l	38	4.1	18	133	7	55	5

All figures in ppm, unless otherwise indicated.

Drinking water standard for uranium is 5 ppm U.

Leaching at the Ruth-ISL site was maintained for 12 months and was discontinued in February 1984. The leaching curve (Figure 8) showed that depletion was almost achieved; the recovery rate was 74 % at that time. The oxygen addition was stopped first at the end of December 1983 followed in January 1984 by discontinuing bicarbonate addition, and finally carbon dioxide was shut down. Chemical composition of the recovery stream is shown in Table 2; uranium concentration was still 27 ppm at the end of the leaching phase.

Table 2

Recovery stream analysis at the end of leaching phase

	December 20, 1983	February 6, 1984
Temperature, °C	18.1	
pH	7.0	6.87
Conductivity, μ S	3420	2680
TDS	2426	
Sodium	835	513
Potassium	10	
Calcium	26	82
Magnesium	19	16
Sulfate	146	138
Chloride	564	480
Carbonate	24	0
Bicarbonate	1244	1025
Arsenic	0.16	0.065
Iron	< 0.03	
Manganese	0.64	
Molybdenum	< 0.01	
Selenium	4.40	2.62
Uranium (U_3O_8)	56.3	27.1
Vanadium (U_2O_5)	3.1	3.6
Radium, pCi/l	1780	906

All figures in ppm, unless otherwise indicated

Figure 9 through 12 show the pH and concentrations of major lixiviant constituents during the leaching phase.

Total production from the wellfield, including the uranium recovered during restoration, was 13 370 kg U (35 000 lb U_3O_8) and the average headgrade was

84 ppm. Calculated recovery rate amounted to 84 %, including restoration. Uranium produced during restoration was about 12 % of the total.

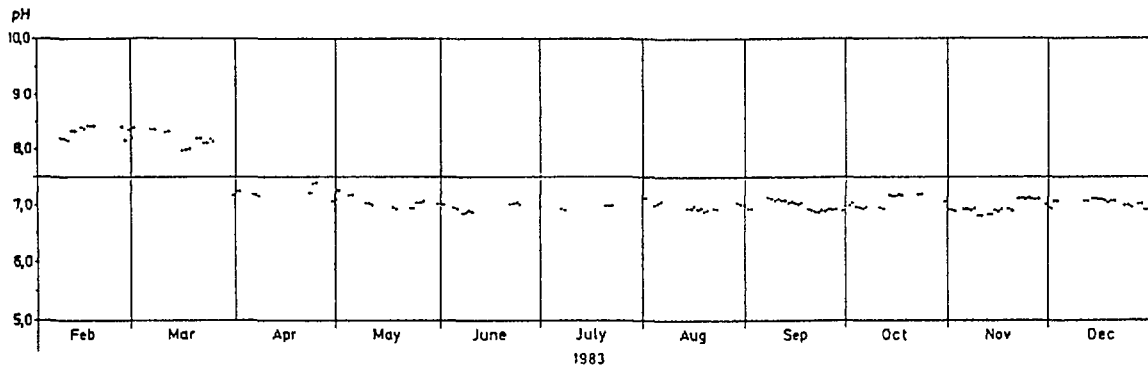

Figure 9
Ruth - ISL
pH in Recovery Stream, Leaching Phase

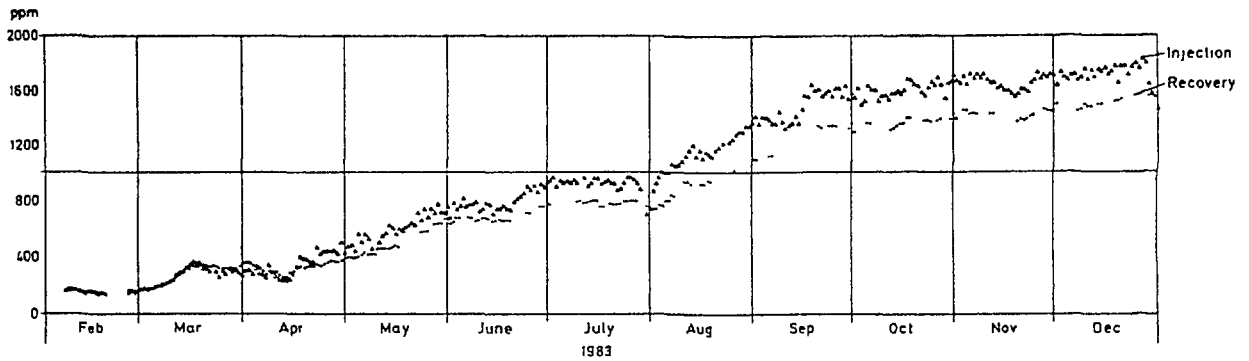

Figure 10
Ruth - ISL
Bicarbonate (HCO₃⁻) in Recovery and in Injection Stream, Leaching Phase

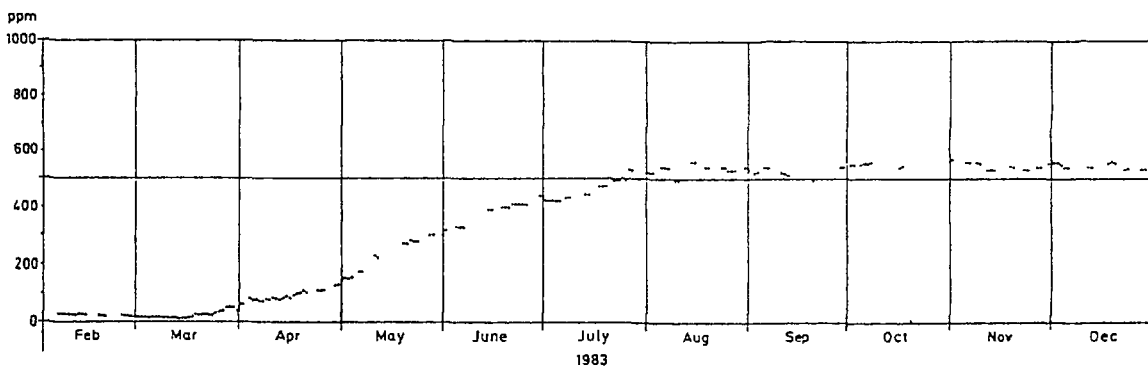

Figure 11
Ruth - ISL
Chloride (Cl⁻) in Recovery Stream, Leaching Phase

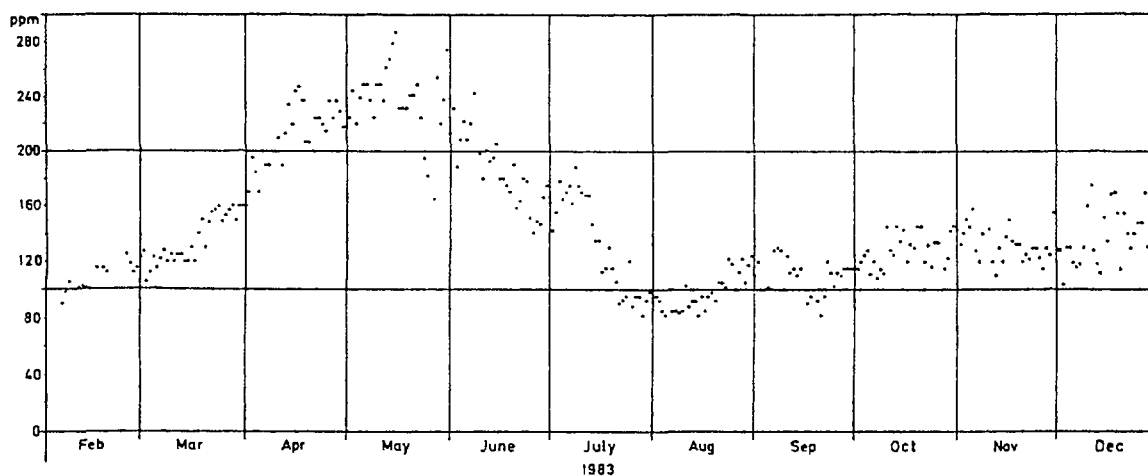

Figure 12.

Ruth- ISL

Sulfate (SO₄²⁻) in Recovery Stream, Leaching Phase

Restoration

Purpose of restoration is to restore the groundwater chemistry to the status as existing before leaching. The pre-operational baseline was established prior to injection of lixiviants by sampling hydrological test wells and monitor wells quarterly for at least one full season. On each sample 20 parameters were determined. The actual wellfield was sampled only once for confirmation just prior to start up of leaching.

As mentioned, restoration goal is generally the pre-operational groundwater use category, e.g. drinking water. But also within the use category a major deterioration of quality was not allowable. Therefore the regulatory agencies requested that restoration targets were mean baseline values; restoration had to be achieved on a parameter by parameter basis. At the Ruth-ISL site this was monitored by bi-weekly sampling the composite recovery stream from the wellfield. While restoration was in progress, the agencies requested that restoration must also be achieved on a well by well basis. This was not possible because the leach wells were only sampled once and thus no baseline for each well could be established.

The groundwater quality at Ruth is shown in Table 1, together with the drinking water standards for Wyoming. Three sets of data were available: from sampling the barren host sandstone, from sampling the orebody through hydrological test wells and from the one time wellfield sampling. All sets showed statistically significant differences and were therefore not

combined. Some of the wells were sampled for more than two years. The Wyoming Department of Environmental Quality used all three sets in their attempt to define restoration targets.

Groundwater use category at Ruth was determined by the DEQ as drinking water. The high radium concentrations, which made the water unsuitable for human consumption, did not qualify for a lesser use category, e.g. irrigation water or livestock use, because radium concentrations were considered treatable. The better the groundwater quality, the more difficult groundwater restoration becomes. In areas where water quality is low, e.g. Texas, restoration of in situ leach fields is relatively easy.

In most western states in the U.S., water supply, both surface and subsurface water, is scarce and draws considerable regulatory and public attention. Water is considered the most valuable commodity which has to be preserved for future generations and protected even for the price of limiting industrial development. Nebraska statutes e.g. forbid generally the use of or the injection of chemicals into drinking water aquifers for industrial purposes, unless a special groundwater use exemption is issued. Any exemption is contested severely by environmentalist groups, particularly when uranium and the nuclear industry is involved. - This is the background against which the importance of restoration has to be viewed in the U.S.

Restoration of pre-operational groundwater chemistry means removal of all lixiviant remains and of all mobilized compounds and trace metals, also restoration of the original pH. Three basic methods can be applied to achieve restoration:

1. The contaminated groundwater can be removed from the leach zone by pumping and is then replaced by fresh groundwater which is drawn into the wellfield area from outside the leach zone. This method is called groundwater sweep. Disadvantage is that large amounts of solutions have to be disposed off in ponds or discharged after treatment. Discharge into creeks or rivers is normally not permitted. Land application by spraying and deep well disposal are permissible since recently.
2. The recovered solution from the wellfield can be cleaned or purified before being reinjected. Contaminated groundwater in the aquifer is thus

diluted and finally displaced by clean injected solutions. This method requires a very efficient purification step, because reinjected contaminants will prolong the procedure. Ideally, the reinjected solution contains only concentrations at baseline values or below. A widely applied purification method is reverse osmosis or, less frequently, electro dialysis.

3. The third method consists of introducing a reagent into the aquifer in order to precipitate contaminants effectively. In use are reducing agents to precipitate trace metals, including uranium. Disadvantage of an injection of a reductant is, that any new chemical in the aquifer requires additional efforts to remove it too during further restoration.

All three methods were applied in course of groundwater restoration at Ruth, either separately or in combination. Groundwater sweep had to be used only to the extend absolutely necessary, because the Wyoming Department of environmental quality viewed this method not very favorably because it involved, in the agencies opinion, excessive groundwater consumption.

Another, though not acceptable method, is to inject large amounts clean water into all of the leach wells in order to push the contamination out of the wellfield area. Sampling the wellfield would than indicate successful restoration. Obviously, some operators had tried this method in the past. The Department of Environmental Quality requested that injection and recovery flow rates were reported routinely during restoration as proof for wellfield flow balance.

The Ruth restoration plan contained three steps. The first was removal of high concentrated lixivants from the aquifer by groundwater sweep. This was in order to relieve the second step, purification by reverse osmosis and re-injection. The efficiency of purification is low at high contaminant concentrations. A higher overpumping rate of 10% during the operation of the reverse osmosis during the second step was thought to create an additional sweep effect. The use of reductants in a third step of restoration was only planned as a tentative measure. The envisaged time to achieve restoration was six months or half the leaching time.

The reverse osmosis unit at Ruth was supplied by Polymetrics of San Jose, California. The membranes were fabricated by Desalination Systems of Escondido, California, and by Fluid Systems, San Diego, also California.

The membranes were made of cellulose acetate; later in 1984 all cellulose membranes were replaced by bacteria resistant polyamide thin-film composite (TFC) membranes. Membranes were spiral-wound to membrane cartridges placed in fiberglass vessels.

Design feed capacity of the unit was 227 l/m (60 gpm), with a maximum flow rate of 303 l/m (80 gpm) at 3450 kPa or 35 kp/cm² (500 psi). The unit consisted of four membrane stages. The unit was designed for a 1:9 split of the feed stream in 10% concentrated raffinate and 90% cleaned permeate, but during operation the raffinate was normally between 10% and 15% of the feed. The components of the reverse osmosis unit and their arrangement is shown in Figure 13.

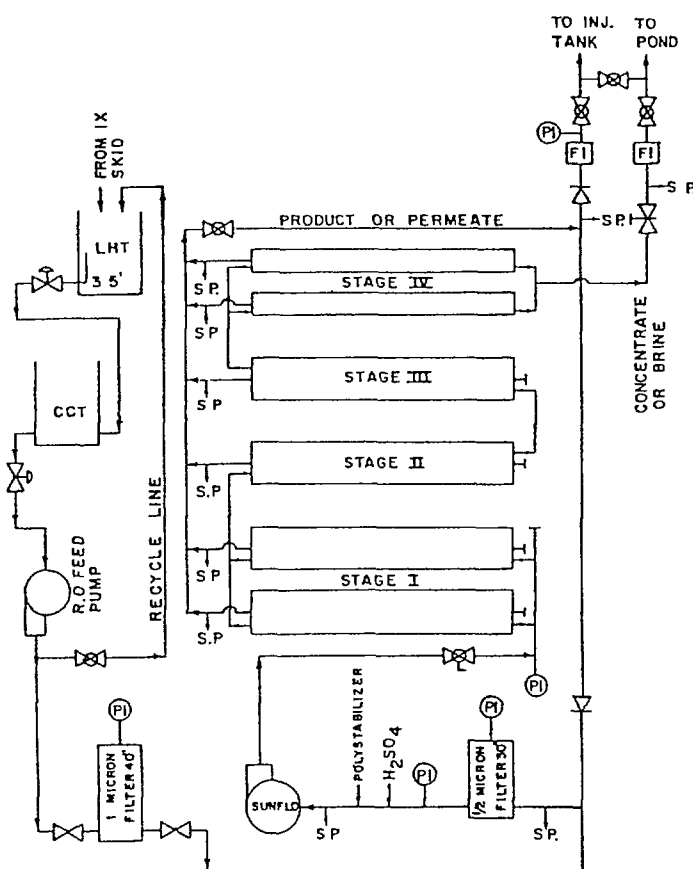

Figure 13.

Ruth - ISL

Reverse Osmosis Flow Diagram

Reverse osmosis is widely used for seawater desalination. The semi-permeable membrane acts as an ion sieve. The osmotic pressure gradient from the clean product side to the brine side of the membranes is overcome by a solution feed pressure higher than the osmotic pressure. Therefore, the

method is called reverse osmosis. Reverse osmosis units are very susceptible to changes of operating conditions. The membranes are easily fouled by calcite scaling or clogged by fines or gas bubbles. Reverse osmosis needs an experienced operating crew to function satisfactorily.

Groundwater restoration started at the Ruth project on February 6, 1984, as planned with groundwater sweep. All solutions were sent to the ponds. Wellfield injection and surface plant were shut down. Before wellfield circulation had been stopped, the recovery rate was as high as 490 l/m (130 gpm), but with the injection discontinued very quickly decreased to 180 l/m (48 gpm), limiting the effect of groundwater sweep. Therefore, and also to preserve pond capacity, the groundwater sweep mode was discontinued and the reverse osmosis unit put on stream on February 15, 1984.

Wellfield injection was resumed and the plant restarted. The surface plant operated in a configuration similar to the leaching phase, the only difference being that lixiviant make-up was not longer required. The reverse osmosis was installed after the ion exchange columns and before the injection surge tanks.

Most of the time the reverse osmosis was in operation, the recovery stream was depleted of uranium by ion exchange prior to being fed to the reverse osmosis. This was done because the wellfield in the beginning of the restoration still produced considerable amounts of uranium, but also because the large uranyl bicarbonate complex molecule was plugging the reverse osmosis membranes when recovery solution was fed directly to the unit.

The wellfield operated until March 19, 1984 in its original arrangement: injection into the injection wells and recovery from the seven production wells. Increases in uranium concentrations were proof that indeed the larger overpumping rate was drawing lixiviant from outside into the wellfield. However, the injection wells at the wellfield perimeter formed a pressure barrier and restricted the solution movement towards the inner recovery wells. On March 19, four of the seven submersible pumps were pulled from recovery wells and reset in former injection wells at the rim of the wellfield. Pumps were changed several times in the following weeks; end of April eight former injection wells were used as producers.

Converting perimeter injection wells into pumping wells proved to be very effective in halo recovery. Uranium headgrades, which had increased already in February, rose in March up to 90 ppm. Some wells reported grades between 200 ppm and 320 ppm. The highest single well headgrade during the entire test was found in March 19: the daily composite of hydrological test well 5L contained 474 ppm U_3O_8 .

The high uranium concentrations outside the wellfield area were caused by very slowly traveling lixivants resulting in long reaction times and high headgrades but they are not an indication for a high leaching efficiency.

High headgrades from halo recovery were only observed over a short period of days, thereafter they dropped again sharply. This indicated that the uranium had been concentrated in a small, but distinct front around the wellfield. A similar effect was found for bicarbonate, but not for other parameters assayed for.

When comparing the time elapsed between restoration start up and peak concentration arrival, a remarkable difference becomes evident: the bicarbonate peak appeared after 2-5 day, but the uranium peak showed up only after 10-21 days. Assuming a comparable speed of movement, the different times reflect different travel distances or different locations of the high concentration halos.

Despite the first success in restoration, it became very soon clear that restoration would require much more time than the originally allotted six months. Contaminant concentrations decreased slower than expected.

A plan to drill additional sweep wells between wellfield and monitor wells was abandoned. The wells were to be used as injection wells for reverse osmosis product or as additional pumping wells. But as the exact position of the lixiviant plume outside the contiguous leach wellfield was not known, adverse effects could not be precluded.

Reverse osmosis product quality was in April not sufficient to justify prolonged reinjection. Increased pond disposal was necessary, but limited pond capacity became a growing concern. The situation was impounded end of April when a severe winter storm filled the ponds with drifting snow.

The Wyoming Department of Environmental Quality issued a discharge permit for the Ruth-ISL facility on May 17. Solution mining operations are normally licensed as strictly non-discharge operations, but as the Ruth project had passed the operational status and was in restoration, an exemption was granted.

Main purpose of the planned discharge was to go back to a groundwater sweep mode of restoration without disposing the entire volume of recovered solution into the ponds. At the end of April concentrations of all major constituents and parameters were close to restoration targets, except uranium, radium, selenium, vanadium and arsenic. Restoration target for the three latter was the detection limit as they had not been found in the water quality baseline.

Groundwater sweep and discharge of reverse osmosis product from the first membrane stage commenced on May 24, 1984. At the same time, a small flow of 11 l/m (3 gpm) was recycled from the ponds to the reverse osmosis feed.

Recycling pond solution was intended to preserve pond capacity, but was in fact detrimental for the operation of the reverse osmosis unit. A complete membrane set was severely damaged and partially destroyed on July 11, during unit cleaning with citric acid. This was caused by bacterial hydrolysis of membrane material. A second set was slightly damaged. Bacterial action could be successfully suppressed by addition of hypochloride to the feed. Groundwater sweep continued with discharge from the reverse osmosis until September 19, 1984, when membranes of another type were installed. The new membranes were bacteria proof and had a better efficiency.

Concentrations of uranium, selenium, arsenic and vanadium had remained practically unchanged since May and June. They even started very slowly to increase after August. Table 3 shows months end concentrations of the four elements and their restoration target values.

By end of September about 27 250 m³ (7.2 M gallons) of water were removed from the aquifer. This constituted a total of 4.2 pore volumes. It became obvious that a continuation of recirculation of even better quality reverse osmosis permeate would not achieve aquifer restoration within an acceptable time frame.

Table 3

Trace element concentrations during
groundwater restoration phase
(months end)

<u>1984</u>	<u>Uranium</u>	<u>Selenium</u>	<u>Arsenic</u>	<u>Vanadium</u>
January	30.3	2.62	0.065	2
February	47.4			2
March	67.4	0.62	0.60	0.56
April	18.6	0.78	0.21	0.73
May	7.0	0.47	0.38	1.17
June	4.4	0.42	0.16	0.59
July	7.2	0.46	0.17	0.97
August	3.4	0.18	0.10	0.53
September	2.4	0.25	0.14	0.59
October	0.5	0.54	0.25	0.45
November	0.6	0.25	0.42	1.01
December	0.2	0.01	0.98	0.49
January 10, 85	0.028	0.01	0.036	0.07

All figures in ppm, vanadium reported as V

Source of elevated trace metal concentrations was mainly an ongoing leach reaction underground and only to a minor degree lixiviant remainders. A strong reductant was to be introduced to stop any ongoing chemical leach and to precipitate the reduced metals.

Several reductants were tested in the lab and in the field in selected wells. Among the tested sodium thiosulfate ($\text{Na}_2\text{S}_2\text{O}_3$), sodium sulfide (Na_2S) and hydrogen sulfide (H_2S), the latter was the most effective, but also the most hazardous. The field personnel hesitated to use hydrogen sulfide; an intensive safety training program was initiated.

Injection of hydrogen sulfide was started on November 15 and lasted until December 28, 1984. This injection successfully completed groundwater restoration. A total of 3860 kg (8500 lb) was injected. The reductant was delivered liquid in 5450 kg (12 000 lb) tank trucks. To create the necessary gas pressure to convey the liquid to the well heads, the tank was heated by warm ethyl glycole. Stainless steel lines, diameter 1/4" and 3/8", were used for distribution. The injection well head consisted of a

flow indicator and a pressure regulator. The liquid was added at the wellhead to the injected reverse osmosis permeate. Four to five wells were operated as recovery wells in order to maintain circulation for improved contact of hydrogen sulfide with the leaching zone. Injection and recovery was again changed several times until all wells had received the reductant. Average calculated quantity was 113 kg (250 lb) per well at a concentration of 0,5 g/l.

Breakthrough of hydrogen sulfide could be observed in some recovery wells after several days, but the total amount of hydrogen sulfide returning was minimal. Whenever a break through occurred, the well was shut down in order to prevent the gas to enter the plant building. When returning concentrations reached 50 ppm the plant was shut down; that occurred three times.

Chemical effects of hydrogen sulfide injection was the complete reduction of uranium, vanadium, arsenic and selenium. Concentrations of these elements before and after the injection are shown in Table 4. Other effects

Table 4

Effects of hydrogen sulfide injection
(November 15 - December 27, 1984)

	<u>November 8</u>	<u>November 26</u>	<u>January 10</u>
Temperature, °C			17.9
pH	8.7	8.6	6.3
Conductivity, µS	276	251	277
TDS	114	140	189
Sodium	69	65	56
Potassium		1	2
Calcium	5	5	7
Magnesium		1	0
Sulfate	28	28	91
Chloride	10	8	7
Carbonate	7	5	0
Bicarbonate	125	134	44
Arsenic	0.28	0.37	0.03
Iron		< 0.03	0.47
Manganese		0.04	0.15
Molybdenum		0.02	< 0.01
Selenium	0.46	0.057	< 0.01
Uranium (U ₃ O ₈)	0.60	0.505	0.041
Vanadium (V ₂ O ₅)	1.49	1.60	0.12
Radium, pCi/l	30	18	41

All figures in ppm, unless otherwise indicated.

were the lowering of pH to about 6.5 from a high of 8.8 and a slight increase of sulfate and chloride concentrations. Only traces of the hydrogen sulfide were oxidized to sulfate, the majority hydrolyzed under oxidation to water and elemental sulfur. The sulfur showed up as grey sludge on the injection filters in the plant. - The success of the hydrogen sulfide injection was not only the effective suppression of trace metals but also the fact that no major chemical species was introduced to the aquifer or increased in concentration, like sulfate, requiring additional restoration efforts.

Changes in uranium concentrations, in pH-values and in concentrations of several other solution constituents during restoration are shown in Figure 14 through 18. The pH-value very quickly recovered from the operational level of 7 or slightly below. Short downward changes in March and April reflect effects of halo recovery. Baseline values were reached in November, but the hydrogen sulfide injection lowered the pH again to 7.5-8.0. Increases in uranium concentrations in February through March due to halo recovery are quite obvious. After April the values followed again the overall downward trend.

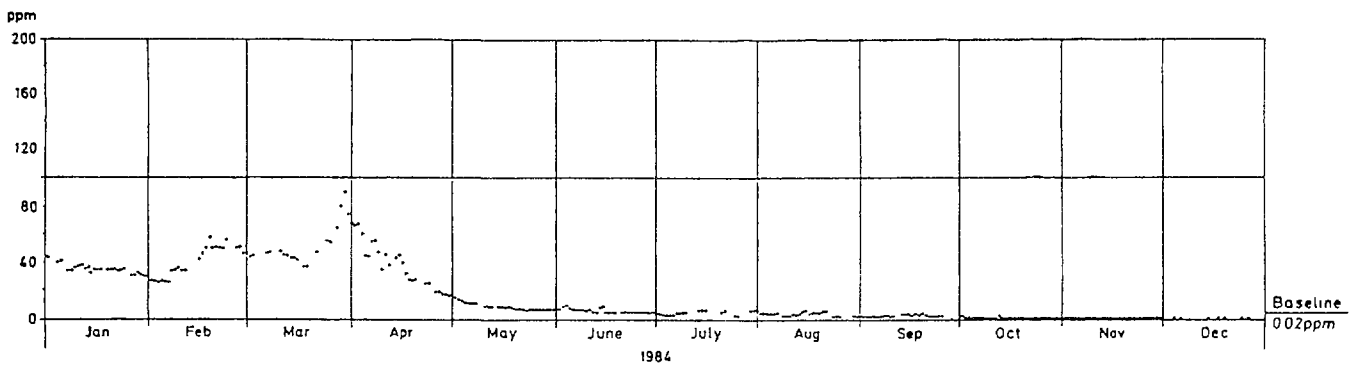

Figure 14.

Ruth- ISL

Uranium (U₃O₈) in Recovery Stream, Restoration Phase

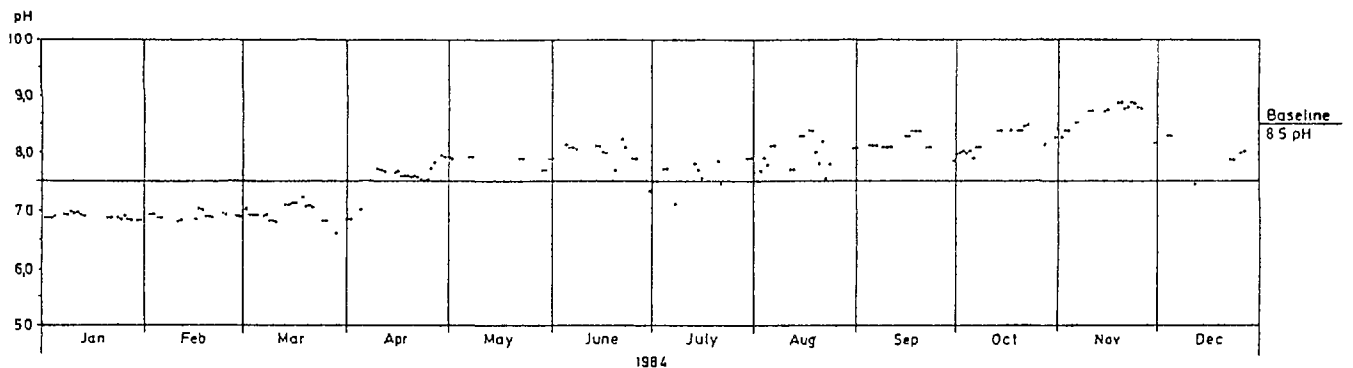

Figure 15.

Ruth- ISL

pH in Recovery Stream, Restoration Phase

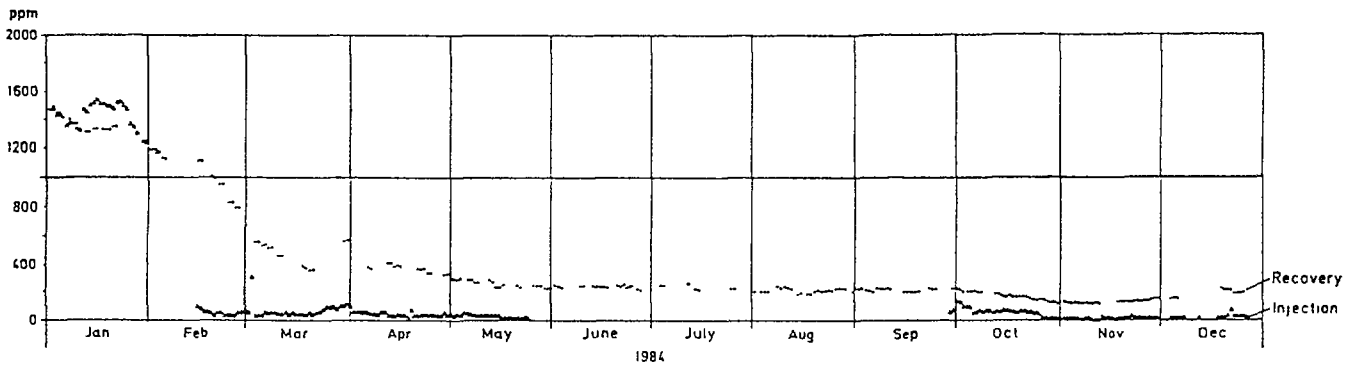

Figure 16
Ruth - ISL
Bicarbonate (HCO₃⁻) in Recovery and in Injection Stream, Restoration Phase

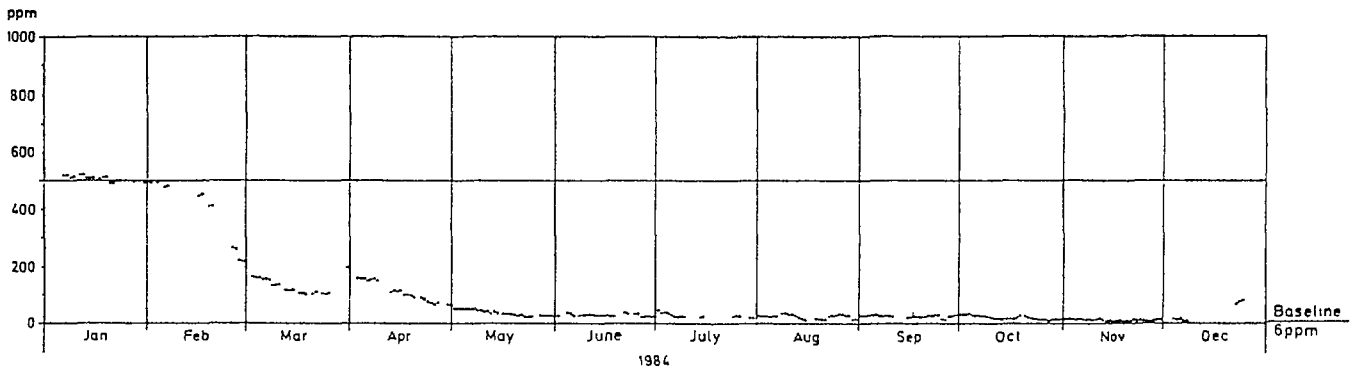

Figure 17
Ruth - ISL
Chloride (Cl⁻) in Recovery Stream, Restoration Phase

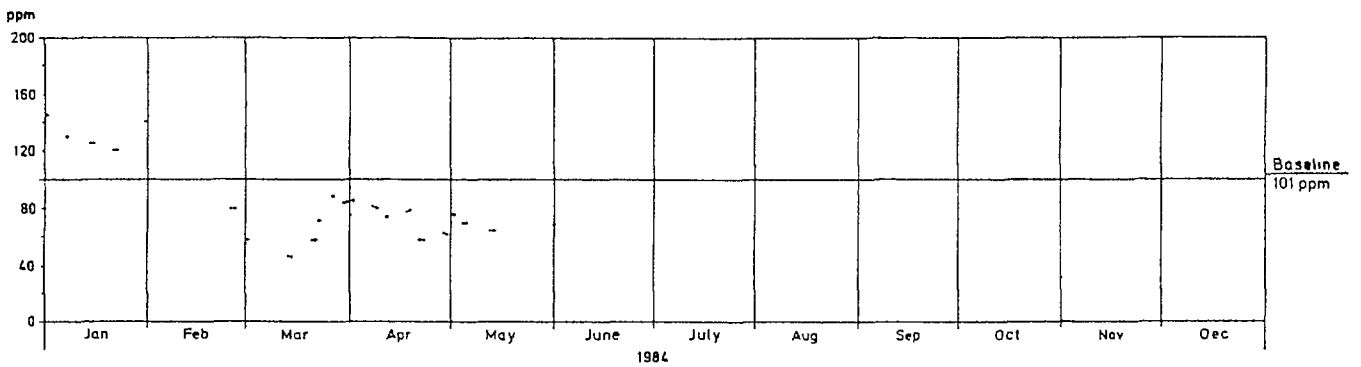

Figure 18
Ruth - ISL
Sulfate (SO₄²⁻) in Recovery Stream, Restoration Phase

Based on the experience at Ruth, restoration in a future commercial operation can be planned more efficiently. The first step will be groundwater sweep to remove most of the injected lixiviant from the aquifer. Second step will be purification with reinjection of purified solution. As soon as some species like bicarbonate, sulfate, chloride reach drinking water standarts, hydrogen sulfide treatment will be applied. A second purification step may follow, if necessary.

Stabilization

Stabilization phase commenced in January 1985. Before wellfield circulation was discontinued, the regulatory agencies were invited to take split samples. Assay results of the operator and of the agencies both confirmed that restoration was achieved. Table 5 shows results of confirmation sampling and, for comparison, the restoration targets. The assay results indicated that uranium, vanadium and selenium were effectively reduced, arsenic only to some extend. Iron was found to be slightly increased, which had not been expected.

Table 5

Restoration confirmation sampling January 1985

	wellfield actual	restoration target	drinking water standard
Temperature, °C	17.93	13.5	
pH	6.25	8.5	6.9-9.0
Conductivity, µS	277	516	
TDS	189	335	500
Sodium	56	112	
Potassium	1.7	4	
Calcium	7.1	7	
Magnesium	0	2	
Sulfate	91	101	250
Chloride	7.5	6	250
Carbonate	0	20	
Bicarbonate	44	161	
Arsenic	0.03	0.011	0.05
Iron	0.47	0.07	0.3
Manganese	0.15	0.01	0.05
Molybdenum	< 0.01	0.01	
Selenium	< 0.01	0.01	0.01
Uranium (U ₃ O ₈)	0.41	0.017	5.897
Vanadium (V ₂ O ₅)	0.12	0.05	
Radium, pCi/l	41	111	5

All figures in ppm, unless otherwise indicated.

Drinking water standard for uranium is 5 ppm U.

Before confirmation sampling, pumps were set in eleven wells designated as stabilization monitoring wells. Six were former injection wells and five were former recovery wells. These wells were sampled every four weeks until the end of the restoration phase.

The ultimate restoration success depends upon the behavior of the parameters monitored during stabilization. The list is the same as for baseline sampling and for restoration sampling. Experience is, that the values achieved during restoration tend to increase over some period of time and then level off and stabilize. This indicates that all chemical reactions underground have ceased and aquifer chemistry is stable. The slow increase of concentrations is attributed to a homogenization process by diffusion.

Some parameters showed no increase and were stable from the beginning, e.g. chloride, or even decreased, e.g. arsenic and vanadium. Selenium was below detection limit all time. Figure 19 shows graphically the changes for nine of the major parameters, except selenium. All values reached a plateau after some time. Bicarbonate and pH displayed slow increases and late stabilization. Arsenic and vanadium decreased remarkably during the first months of 1985, but arsenic concentrations increased again after June, however, not reaching the January level again. Whether this increase was caused by the well treatment described below, is not clear. Uranium concentrations reached the plateau after seven months, radium already after three months. Sulfate, not shown in Figure 19, reached a peak in April, but dropped back in July and stabilized on a lower level.

Most surprising was the increase for iron and manganese. Both elements had not been mobilized during leaching and their concentrations had always been at or below detection limits. Particularly the strong increase of iron concentrations caused some concern. The reasons were not easily understood. A possible explanation was that some scaling in the completed well intervals caused a contamination in the immediate vicinity of the well bore. Three wells were selected for a well bore overhaul. Wells 5S and 16S (Figure 4) had both reached an iron concentration of 13 ppm in May as compared to an average of 1.2 ppm for the other nine sampling wells. Well 29S was chosen because of its high manganese concentration of 2.3 ppm as compared to 0.4 ppm. Wells 5S and 16S were former injection wells; 29S was a recovery well. All three wells were re-underreamed from 17.8 cm (7 inch)

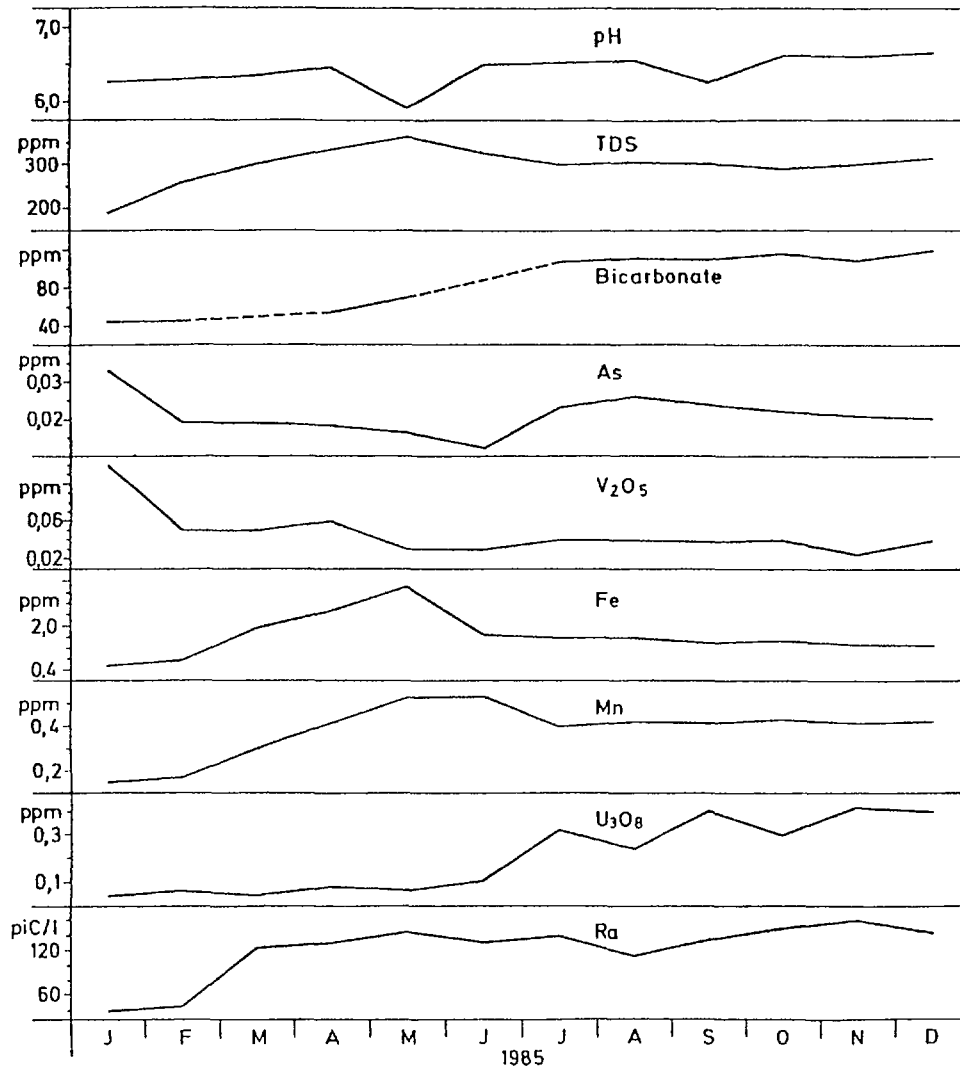

Figure 19.
Ruth - ISL
Stabilization Phase Assays, Average of All Sampling Wells

to 22.7 cm (9 inch) and airlifted for several hours. Also sampling procedures were changed: instead of pumping 1890 l (500 gallons) of water prior to sampling now 3790 l (1000 gallons) were pumped. These measure decrease the concentrations of iron, manganese, and also sulfate in samples taken after the well treatment. The higher values had been indeed caused by well bore contamination.

Looking at the calculated monthly averaged values only, as shown in Figure 19, eliminated the differences between the individual sampling wells. This was acceptable for the regulatory agencies to monitor the overall stabilization success. In Figure 20 are shown, as an example for the variances within the wellfield, the changes of iron concentrations in all eleven sampling wells during stabilization. It becomes obvious that

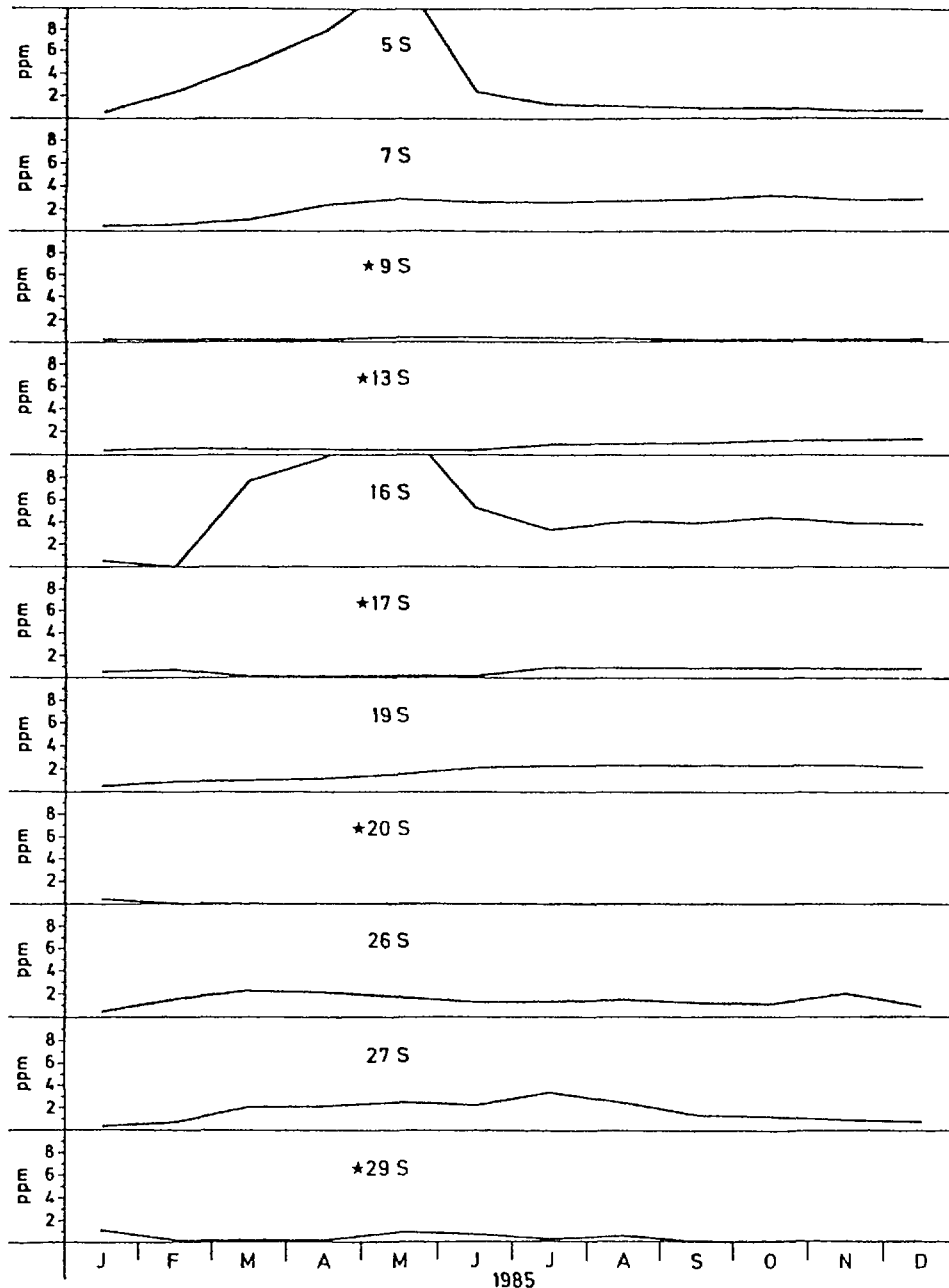

Figure 20.

* Indicates a former recovery well

Ruth - ISL

Stabilization Phase, Iron in Individual Sampling Wells

high iron concentrations were contributed by two wells only. The other wells had relatively low concentrations, particularly well 20S. The formation of a plateau can be seen very clearly in iron concentrations from wells 7S, 17S and 19S. Generally, the former recovery wells show lower concentrations than the injection wells. This is another indication that iron and manganese built-up during stabilization was caused by well interface contamination.

A similar correlation between well use and concentration was not possible for radium. Radium was critical, because some wells had very high concentrations. The average is somewhat misleading, because considerable differences existed between the wells, e.g. in June the lowest concentration was 23 pCi/l in well 20S, the highest 451 pCi/l in well 29S. Some wells had not leveled off at the end of stabilization, but this was fortunately balanced by other wells with decreasing concentrations. Five wells - 7S, 13S, 17S, 19S, 26S - reached peak concentrations of 149-424 pCi/l in the last quarter of 1985.

The December 1985 sampling concluded the 12 months stabilization period. All parameters were still below or at least very close to restoration targets, except iron, manganese and radium, which were even above drinking water standards. Despite higher concentrations of the elements, the regulatory agencies approved the stabilization success. They acknowledged that radium baseline was higher than drinking water standard and that wellfield baseline sampling had shown large variations in radium concentrations (Table 1). They acknowledge also that limits for iron and manganese were imposed for drinking water not because of their hazardousness but solely for aesthetic reasons (smell, color).

Radium is considered treatable up to a concentration of 100 pCi/l. Above that limit, water treatment to reduce radium levels to drinking water standards is thought to be not justified.

In spring of 1986 both the DEQ and the NRC signed off on groundwater restoration and stated that "the Ruth project is suitable as a demonstration for a commercial permit". They also stated that the project was the most thoroughly planned and operated, and one of the best documented in situ leaching pilot test operations in Wyoming so far.

IN SITU LEACHING OF YOZGAT-SORGUN-TEMREZLI URANIUM DEPOSIT – RELATED LABORATORY EXPERIMENTS

G. ÖNER, G. NASÜN, A.I. ÇATALTAŞ, H. OKUTAN
Department of Chemical Engineering,
Istanbul Technical University,
Istanbul, Turkey

Abstract

This paper presents data on mineralogy and laboratory chemical-leaching tests for the blended ore sample from several areas of Yozgat-Sorgun-Temrezli formation. The uranium ore samples were taken from the different well corings by Mineral Research and Exploration Institute of Turkey. The main objective of this study was to investigate the leaching performance of Yozgat-Sorgun-Temrezli uranium ore under in-situ leaching conditions in the laboratory. For this purpose first XRD and various chemical analyses were performed; and, batch, autoclave and column pack leach tests were carried out with several acid and alkaline systems. The systems used as lixiviant were HNO_3 , $\text{H}_2\text{SO}_4\text{-H}_2\text{O}_2$, $\text{H}_2\text{SO}_4\text{-MnO}_2$, $\text{Na}_2\text{CO}_3\text{-NaHCO}_3\text{-H}_2\text{O}_2$, $\text{K}_2\text{CO}_3\text{-KHCO}_3\text{-H}_2\text{O}_2$ and $(\text{NH}_4)_2\text{CO}_3\text{-NH}_4\text{HCO}_3\text{-H}_2\text{O}_2$.

Although XRD examinations showed that the main minerals were SiO_2 , Al_2O_3 and CaCO_3 , no specific uranium mineral was detected on the blended uranium ore sample. Batch and autoclave leach tests indicate that 0.1M $\text{H}_2\text{SO}_4\text{-0.3g/l H}_2\text{O}_2$ is the most desirable leachate for extracting this ore. Column pack leach tests confirmed that U_3O_8 could be leached rapidly and to high recoveries (95%) using sulfuric acid-peroxide solution.

Sodium carbonate was found to be the most effective alkaline system. Batch leach tests indicated that the optimum carbonate and bicarbonate concentrations were 0.085 M and 0.015 M respectively and the addition of hydrogen peroxide to the extraction solution always increased the yield of uranium. Fifty seven percent recovery was obtained with 0.085 M $\text{Na}_2\text{CO}_3\text{-0.015 M NaHCO}_3\text{-2g/l H}_2\text{O}_2$ lixiviant. Similar results observed during alkaline column leach test.

Preliminary laboratory leaching tests proved the applicability of in situ uranium leaching process for Yozgat-Sorgun-Temrezli uranium deposit.

1. INTRODUCTION

Uranium ore is mostly found as low grade reserves (less than 1%) in different regions of Turkey. The uranium reserves of Turkey amounts to 8400 metric tonnes of U_3O_8 equivalent in the reasonably assured category. The average grade of these deposits is 0.05 %. Table 1 summarizes the uranium deposits found in Turkey dating back to 1984 (1,2).

Table 1- Uranium Ore Deposits Found in Turkey (2).

Location	Grade (% U_3O_8)	Reserve(metrictonnes)
Salihli-Köprübaşı	0.05	3.040
Uşak-Eşme-Fakılı	0.045	510
Aydın-Söke-Küçükçavdar	0.05	500
Aydın-Söke-Demirtepe	0.08	1.300
Çanakkale-Ayvacık-Küçükkuyu	0.08	250
Giresun-Şebinkarahisar	0.04	300
Yozgat-Sorgun	0.10	2.500
		Total : 8.400

According to last report of Mineral Research and Exploration Institute of Turkey (MTA), an important uranium ore deposit with U_3O_8 content 0.1 % was found near Yozgat-Sorgun area which is located at Central Anatolia. The reserve is underground formed uranium deposit. It is estimated to be 2400 metric tonnes U_3O_8 and depth of the mineral is about 100 m (3).

2. PURPOSE OF STUDY

Several technological leaching studies of Yozgat-Sorgun Uranium ore had been carried out at the Technology Laboratories of MTA. The main objectives of these studies were to determine the hydrometallurgical conditions such as chemical reagent amount, particle size range of the ore, solid-liquid ratio, leaching time and temperature (4,5).

As mentioned in Introduction section, Yozgat-Sorgun-Temrezli uranium reserve is an underground formed uranium ore. In Situ leaching of uranium has been proven to be one of the most economical processes for recovering this metal especially from lower grade deposits. For this reason, it has

been thought that it is necessary to investigate the applicability of in situ leaching technique for recovering Yozgat-Sorgun-Temrezli uranium deposit.

The main objective of this study was to investigate leaching performance of Yozgat-Sorgun-Temrezli uranium ore under in situ leaching conditions in the laboratory. For this purpose; batch, autoclave, and column pack leach tests were conducted with several acid and alkaline systems with oxidant.

3. EXPERIMENTAL PROCEDURES

Field Sample Selection and Preparation

The blended uranium ore sample was used during the laboratory leaching tests. This blended uranium ore sample was obtained from Technology Laboratories of MTA. Ten different well corings were blended representing Yozgat-Sorgun-Temrezli area by MTA (4). A schematic arrangement of drilling operations is shown in Figure 1. Table 2 summarizes depth and U_3O_8 grade of ten well core samples (301, 302, 303, 304, 305, 308, 310, 313 and 315). A screen analysis of the blended sample is presented in Table 3.

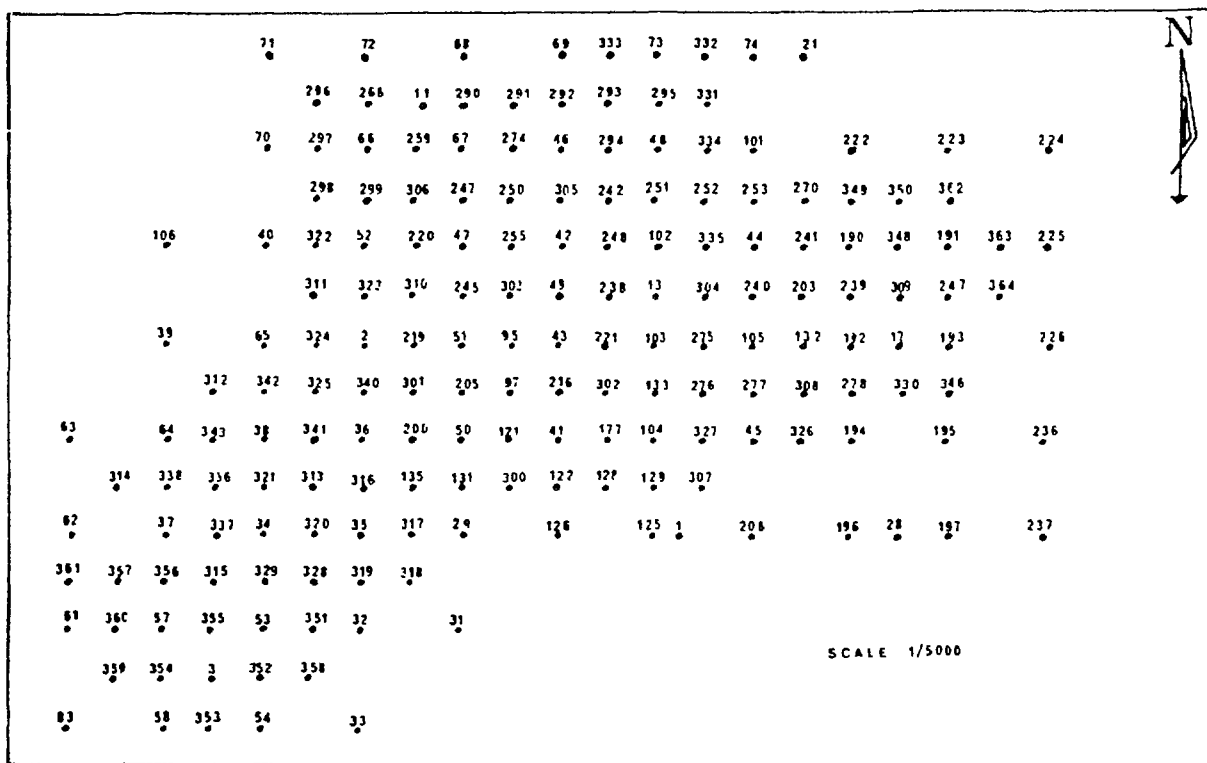

Figure 1- Drilling Location of Yozgat-Sorgun-Temrezli Uranium Area

Table 2- Core Samples Description of Yozgat-Sorgun-Temrezli Uranium Formation (4).

Area Well No.	Sample No.	Amount (g)	% U ₃ O ₈	Depth (m)
301	15	108	0.1100	109.27- .40
	16	313	0.1100	.40- .55
	17	276	0.0900	.55- .70
	18	328	0.0600	.70-109.85
302	1	552	0.0800	120.90-121.20
	2	329	0.1400	.20- .40
	3	346	0.2080	.40- .60
	4	420	0.1220	.60- .80
	5	376	0.0380	.80-122.00
	18	395	0.0280	172.80-173.00
	19	308	0.0530	.10- .30
	20	275	0.1170	.30- .60
	21	302	0.1770	.60-173.80
	22	378	0.048	173.80-174.00
	31	320	0.4300	180.00- .20
	32	338	0.5800	.20- .40
	33	461	0.0260	.40-180.60
303	6	150	0.0950	56.90-57.00
	7	162	0.0650	.00- .00
	8	377	0.0950	.10- .30
	9	336	0.0250	.30-57.50
304	3	231	0.1700	117.45-117.60
	4	423	0.0700	.60-118.00
	5	810	0.1400	118.00- .70
	6	940	0.1000	.70-119.40
	7	1168	0.0600	.40-120.40
	10	447	0.0850	152.30- .90
	11	1060	0.0270	.90-153.80
	12	644	0.0230	.80-154.50
	13	1400	0.2100	.50-155.50
	14	1180	0.0140	.50-156.40
	27	620	0.0315	162.10- .40
	28	465	0.2100	.40- .70
	29	550	0.3300	.70-163.00
30	392	0.0370	.00-163.30	

Table 2 (cont.)

Area Well No.	Sample No.	Amount(g)	% U ₃ O ₈	Depth (m)
304	32	392	0.1500	171.80-172.00
	33	455	0.4400	.00- .20
	34	466	0.4000	.20- .40
	35	443	0.2200	.40- .60
	36	348	0.1400	.60- .80
	37	440	0.0600	172.80-173.00
	38	413	0.0230	.00- .20
	39	450	0.0210	.20- .40
	40	902	0.0200	.40-173.80
305	32	1034	0.2000	148.50-149.00
	33	675	0.0140	.00- .30
	34	401	0.0700	.30-149.50
308	4	300	0.4300	130.70- .90
	5	370	0.3400	.90-131.10
	6	372	0.1200	.10- .30
	7	233	0.0240	.30- .50
	8	442	0.0195	.50- .70
	9	393	0.0055	.70- .90
	10	435	0.0030	.90-132.20
310	11	339	0.3200	.20-132.50
	10	509	0.0400	120.10-120.40
	11	674	0.1500	.40- .70
	12	728	0.0800	.70-121.00
	31	1085	0.1400	121.60-130.00
	32	1360	0.2000	.00-130.50
	36	906	0.1200	132.00- .40
37	906	0.0450	.40-132.80	
313	7	360	0.2200	91.30- .50
	8	330	0.1400	.50- .70
	9	340	0.0600	.70- .90
	10	545	0.0450	.90-92.10
315	11	300	0.0800	104.00- .20
	12	500	0.2700	.20- .40
	13	390	0.5000	.40- .60
	14	380	0.6000	.60- .80
	15	350	0.2800	.80-105.00
Total	71	36146	0.1492	

Table 3- Screen Analysis of The Blended Ore Sample

Sieve Size (mm)	Amount (g)	%
+0.355	21.61	21.61
-0.355, +0.150	35.83	57.44
-0.150, +0.106	16.37	73.81
-0.106, +0.075	9.51	83.32
-0.075	16.67	-
Total : 99.99		

Sample Characterization

To characterize the blended ore sample X-ray diffraction and various chemical analysis, such as U_3O_8 , SiO_2 , Al_2O_3 , Fe_2O_3 , CaO , MgO , Na_2O , K_2O , CO_2 , SO_3 were performed.

Laboratory Leach Experiments

Batch, autoclave and packed column leach tests were used to evaluate the leach rate and recovery of U_3O_8 from blended ore sample of Yozgat-Sorgun-Temrezli uranium deposit with several acid and alkaline systems. During leach tests, 2 ml samples were taken from the leaching solutions at different times and U_3O_8 concentration was measured, U_3O_8 analysis was carried out by a modified calorimetric method of Johnson and Florence (6).

Batch Tests: Batch tests were carried out in glass flask mounted on a shaker apparatus and employed small amounts of blended ore (25 g) and leach solution (250 ml). Several acid and alkaline systems were investigated in order to determine the most suitable lixiviant for the leaching process. Also H_2O_2 and MnO_2 were added as an oxidant to the leaching media. The systems used as lixiviant were HNO_3 , H_2SO_4 , $H_2SO_4-H_2O_2$, $H_2SO_4-MnO_2$, $Na_2CO_3-NaHCO_3-H_2O_2$, $(NH_4)_2CO_3-NH_4HCO_3-H_2O_2$, $K_2CO_3-KHCO_3-H_2O_2$.

Autoclave Tests: Autoclave tests were conducted using two liter magnet stirred type autoclave, made by Andrea's Hoffer Co. The experiments were repeated with acid and alkaline lixiviant systems in autoclave. All autoclave tests were made under 8 atm nitrogen pressure. Cooling coils were inserted in the units. Temperature was maintained at 16 degrees

centigrade. All tests were run with initial solutions to solids in the ratio of 10:1 (50 g ore sample and 500 ml leach solution). During leach tests, all samples were agitated continuously at 600 rpm except for brief intervals to sample the solution.

Column Pack Tests: To more closely simulate field leaching conditions several column pack leach tests were performed in glass tubes about 3.72 cm in diameter and 30-60 cm long. 100-200 g of crushed ore was used during column pack tests. Schematic diagram of column leaching apparatus was shown in Figure 2. Small plugs of sand and glass wool were placed in the bottom of each pack prior to packing with ore. The lixiviant was fed from the top by the inlet pump. Leachate liquor was pumped from the bottom of the column to a collection reservoir by an outlet pump. To maintain the constant pressure gradient across the column, a vacuum pump was used.

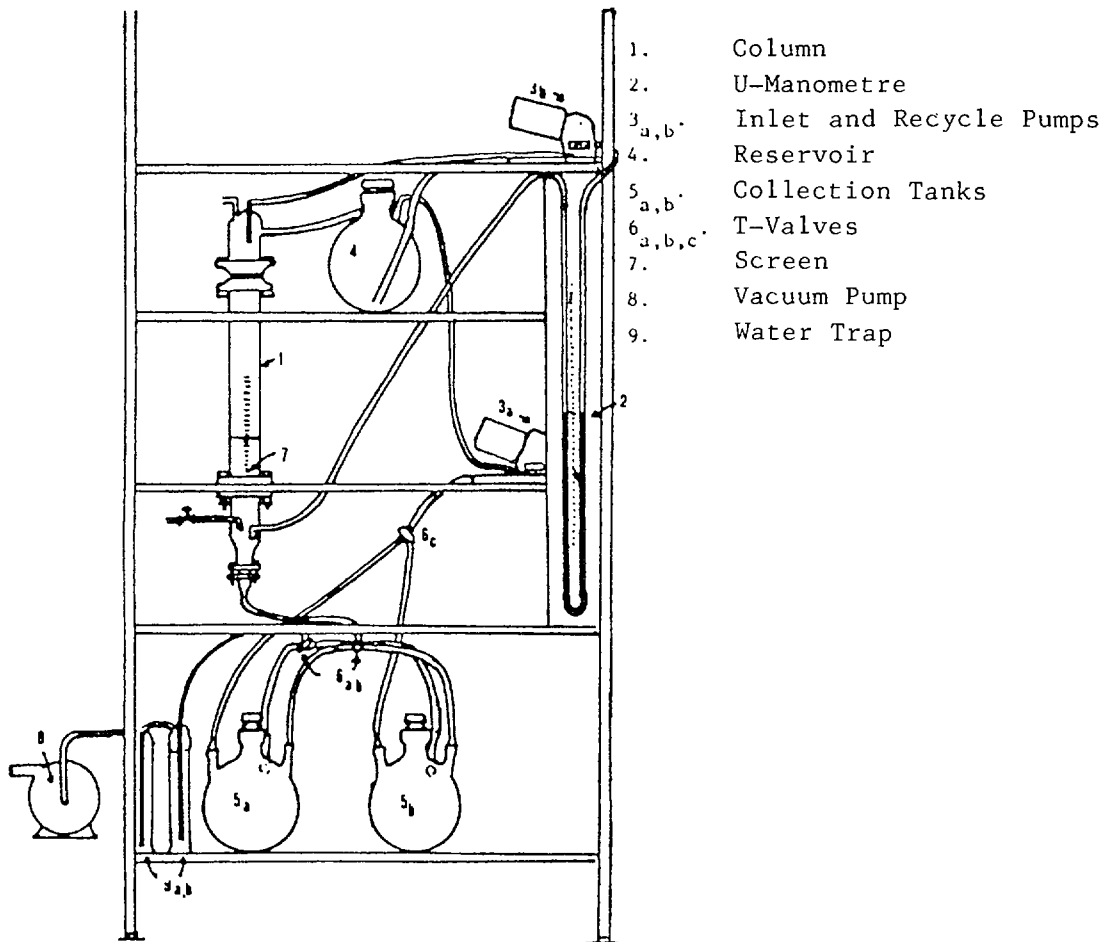

Figure 2 - Schematic Diagram of Column Leaching Apparatus

4. RESULTS AND DISCUSSION

Ore Characteristics

XRD examinations showed that the main minerals were SiO_2 , Al_2O_3 and CaCO_3 and small amount of complex silicates such as potassium alumina silicate was possible. No specific uranium mineral was detected on the blended uranium ore sample.

The blended ore grade was measured as 1330 ppm U_3O_8 . The chemical analysis for other key components of the ore sample were shown in Table 4. It is seen from Table 4 that the results of XRD examinations and the results of wet chemical analysis are in good convenience. MTA people observed similar results with ours. They reported that type of uranium mineral in the ore samples is not definitely determined, the technological behavior of the ore samples shows that uranium formation in the ore body could exist as oxide, sulfate or carbonate compounds (3,4,5).

Table 4- Chemical Analysis of The Blended Ore Sample of Yozgat-Sorgun-Temrezli Uranium Deposit

<u>Component</u>	<u>Wt, %</u>
U_3O_8	0.133
CO_2	2.732
SiO_2	72.230
Al_2O_3	11.700
Fe_2O_3	2.300
CaO	6.750
MgO	1.010
Na_2O	0.040
K_2O	0.023
SO_3	0.600
Total :	<u>97.518</u>

Batch Tests with Acids

As an initial study, two acid leach tests were conducted with solutions of 0.1 M HNO_3 and 0.1 M H_2SO_4 . Results of these two leaching experiments are shown in Table 5. Since nitric acid serves as its own oxidizer it is

Table 5- Results of Batch Leaching Experiments For HNO_3 and H_2SO_4

Leach Time (Hrs)	0.1 M HNO_3		0.1 M H_2SO_4	
	U_3O_8 Recovery %	pH	U_3O_8 Recovery %	pH
0.033	0.342	1.16	0.286	1.08
0.250	0.409	1.34	0.370	2.57
0.500	0.462	-	0.378	-
1.000	0.528	-	0.387	-
2.000	0.632	-	0.315	-
3.000	0.641	1.40	0.274	4.20
4.000	0.676	-	0.232	-
5.000	0.709	1.50	0.225	5.00
6.000	0.734	-	0.205	-

Table 6- Effects of Oxidant On Uranium Recovery For Sulfuric Acid
Batch Leach Tests.

Leach Time (Hrs)	0.1M H_2SO_4 2 g/l MnO_2	0.1M H_2SO_4 2 g/l H_2O_2
	U_3O_8 Recovery %	U_3O_8 Recovery %
0.033	0.485	0.177
0.250	0.527	0.199
0.500	0.613	0.245
1.000	0.759	0.303
2.000	0.886	0.303
3.000	0.924	0.511
4.000	1.000	0.981
5.000	1.000	1.000
6.000	1.000	1.000

particularly sensitive to pH. At the beginning, pH of leachate solution was 1.16, end of fifth hours it rose to 1.5. Nitric acid system achieved 73% recovery in 6 hours. The sulphuric acid test was begun with solution at a pH of 1.08. The acid was initially rapidly consumed with the pH rising to 2.57 in first 15 minutes. pH was measured as 5 after 5 hour periods of leaching. The sulphuric acid system is sensitive to pH as opposed to the nitric acid system. As shown in Table 5, the rates of

extraction by sulphuric acid increase in the first hour and then decrease after that. A preliminary conclusion is that the nitric acid system is the better of two. To investigate the effects of oxidant in sulfuric acid leaching, two additional experiments were performed with MnO_2 and H_2O_2 . Table 6 shows that adding 2 g/l MnO_2 or H_2O_2 oxidant to the leaching media highly increased the uranium recovery 98% uranium recovery was obtained after four hour periods of leaching for 0.1 M H_2SO_4 - 2 g/l MnO_2 and 0.1 M H_2SO_4 - 2 g/l H_2O_2 lixiviant systems.

To summarize the results of acid leaching tests, percent of uranium recovery versus time were plotted in Figure 3. Results of this study, however, show that it is necessary to add oxidant to sulphuric acid solution.

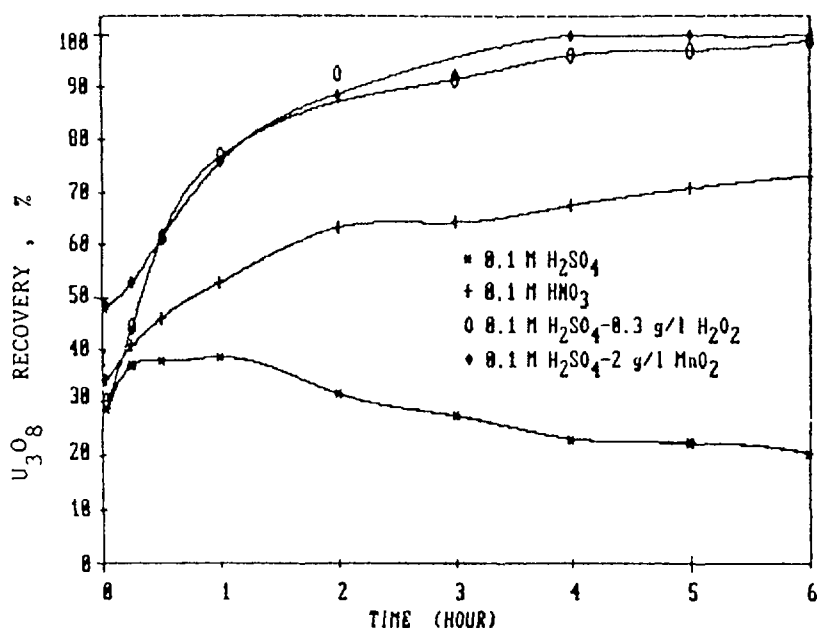

Figure 3- Comparison of U_3O_8 Recovery For Several Acid Leach Tests

Batch Test with Alkaline

Similar experiments were repeated with carbonate solutions. At the beginning, three reaching tests were conducted with Na_2CO_3 - NaHCO_3 , K_2CO_3 - KHCO_3 and $(\text{NH}_4)_2\text{CO}_3$ - NH_4HCO_3 lixiviant systems. Later, hydrogen peroxide was added to carbonate solutions. The experiments performed, showed that rates of extraction by carbonate solution without oxidant ore very low, addition of hydrogen peroxide to the extraction solution always increased the yield of uranium. The better result was obtained with sodium carbonate solution (Table 7).

Table 7- Results of Batch Leaching Experiments For Carbonate Solutions

Lixiviant System	0.1 M Na_2CO_3	0.1M K_2CO_3	0.1M $(\text{NH}_4)_2\text{CO}_3$
	0.1 M NaHCO_3	0.1M KHCO_3	0.1M $\text{NH}_4 \text{HCO}_3$
	0.6 g/l H_2O_2	0.6 g/l H_2O_2	0.6 g/l H_2O_2
Leach Time (Hrs)	Uranium Recovery , %		
0.033	0.167	0.111	0.062
0.250	0.227	0.130	0.069
0.500	0.232	0.163	0.080
1.000	0.270	0.187	0.110
2.000	2.272	0.216	0.121
3.000	0.321	0.260	0.152
4.000	0.330	0.267	0.154
5.000	0.340	0.279	0.159
6.000	0.335	0.277	0.158

To evaluate the effect of the total concentrations of carbonate and bicarbonate on the dissolution of uranium, a series of tests was run with Na_2CO_3 - NaHCO_3 - H_2O_2 system (Figure 4). As seen from Figure 4 the best uranium recovery was obtained with containing total 0.1 M carbonate concentration of sodium system. Additional three leaching experiments were carried out in order to investigate the effect of pH on dissolution of uranium during

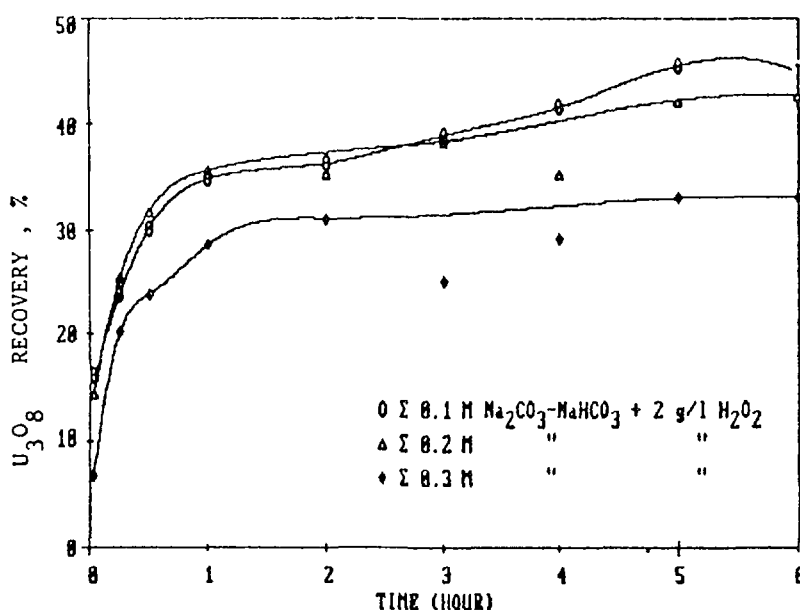

Figure 4- Effect of Total Carbonate Concentration On Uranium Recovery For Sodium System

sodium carbonate extraction. Total carbonate concentration was maintained constant as 0.1 M during these tests (Table 8). Results showed that the optimum concentrations of CO_3^{2-} and HCO_3^- are 0.085 M and 0.015 M respectively, 57% recovery was obtained after six hour periods of leaching.

Table 8- Effects of Carbonate and Bicarbonate Concentration On Uranium Recovery For Sodium Lixiviant System

Na_2CO_3	0.03 M	0.05 M	0.085 M
NaHCO_3	0.07 M	0.05 M	0.015 M
H_2O_2	2 g/l	2 g/l	2 g/l
pH	9.51	9.88	10.53
Leach Time (Hrs)	Uranium Recovery , %		
0.033	0.161	0.172	0.142
0.250	0.238	0.220	0.142
0.500	0.302	0.255	0.222
1.000	0.347	0.340	0.269
2.000	0.362	0.426	0.414
3.000	0.389	0.428	0.482
4.000	0.416	0.421	0.506
5.000	0.455	0.478	0.508
6.000	0.449	0.500	0.563

Autoclave Tests:

As mentioned above the best lixiviant had been found as 0.1 M H_2SO_4 -0.3 g/l H_2O_2 and 0.085 M Na_2CO_3 -0.015 M NaHCO_3 - 2 g/l H_2O_2 . Autoclave tests were run with these two solutions. Comparisons of the results of autoclave and shaker tests for acid and alkaline systems were summarized in Table 9 and Table 10. As seen from these tables similar good results were obtained during autoclave experiments.

Column Pack Test

Pack tests provide a reasonable method of measuring ultimate U_3O_8 recovery in the laboratory. After placing the ore sample into glass column the porosity of the bed was measured as 42 pct. Two column pack tests giving representative recovery results with 0.1 M H_2SO_4 -0.3 g/l H_2O_2 and 0.085 M Na_2CO_3 -0.015 M NaHCO_3 - 2 g/l H_2O_2 solutions are shown in Figures 5 and 6. The solution was circulated through the ore at a constant

Table 9- Comparison of Results of Batch and Autoclave Leach Experiments
For 0.1 M H₂SO₄ - 0.3 g/l H₂O₂ Solution

Leach Time (Hrs)	Autoclave Test (U ₃ O ₈ , %)	Batch Test (U ₃ O ₈ , %)
0.25	0.402	0.444
0.50	0.530	0.613
1.00	0.816	0.768
2.00	0.886	0.924
3.00	0.924	0.915
4.00	0.934	0.962
5.00	0.971	0.971
6.00	0.962	0.990

Table 10- Comparison of Results of Batch and Autoclave Leach Experiments
For 0.085 M Na₂CO₃-0.015 NaHCO₃- 2 g/l H₂O₂ Solution

Leach Time (Hrs)	Autoclave (U ₃ O ₈ , %)	Batch Test (U ₃ O ₈ , %)
0.25	0.181	0.142
0.50	0.211	0.222
1.00	0.279	0.269
2.00	0.371	0.414
3.00	0.480	0.482
4.00	0.488	0.506
5.00	0.499	0.508
6.00	0.526	0.563

flowrate (~0.5 l/hr) for 18 hours for sulphuric acid system, 30 hours for sodium carbonate system respectively. Figure 5 shows that very good results were obtained during acid column test, uranium recovery was more than 95%. Although batch leach test was more stable for sodium carbonate system, similar recovery (57%) was observed during column pack test. The problem encountered during column pack leach test with sodium carbonate was the ore swelling resulting in decreased permeability. Pregnant solution also was not clear for the sodium carbonate leaching.

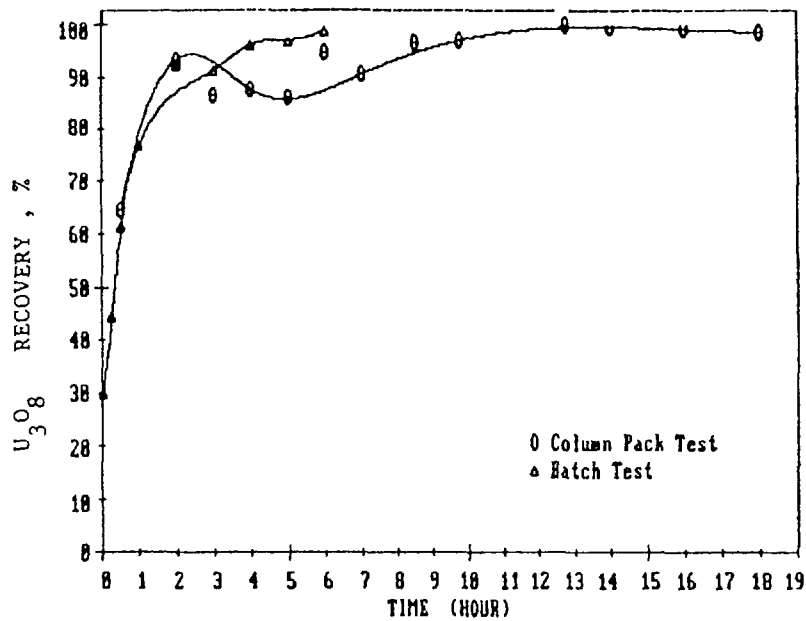

Figure 5- Comparison of U_3O_8 Recovery For Column Pack and Batch Leach Test ($0.1 \text{ M H}_2\text{SO}_4$ - $0.3 \text{ g/l H}_2\text{O}$)

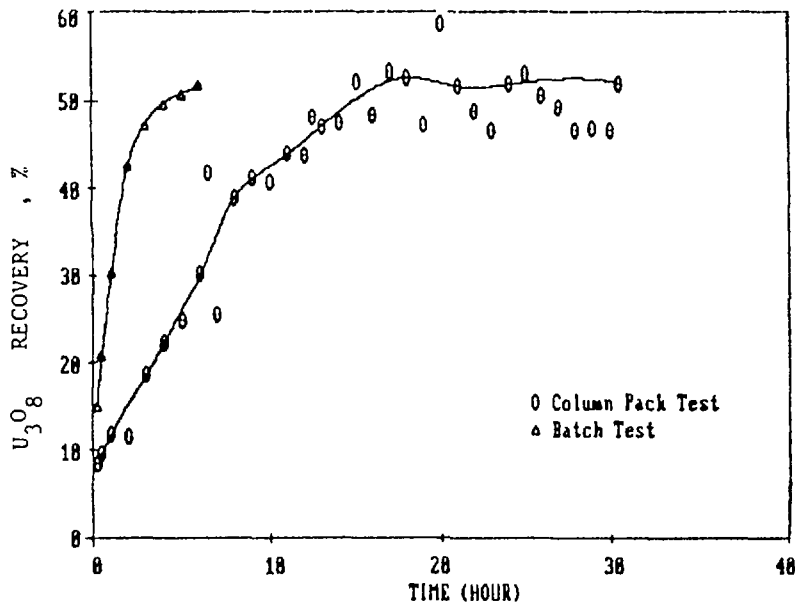

Figure 6- Comparison of U_3O_8 Recovery For Column Pack and Batch Leach Test ($0.085 \text{ M Na}_2\text{CO}_3$ - 0.015 NaHCO_3 - $2 \text{ g/l H}_2\text{O}_2$)

5. CONCLUSIONS

On the basis of the mineralogy and laboratory leaching performance of the blended sample representing Yozgat-Sorgun-Temrezli uranium deposit, the following conclusions can be reached.

- a. The main minerals are SiO_2 , Al_2O_3 and CaCO_3 . No specific uranium mineral was detected on the blended uranium ore sample.

- b. Batch and autoclave leach tests indicate that 0.1 M H_2SO_4 -0.3 g/l H_2O_2 is the most desirable leachate for extracting this ore. Addition of H_2O_2 or MnO_2 as an oxidant to the sulfuric acid solution always increases the dissolution of uranium.
- c. Batch and autoclave leach tests proved that the best alkaline lixiviant for the Yozgat-Sorgun blended ore sample is 0.085 M Na_2CO_3 -0.015 M $NaHCO_3$ -2 g/l H_2O_2 .
- d. Column pack leach tests confirmed that U_3O_8 could be leached rapidly and to high recoveries (>95%) using H_2SO_4 - H_2O_2 solution. Similar results observed with the results of batch tests during alkaline column leaching.
- e. Preliminary laboratory leach tests proved the applicability of in situ uranium leaching process for Yozgat-Sorgun-Temrezli uranium deposit.
- f. It is further proposed that additional column pack leach tests on a sample that is representative of the high grade portion of the area would be helpful in proceeding to the next phase of process design.

ACKNOWLEDGEMENTS

This work made possible by a research grant from Turkish Atomic Energy (TAEK-Research Project No.84300801). The authors wish to express their appreciation to the Management of TAEK for its support and permission to publish this paper. Special thanks to Management of MTA and Technology Laboratories for sending uranium ore and Mrs.Füsün Akdoğan for typing.

REFERENCES

1. OECD Nuclear Energy Agency and International Atomic Energy Agency, Uranium Resources, Production and Demand, Paris 1979.
2. Türkiye'nin Radyoaktif Mineralleri Hakkında Rapor, Arama-Potansiyel ve Teknolojinin Dünü Bugünü ve Geleceği, MTA, Ankara, Temmuz 1984.
3. Atalay, Y., Sağlam, R., Sungur, C., Yozgat-Sorgun(Temrezli-Akoluk) Uranyum Sahasının Rezerv Sondajlarının Değerlendirilmesi, MTA Enerji Hammaddeleri Etüd ve Arama Daire Başkanlığı, 1984.
4. Sağdık, U., Yozgat-Sorgun-Temrezli Uranyum Cevherinin Laboratuvar Çapta Teknolojik Deneyleri, Rapor-I-, MTA Teknoloji Dairesi, Ankara Mayıs 1983.

5. Sađlık, U., Yozgat-Sorgun-Temrezli Uranyum Cevherinin Laboratuvar apta Teknolojik Deneylei, Rapor-II-III- MTA Teknoloji Dairesi, Ankara Mart 1986.
6. Johnson, D.A., and Florence, T.M., Spectrophotometric Determination of Uranium (U) with 2(5-Bromo-2-Pyridylazo)-5-Diethylaminopheno) Anal, Chim.Acta, 53(1971), 73-79.

IN SITU LEACHING OF URANIUM IN THE USSR

J.I. SKOROVAROV, R.H. SADYKOV, V.D. NOSOV
All-Union Scientific Research Institute
of Chemical Technology,
USSR State Committee on the Utilization
of Atomic Energy,
Moscow, Union of Soviet Socialist Republics

Abstract

The paper describes the utilization of in-situ technology for exploitation of some uranium ores in the USSR. The geological requirements of the orebody and the ore content in uranium are described.

The characteristics of well fields and the form of doing the leaching are described considering the advantages and inconvenients of acid and bi-carbonate methods of leaching.

In order to decide the method of uranium mining an index is defined considering the difference between commercial reserves and uranium extracted.

The underground leaching of uranium has acquired an extended application in the USSR, the initial studies being commenced in the early 1960s (1,2).

The method is being used now for the working of the uranium deposits with low-grade ores and with complicated geological-hydrogeological conditions, where the traditional methods of mining appear unprofitable (due to aquifer conditions, multi-layer nature of the ore body, tectonic deformations, etc.).

The method under consideration has speedily undergone all the stages of research, design and commercial implementation in the exogenetic deposits, built up by loose, water permeable depositions.

The in-situ leach mining is applied, as a rule, to the common low-grade ores with the uranium contents 0.03-0.05%; the uranium mineralization there is represented by oxides and coffinite. The ore composition is feldspar quartz and aluminosilicate, often mixed with (5-10%) kaolinite, montmorillonite and hydromica. The ores are usually slightly carbonate (up to 0.5-3.0%) less - me-

dium carbonate (up to 2%), the contents of organic materials is not high - 0.1-0.5%. silphides - 0.1-0.2% (at times 0.5-1.0%). The host rock horizons are mainly boarered by clay water confining layers along the roof and base, the depositions have the form of rolls. When the thickness of the productive horizons is great (20 m) multibedded depositions often form. The thickness of the ore bodies is from 1-2 to 10 m and over, the depth of the deposition is from 30-50 to 500-700 m. The underground waters of the ore-bearing horizon are usually under pressure; the main mineralization components are ions of calcium, magnesium, sodium, bicarbonate, sulphate and chloride.

The in-situ leaching method can be applied under specific geological-hydrogeological conditions only. The most important are aquifer of the deposit, permeability of the ore body and the possibility to transfer the uranium from the solid phase into the solution using standard solvents and oxidants.

On the initial stage of the underground leaching development in the USSR the method was used for the deposits with comparatively simple geological-hydrogeological conditions: shallow deposition (up to 200 m), favourable geotechnological ore and host rock properties (carbonate contents up to 0.5-1.0%, clay contents up to 5-10%, water permeability 1-5 m/day). As an example of such deposit an occurrence of tabular type, as described in ref.(3) is taken. It belongs to the sedimental Mesozoic rocks, deposited on the crystal base of the Paleozoic. The host rock horizon is in the Higher Turonian sediments, presented by a packet of alluvial gravellites, sand stones and clay-cemented sands with layers of clays and aleurites. The horizon is 15-20 m thick, rather uniform and runs for considerable distance. The deposit has six water confining horizons; to be mined is the third one superposed with the orebearing horizon; its piezometric level is 20-50 m removed from the surface under the natural conditions. The mean value of the filtration coefficient is about 0.5 m/day, the uranium contents - 0.05%.

The deposits in the USSR are generally mined by a linear system of technological wells, there are only separate cases of grid-like spacing system (4). The choice of well spacing depends on numerous natural and technological factors, technical resources of the facilities and well maintenance, process economics, etc. The home wellfields for the in-situ leach technique have

grid-like spacing sized from 10 x 10 m, 10 x 20 m to 25 x 50 m, 10 x 100 m, differing from the site in the USA with square side 15, rarely 30 m. For the working of the deposits with small injection capacity the rows of the injection wells are denser.

The cost of a well depends on the depth of ore deposition, rock strength, well diameter, material of casing pipes, equipment used for drilling, etc. The drilling takes up from 15 to 25-30% of a site production cost (4).

Injection wells are usually drilled up to 90-161 mm in diameter; the diameter of the recovery wells usually equals that of the injection ones. At a shallow deposition (up to 150 m) the wells are cased with polyethylene pipings 10-12 mm thick. At greater depths pipes 18 mm thick are used. In this regard and considering the increased injection capacity of the injection wells and the flow rate of the recovery wells a tendency appears to increase the diameter of drilled production wells (up to 295-394 mm). In this case submerged pumps 143 mm are applied for removing solutions. Filters are installed within the limits of the ore zone (5).

The leaching indices, as in a hydrometallurgical process, are determined by the same data as those of the traditional technology: the volume of the solution in relation to the mass of the rock processed, or the number of the pore volumes passed through the host rock horizon, the specific reagent consumption per unit of rock mass and 1 kg of the uranium recovered, by the recovery degree from geological reserves or the reserves in the permeable rocks (6).

The practical application of the in-situ leaching in the USSR concerns both acid and carbonate-bicarbonate solvents. Still, the basic mining technique in the USSR is the leaching scheme with sulphuric acid. This technology has been presently developed well enough. The extensive use of sulphuric acid scheme, as compared to the alkaline one, omnipresent in the USA, is conditioned by a more favourable chemical composition of the home ores to be leached (mainly, by the low contents of carbonates in most commercial deposits).

With increasing acid concentration in the leaching solutions the mean uranium contents in the productive solutions rise and the process duration decreases. However the acid consumption per unit of ore bearing rock mass grows. On the other hand, the leaching solution is to have such initial concentration of sulphu-

ric acid, that the production solution from the recovery wells would possess excessive acidity of 2-5 g/l.

The home in-situ leaching technique, regarding specific conditions on the site, uses the following regimes: feeding low concentrations of acid - 2-5 g/l within the whole leaching stage; differentiated - when different stages call for different acid concentrations. The choice of the mining regime and optimal acid concentration for leaching is made on the basis of laboratory tests data, taking into account such factors as acid capacity of the rock, rate of interaction, recovery of the useful component into the solution, yield of the production solution per unit of the rock-ore mass, economics of the process, etc.

The highly aggressive character of the acid affects its raised consumption; its specific consumption per ton of the rock-ore mass is from 5-6 to 10-15 kg. The mean value of the acid consumption per 1 kg of the uranium extracted in the end product varies from 80-100 up to 120-150 kg (4).

The carbonate-bicarbonate leaching in the USSR is used for treating ores with raised contents of acid-capacitant components (e.g. over 1.5-2.5% carbonates). The effectiveness of this method of transferring uranium into the solution is determined by the nature of the solvents (and oxidants) employed and the ability to optimize the process. Discriminative choice of these factors with an account for technological, economic and environmental circumstances can provide successful operation of the mine.

In practice ammonium bicarbonate solutions (from 0.5 to 3-5 g/l) are used as solvents. In single cases it is possible to use solutions of sodium bicarbonate. Ammonium bicarbonate is known to maintain permeability of the rock, but consequent restoration of the underground water composition is troublesome. Disadvantage of sodium bicarbonate is its ability to cause swelling of the clay materials and impair permeability, but restoration of the natural composition of the water-bearing horizon is not costly.

Air or technical oxygen is used as oxidant at the carbonate in-situ leaching in the USSR. The advantage of oxygen is its low cost, the constrains - necessity to introduce it into the mine dissolved (under normal conditions its solubility is small) and a chance of gas plugs forming when the pressure in the layer changes.

The hydraulic pressure on the roof of the host ore horizon is important: with small pressure you cannot attain a proper oxygen

concentration in the solutions. The laboratory tests have determined a possibility to gain good results at the carbonate leaching of the most ores tested using stronger oxidants (hypochlorites, permanganates), as compared to the leaching by sulphuric acid. However, at the carbonate leaching with oxygen, used as an oxidant, decreases the rate of uranium transition into the solution; the number of the pore volumes, passing by, increases and the recovery rate drops (from 3-5% to 10-15%).

The process under consideration favours the ores in which the uranium mineralization is represented mainly by oxides and fine fractions of coffinite. The other favourable conditions are low contents of sulphides, dissolution of which affects oxidant consumption, formation of sulphate-ion and products of incomplete oxidation - tiosulphate and polytionates as well as organic material, clay minerals, etc.

It is important to maintain a certain ratio of the bicarbonate-ion and oxygen during the carbonate in-situ leaching, which should correlate with the ore components consuming oxidant and solvent.

The merits of the carbonate in-situ leaching consist in the possibility conducting it in the neutral and weakly alkaline media, using less expensive equipment, attainability of proper composition for the underground water after the treatment and the high production rates on the subsequent sorption stage due to the low salt contents in the recirculating solutions.

The selective ability of the carbonate solvents brings forth low consumption coefficients; they comprise 0.5-3 kg of solvent and 0.5-1 kg of oxidant per 1 ton of the rock.

Multiformity of possible schemes for the carbonate leaching predetermines the necessity for a still more detailed investigation of the initial material.

In accordance to the adopted in the USSR methodology for the laboratory studies all the samples are to be tested on both acid and carbonate leaching schemes. The final choice of the solvent is conditioned by the uranium content in the ore, consumption coefficients, recovery degree, economics of the process, etc.

An important index for the uranium mining method via in-situ leaching is the value of the metal recovery degree. The value is determined by calculation of the difference between the commercial reserves and the uranium extracted. Accordingly, it is

worth-while to consider the separate constituents of the uranium losses underground. Based on the commercial operation experience we have singled out the following items in the losses:

1. The losses due to incomplete transition of uranium from the ore into the solution at given solvents, oxidants and leaching conditions. This value is determined by the part of hard-soluble uranium mineralization under given conditions and the part that remains unleached in the zones of decelerated solutions circulation. It is assessed to be 5-10% for acid leaching and 10-20% for carbonate leaching.

2. The losses determined by the part of the reserves belonging to practically impermeable or weakly permeable rocks: clays, loams, heavy sand loams, etc. The fraction of the uranium reserves in these rocks can considerably vary from 5-10% to 40-50%. There have been two cases of uranium deposition in a thick layer of clay: in the first case uranium occupied the medium part of the host rock, in the second - the outer surface, forming an ore layer from 5-10 to 50-100 cm thick. It is evident that the uranium extraction degree from the ores under consideration at the similar operational conditions will differ. Beside the losses at leaching this item is one of the most serious.

3. The losses due to re-adsorption of the dissolved uranium by the water-confining layers in the roof and base and along the outline of the layer to be leached. The value of these losses is affected by the total surface of the contact between the host and barren rocks capable of adsorption, the direction of the uranium-bearing solution filtration, their composition, duration of the contact. Subsequently, due to the diffusive back-leaching, the adsorbed uranium is re-extracted into the filtering flow; however, the recovery kinetics is lower than the adsorption rate. The uranium losses due to the adsorption with the account of the diffusive back-leaching can be assessed as 4-8%.

4. The losses due to incomplete washing of the solution underground and its transportation to the surface; it is known that various mines set up their own value for the lowest commercial uranium contents in the production solutions, still smaller values make the production unprofitable. The scale of these losses is determined by the ratio of capacities and filtration coefficients for ore-bearing and barren rocks, the system and pattern of the wells arrangement, the uranium contents in the ores, etc.

At a considerable dilution of the solutions underground the commercial minimum can be attained with the high enough uranium concentrations in the pore ore solution. As assessed these losses comprise about 4-6%.

5. The losses due to the solutions leakage beyond the circuit. The losses are not great, provided that the indices on the sorption are satisfactory and the production area is compact. The losses owing to leakage can be approximating as 2-4%.

6. The losses due to incomplete uranium recovery on the sorption stage. The losses result from withdrawal of the solutions with negligible uranium contents out of the technological scheme. They are evaluated 1-3%.

Depending on separate constituents the value of the uranium recovery varies within a wide range. Thus, assuming the reserves in the impermeable ores to be 5-10%, the recovery will reach 65-80% at the sulphuric acid leaching and 55-75% at the carbonate leaching.

The recovery degree on the in-situ leaching sites is lower than that at the processing in a hydrometallurgical plant (for 15-20%). Still, taking into consideration the uranium losses at mining and the additional uranium amount extracted from low-grade ($\geq 0.01 < 0.03\%$) and poor ($< 0.01\%$) ores the total recovery equals and at times can exceed its level when using the traditional mining method with subsequent hydrometallurgical treatment (7).

The methods for uranium extraction from the production solutions at the in-situ leaching in the mine yards are the same in the USSR and abroad. The specific indices and parameters of the process on different plants may vary due to diversity of mineral composition of the host rocks, conditions of the in-situ leaching process as such, and physical-chemical peculiarities of the sorbent used.

As a rule the technological solutions after the sulphuric acid leaching have the following composition, g/l:

Al^{3+} 0.5-0.8; Fe^{3+} 0.8-1.5; Fe^{2+} 0.4-1.0; Ca^{2+} 0.4-0.6; Mg^{2+} 0.3-0.5; $Na^+ + K^+$ 0.1-0.2; SO_4^{2-} 17-25; Cl^- 0.4-0.6; Ra $n \cdot 10^{-10}$ curie/l.

The technological solutions after the carbonate-bicarbonate leaching approximate the following composition, g/l:

Ca^{2+} 0.7-0.8; Mg^{2+} 0.1-0.3; SO_4^{2-} 2.0-3.0; NH_4^+ 0.4-0.6; HCO_3^- 0.5-2.5; Cl^- 0.5-1.2; $Na^+ + K^+$ 0.5-1.0.

The working of the in-situ leaching deposits as compared to the traditional mining methods considerably lessens the damage to the environment. Nevertheless, it is necessary to take into account the soil contamination (especially at the acid process). To prevent this the soil is usually removed along the all length of the technological wells row for 4-5 m wide and 40-50 cm deep prior to the exploitation commencement. The soil is replaced after the reserves on the site have been exhausted. In some cases the operation is limited to removing the layer of the soil around the technological wells only (4).

The possible schemes for the underground waters treatment after the acid leaching are the traditional methods of neutralizing waters on the surface aimed at separation of the heavy metals residuals with consequent electroosmosis or their filtration through the intact horizons, containing rocks easily reactable with acid (carbonates).

A most simple and accessible scheme for water treatment after the carbonate leaching is the scheme for subterranean flushing with partial desalination of the contaminated solutions via electroosmosis.

Experience in the in-situ leaching uranium mining in the USSR reveals the advantages and constrains of the acid and carbonate in-situ methods for uranium recovery.

The acid solvent ensures uranium extraction from permeable rocks for 70-75% degree, and at favourable conditions (filtrational homogeneity) - up to 80-85%;

- it has good interaction kinetics, which leads to higher uranium concentrations in the production solutions and lower solution consumption per unit of host rock;
- it reacts vigorously with a great number of rock components, which brings forth, on the one hand, transition of a considerable amount of impurities into the solution, which affect the subsequent stages, on the other hand - its raised consumption per unit of the end product;
- it develops, especially when carbonates are present in the rock, gaseous and gypseous colmatations, which degree is determined by geological-hydrogeological deposit conditions and the adopted mining parameters. The development of the gypseous colmatation can be especially considerable: the disbalance of the sulphate-ion, introduced under the ground in the pore solutions, can reach 30-50%.

The use of an acid solvent impairs the restoration of the underground waters composition due to high salt contents, the remainder of the acid has to be neutralized.

The carbonate solvent as compared to the acid one:

- has high selectivity; uranium is leached together with a small amount of accompanying elements; the consumption of solvent and oxidant is cut 5-10 times;

- it requires an oxidant for all cases of transition metal into solution; the most available and cheap oxidant, used in the underground leaching in the USSR to date is oxygen;

- it ensures 65-70% uranium recovery from permeable rocks, which is 5-15% less when using an acid solvent;

- it vigorously interacts with sulphides, sometimes forming products of their incomplete oxidation - tiosulphate, polythionates, impairing the following sorption process.

The development and implementation of the in-situ leaching process for uranium mining is an important achievement of the mining industry. The experience accumulated in mining proves perspectiveness of the method beyond any doubt. The method is liable to further improvement and the work done is only an initial step to it. The development of the method will call for better cumulative knowledge of the deposits to be worked, deeper investigation of the processes underground and metal recovery, perfection of technology and production equipment at the in-situ leaching.

REFERENCES

1. Зефирова А.П. Доклад СССР на Международном симпозиуме по переработке бедных урановых руд. Р -014, Вена, МАГАТЭ, 1966

2. Зефирова А.П., Невский Б.В., Бахуров В.Г., Луценко И.К. Подземное выщелачивание урановых руд. В кн.: "Труды IV Международной конференции ООН по мирному использованию атомной энергии" (Женева), № 40/p/45; IAEA, 1972, т. 8.

3. Губкин Н.В., Десятников Д.Т., Руднева И.К. Преимущество применения метода подземного выщелачивания урана в условиях обводненных пластовых месторождений. "Атомная энергия", т.24, вып. 6, с. 511-514, 1968.

4. Добыча урана методом подземного выщелачивания. Под ред. Мамилова В.А., Атомиздат, М., 1980.

5. Сергеенко И.А., Мосев А.Ф. и др. Бурение и оборудование геотехнологических скважин. Недра, М., 1984.

6. Бахуров В.Г., Вечеркин С.Г., Луценко И.К. Подземное выщелачивание урановых руд. Атомиздат, М., 1969.

POTENTIALITIES OF PERCOLATION LEACHING OF URANIFEROUS SILTSTONE FROM WADI-NASIB, EGYPT

M.A. MAHDY
Nuclear Materials Corporation,
Cairo, Egypt

Abstract

An uraniferous sedimentary formation has lately been discovered in Wadi Nasib area, west central Sinai, Egypt. The formation belongs to the lower Carboniferous, and involves various facies namely; siltstone, shale, sandstone and gravel. Mineralogically the siltstone facies is composed of kaolinite 60%, montmorillonite 10%, quartz 15% and iron oxides range from 10-15%, while the economic minerals are represented mainly by atacamite Cu_2ClOH_3 and K-rich zippeite $2\text{UO}_3 \cdot \text{SO}_3 \cdot 5\text{H}_2\text{O}$. and meta-autonite $\text{Ca}(\text{PO}_4)_2 \cdot 8\text{H}_2\text{O}$.

A series of agitation leaching experiments were performed on a laboratory scale using different mineral acids and the obtained results indicated almost complete leaching of both uranium and copper. However, by alkaline leaching using sodium carbonate and/or sodium bicarbonate, it was possible to dissolve uranium almost selectively leaving copper in an insoluble form.

Indeed, the low grade nature of the ore material and its amenability to leaching under mild conditions inferred the application of in-situ leaching. The latter is largely preferable due to various environmental, economical and technical aspects. Therefore, a number of percolation leaching experiments using water as well as acid and alkaline solutions were performed to study the different relevant factors. Preliminary data indicated encouraging results and the various achieved laboratory tests would be used to plan for a pilot plant study.

1. INTRODUCTION

Several uranium anomalies have been found in various sedimentary rock facies occurring in wadi-Nasib area, west central Sinai [1].

These uraniferous facies include siltstone, shale, ferruginous sandstone and gravel and belong to a dolomitic limestone series. This series is underlain by a non-fossiliferous sandstone series and overlain by fossiliferous sandstone series [2]. The whole formation belongs to lower Carboniferous age and lies unconformably over the Cambrian Nubian sandstone. Some uraniferous anomalies are associated with other metalliferous mineralization, namely copper and/or manganese.

Due to the sedimentary nature of the ore material under study and its mineralogical composition, it appears that in situ leaching would prove suitable for treating such an ore material. Besides, in situ leaching has proven quite successful in the recovery of low grade ore materials in a manner to substantially reduce production cost [3-6]. Moreover, in situ leaching would meet the recent environmental concerns over the conventional mining and milling techniques.

Therefore, the present paper would be concerned with studying the potentialities of uranium and copper recovery from a selected siltstone sample through the application of in situ leaching. To realize this objective, a series of leaching experiments have been performed on this ore material using the percolation leaching technique. A number of agitation leaching experiments have also been carried out for the sake of comparison.

2. MINERALOGICAL AND CHEMICAL COMPOSITION OF THE ORE MATERIAL

The selected ore material siltstone sample assays 3180 ppm U and 1690 ppm Cu. Mineralogically, the sample was found to be essentially composed of the clay minerals kaolinite 60% and montmorillonite 10% beside quartz 15% while iron oxides range from 10-15% and gypsum may be found in amounts not exceeding 5%.

The economic minerals have been identified in a previous work [7]. Thus uranium is mainly represented by secondary minerals including K-rich zippeite, meta-autonite and torbernite while carnotite, meta-tyuyamunite and meta-zeunerite are found in lesser amounts. On the other hand, copper is also represented by the secondary mineral atacamite beside trace amounts of malachite.

Chemical analysis of the selected siltstone sample gave the composition shown in Table (1).

TABLE (1). AVERAGE CHEMICAL COMPOSITION OF WADI-NASIB URANIFEROUS SILTSTONE

Component	Wt %
SiO ₂	52.00
Al ₂ O ₃	16.05
Fe ₂ O ₃	7.46
Na ₂ O	1.05
K ₂ O	4.97
CaO	4.04
MgO	4.65
Cl ⁻	0.72
SO ₄ ⁻⁻	3.23
H ₂ O ⁻	4.00
O.M. *	2.41
Total	100.58

* Organic matter calculated as ignition loss at 470°C.

3. EXPERIMENTAL

The agitation leaching experiments have been performed after some preliminary tests [8] in rounded-bottom, 500 ml flasks. The ore used was ground to - 100 mesh size and was allowed to be agitated in 1:2 solid/liquid ratio with no addition of oxidant.

On the other hand, the percolation leaching experiments were carried out using a set of 3 cm diameter glass columns and 300 gm samples of the ore material, ground to - 10 mesh, were packed in the columns to a height of about 35 cm. Water was allowed to pass through all the columns [9] for 10 days (about 600 ml) before the leaching solutions. The unrestricted water flow rate obtained was only about 2.5 ml /h which increased when passing the acid solutions and decreased by passing the carbonate solutions.

4. RESULTS AND DISCUSSION

The agitation leaching experiments were achieved utilizing various mineral acids in concentrations ranging from 50-300 g/l while using 4 hours agitation time at 90°C and without applying any oxidant (unless otherwise cited). The obtained leaching efficiencies are plotted in figs. (1-4) from which it is clear that sulphuric and nitric acids could not extract more than 55% and 60% of uranium respectively. However, almost complete leaching of

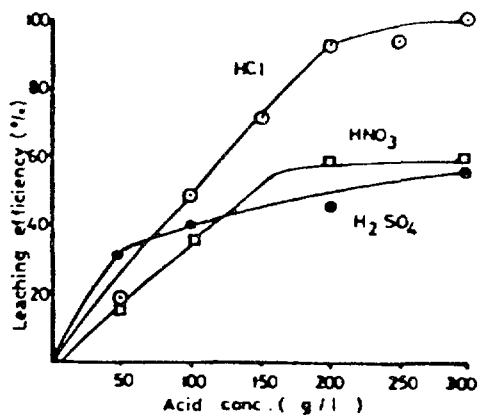

FIG.1. Effect of acid concentration on leaching efficiency of uranium.

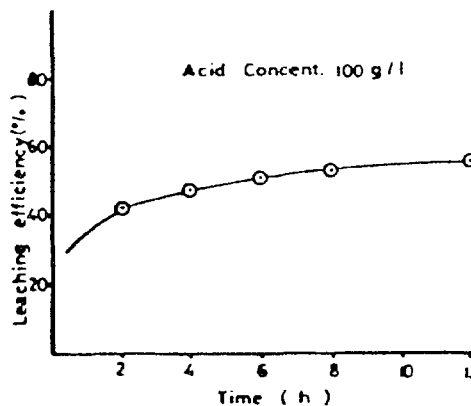

FIG.2. Effect of time on leaching efficiency of uranium using HCl acid.

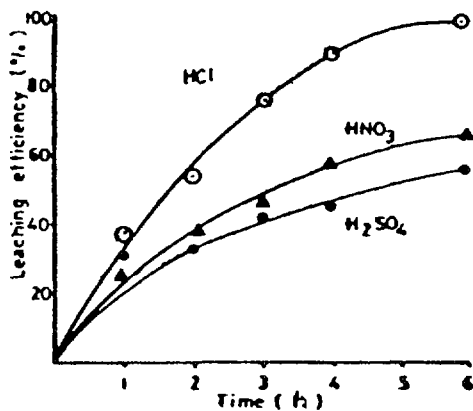

FIG.3. Effect of time on acid leaching of uranium.

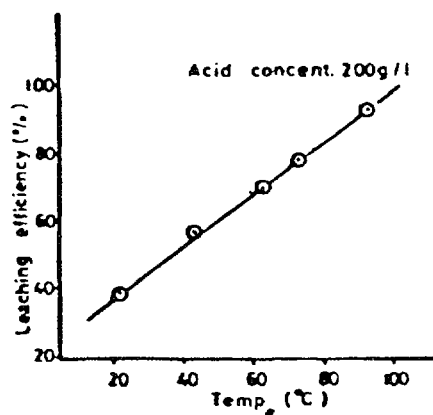

FIG.4. Effect of temperature on leaching efficiency of uranium using HCl acid.

uranium have been effectively attained by hydrochloric acid under similar leaching conditions. Prolongation of the duration time of agitation did not show any sound effect on uranium leaching efficiency. On the contrary leaching temperature proved effective on uranium extraction under the leaching conditions used. On the other hand, analysis of copper in the obtained acid leach liquors revealed that it is completely leached in both H_2SO_4 and HNO_3 acids while only about 40% copper leaching was obtained by HCl (Fig.5). These results are achieved at only 4-6 hours agitation time while extending the leaching time of HCl beyond 6 hours improved slightly the leaching efficiency of copper (Fig.6). Moreover, neither addition of oxidant nor rising the leaching temperature has any positive effect on copper leaching efficiencies.

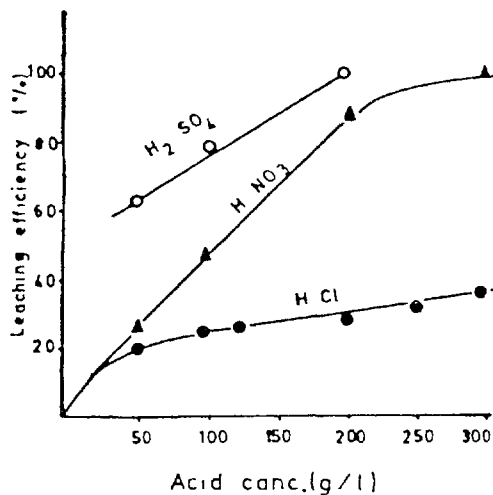

FIG.5. Effect of acid concentration on leaching efficiency of copper.

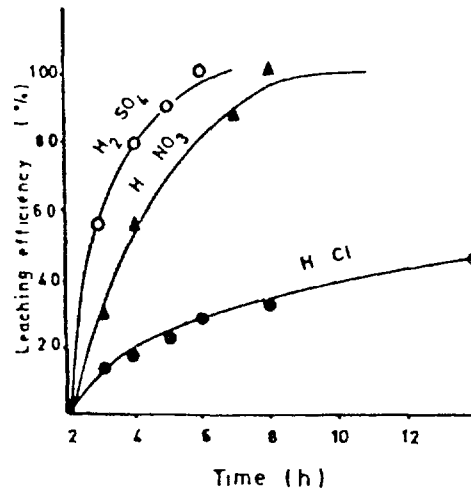

FIG.6. Effect of time on acid leaching of copper.

Another series of agitation leaching experiments were performed using Na_2CO_3 and in some cases $NaHCO_3$ was steadily used instead of the carbonate leaching solutions. Experimental conditions were fixed at $90^\circ C$ leaching temperature for 4 hours leaching time and using 50 g/l Na_2CO_3 without addition of any oxidant (unless otherwise cited). The obtained results are shown in Figs (7-10), and indicate that more than 80% uranium could be leached by 50 g/l Na_2CO_3 at $90^\circ C$ within 8-10 hours leaching time. Extending the leaching time beyond the latter, did not show any perceptible change in the leaching efficiency. It is also evident that addition of sodium chlorate as an oxidant is not effective in improving the leaching efficiency. The low leaching efficiencies obtained by replacing Na_2CO_3 by $NaHCO_3$ at comparable concentration could be interpreted as due to its decomposition at the leaching temperature used and in turn lower concentration of the resultant Na_2CO_3 . Alkaline leaching might prove advantageous in selectively leaching uranium leaving copper behind. More work is needed to decide upon simultaneous acid leaching of uranium and copper or selective leaching of either.

A percolation leaching experiment was afterwards performed using 10 /l HCl . Before passing the acid, the packed ore was washed with 600 ml water and the obtained solution gave a uranium concentration of 4 ppm. Passing water for 2 months resulted in a

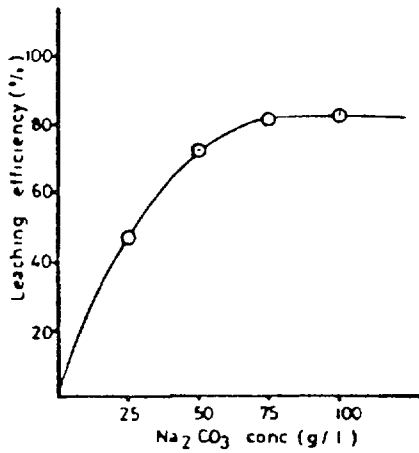

FIG.7. Effect of Na₂CO₃ concentration on leaching efficiency of uranium.

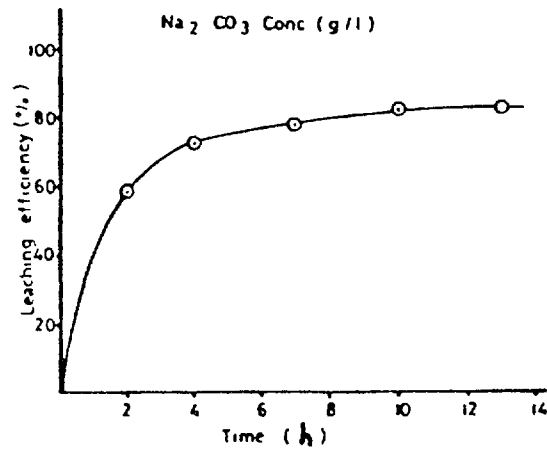

FIG.8. Effect of time on leaching efficiency of uranium.

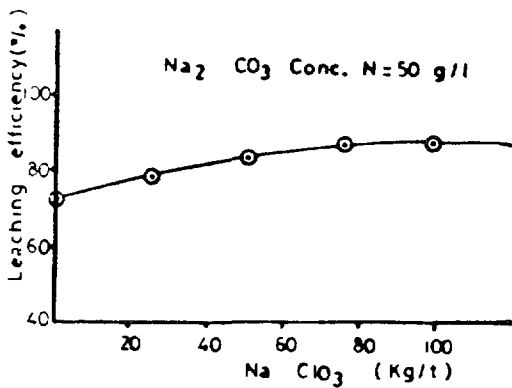

FIG.9. Effect of NaClO₃ on leaching efficiency of uranium.

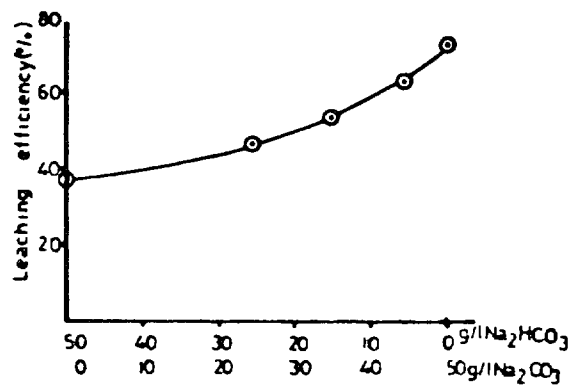

FIG.10. Effect of replacing Na₂CO₃ by NaHCO₃ on leaching efficiency of uranium.

fixed uranium concentration of 4 ppm too. The extremely low flow rate obtained (2.5 ml/h) is actually due to the very fine nature of the ore under study [3,5], in a manner that in spite of its high porosity, its permeability is quite poor. Passing the acid afterwards resulted however, in an increased flow rate (4.1 ml/h) which is equivalent to about 100 ml/day. The experiment was followed for about 2 months and the resultant leaching solution was sampled every 6 days for uranium analysis. The obtained results plotted in Fig.(11) indicate a steady increase in uranium leaching efficiency in the first 42 days. Thus uranium leaching efficiency increased from over 5% after 12 days to about 30% after 42 days. However, sharp increase in the uranium leaching efficiency has been achieved in the last 30 days from 30% to almost complete leaching. It might be interesting to mention that the acid was almost completely consumed in the first 2 weeks after which the pH decreased steadily until reaching about 1.4. This might interpret the precipitation of copper at high pH values. Also, it was ascertained that copper leaching was completed in about 30 days at only 15% uranium leaching.

Another percolation leaching experiment was carried out using only 1 g/l Na₂CO₃ after a prior water wash. Unfortunately, the obtained flow rate was impractical as it attained only 0.8 ml/h.

This might be due to precipitation of some salts in the ore bed. After 2 months uranium leaching efficiency did not exceed about 10-12% (Fig. 11). Indeed, more study is required to overcome the ore fineness whereby higher concentration of Na_2CO_3 and/or NaHNO_3 could be tested.

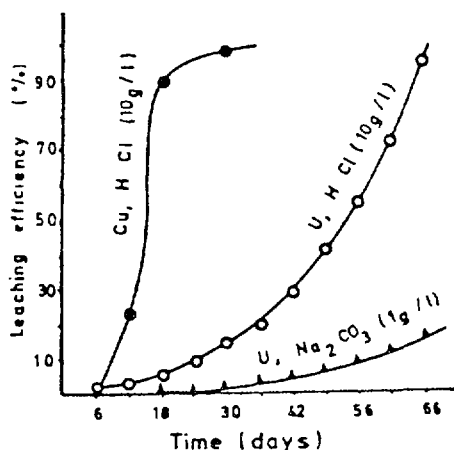

FIG.11. Effect of time on percolation leaching efficiency of uranium and copper.

The above mentioned preliminary experiments, indicate that percolation leaching as indicative of in situ leaching would prove feasible. Compared to agitation leaching, big save in recovery costs is largely expected. The main problem resides in the extreme fineness nature of the ore material under study. Future work would be oriented towards solving the problem of flow rate and applying for pilot plant stages.

R E F E R E N C E S

- [1] EL AASSY, I.E., et al, Prospection and proving of some radioactive occurrences in west central Sinai, Internal Rep., NMC, Cairo, (1986).
- [2] HUSSEIN, H.A., ANWAR, Y.M., EL SUKKARY, A.A., Radioactive studies of some Carboniferous rocks of west central Sinai, U.A.R., J. Geol., 15, 2, Cairo, (1971).
- [3] MASHBIR, D.S., Heap leaching of low grade uranium ore, Mining Cong. J., 12, U.S.A., (1964).
- [4] MARS, L.F., Underground leaching of uranium at the Pitch Mine, Mining Cong. J., 11, U.S.A. (1970).
- [5] APLAN, F.F., MCKINNEY, W.A., PERNICHELE, A.D., (Editors) Solution mining symposium (Proc. Symp. AIME; Texas), U.S.A., (1974).
- [6] DAVIS, G.R., MILLER, R.E., WSIFT, G.G., In situ leaching mining for uranium, IAEA-AG/33-15, Uranium ore processing (Proc. Advisory Gr. Meet., 1975), Vienna, (1976).
- [7] DABBOUR, G.M., MAHDY, M.A., Mineralogical studies on the lower uraniferous sediments of wadi nasib, Sinai, Egypt, C.N.S.A. Conf., Cairo, (1988).
- [8] MAHDY, M.A., DABBOUR, G.M., EL AASSY. I.E., Hydrochloric acid leaching of uraniferous siltstone of wadi nasib, Sinai, Egypt C.N.S.A. Conf. Cairo, (1988).
- [9] MERRITT, R.C., PATERSON. H.D., WENIZ, C.N., Heap leaching studies on uranium ore, USBM contract No. H0252022, Washington D.C., (1976).

PANEL DISCUSSIONS

PANEL 1

STATUS AND TRENDS OF THE TECHNOLOGY OF IN SITU LEACHING

Chairman: A.H. Montgomery (United States of America)

The purpose of this Panel was to review the most important aspects of the current technology of in-situ leaching, including geological aspects, modelling of aquifers, well-field design, well construction, leaching chemistry, aquifer restoration and waste disposal.

1. Geologic characteristics suitable for in-situ leaching

Certain specific geological characteristics are required for in-situ leaching. The orebody must be below the water table; the host rock must be sufficiently permeable to allow the circulation of leaching reagents; there must be confining impermeable layers above and below the mass of ore; the ore must be leachable by environmentally acceptable reagents and must be of sufficiently high-grade to make the operation economically feasible.

2. Modelling of aquifers

Hydrological models may be used for environmental control and to comply with the requirements imposed by regulatory bodies. Models must be updated and validated based on actual field experience. More realistic models can be made by superimposing chemical kinetics on hydrological models.

3. Well-field design

The design of the well-field must be adapted as closely as possible to the characteristics of the orebody, taking into account the distribution of uranium within the orebody and the available hydrological model or models. With this information it is possible to select the number and distribution of injection, production and monitoring wells and to establish injection and production flow rates.

4. Well design and construction

Again, the design and construction of the wells must be adapted to the specific conditions of the orebody to be exploited. The choice of casing material (PVC, fiberglass reinforced plastic or stainless steel) is primarily dictated by the depth of the aquifer. The type of screening should be carefully selected. The choice of drilling additives is also important.

5. Leaching reagents

Pre-treatment of the orebody may improve oxidation and the ability to restore the aquifer. It is important to keep in mind that leaching chemistry can have an effect on the permeability of the orebody. Acid leach systems can benefit from oxidation by transition elements.

6. Chemical processing

Innovative approaches are being studied to improve chemical processing of leach liquors. Particular attention is being given to the concentration and purification step. Specialized ion-exchange systems, membrane systems and biological sorbents have potential applications for the recovery of uranium. Processes are also being perfected for the recovery of by-products. The use of satellite fields with a central processing plant helps to reduce labor costs and allows economic exploitation of small orebodies within a limited region.

7. Restoration of aquifers

Restoration of aquifers at a reasonable cost is essential for a successful project. The effect of the natural geochemistry of the orebody on long-term stability must be established. Selenium and arsenic must be continuously removed to prevent restoration problems. A balance must be made between the environmental impact on the surface of the well-field and the impact on the groundwater.

8. Economic aspects

The economic evaluation of an in-situ project must include criteria for groundwater restoration and well-field replacement costs. Simplified operating procedures, improved well-field design and improved well-field instrumentation help reduce costs. Low labor costs are very important for the economic feasibility of a project.

9. Waste disposal

Suitable arrangements must be made for the disposal of liquid wastes. These can be disposed of by injection in deep wells or by treatment on the surface and discharge by irrigation.

PANEL 2

SUMMARIES OF NATIONAL EXPERIENCE IN IN SITU LEACHING

Chairman: W.C. Larson (United States of America)

The use of in-situ leaching is limited to orebodies that meet certain specific geological requirements and that cannot be profitably exploited by conventional methods. In practice, this technique has been used successfully in only a few uranium provinces, notably in Southeast Texas, New Mexico and Wyoming (United States). Some activity has been reported in other countries, as follows:

France

From 1967 to 1972, COGEMA exploited a deposit in West Central France by in-situ leaching. This was a vein-type deposit with uranium dissemination in vertical pipes. The deposit was initially mined by open pit, then by underground works and finally by in-situ leaching. About 1/2 million pounds of U_3O_8 were produced. No restoration was attempted but there have been no environmental problems. No additional in-situ projects are currently envisaged. All anticipated future production is expected to be by conventional methods.

Turkey

The Yogat Sorgun deposit is being studied for possible development. In situ-mining is being considered. There are no other on-going activities. They have workers in the United States

United States

There has been considerable activity in in-situ mining involving about 30 different projects in various stages of development: some are under study or being planned, others are in operation and still others are either closed or on stand-by. Uranium from in-situ leaching and from phosphoric acid currently accounts for about 45% of the total U.S. production. However, the situation in the United States is very sensitive to market conditions and is constantly changing. It is difficult to prepare a "current" listing of operations.

KNOWN STATUS OF THE ISL OF URANIUM INDUSTRY IN THE WORLD

Country	Location	Owner	Capacity (tU/y)	Status	Year
Australia	Beverley	Western Nuclear Aust.	200	US	1988
"	Honeymoon	Mines Administration	100	"	"
Portugal	Urgeirica	ENU	15	OP	1951
USA	Bruni	Mobil	330	OP	1977
"	Burns	U.S. Steel Corp.	400	OP	1981
"	Clay West	US Steel/Niagara Mohawk	400	OP	1975
"	Crow Butte	Ferret Exploration	-	PL	1987
"	Hobson	Chevron Resources Co.	400	OP	1979
"	Las Palmas	Everest Minerals	100	OP	1984
"	Palangane	Chevron Resources	-	-	1986
"	Treviño	Conoco	150	OP	1981
"	Zamzow	IEC	100	OP	1977

U.S. Under Study; O.P. operating; PL planned

USSR

Research on in-situ leaching was started in the early sixties. Several deposits are currently being exploited by in-situ leaching, but no details are available.

Belgium, Egypt, Israel, the Federal Republic of Germany, Poland, the United Kingdom and Yugoslavia reported no activities or plans for in-situ leaching.

Egypt

No uranium is currently being produced. Uranium has been found in phosphate deposits and in black sands. Plans for the recovery of uranium from phosphate rocks are being carried out.

Israel

Research is being done on the recovery of uranium from phosphate rocks. No other uranium activities are currently in progress or envisaged.

Poland

Some uranium occurrences have been found in the north of the country, but they have not been developed. There seem to be no uranium deposits suitable for in-situ mining

Yugoslavia

One open pit uranium mine is in operation. No work has been done on in-situ mining although this technique was considered for one deposit. It could not be used because it is located near a populated area. Considerable work has been done on uranium recovery from phosphoric acid and a pilot plant is being built. Some work has also been done on uranium recovery from coal ash.

PANEL 3

DEVELOPMENT OF IN SITU LEACHING PROJECTS

Chairman: S. Ajuria (IAEA)

The objective of this Panel was to draw broad guidelines for the development of a new project for the recovery of uranium by in-situ leaching. These guidelines are expected to be useful to mining and metallurgical engineers with limited experience with in-situ leaching.

In situ leaching may be used to advantage for the exploitation of relatively deep deposits whose grade and tonnage make conventional mining (open-pit or underground) uneconomic. However, this technique can only be used in orebodies that meet certain specific geological criteria, as discussed below.

The development of a project for in-situ leaching of uranium is in general terms similar to the development of a project using conventional technology. This topic has been discussed in detail in other IAEA publications (1). The major differences are discussed below.

1. Geological conditions needed for in-situ leaching

The deposit must be in a permeable zone below the water table. There should be confining (impermeable) layers above and below the deposit, and there should be an artesian head. The ore should be leachable, preferably with carbonate solutions or other relatively mild reagents. Leaching with strong mineral acids should be avoided if possible. It is easier to leach a low-grade ore in a thick deposit than a high-grade ore in a thin deposit.

2. Geological assessment

The tonnage, grade and thickness of the deposit should be determined. The location of the ore-bearing zones with respect to the confining impermeable layers should be established. The best conditions for in situ leaching are when the ore is concentrated at the top of the mineralized layer. The next best conditions are when the ore is at the bottom and the worst conditions are when the ore is in the middle of the mineralized layer. Permeabilities, both vertical and horizontal should be measured. The ratio of vertical to horizontal permeability should be about 10 to 1.

3. Sampling

Ore samples are usually recovered by drilling and coring. These samples are used to establish the grade, tonnage and geometry of the orebody, to study its mineralogy and to perform preliminary leaching tests. It is important to determine what are the geochemical conditions underground: ground water samples should be recovered and analyzed,

(1) Development of Projects for the Production of Uranium Concentrates.-
Proceedings of a Technical Committee Meeting, Vienna, Austria, 1985.
(STI/PUB/738), November 1987

although they are of limited use. Attempts have been made to retrieve samples which preserve the existing pH, EMF and the content of dissolved gases but these attempts have not been very successful.

4. Bench-scale testing

Conventional bench-scale leaching tests can be done in agitated vessels using suitable oxidants. These tests may be useful but the results should be interpreted with care because the conditions underground cannot be easily duplicated in the laboratory. Leach tests in columns (either vertical or horizontal) are more useful. Column tests can be done with columns 2.5 to 3 feet high and about 2 inches in internal diameter. Such columns may contain about 2 kg of ore. Care should be taken not to compact the ore too much. The packing density of the ore should approximate that of the original ore underground.

5. Modelling

It is essential to develop models of the aquifer in order to better understand its nature, to measure its permeability and to determine how the permeability varies in the different directions, to determine what are the different reservoir conditions and what overall extraction can be expected. This information is essential for well-field design. Modelling is, however, a complex task and must be based on experience. Models should be validated by reference to actual test results.

6. Licensing

Licensing has become a very important part of any uranium project. It is particularly important in the case of in-situ mining because of its environmental impact on ground water. Licensing procedures should begin at least a year before field tests are expected to commence.

7. Field tests

Field tests are essential to confirm the laboratory results, to validate aquifer models, to gather engineering data and to gather data needed for capital and operating cost estimates and for the final feasibility study. Field tests are also useful to obtain information about the consistency of the geology and of the mineralization. Field tests may be push-pull or continuous.

8. Economic considerations

The economic criteria applicable to in-situ leaching projects are similar to those used in conventional projects. Specific items which are unique to in-situ projects should be taken into account, such as initial and replacement well-field costs and aquifer restoration costs. In-situ projects require less capital investment, usually in the range of 5 to 10 million US dollars as compared to 50 to 100 million for a conventional project. Lead times are also shorter, in the order of 3 to 5 years.

9. Production

When all the preparatory work has been properly done production can be started by expanding the test well-field or fields.

10. Restoration

After completing the exploitation of the field the aquifer must be restored to conditions as close as possible to those originally present.

PANEL 4

ECONOMIC CONSIDERATIONS

Chairman: W.C. Larson (United States of America)

1. Cost comparison between in-situ leaching and conventional processing.

The most important differences are in the capital investment required. Capital investment for an in-situ project (representing 50-80% of the total cost) could be 5-10 million dollars compared to 50 to 100 million for a conventional mill.

Operating costs in an in-situ project are about 15-17 \$/lb and the total production cost is of the order of 20-25 \$/lb.

The U.S. Bureau of Mines has developed a sophisticated economic model to estimate production costs for in-situ projects. In one example the production costs calculated for an in-situ project operating for 10 years at a production rate of 100 t/y ranged from 23 to 41 dollars/lb for an internal rate of return of 20% and were lower for an IRR of 10%.

That means that an in-situ operation can compete favourably with small existing conventional mills in the United States.

2. Selection criteria

Assuming that the geological conditions of an orebody allow the use of in-situ leaching, it is still necessary to decide whether to use this technique or conventional milling. Many factors must be taken into account when making this decision.

Technical considerations.- The production capability of an in-situ project is generally limited to 1 to 1.5 million pounds O₂O₈ per year.

Environmental and licensing requirements may be more stringent for in-situ projects, particularly regarding groundwater contamination. Public acceptance of the project is also an important, and perhaps crucial, factor.

Financing. Capital requirements are less for an in-situ project than for a conventional mill.

Marketing. Type of sales contracts that may be negotiated may be a decisive factor. A conventional mill must rely heavily on long-term contracts at relatively high prices (of about 30 Dlls./lb). An in-situ project has more flexibility to respond to changing market conditions and can operate on short term contracts (3 to 5 years) or with spot market sales. A large proportion of the uranium produced by in-situ leaching is sold in the spot market.

LIST OF PARTICIPANTS

Busch, K. Bundesanstalt für Geowissenschaften
und Rohstoffe - BGR
Postfach 510153
Stilleweg 2
D-3000 Hannover 51, Federal Republic of Germany

Chanda, M.W. University of Zambia
School of Mines
P.O. Box 32379
Lusaka, Zambia

El-Yamani, I.S. Atomic Energy Authority
Nuclear Chemistry Department
Nuclear Research Centre
101, Kasr El-Eini Street
Cairo, Egypt

Gharib, A.G. Atomic Energy Organizations of Iran
AEOI
P.O. Box 11365-8486
North Kareghar Ave.
Teheran, Iran

Graul, H. Urangesellschaft mbH
Bleichstrasse 60-62
D-6000 Frankfurt 1, Federal Republic of Germany

Hunter, J. Central Electricity Generating Board
Sudbury House
15, Newgate Street
London EC1A 7AU, United Kingdom

Larson, W.C. U.S. Department of Interior
Bureau of Mines
Twin Cities Research Center
5629 Minnehaha Ave. South
Minneapolis, Minnesota 55417, U.S.A.

Mahdy, M.A.H. Nuclear Materials Corporation
P.O. Box 530
El Kattamia Rd.
El Maadi, Cairo, Egypt

Miecznik, J.B. Institut National de Geologie
Ul. Rakowiecka 4
00-975 Warszawa, Poland

Montgomery, A.H. Canonic Environmental Services Corp.
6551 S. Revere Pkwy, Suite 155
Englewood, Colorado 80111, U.S.A.

Okutan, H. Istanbul Technical University
Department of Chemical Engineering
Maslak-Istanbul, Turkey

Oner, G. Istanbul Technical University
Department of Chemical Engineering
Maslak-Istanbul, Turkey

Petcovic Institute for Technology of Nuclear and
other Mineral Raw Materials
P.O. Box 890
Franche D'Epere 86
11000 Belgrade, Yugoslavia

Pype, J.M.C.M. Synatom
Avenue Marnix 13
B-1050 Bruxelles, Belgium

Przenioslo, S.M. Institut National de Geologie
Ul. Rakowiecka 4
00-975 Warszawa, Poland

Renardet, P. COGEMA
Direction des Mines et Usines
Department des Exploitations Minières
2, Rue Paul Dautier
78141 Velizy Villacoublay, France

Sadykov, R.H. State Committee of the Utilization
Of Atomic Energy
Staromonetny perulok 26
Moscow 109180, U.S.S.R.

Schmidt, C. Uranerzbergbau-GmbH
Kölnstrasse 367
D-5340 Bonn 1, Federal Republic of Germany

Seidel, Don S. U.S. Bureau of Mines
729 Arapeen Drive
Salt Lake City, Utah 84108, U.S.A.

Sollenberger, D. Office of Nuclear Material Safety
and Safeguards
Nuclear Regulatory Commission
MS 697
Washington, D.C. 20550, U.S.A.

Tolic, A. Institute for Technology of Nuclear and
other Mineral Raw Materials
P.O. Box 890
Franche D'Epere 86
11000 Belgrade, Yugoslavia

Volkman, Y. Israeli Atomic Energy Commission
P.O. Box 9001
Beer-Sheva 84190, Israel

ORGANIZATION

International Atomic Energy Agency (IAEA)

Ajuria S., Division of Nuclear Fuel Cycle
Rojas, J.L. (Scientific Secretary), Division of Nuclear Fuel Cycle