



DESIGN STUDY ON AN RFQ FOR THE BASIC TECHNOLOGY ACCELERATOR IN JAERI

K. Hasegawa, M. Mizumoto, H. Murata, K. Sakogawa and H. Yokobori
Accelerator Engineering Laboratory
Japan Atomic Energy Research Institute
Tokai-mura, Naka-gun, Ibaraki-ken, 319-11, Japan

Abstract

A 2MeV, 110mA, 10% duty, 201.25 MHz RFQ has been designed for the Basic Technology Accelerator (BTA) by Japan Atomic Energy Research Institute (JAERI). In this report, the design parameters, LEBT study, acceleration efficiency correction due to the two-dimensional vane-tip machining, frequency tuning of the vane-end region and thermal considerations are presented.

Introduction

A high intensity proton linear accelerator (ETA: Engineering Test Accelerator) with an energy of 1.5GeV and a current of 10mA has been proposed for the accelerator-driven nuclear waste transmutation[1]. In the course of the accelerator development, low energy portion of the accelerator (BTA: Basic Technology Accelerator) is planned to be built, and thus, average beam current of 10mA is required for the BTA. For the RFQ design, peak current of 110mA and duty factor of 10% was chosen. The RFQ resonator is a four-vane type and the frequency is 201.25 MHz. For the design, CURLI, RFQUIK and PARMTEQ[2] codes were used. The Low Energy Beam Transport (LEBT) from the ion source to the RFQ was designed to match the RFQ acceptance. Two-dimensional machining of the vanes (circular cross section of the tip) was considered and reduction of the acceleration efficiencies due to the vane-tip geometry effects was corrected. Three-dimensional code of MAFIA[3] was used to study the undercutting of the vanes and distribution of the power loss density in the end region. Temperature distribution and thermal displacement of the vanes were studied with the three-dimensional finite element modeling code of ABAQUS.

RFQ Design

For the design of the RFQ, the standard LANL approach[4] was used. The RFQ resonator is a four-vane type. Table 1 shows the parameters of the RFQ. The RFQ parameters as a function of distance along the RFQ beam line are shown in Fig. 1. Proton beam from the ion source with an energy of 0.1 MeV is accepted and accelerated up to 2 MeV. Beam current is 110mA and duty factors for the beam and RF are 10%, 12%, respectively. The intervane voltage is 0.113MV, which corresponds to the peak surface electric field of 26.5 MV/m (1.8 times Kilpatrick limit) using the conventional field enhancement factor of 1.36. The output emittance and transmission rate were calculated with the PARMTEQ code. Iterative design procedure from RFQUIK to PARMTEQ was taken to optimize the output emittance, transmission rate and RFQ length.

The SUPERFISH code was used to calculate the resonant frequency in the RF cavity, to determine the shape of the structure, to predict the frequency sensitivity and to estimate the mechanical fabrication tolerances. Various results related to the electromagnetic field were obtained such as quality factor (Q), electric field strength and RF wall loss power.

Table 1
Design parameters of the BTA-RFQ

Particle	Proton	
Frequency	201.25	MHz
Energy	0.1 - 2	MeV
Beam Current	110	mA
Duty Factor	10	%
Synchronous Phase	-90° - -35°	
Vane Voltage	0.113	MV
Focusing Parameter B	7.114	
Number of Cell	181	
Cavity Diameter	36.6	cm
Vane Length	334.8	cm
Quality Factor (Q)	~13000	(100% Q)
Wall Loss Power	432	kW (60% Q)
Beam Power	209	kW
Normalized Emittance		
LEBT Input (100%)	x,y: 0.05	π cm·mrad
(rms)	x,y: 0.0083	π cm·mrad
RFQ Input (98%)	x,y: 0.085	π cm·mrad
(rms)	x,y: 0.0123	π cm·mrad
RFQ Output (98%)	x: 0.19	π cm·mrad
(rms)	x: 0.0203	π cm·mrad
(98%)	y: 0.17	π cm·mrad
(rms)	y: 0.0187	π cm·mrad
(98%)	z: 0.0402	π MeV·rad
(rms)	z: 0.0027	π MeV·rad
Transmission	94	%
Energy Resolution (rms)	0.6	%

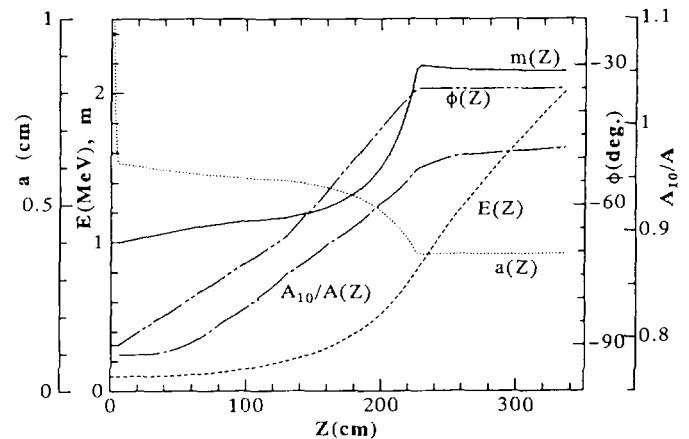

Fig. 1 RFQ parameters as a function of distance along the beam line in the RFQ

LEBT Study

To obtain the desired transmission rate and better output emittance through the RFQ, the input beam emittance should be matched to the RFQ acceptance. The Low Energy Beam Transport (LEBT) consisting of two-focusing solenoids was designed with the TRACE code[5] for the first step. By using the PARMILA[6], modified for a DC beam simulation,

emittance growth in the LEBT was estimated. Particle information from the PARMILA was used as an input of the PARMTEQ for beam transport calculation of the RFQ, and the magnetic fields of the two solenoids were determined to obtain the better transmission rate and emittance through the RFQ. The beam envelope in the LEBT and the $x-x'$ emittance diagrams at the output positions of the ion source, LEBT and RFQ are shown in Fig. 2. The output emittance and transmission rate listed in Table 1 are also the results of the LEBT-RFQ joint simulation.

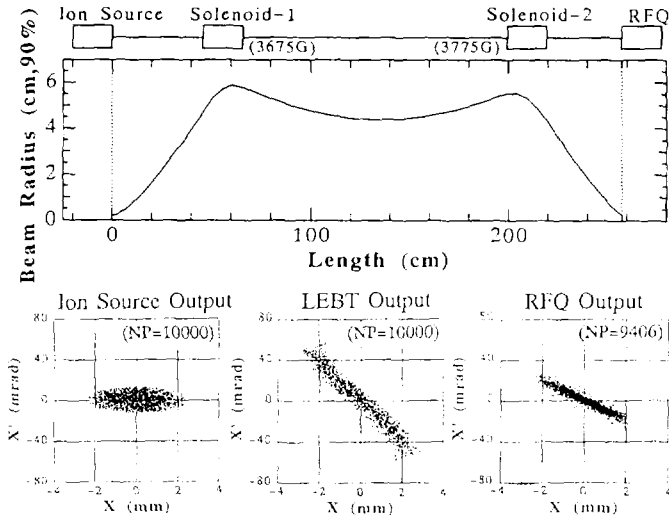

Fig. 2 Beam envelope in the LEBT, and $x-x'$ emittance diagrams at the output positions of the ion source, LEBT and RFQ

Correction of the Acceleration Efficiency

The transverse cross sections of the RFQ based on the two-term potential function are approximately hyperbolae. The circular cross section of the vane-tip reduces the maximum electric field intensity and requires less machining processes than the hyperbolic cross section. For these reasons, circular cross sections of constant transverse curvature ($\rho=0.75r_0$, where r_0 is an average bore radius) were adopted for the BTA-RFQ. By taking this vane-tip geometry, reduction of the peak surface field from 26.5 to 24.7 MV/m is expected. Vane-tip geometry effects, however, should be corrected to simulate the particle dynamics. PARMTEQ code was modified to take into account the acceleration efficiency reduction ratio (A_{10}/A , where A and A_{10} are acceleration efficiencies for the two-term potential function, and for the fundamental term of the multipole potential function, respectively) calculated by Crandall[7]. Variation of A_{10}/A in the RFQ is also shown in Fig. 1. Fig. 3 shows the proton beam transmission rate through the RFQ as a function of normalized intervane voltage, V_n . Because of the reduction of the acceleration efficiency, 89% transmission rate was expected at $1.0V_n$, where the original PARMTEQ (two-term potential function) gives 95%. For the vanes with the circular cross sections, the ideal acceleration efficiency (A) can be obtained by adjusting the modulation factor (m) and bore radius (a) by using the iteration processes[8]. These modified parameters were adopted for the BTA-RFQ, since almost the same transmission rate could be expected as the original PARMTEQ.

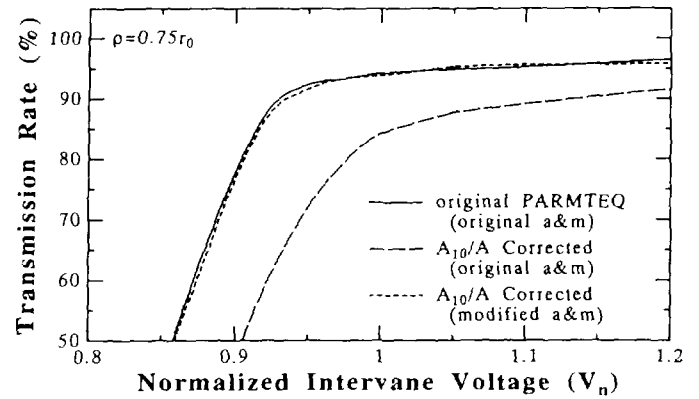

Fig. 3 Transmission rate of the RFQ as a function of normalized intervane voltage, V_n . ($1V_n=113kV$)

Vane Undercutting

The resonance frequency of the vane end region should be matched to the cut-off frequency of the TE_{210} -mode, which is an operating frequency as an RFQ. In this study, three-dimensional electromagnetic calculation code of MAFIA was used, and the similar procedures to Browman's[9] were taken. An example of the structure and cross section of the end region are shown in Fig. 4 and Fig. 5, respectively. Because of the symmetry of the geometry, one quadrant model of the RFQ structure was generated. First, the frequency of TE_{210} -mode (207.758MHz) was obtained without end region. Then the end region was generated by undercutting of the vane structure. Several parameters such as gap length (g), overhang length (s), and slope angle (θ) were adjusted to match the TE_{210} -mode frequency. Fig. 6 shows the frequency as a function of gap length for three slope angles. The end region with a slope angle of 39.4° and a gap length of 8 mm matches well the cut-off frequency.

By using this code, dissipation of the RF power loss density was also calculated. Obtained relative values were normalized to the cavity wall point from the SUPERFISH results. Fig.7 shows the peak power loss density along the surface of the vane.

Thermal Considerations

With the heat load distributions specified by the MAFIA and SUPERFISH, a finite element analysis code (ABAQUS) was used to study the thermal behavior for the mechanical structure design. Vanes are made of oxygen free copper with two cooling water channels ($\phi 20mm$). Water flow through each channel is 30 l/min, and average temperature is $25.5^\circ C$. Fig. 8 shows a temperature distribution and displacement on the surface of the vane. Calculated maximum temperature is $39.1^\circ C$, and displacement in the transverse and longitudinal directions are $33 \mu m$, $99 \mu m$, respectively. These deformations are small enough both for the frequency tuning and for the beam dynamics aspects.

Status

Most of the design parameters have been fixed and the design drawings are almost completed. Some components have been ordered. The high power tests will be started in the middle of the FY-1993.

Acknowledgement

The authors would like to thank Dr. Y. Kaneko and Dr. T. Hiraoka for their encouragement and support for the present work.

References

- [1] M.Mizumoto et al., "High Intensity Proton Accelerator For Nuclear Waste Transmutation", these proceedings.
- [2] K.R.Crandall and T.P.Wangler, "PARMTEQ-A Beam Dynamics Code for the RFQ Linear Accelerator", LA-UR-88-1546 (1988)
- [3] R.Klatt et al., "MAFIA-A Three-Dimensional Electromagnetic CAD System for Magnets, RF Structures and Transient Wake-Field Calculations", Proc. of 1986 Linear Accelerator Conference, p276-278, SLAC-303, Stanford (1986).
- [4] K.R.Crandall, R.H.Stokes and T.P.Wangler, "RF Quadrupole Beam Dynamics Design Studies", Proc. of 1979 Linear Accelerator Conference, p205-216, BNL-51134, Montauk (1979).
- [5] K.R.Crandall and D.P.Rusthoi, "Documentation for TRACE: An Interactive Beam-Transport Code", LA-10235-MS (1985).
- [6] G.Boicourt and J.Merson, "PARMILA Users and Reference Manual", LA-UR-90-127 (1990).
- [7] K.R.Crandall, "Effects of Vane-Tip Geometry on the Electric Fields in Radio-Frequency Quadrupole Linacs", LA-9695-MS (1983).
- [8] K.R.Crandall, R.S.Mills and T.P. Wangler, "Radio-Frequency Quadrupole Vane-Tip Geometries", IEEE Trans. Nucl. Sci., NS-30 p.3554-3556, (1983).
- [9] M.J.Browman, G.Spalek and T.C.Barts, "Studying the End Regions of RFQs Using the MAFIA Codes", Proc. of 1988 Linear Accelerator Conference, p64-66, Williamsburg, (1988).

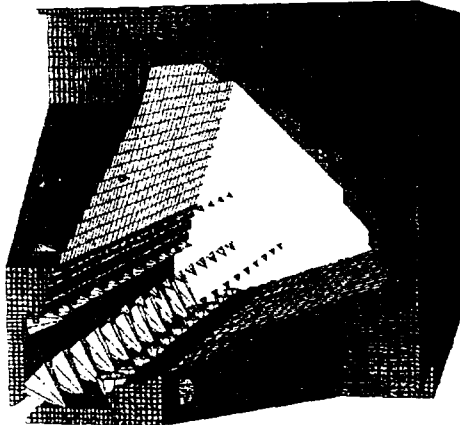

Fig. 4 Three-dimensional RFQ structure with vane end region generated with MAFIA. Arrow shows the electric field vector.

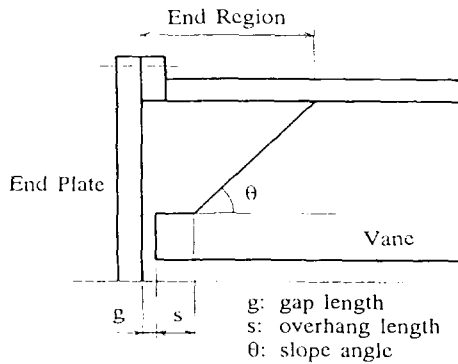

Fig. 5 Cross section of the RFQ end region

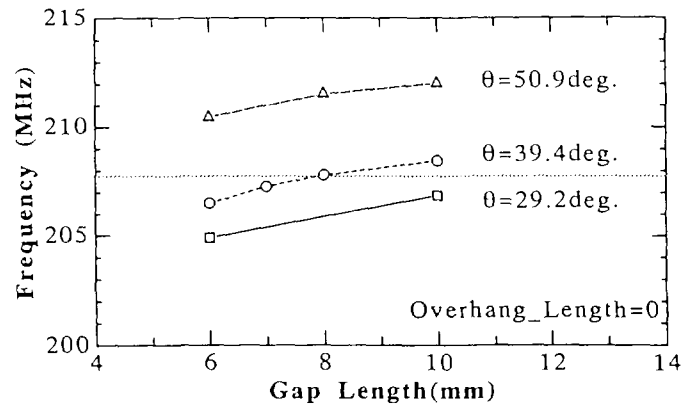

Fig. 6 Resonance frequency as a function of gap length for vane slope angle of 29.2, 39.4 and 50.9 deg. calculated with MAFIA

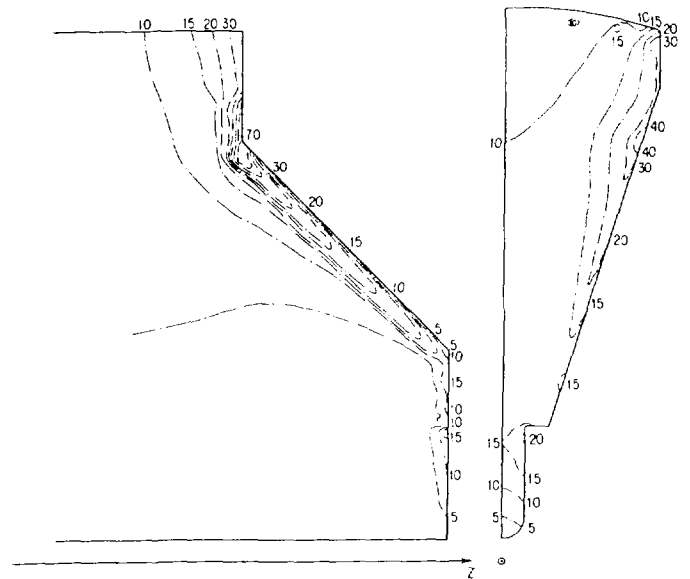

Fig. 7 RF peak power loss density in W/cm^2 along the surface of the vane. (60%Q is assumed.)

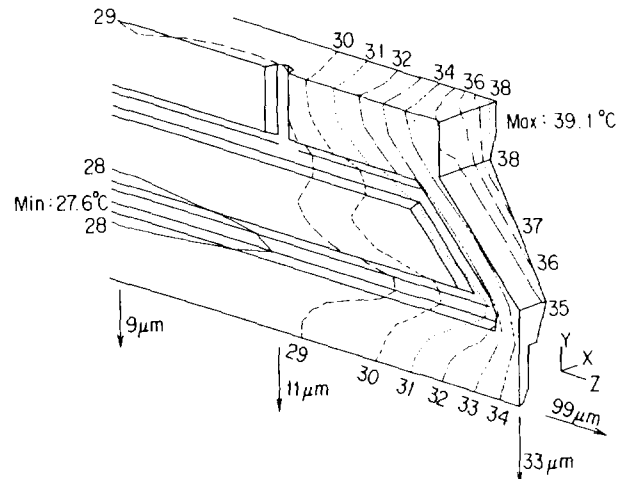

Fig. 8 Temperature distribution and displacement of the RFQ vane