

# Onset of Flow Instability in a Rectangular Channel Under Transversely Uniform and Non-uniform Heating

Omar S. Al-Yahia, Taewoo Kim, Daeseong Jo

School of Mechanical Engineering, Kyungpook National University  
80 Daehak-ro, Buk-gu, Daegu 702-701, Republic of Korea

Corresponding author: djo@knu.ac.kr

## Abstract

Flow instability in a narrow rectangular channel (2.35 mm x 54.0 mm x 300 mm) is studied under uniform and non-uniform heating conditions since the power released from the nuclear fuel is not uniform in the axial and transverse directions. Transverse non-uniform heating may cause local boiling where local heat flux is relatively higher than other locations. This may occur boiling locally, which disturb or generate a different velocity profile compared with that under uniform heating. The velocity profile change is significant when the flow condition reaches the Onset of Flow Instability (OFI). In the present study, an experimental facility has been designed to study the effects of non-uniform heating on the velocity profiles. Experiments are carried out using two different ways to reach the OFI; (1) decreases flow rate with constant power and (2) increases power with constant flow rate. When the flow reached the OFI, the pressure drop changes show different trends. This is because the flow travels faster where there is a significant boiling than that where there is not. This study shows different boiling behaviors in a narrow rectangular channel under transversely uniform and non-uniform heating.

## 1. Introduction

Although the subcooled flow boiling has high heat transfer capacity, the two-phase flow is unacceptable in the nuclear reactors. Because any small existence of bubbles will introduce fluctuation in the reactivity due to the void fraction feedback. Thus, the accurate estimation boiling incipience and understanding the consequences of two-phase flow are very important for the safety of research reactors. Many experimental and numerical studies were carried out to investigate and analyze the thermal hydraulic behaviors when the onset of nucleate boiling (ONB) and onset of flow instability (OFI) occur; [1-4]. ONB is referred to the location where a vapor bubble can first exist at a heated surface, and OFI is referred to the moment when the void fraction becomes significant enough to introduce instability in the mass and heat transfer conditions, which is usually considered as the minimum point on the pressure drop-mass flow rate curve, as shown in *FIG.1*, in which the slope of pressure drop - mass flux curve for the pump supply curve is larger than the system demand curve;

$$\left. \frac{\partial \Delta P}{\partial G} \right|_{Supply} \geq \left. \frac{\partial \Delta P}{\partial G} \right|_{Demand} \quad \text{Flow instability condition} \quad (1)$$

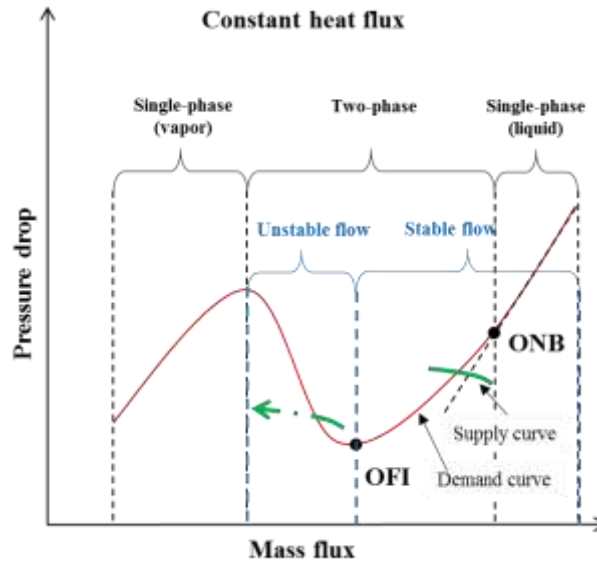

FIG. 1. Pressure drop variation with mass flux at constant heat flux and inlet temperature.

ONB is local phenomena depending on the local heat flux. However, OFI depends on the total thermal power deposited in the flow channel. In the plate type fuel research reactors, the power distribution is non-uniform along the axial direction as well as the transverse direction. The temperature near the edges in the transverse direction is higher than the temperature in the middle, due to the higher heat flux near the edges, [5]. The influence of transverse heat flux distribution on the ONB was studied using CFX and TMAP code [6] and investigated experimentally [7]. In their results, the ONB in the non-uniform heating occurs at lower power and earlier than the one in uniform heating case. However, an experimental or analytical studies to show the influence of the transverse power distribution on OFI has not been addressed yet.

In the present work, an experimental study is carried out to investigate the effect of transverse power distribution on the OFI. The measurement data method as well as the visualization using the high speed camera are conducted to identify the ONB and OFI on the heated surface. The present study provides further understanding of two-phase flow from ONB until OFI incipience by comparing the thermal hydraulic behaviors under uniform and non-uniform heat flux distribution.

## 2. Experimental apparatus

An experiment on flow boiling through a narrow rectangular channel in upward direction was performed using demineralized water under atmospheric pressure. The facility is schematically shown in FIG.2. The facility consists of the test section, water tank, condensing tank, heat exchanger, circulation pump, flow meter, preheater, pressure transmitter, two pressure transducers, thermocouples, high-speed camera, and data acquisition system (DAQ). In order to measure the inlet and outlet conditions, two TCs and two pressure transducers are installed at the inlet and outlet of the test section. On the other hand, a pressure transmitter is installed to measure the pressure drop through the test section. More details about the experimental loop were explained by Al-Yahia and Jo [4]. The experiment is performed under atmospheric pressure for demineralized water flowing in upward direction with varying mass flux, heat flux, and inlet temperature. The test parameter and test matrix are summarized in Table I.

TABLE I. Test conditions

Parameter	Value
Flow rate [kg/s]	0.030-0.130
Heat flux [kW/m <sup>2</sup> ]	100-800
Power distribution	Uniform/Non-uniform
Inlet temperature [C]	35-65
Pressure	atm~
Hydraulic diameter [m]	0.004504

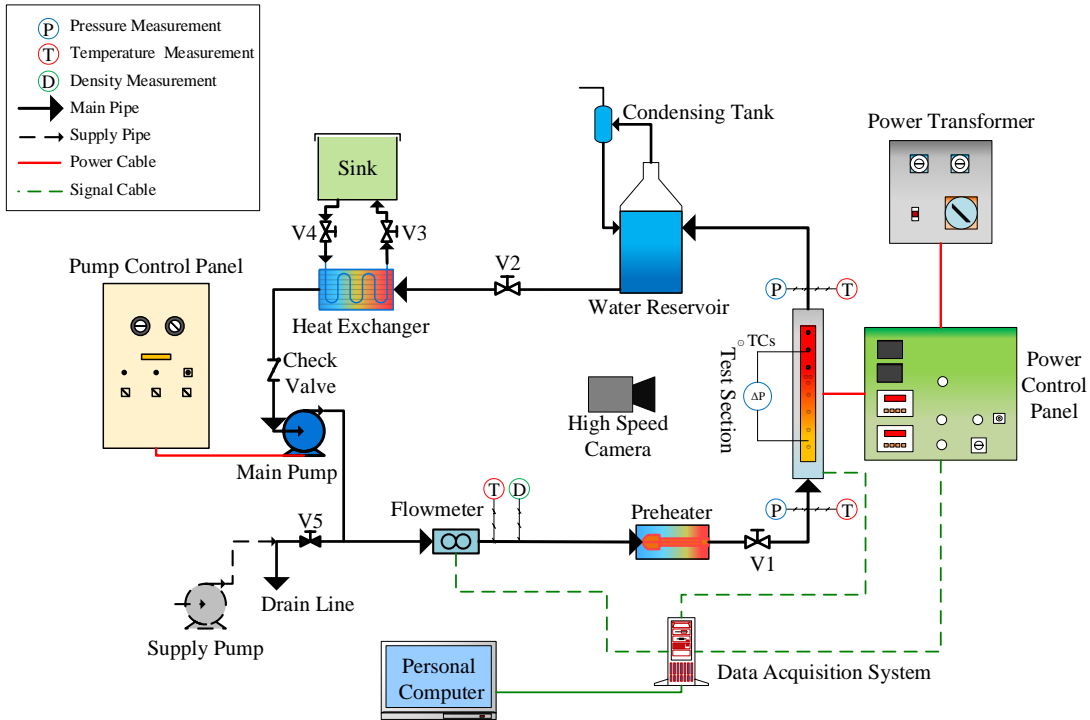

FIG. 2. ONB experimental facility

## 2.1. Test section

Two narrow rectangular test sections are used to perform the experiment; uniformly heated and non-uniformly heated. The coolant channel is heated from one-side and the other side is polycarbonate window to visualize the bubble behavior using high speed camera with a resolution of  $512 \times 512$  at recording rate of 2200 fps. The channel thickness and width is 2.35 mm and 54 mm, respectively. The total length of the channel is 560 mm, whereas the heated length and width is 300 mm and 50 mm, respectively. The unheated length is 133 mm at each end. The uniformly heated test section is a two stainless steel (SUS316L) cartridge heaters are installed into an aluminum block, as shown in FIG. 3(a). Ten thermocouples (TCs) are inserted into the heated block from the back side that they are 1.2 mm away from the heated surface. Eight TCs are distributed axially along the centerline of the heated surface with 32 mm distance between each of them. Two TCs are installed in the transverse direction at 166 mm from the beginning of the test section, as shown in FIG. 3(b).

On the other hand, the non-uniform test section is consist of two stainless steel cartridge heaters inserted in copper block, and the copper block is connected to aluminum block, in which the

other side of the aluminum block is exposed to the coolant channel. A 1 mm air gap between the copper block and the aluminum block, as shown in FIG. 4(a). This gap allows the heat flux to be higher near the edges and lower at the middle. The gap width controls the power distribution; the wider gap the higher heat flux near the edge. The gap width in the present test section is 30 mm, to provide temperature distribution similar to the one in the plate type fuel research reactors. A twenty TCs are inserted into the aluminum block from the back side of the test section. In order to measure the temperature distribution on the heated surface, the TCs are distributed along the centerline and the two edges, as shown in FIG. 4(b). Seven TCs are double TC to measure the local heat flux. The distance between the double TCs is 2 mm.

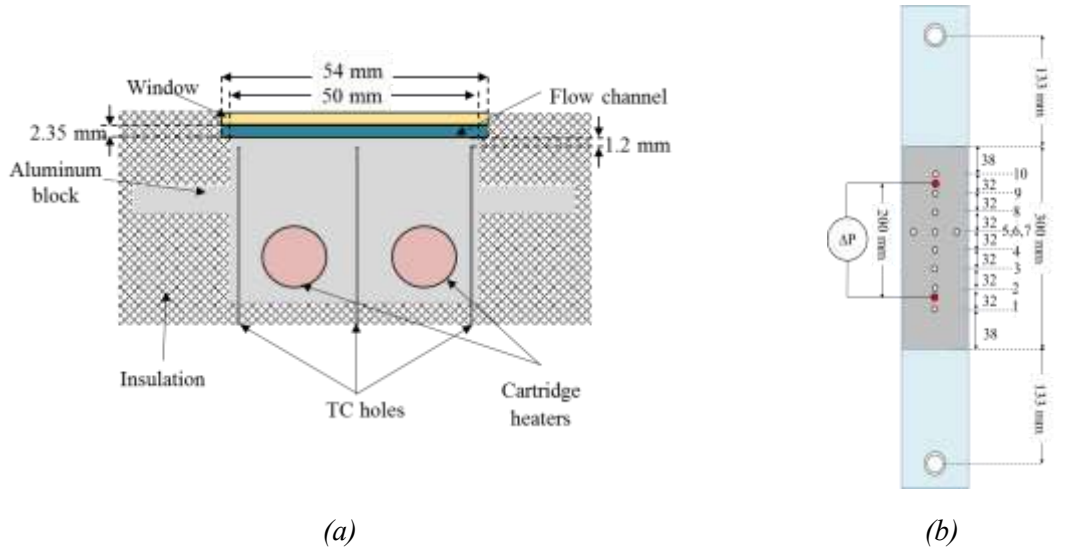

FIG. 3. Uniform test section test section; (a) Cross sectional view and (b) Front view

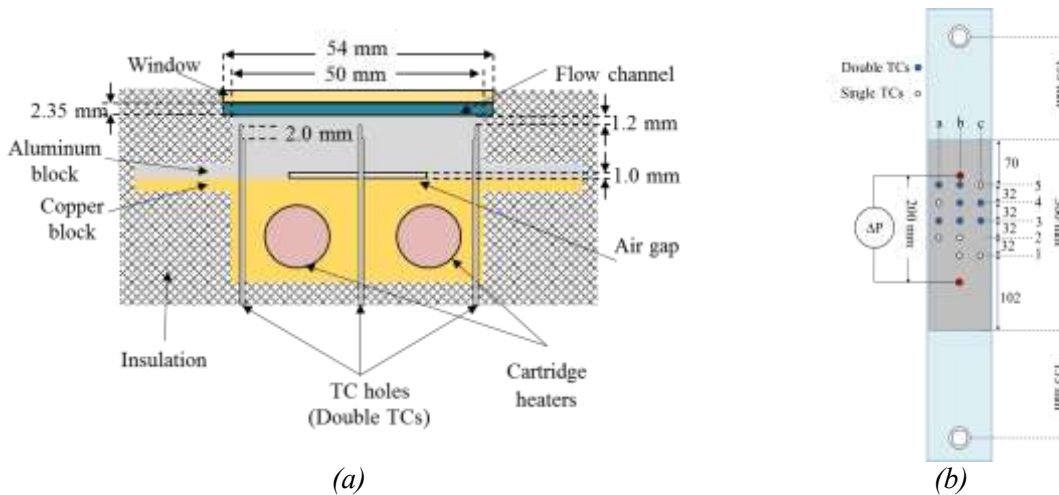

FIG. 4. Non-uniform test section test section; (a) Cross sectional view and (b) Front view

## 2.2. Experimental procedure

Degassing process is performed prior to the experiment to remove the non-condensable gases. The water is circulated through the loop with a temperature over 80°C, and it is allowed to boil on the heated surface for more than 30 min., which releases any entrapped gases on the heater surface. After that, the inlet conditions are fixed to the desire values. Experiments are carried

out using two different ways to reach the OFI; (1) decreases flow rate with constant power and (2) increases power with constant flow rate. As well, the experiments are performed step by step (as steady state) and continuously (as transient).

### 3. Data reduction

The electrical power is applied into the cartridge heaters and it is converted to thermal power, then it transfers to the coolant channel through the heated block. However, not all electric power transfers to the channel as thermal power. Therefore, the power loss is estimated based on the comparison between the thermal power and electrical power as shown in Eq. 2;

$$Energy\ Loss = \frac{Q_{th}}{Q_e} = \frac{\dot{m}C_p(T_o - T_i)}{I \times V} \quad (2)$$

where  $I$  is the electrical current,  $V$  is the voltage,  $\dot{m}$  is the mass flow rate,  $C_p$  is the coolant specific heat,  $T_i$  is the coolant inlet temperature, and  $T_o$  is the coolant outlet temperature. The energy losses is approximately 7 % and 10 % for uniform and non-uniform test section, respectively.

The thermocouples (TCs) measure the temperature in the aluminum block at distance of 1.2 mm away from the heated surface. Therefore, the one-dimensional conduction equation is used to evaluate the wall temperature as;

$$T_w = T_{TC} - \frac{q''_{loc}t}{k} \quad (3)$$

where  $T_w$  is the wall temperature on the flow side,  $T_{TC}$  is the measured temperature from the TCs,  $t$  is the distance between the TCs and the wall (1.2 mm),  $k$  is the thermal conductivity of the aluminum block ( $\sim 205$  W/m·K), and  $q''_{loc}$  is the local heat flux that is calculated in two different ways; for uniform heated test section

$$q''_{loc} = q''_{avg} = \frac{Q_e}{A_h} \times 0.93 \quad (4)$$

For non-uniform heated test section the heat flux is calculated based on the temperature reading from the double TCs ( $\Delta T_D$ ). The double TCs are located at the same point in the axial and transverse direction with a fixed distance (2 mm) between them in the cross direction, as illustrated in FIG. 4 (a);

$$q''_{loc} = \frac{k}{x} \Delta T_D \quad (5)$$

where  $x$  is the distance between the double TCs (2 mm). The heat flux at the edges is considered to be same for the locations that no have double TCs; the local heat flux at position (4-a) is equal to the local heat flux at position (4-c) [ $q''_{4,a} = q''_{4,c}$ ], also the same for the 5<sup>th</sup> location [ $q''_{5,c} = q''_{5,a}$ ].

### 5. Results and discussion

The ONB and OFI are observed at fixed position on the heated surface; position 6 is chosen for the uniformly heated test section, and position 3 for the non-uniformly heated test section, in which the distance at those points for the both test section is 166 mm from the beginning of the heated surface. The local heat flux for the uniform test section is similar at any location on the heated surface. However, the local heat flux near the edges is much higher than the middle part of the non-uniform heated section, as shown in FIG. 5. For the non-uniform heater, the heat flux near the edges is approx. 2.8 times higher than the heat flux at the centerline, and approx. 1.3 times higher than the average heat flux (uniformly heated). As a results, the bubbles are expected to occur near the edges for the non-uniformly heater, as shown in FIG. 6(a). However, it occurs in the middle part around the centerline for the uniformly heated surface, as illustrated in FIG. 6(b).

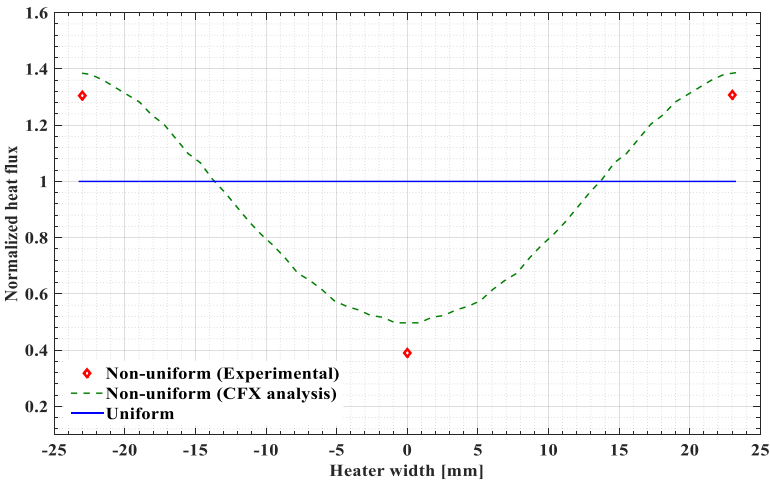

FIG. 5. Transverse normalized heat flux distribution (at 3.9 kW)

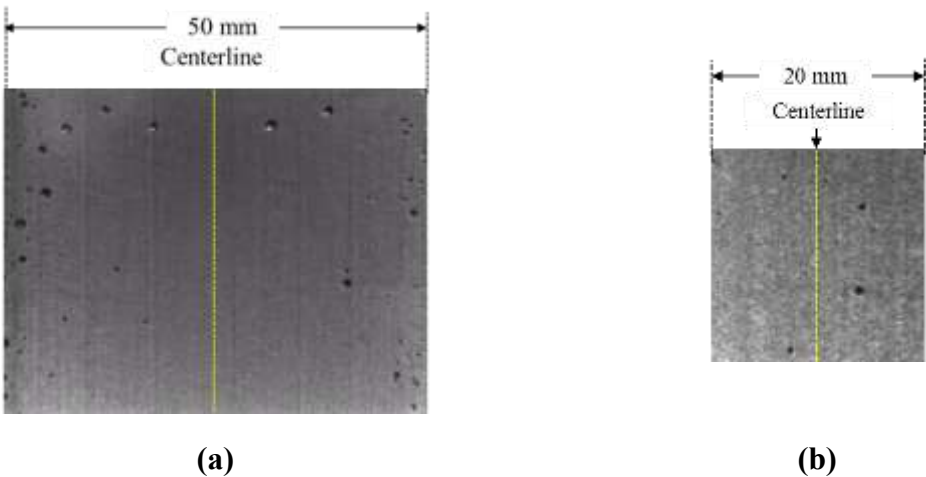

FIG. 6. ONB incipience on the heated surface; (a) Non-uniformly heated surface, (b) Uniformly heated surface.

## 5.2. Onset of nucleate boiling

ONB is identified using the wall temperature- thermal power curve. The inflection point in the curve is considered as ONB as shown in FIG.7, since the bubble formation on the heated surface leads to enhance the heat transfer, which occur reduction in the wall temperature. The ONB incipience is local phenomenon that is highly depends on the local conditions such as the local heat flux rather than the total power deposited in the channel. Regarding to the heat flux distribution, and at the same flow conditions, the ONB in the case of non-uniformly heater occurs at power lower than the one for the case of uniformly heated surface due to high heat flux near the edges, as shown in FIG.7. The shifting in the ONB toward lower power is clearly seen.

Although the ONB power for the case of non-uniformly heated is lower than the one for the uniformly heated, the local heat flux is similar, as shown in FIG.8, as well the local wall temperature at the ONB.

Bubbles are generated near the edges of the heated surface in the case of non-uniform heat flux. However, they are generated along the whole lateral direction in the case of uniform heat flux. As a result, the boiling heat transfer under non-uniform heat flux is less than it under uniform heat flux. For that reason the slope changes is less in the case of non-uniform. Although the bubbles are not generated in the middle for the non-uniform case, the wall temperature in the middle deviates due to the effect of heat conduction in the later direction.

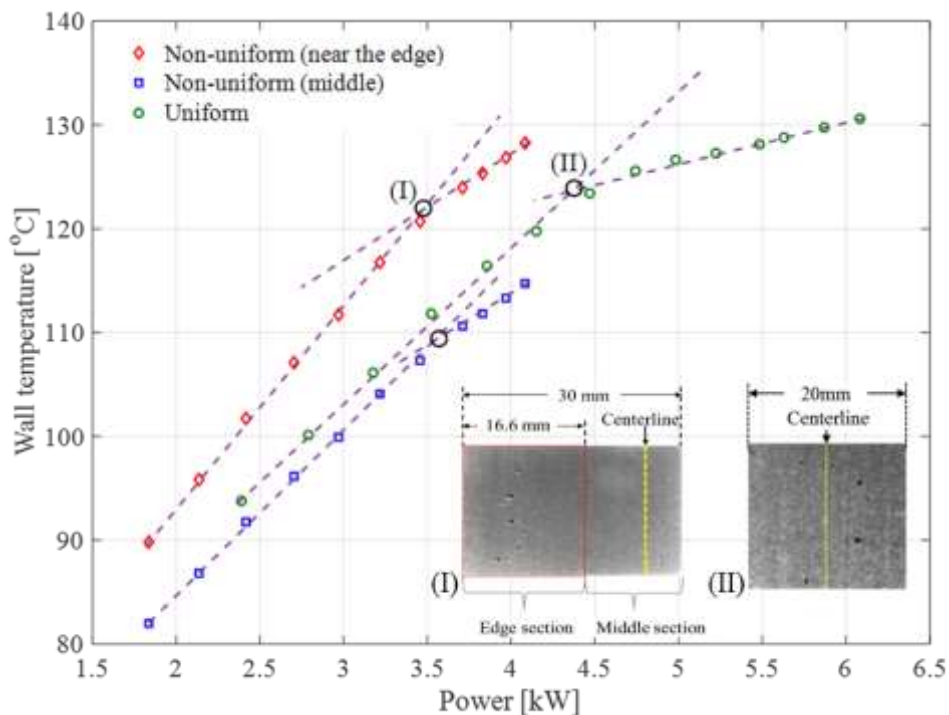

FIG. 7. The ONB incipience for uniform and non-uniform heat flux, (Mass flow rate is 0.08 kg/s, Inlet temperature is 50 °C)

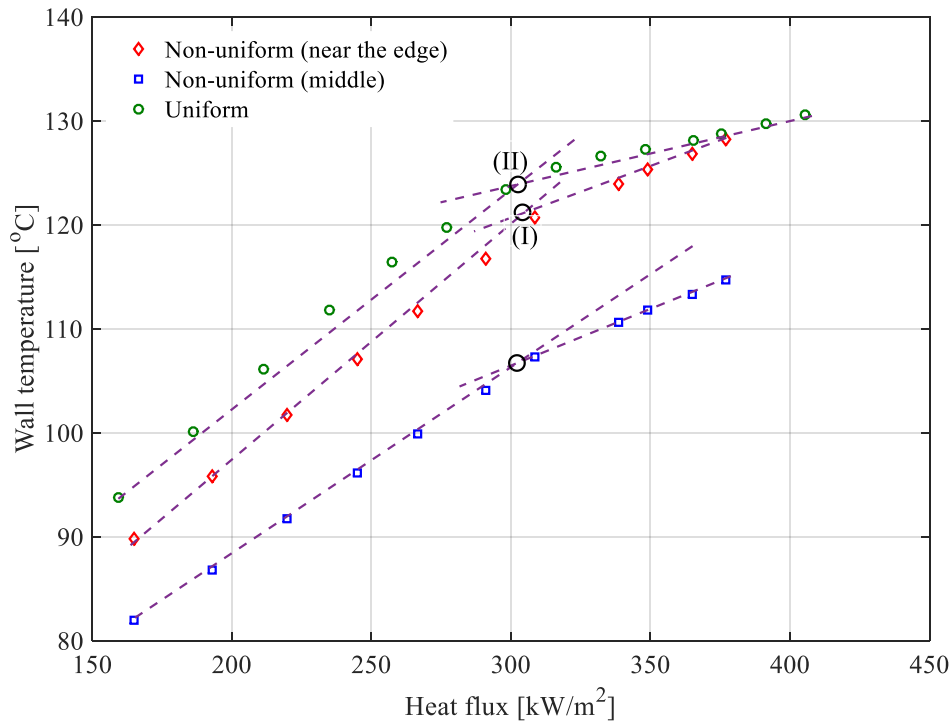

Fig8. . The ONB heat flux for the uniform and non-uniform test section, (Mass flow rate is 0.08 kg/s, Inlet temperature is 50 °C).

Since the wall temperature near the edge under non-uniform heat flux is higher than the wall temperature under uniform heat flux, the boiling can occur at relatively low thermal power under non-uniform heat flux. In all test conditions, the thermal power at ONB under non-uniform heat flux was lower than it under uniform heat flux by around 25%, as shown in Fig. 9 (a). However and as shown in Fig 9 (b), the heat fluxes at the ONB are similar.

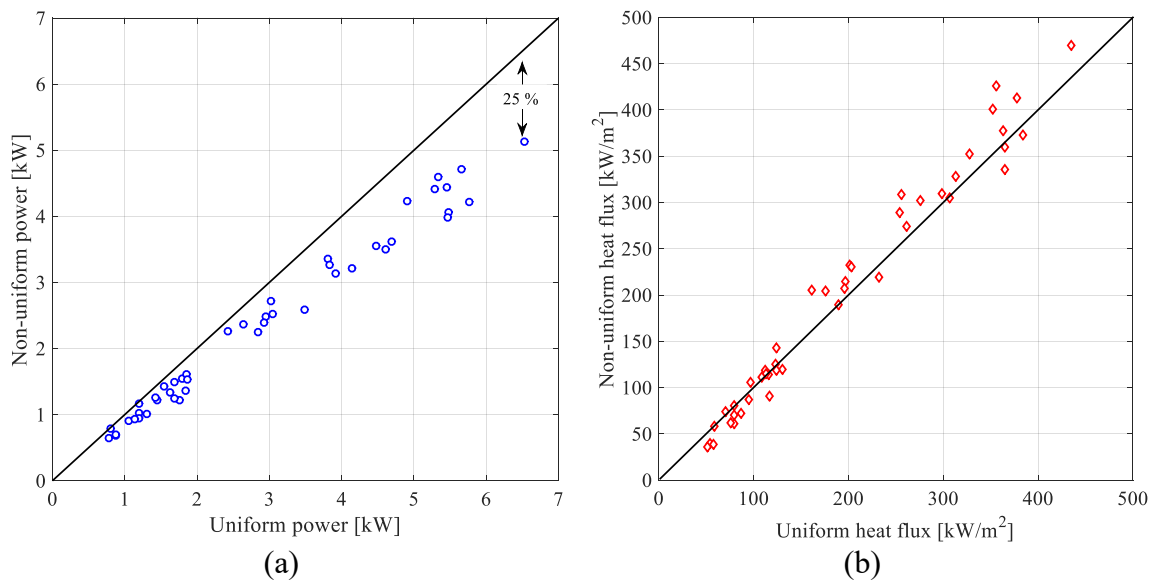

Fig. 9. The difference for ONB between uniform and non-uniform case (a) with power, (b) with heat flux



## 5.4. Onset of flow instability

The experimental results obtained at a constant mass flow rate while increasing the thermal power are illustrated in *Fig. 10*, and the experimental results obtained at a constant thermal power while decreasing the mass flux are illustrated in *Fig. 11*.

For constant power cases, the pressure drop decreases while the mass flux decreases, and it reaches its minimum value at the OFI. At that moment, the inlet pressure fluctuates owing to the flow instability. After the OFI, the pressure drop increases with the reduction in mass flux for the case of uniformly heated test section, as shown in *FIG.10 (a)*. However, the pressure drop shows different behavior after the OFI for the non-uniform case, as shown in *FIG.10 (b)*, in which it remains constant for a while and then decreases again with the increases in the bubble formation near the edges. Once the flow pattern changes to churn slug flow, the pressure drop through the flow channel increases.

Similarly for the constant mass flux cases, the pressure drop after the OFI shows different behaviors between uniform and non-uniform heat fluxes, as illustrated in *FIG.11*. In the uniform case, the inlet pressure fluctuated as the pressure drop rapidly increased with an increase in the thermal power. Thus, the flow across the coolant channel became unstable. However in the non-uniform case, the pressure drop reaches its maximum value at the OFI, whereas the inlet pressure fluctuates. After the OFI, the pressure drop suddenly decrease with the increases of thermal power, as shown in *FIG.11 (b)*. The differences in the pressure drop behavior is related to the different bubble dynamics between uniform and non-uniform heat flux. For uniform case, the bubbles are equally generated on the heated surface, and the local velocity in the lateral direction almost similar due to the similarity in the bubbles behavior. However in the non-uniform case, the bubble velocity and bubble generation rate near the edges than the middle, which may affect to the flow velocity profile in the lateral direction.

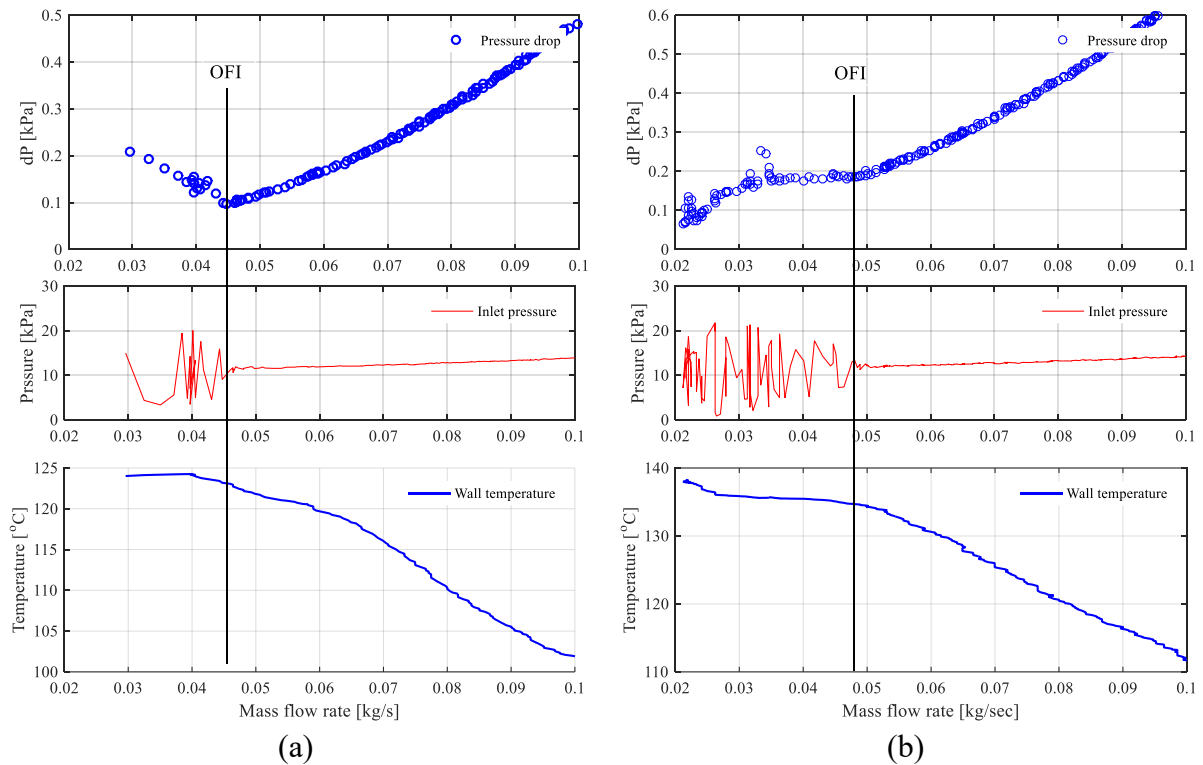

*Fig. 10. Thermal hydraulic parameters under constant power (Power 3.57 kW, inlet Temperature 50°C); (a) uniform heated case, and (b) non-uniform heated case*

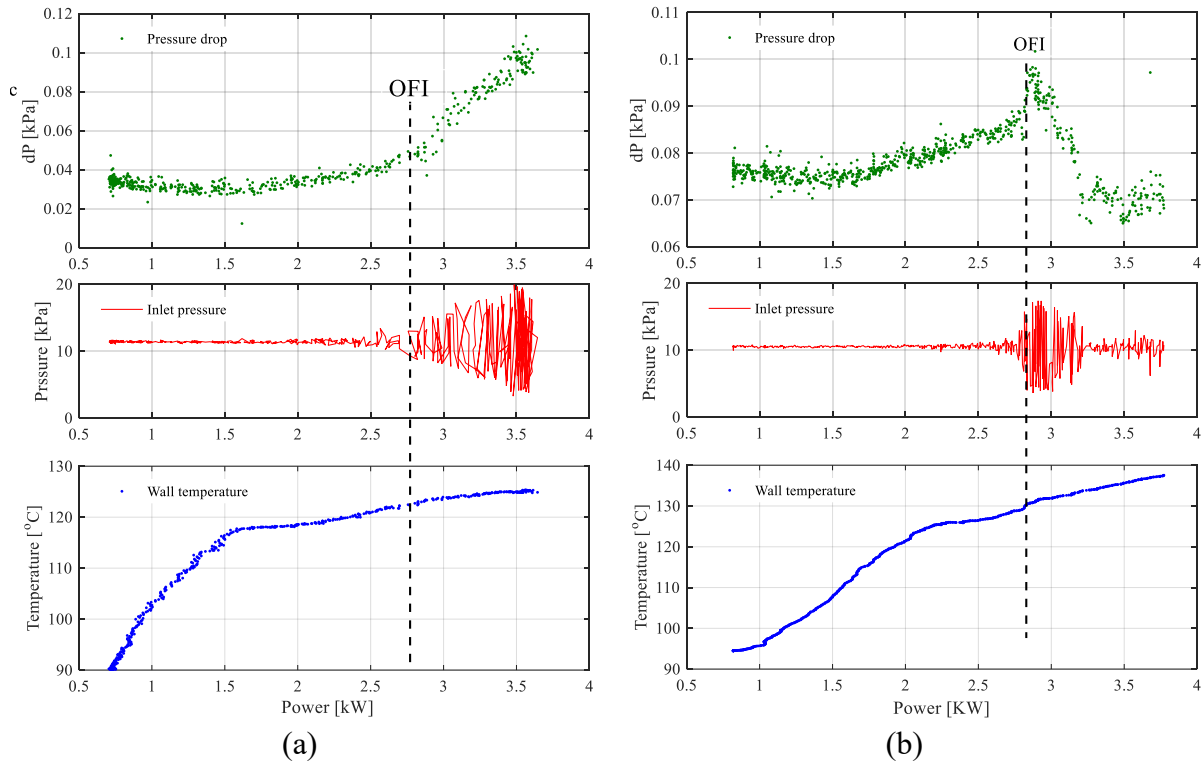

Fig.11 Thermal hydraulic parameters under constant Mass flow rate (Mass flow rate 0.03 kg/s, inlet Temperature 50°C); (a) uniform heated case, and (b) non-uniform heated case

OFI is global phenomena rather than local as ONB. Thus, the OFI are almost same for uniform and non-uniform heat fluxes, as shown in FIG.12. Although the pressure drop is different, the inlet pressure fluctuation conditions are same.

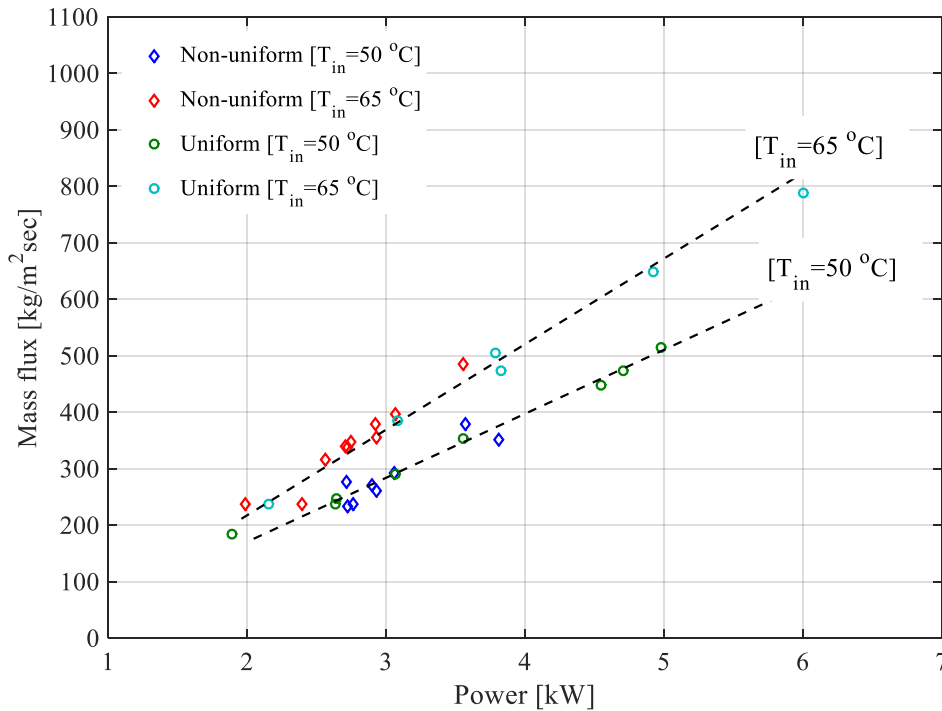

Fig. 12. The differences in the OFI between uniform and non-uniform heat fluxes

## 6. Conclusion

- (a) The effect of transversely heat flux distribution on the ONB and OFI is experimentally investigated through a narrow rectangular channel heated from one-side.
- (b) At the same total power, the local heat flux of the non-uniformly heated surface is much higher than the one in the uniform case.
- (c) ONB is local phenomena, it occurs at the same heat fluxes and wall temperature, even though the thermal power in the case of non-uniform heat flux is around 25 %less that the one in uniform case.
- (d) OFI is global phenomena. Whatever the heat flux distribution, OFI occurs at similar thermal power and mass fluxes for the same operation conditions.
- (e) The differences in the heat flux distribution leads to generate different bubble behavior, in which the pressure drop behavior is deferent between uniform and non-uniform heat fluxes.

## References

- [1] Bergles, A.E., and Rohsenow, W.M., “The Determination of Forced Convection Surface Boiling Heat Transfer”, ASME J. Heat Transfer 86 (1964) 365–372.
- [2] Lee, J., et al., “The Characteristics of Premature and Stable Critical Heat Flux for Downward Flow Boiling at Low Pressure in a Narrow Rectangular Channel”, Experimental Thermal and Fluid Science 69 (2015) 86-98.
- [3] Al-Yahia, O.S., and Jo, D., “Onset of Nucleate Boiling for Subcooled Flow through a One-Side Heated Narrow Rectangular Channel”, Annals of Nuclear Energy 109 (2017) 30-40.
- [4] Al-Yahia, O.S., and Jo, D., “ONB, OSV, and OFI for Subcooled Flow Boiling Through a Narrow Rectangular Channel Heated on One-Side”, International Journal of Heat and Mass Transfer 116 (2018) 136-151.
- [5] Jo, D., and Seo, C.G., “Effects of Transverse Power Distribution on Thermal Hydraulic Analysis”, Progress of Nuclear Energy 81 (2015) 16-21.
- [6] Al-Yahia, O.S., et al., “Effect of Transverse Power Distribution on the ONB Location in the Subcooled Boiling Flow”, Annals of Nuclear Energy 100 (2017) 98-106.
- [7] Al-Yahia, O.S., et al., “Experimental Study Of Uniform And Non-Uniform Transverse Heat Flux Distribution Effect on The Onset of Nucleate Boiling”, Proceedings of the 25th International Conference on Nuclear Engineering ICONE25 May 14-18, 2017, Shanghai, China.