

# Smart World, Ubiquitous Intelligence, Smart Hyperspace & UbickKids Study

Jianhua Ma

MUSE Lab

(Multimedia Ubiquitous Smart Environment)

CIS, Hosei University, Japan

<http://cis.k.hosei.ac.jp/~jianhua/>

## Contents – Three Topics

---

- Topic 1 - Vision
  - Ubiquitous Intelligence and Smart World + Smart Things
- Topic 2 - View
  - Smart Space and Smart Hyperspace
- Topic 3 - Research
  - **UbickKids**: A smart hyperspace of **Ub**iquitous **care** for **Kids**

# IDC – Intersection of WbS, P2P & Grid

- Internet Distributed Computing (IDC) is a unified platform by common aspects of Web computing platform: Web Services, P2P, and Grid computing as well as others.

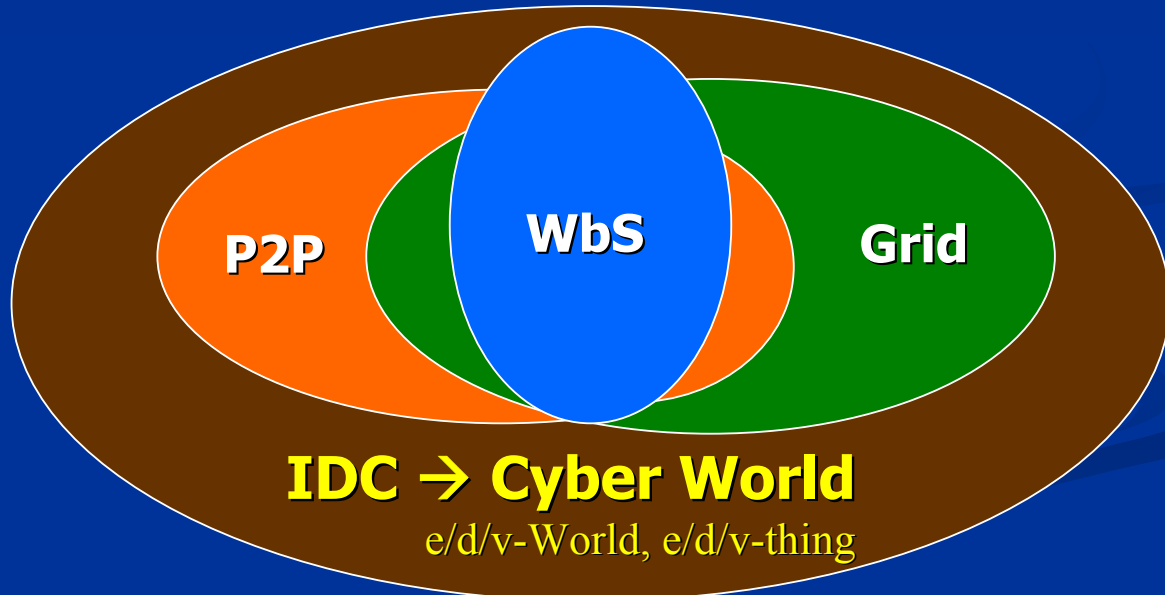

*„In the 21st century the technology revolution will move into the everyday, the small and the invisible...”*

Mark Weiser (1952 – 1999), XEROX PARC

- Small, lightweight, cheap, mobile processors and sensors
  - in almost all everyday objects („embedded computing“)
  - on your body („wearable computing“)
  - embedded in the environment („sensor networks“)

UC/Ubicomp/Percomp → Real World  
→ Real Object, Human, Environment  
through Computer/Network  
Attachment, Embedment, Blending

# Relations of Computing and Worlds

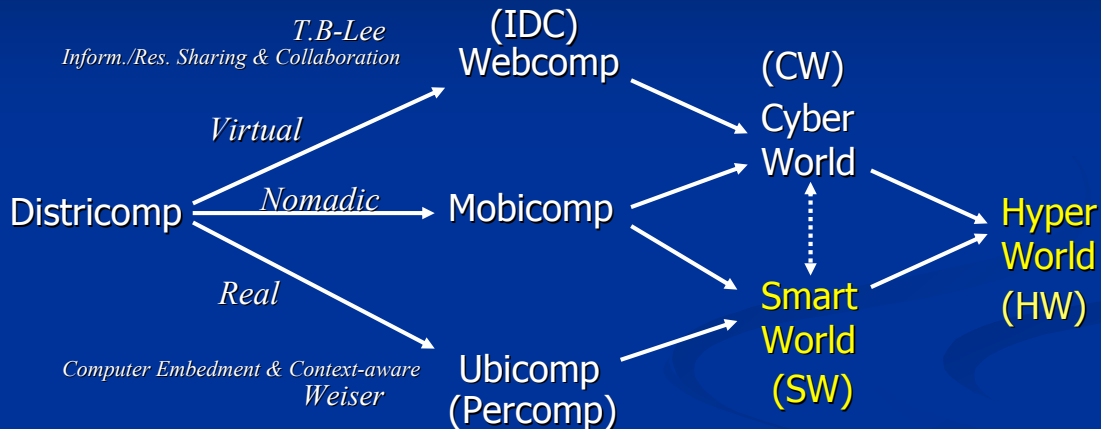

- *Hyperworld Modeling (written in 95, a keynote in VIS'96, Feb.)*
- *Modeling Interface with a Multimedia Hyperworld, HIS'96, Oct.*
- *A Study on a Hyperworld System of One-to-Many Interaction", ICAI'97*
- *Towards Direct Mapping bet. Information Worlds & Real Worlds, LNCS1306/1997*
- *International Conference on Cyber Worlds (co-founder, since 2002)*
- *1<sup>st</sup> Workshop on Ubiquitous Smart Worlds (founder, March 2005)*

## Smart World & Ubiquitous Intelligence (UI)

- **Smart World (SW)** - physical world attached/embedded/blended with
  - Computers, electronic devices, novel materials
  - MEMS, NEMS, micro robots, computational particles
  - Wired and wireless networks
- **Ubiquitous smart/intelligent things (u-things)**
  - Thing capable of computing and communicating
  - Thing able to be connected to everything else (*Lucky, 1999*)
  - Thing behaving smartly with certain "intelligence" (*Things That Think, MIT, sOc2003*)
- **Ubiquitous intelligence (UI)** (*Pervasive Intelligence,  $\pi$* )
  - Being a ubiquitous existence not only as methods/tools (*Web Presence, Cooltown*)
  - Residing in everyday objects, environments, ourselves, ...
  - Extending to both man-made and natural things
- **Information Explosion → Intelligence Pervasion/Revolution**
  - Both "information" and "intelligence" are key elements in the future computing world.
  - The Intelligence Revolution, Interview by Wise Media, ID People Magazine, Apr./05
  - Ubiquitous Intelligence Summit 2005, <http://www.ubiquitous-intelligence.com/>, Finland
  - Journal of Ubiquitous Computing and Intelligence (EiC) <http://www.aspbs.com/juci>, USA

# Intelligent Computing Waves

- 1<sup>st</sup>: AI (Logic/KL-based)
  - Machine learning
  - NLP & Comp-Vision
  - Robot & game theory
  - Expert system
  - Knowledge/Reasoning
  - DAI & Swarm Intelligence
- 2<sup>nd</sup>: Soft/Natural Comp
  - Fuzzy logic
  - Neurocomputing
  - Evolutionary computing
  - Chaotic computing
  - Probabilistic computing
  - Biologic computing
- 3<sup>rd</sup>: Agent (Social Comp)
  - Autonomous software
  - Multi agents
  - Agent language
  - Agent negotiation & cooperation
  - Personal/social behavior
  - Web intelligence/semantics
- 4<sup>th</sup>: UI (?) (*RW semantics complexity!*)
  - Atop of the above three
  - Physical/everyday things' intelligence
  - Scale, dynamic, heterogeneous, spontaneous
  - Predictable, controllable, adaptable, manageable, ethic, ...
  - Others-aware & self-aware → *mind/spirit?*

*Workshop on Self-Aware Computer Systems  
- Chaudhri & McCarthy, SRI/DARPA, 2004*

*Knowing others is wisdom,  
knowing yourself is enlightenment. – Tao Tzu*

# Roads Towards Smart World & UI

- Universal Identification
  - RFID, E-Tag, AV/Biomedical
  - Location aware computing
- Physical & Social Awareness
  - Sensor networks
  - Context based computing
  - Privacy/trust computing
- Smart Object
  - Embedded computing
  - Wearable/augmented computing
  - Everyday computing (*Georgia Tech*)
  - Sentient computing (*AT&T*)
- Platform & Middleware
  - WS, UPnP, Jini, SLP, OSGi, ...
  - Smart-Its, T-Engine, eTRON, ...
  - Aura, Gaia,, iROS, RCSM, MetaGlue, ...
- Interface & Interaction
  - Calm technology (*Weiser & Brown*)
  - Invisible/disappear computing  
(*UoW, CMU, DARPA & EU*)
  - Palpable computing (*PalCom, EU FP6*)
  - Proactive computing (*Tennenhouse, CHI'04-P*)
- Deployment & Management
  - Sustainable pervasive comp (*SPC'04*)
  - Autonomic computing (*IBM, ICAC-04*)
  - Organic computing (*GI-Workshop'04, ARCS*)
- Model & Design
  - Massive multi agent (*MMAS'04, Kyoto*)
  - CW Axioms & Cellular Modeling (*Kunii*)
  - Amorphous computing (*MIT*)
  - Spray computing (*Zambonelli*)
- Smart Space/Environment
  - Ambient intelligence (*AmI, EC*)

# Smart Things/u-things - Essential Elements in Smart World with Ubiquitous Intelligence

---

## ➤ Smart Object (smartifact)

- Single physical entity with some smartness → hard/soft/com/net/comp-ware
- *Device, card, label, e-tag, sensor, artifact, appliance, goods, furniture, textile, ....*

## ➤ Smart Space/Environment

- A physical spatial environment including smart objects &/ usual devices
- Smart services via these objects/devices and their commun./cooperation

## ➤ Smart System

- May be a real system like a network, traffic system, ...
- May be a platform middleware for a kind of smart object/environment
- May be a general one supporting a class of smart applications

## **(Future) ubicomp/percomp → computing of smart things/u-things**

See 2<sup>nd</sup> Intern. Sym. Ubiquitous Intelligence & Smart World (UISW2005, GC)

<http://www.ubiquitous-intelligence.org/conf/uisw2005>, Nagasaki, Japan, Dec. 2005

# Smartness – Challenging Real World Complexity

---

## ➤ Smart related computing terms

- "intelligent"
- *Sentient, Aware, Context-aware, Active, Reactive, Proactive, Assistive, Adaptive, Automated, Autonomic, Perceptual, Cognitive, Thinking, Selfware, ...*

## ➤ Smartness general features

- Some kind/level of intelligence, but softer, wider and flexible than "intelligence"
- From simple reactive functions to complex intelligent behaviors
- Anything from virtual to real ones, but with emphases of real/physical ones
- Felt relatively not absolutely → two co-exist facets: smart and stupid

## ➤ Ultimate Goal of UI and SW

- To make u-things behave trustworthily in context-/self-aware in some situations
- To move Ubi/PerServices from **ANY** place/time/means to **RIGHT** place/time/means

## ➤ Smartness Challenges

- Understanding real world (RW) diversity and complexity → Extremely Hard !!
- RW == physical + social + natural + ..... (uncertain, unpredictable, change, ...)
- RW abstraction, model, representation, etc. → the core base of UI & SW
- Research balance/timing between vision and feasibility at each stage
- Complicated or abstruse philosophical, culture social, ethical and other implications

# Smart Space/Environment Concept

- (2000) "The (smart) environment must be aware of the users it is interacting with and be capable of unencumbered and intelligent interaction." (by Essa, GIT)
- (2001) Ambient intelligent (AmI) is a vision where "people will be surrounded by intelligent and intuitive interfaces embedded in everyday objects around us and an environment recognizing and responding to the individuals in an invisible way". (by EU ISTAG)
- (2001) "By embedding computing infrastructure in building infrastructure, a smart space brings together two worlds .... The fusion of the worlds enables sensing and control of one world by the other." (by Satyanarayanan, CMU)
- (2002) "Active Spaces, an extension to physical spaces, capable of sensing user actions and equipped with a large variety of devices will assist users with different tasks." (by Gaia team)
- (2003) " A smart space is an environment with the numerous elements that sense + think +act + communicate + interact with people" (by CSIRO)
- (2004) "A Smart Space is a physical space rich in devices and services that is capable of interacting with people (users), the physical environment and services originated outside the Smart Space." (by M-Zones program)
- (2004) "A smart environment is one that is able to acquire and apply knowledge about an environment and also adapt to its inhabitants in order to improve their experience in that environment." (by D.J. Cook and S.K. Das, UTA)
- (2004) "Smart environments combine perceptual and reasoning capabilities with other elements of ubiquitous computing in an attempt to create a human-centered system that is embedded in physical spaces." (by H.E. Shrobe, MIT)
- **Common features**
  - Physical but digitally enhanced/integrated
  - user and surrounding aware with certain intelligence
  - better and novel services off the desktop/laptop, even beyond hand-held like PDA/mobile phone

# Smart Space/Environment Category

- |   |  |  |
|---|--|--|
| <ul style="list-style-type: none"><li>➤ <b>Classification with space functional purpose:</b><ul style="list-style-type: none"><li>■ Room, home, office, lab, classroom, etc.</li><li>■ Building, library, school, campus, factory, etc.</li><li>■ Shop, rest., hotel, clinic, hospital, etc.</li><li>■ Street, yard, park, ground, city, etc.</li><li>■ Vehicle, road, railway, station, airport, etc.</li><li>■ Land, mountain, pool, lake, river, etc.</li><li>■ ...</li></ul></li><li>➤ <b>Key Issues</b><ul style="list-style-type: none"><li>- Space/environment ontology, semantics, models and description schemes</li></ul></li></ul> | <ul style="list-style-type: none"><li>➤ <b>Classification with space spatial attribute:</b><ul style="list-style-type: none"><li>■ Small versus large</li><li>■ Enclose versus open</li><li>■ Still versus mobile</li><li>■ Shape and dimension</li><li>■ Partition and layout</li><li>■ Positions/relationships of inside objects</li><li>■ ...</li></ul></li></ul> | <ul style="list-style-type: none"><li>➤ <b>Classification with space service &amp; technology</b><ul style="list-style-type: none"><li>■ Private versus public</li><li>■ Specific versus general</li><li>■ Targeted users (kids, elder, student, patient, etc.)</li><li>■ Number &amp; activities of users</li><li>■ Smart object, device, computer, ..., used</li><li>■ Networks &amp; media used</li><li>■ Context type, number, usage</li><li>■ ...</li></ul></li></ul> |
|---|--|--|

# Smart Space/Environment Principles

## ➤ (Situational) Context Awareness (Schilit et al, 1994)

A smart space/environment must take proper actions according to certain contexts – 5Ws.  
"Context is any information that can be used to characterize the situation of an entity. An entity is a person, place, or object that is considered relevant to the interaction between a user and an application, including the user and applications themselves." (Dey, 2001)

## ➤ (Spatial) Boundary Principle (Kindberg & Fox, 2002)

UbiComp system designers should divide the ubiComp world into environments with boundaries that demarcate their content. A clear boundary criterion—often, but not necessarily, related to a boundary in the physical world—should exist.

## ➤ (Temporal) Continuous Interaction (Abowd et al, 2002)

Providing continuous interaction moves computing from a localized tool to a constant presence. The emphasis on designing for continuously available interactions requires addressing these features of informal, daily activities: without a clear beginning or end, attention switch due to interruptions, concurrent multi activities, relationship changes along with time, etc.

## ➤ (Situational/Spatial/Temporal) Interrelation (Ours, 1996 & 2003)

*Hyperworld Modeling (VIS'96), Modeling Interface with a Multimedia Hyperworld (HIS'96)*

- A present situation may be related to events in the past/future probably at other spaces
- A current event may result in a sequence of follow-up events in different places/time
- A user may frequently move between different spaces in daily activities
- A user may be sometimes interested in what happen at other places in a particular time

Current status: focused on a variety of individual and isolated smart spaces but seldom or without fully addressing space interrelations !

→ Need of a smart hyperspace, a set of interrelated & connected smart spaces!

## Smart Hyperspace Example

### Pervasive Healthcare

- Spouse
- Police
- Traffic control
- Insurance Co.

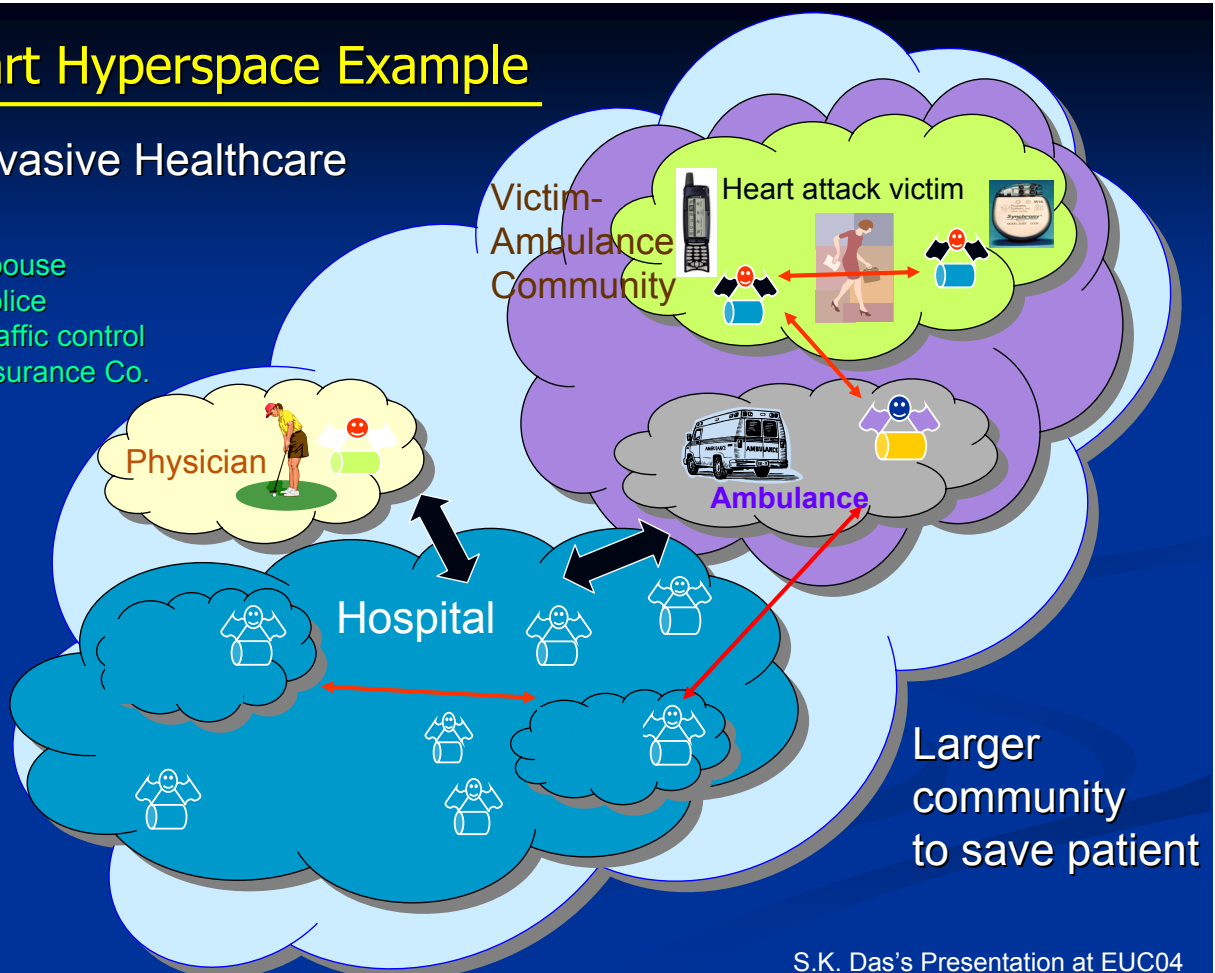

# Smart Hyperspace Issues

---

- Hyperspace abstraction and model
- Hyperspace semantics and representation
- Connections of heterogeneous smart spaces
- Context interrelations and sharing across places/time
- Smoothness of uneven spaces or space jitters (smartness differences)
- Coordination and management of associated smart spaces
- Scalability and manageability of a hyperspace
- Security, privacy, and trust in multi-spaces
- Interface and Interaction of a hyperspace
- Hyperspace network infrastructure
- Hyperspace middleware and interoperations
- Hyperspace social/economic/cultural/ethic implications and impacts
- ...

No answer yet ! The issues themselves need to be further clarified !!

Two fundamental research ways:

- General thinking and systematic theoretical study is essential
- Proper and representative practical case study is necessary

# Why A Smart Hyperspace for Kids Care

---

- Scope Criteria
  - Includes a set of different but interrelated spaces capable of being smart
  - Covers core issues related to the smart hyperspace
  - Involves both technical and non-technical factors
- Feasibility Criteria
  - Complexity controllable and improvable continuously
  - Privacy relatively acceptable and can be enhanced gradually
  - Cost is reasonable, especially in the beginning
- Other Criteria
  - Useful
  - Novel
  - Fun
- A ubiquitous kids care system likely matches the above criteria.  
A unique one comparable with Personalized Instrumented Health System for elders (PIHS, UR/MIT/GT/UF)
- A survey recently made in Japan, says that
  - 72.5% parents worried about their kids,
  - 82.3% parents felt tired in caring their kids, and
  - 91.9% parents had no enough time to satisfactorily take care of their kids.
- IT gifts to kids: toy, game, animation, what else are specially designed for them?
  - Lacks enough research and non-playable products for kids by IT
  - Interaction Design and Children (IDC, annual conference since 2002) – No kids care topics!
- Such system is not only proper for hyperspace study but valuable for a special type of users



# UbicKids – Ubiquitous Care for Kids

## ➤ UbicKids Objectives

- To develop a set of ubiquitous applications for assisting parents to take care of their kids with more convenient, prompt, reliable, precise, secure and trust services.
- To build a representative smart hyperspace for probing and researching ubiquitous hyperspace related issues, models, technologies, etc.
- To study impacts and solutions of non-technical factors to both ubiquitous systems and users, especially children, their growth, character development, etc.

## ➤ UbicKids Assumptions

- Usual family with one or more normal children (disabled, single par., grand par., ...)
- Typical spaces such as home, yard, park, street, station, car, school, office, clinic, ...
- Kids ages: ways in caring kids vary for kids in different ages, (families, cultures, ...)



## ➤ UbicKids Functions – 3A

- Kids **A**wareness: knowing kids current & past status
- Kids **A**ssistance: helping kids in doing something
- Kids **A**dvice: advising/reminding kids and parents

*Towards a Smart World and Ubiquitous Intelligence: A Walkthrough from Smart Things to Smart Hyperspaces and UbicKids*, Journal of Pervasive Comp. and Comm., 1(1), March 2005.

# UbicKids Functions & Scenarios - 3A

## Kids Awareness

### KidsWhere

- KidsInHome
- KidsInsideLocation
- KidsOutsideLocation
- KidsWhereWas

### KidsWhat

- KidsDoingWhat
- KidsWhenDidWhat
- KidsForgetWhat
- KidsWillDoWhat

### KidsState

- KidsKickCover
- KidsHealthMonitor
- KidsADHDMonitor

### KidsSurrounding

- KidsSurroundingWhat
- KidsSurroundingWhere
- KidsSurroundingRelation

.....

## Kids Assistance

### ThingsFinder

- ToyFinder
- LostGoodFinder
- ParentFinder

### ThingsNavigator

- RoadNavigator
- GameCornerNavigator

### ThingsAutoAdjustor

- ReadingLightAdjustor
- TemperatureAdjustor
- AirconWindowOpenClose

### ThingsTeleOperator

- TVProgramRecorder
- ToyTeleController

### ThingsProvider

- InformationProvider
- OutsideGuard

.....

## Kids Advice

### KidsReminder

- Key/Umbrella/ClothReminder
- GoodHabitReminder
- BackHomeReminder
- ReadPostureReminder

### KidsAdvisor

- Read/PlayTimingAdvisor
- BeQuietAdvisor
- SaftyAdvisor
- Praise&Criticism

### ParentKidsCommunicator

- JustInTimeMessage
- KidsAwarePhoneCall

### ParentsAdvisor

- GrowingRecorder
- KidsAssesment
- KidsCareRecommender

.....

# UbicKids Conceptual System Architecture

## Open Issues

- Rethinking layered model methodology → Loop?
- Modeling spaces & hyperspaces
- Universal context management & services
- Adaptable middleware/software
- Interactive *versus* proactive mechanisms

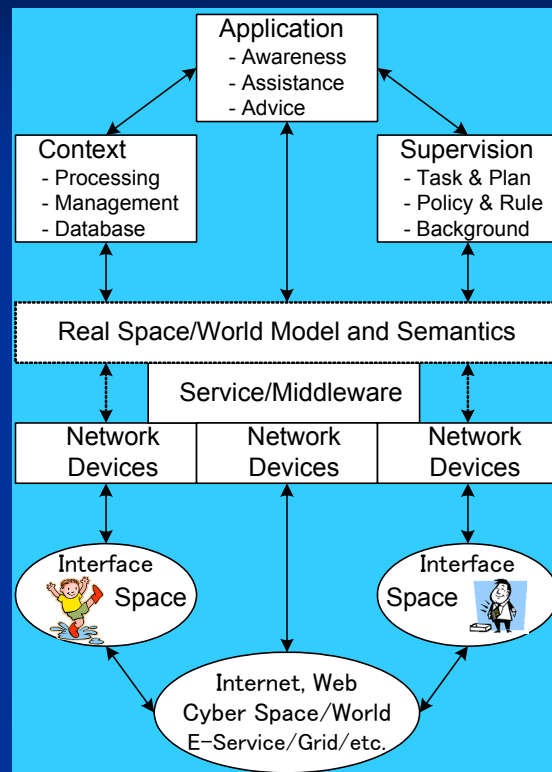

# UbicKids Conceptual Network System

## Open Issues

- A great number of devices with different purposes and functions
- Heterogeneous networks and spontaneous communications
- Gateway & general platforms (UPnP, OSGi, JAIN, OMA, OSA,...?)
- **Autonomic & Trusted** hardware, software, networks and systems

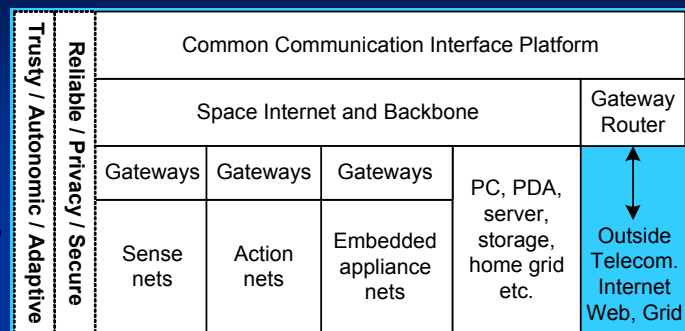

Journal of Autonomic and Trusted Computing (JoATC, EiC), American Scientific Publisher  
 Workshop on Trusted and Autonomic Ubiquitous & Embedded Systems (TAUES05, co-founder)

## Sense Nets

- Sensor net to acquire ambient contexts
- RFID net to identify objects/users
- Some net for indoor positioning
- GPS net for outdoor positioning
- Camera net to capture visual information
- Microphone net to capture audio information
- Bio-sensor net to get physiologic/medical data

## Action Nets

- Light control net
- Temperature/humid control net
- Door/window control net
- Home appliance control net
- Speaker net distributed over spaces
- Display net for connecting various displays
- Bio-actuator net

# UbickKids – Current Research

- **Modeling spaces**  
(indoor, outdoor, mobile spaces, etc.)  
(Common base for hyperspace & UbickKids application development)
- **Kids safety care**  
(A preliminary outdoor system for assisting care of kids safety)
- **Context acquisition via RFID**  
(Umbrella reminder, toy finder & others)
- **Ambient sound aware system**  
(Be Quiet advice, mic/speaker nets)
- **RFID/sensor net privacy**  
(Location privacy, family data security)
- **P2P TOMSCOP platform**  
(A general middleware for ubicomp appl.)  
V1.1(2003), V1.2(soon), 1.3(working)  
<http://malab.k.hosei.ac.jp/~tomscop/>

General system organization in current sample applications based on **interactive** mechanism

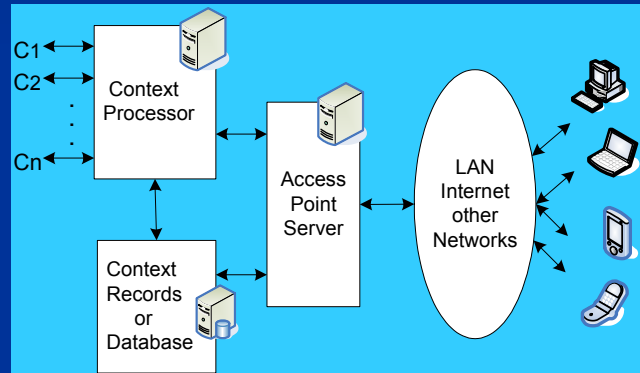

Future one will emphasize on the **proactive** mechanism

# UbickKids – Current Research (Cont.)

## Object Finder →

- toy
- game
- key
- ...

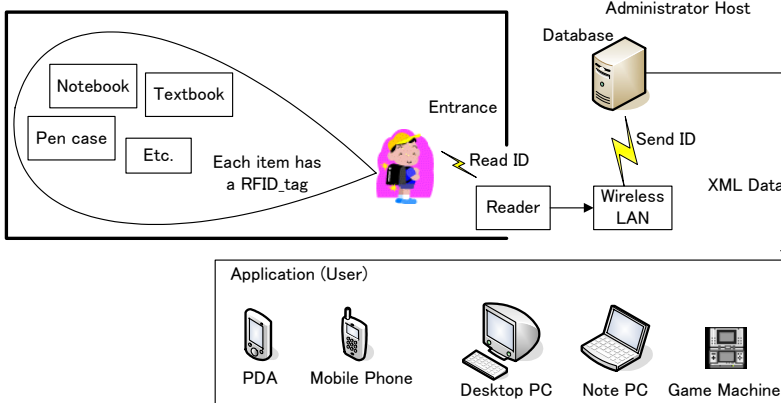
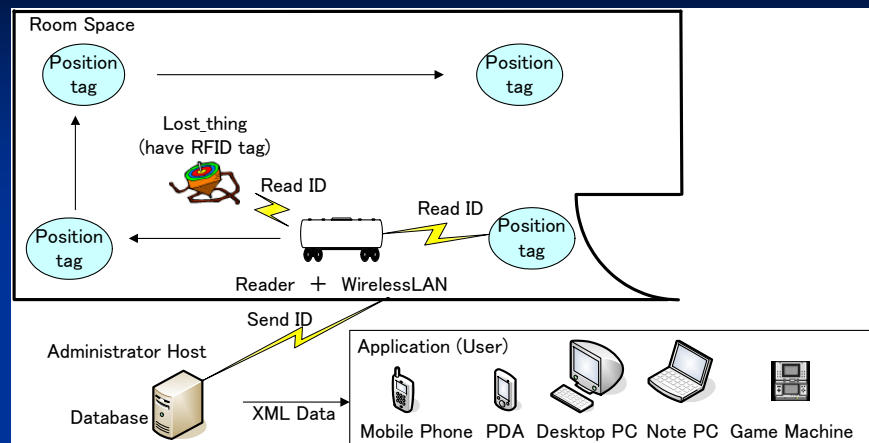

## ← Thing Reminder

- umbrella
- book
- pencil
- ...

# UbicKids – Current Research (Cont.)

## RFID-based Administration System →

- child
- student
- employee
- ...

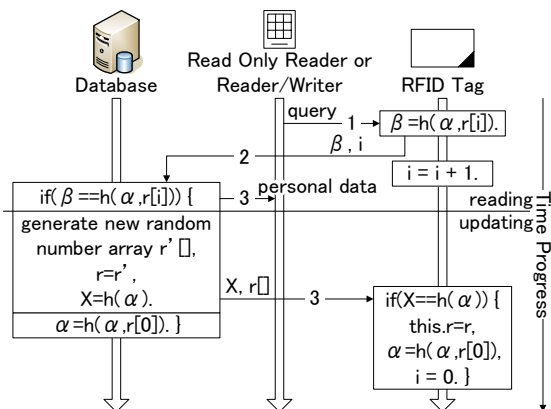
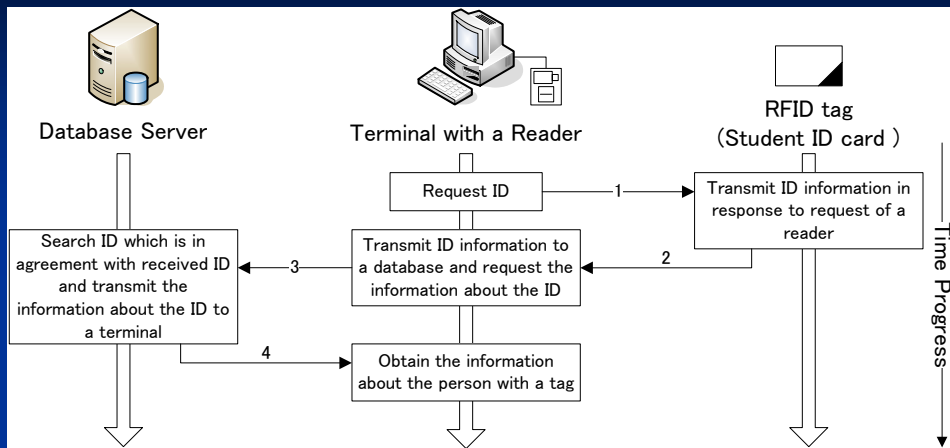

← A Random ID Update Scheme to Protect User Location Privacy

Performance →

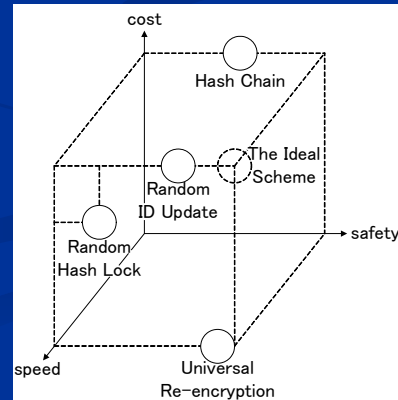

# UbicKids – Current Research (Cont.)

## Sound Disturbance →

- home
- classroom
- theater
- ...

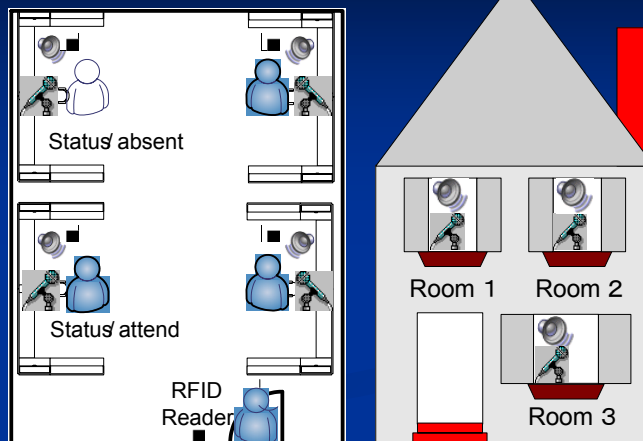
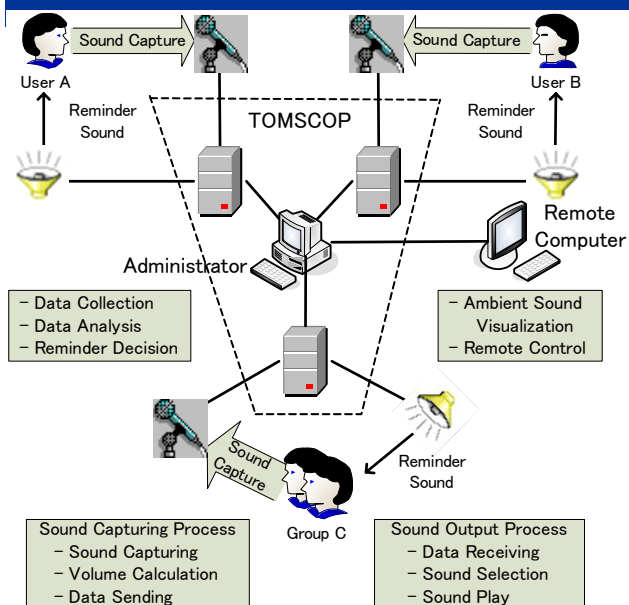

## ← Be Quiet Advice Prototype

- Ambient sound capture
- Ambient analysis
- Advice judgment
- Advice presentation
- ...

# UbicKids – Current Research (Cont.)

## Safety Care →

- school route
- play in outside
- fire, traffic, etc.
- ...

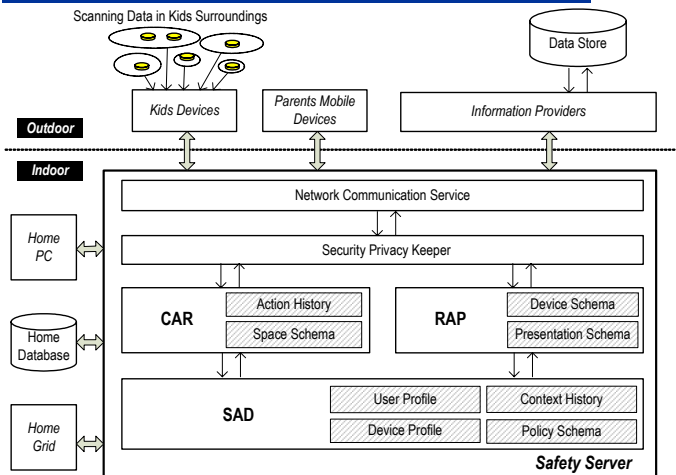
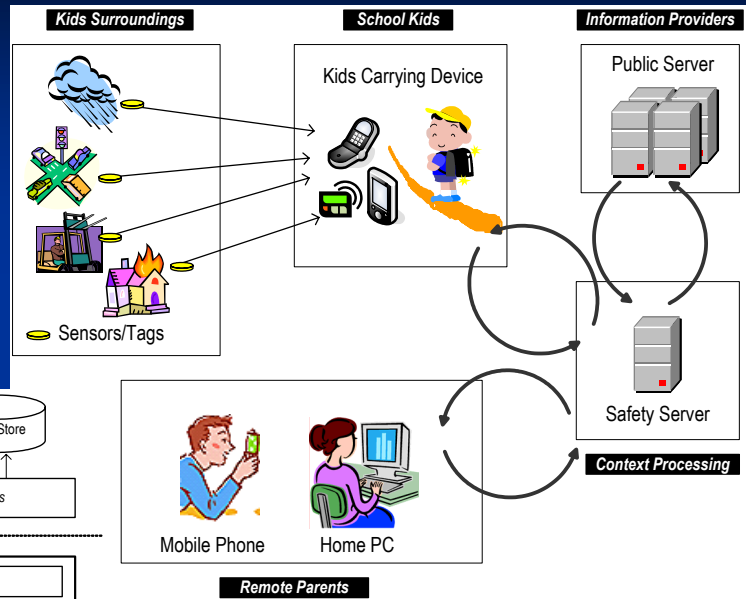

## ← Outdoor Safety Care System

- Context Acquisition & Representation
- Situation Analysis & Decision
- Response Action & Presentation
- Model, Schema, Intelligence, ...

# UbicKids - Non-Technical Factors

## Double-edged Sword

- Seamless integrations of physical and digital world,
  - “a strange new world” (by Mattern, 2004)
- Kids learn from everyday interactions with the environments
  - help forming their characteristics, behaviors, habits, personalities etc.,
  - influence their whole lives.
- A truly useful UbicKids system
  - full considerations on non-technical factors, i.e., human, society, culture, physiology, psychology, moral, feeling, etc.
- Positive and negative impacts to kids
  - be seriously investigated
  - solutions must be discovered to overcome the negative aspects.

## Non-Technical Factors

- Common characteristics shared by many kids
- Special characteristics for individual kids
- Characteristic changes along with growing kids
- Relationships and roles of family members
- Features of kids care activities
- Heterogeneity in kids care
- Cultures and laws in kids care
- Psychological behavior in a smart space
- Child’s personality development
- Child’s habit and moral cultivation
- Child’s independence improvement
- Child’s intelligence increase
- Feeling/love enhancement of parents-kids
- Special care to disabled/incapacitated children
- Family of single parent, with nurse, etc.
- ...

# Final Remark

---

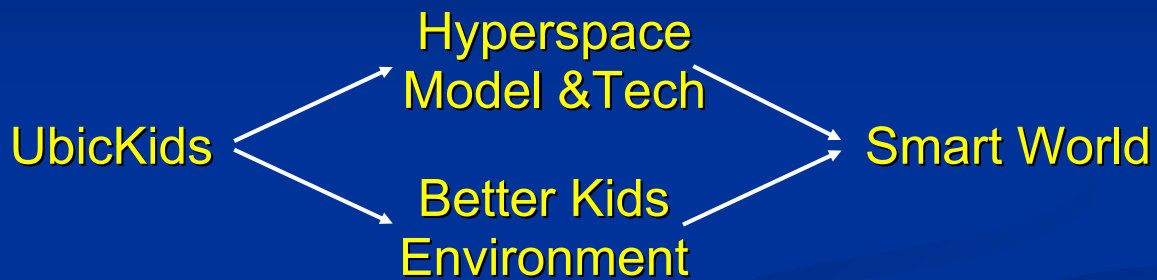

*From e/virtual to real, from cyber world to smart world!  
From desktop to environment, from space to hyperspace!  
Knowing more the children, know more the world!  
The betterment of children, the better world!*

# Final ...

---

Oh sorry!

I forgot some special "kids": dog, cat, ... (pets!)  
→ UbicPets, Ubic~ ?

What else are missed? → Ubi~, Ubi~, Ubi~, ... ?  
e-, e-, ... → m-, m-, ... → u-, u-, u-, u-, u-, ... ?  
→ p-, p-, p-, p-, p-, ... ?  
→ s-, s-, s-, s-, s-, ... ?  
→ i-, i-, i-, i-, i-, ... ?  
→  $\varepsilon + \infty$ , ... ? ? ? ? ? ?

Send your ideas and comments to [jianhua@k.hosei.ac.jp](mailto:jianhua@k.hosei.ac.jp)