

# AUGMENTED REALITY IN YOUR WEB PROXY

[Roberto Suggi Liverani](#) - [@malerisch](#)

ISC(2) / OWASP Belgium Chapter

Leuven – 17 December 2013

# Who am I?

- ◉ A guy who likes to find bugs 😊
- ◉ Speaker at various cons/events:
  - Hack in the Box, DefCON, EUSecWest, OWASP, HackPra AllStars
- ◉ OWASP New Zealand Founder
- ◉ Twitter: [@malerisch](https://twitter.com/malerisch)
- ◉ Research blog: [blog.malerisch.net](http://blog.malerisch.net)

# Outline

- ⦿ Challenges / Solutions
- ⦿ Introducing Burp CSJ / DEMOs
- ⦿ Stories
- ⦿ Conclusions / Future plans

# Traditional testing approach



# The concept of proxy suite



Web Proxy Suite

Intruder

Spider

Scanner

Repeater



Web App

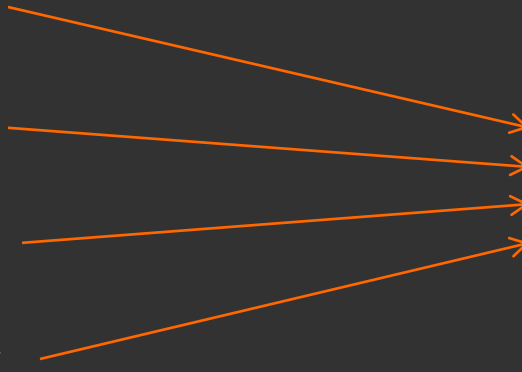

# The problem is...

*Web proxy originally design to focus on server-side technology*



Web App



Web Proxy



Web App



Browser

*Client-side technology shift  
A web app is designed to be used by a browser*

# Combining technologies

- How can we get a browser close to a web proxy or vice versa?

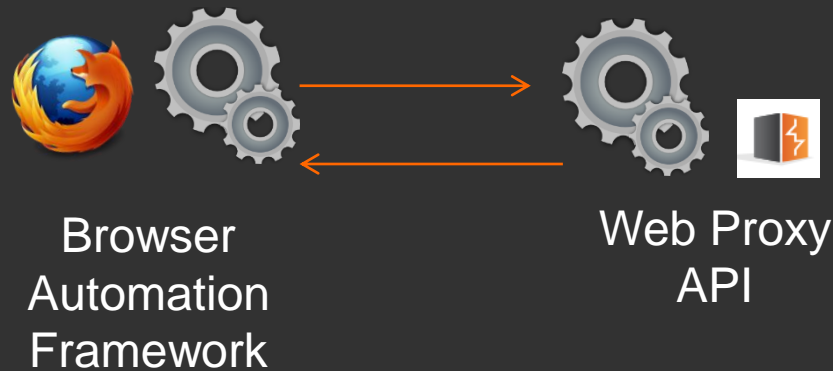

# So what do we achieve?





# Browser automation options...

- ⦿ Selenium

- Browser automation framework



- ⦿ Crawljax

- Crawler for Ajax apps based on Selenium

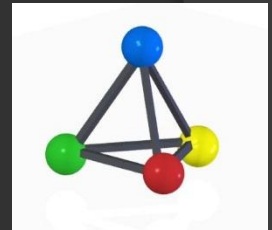

- ⦿ JUnit

- Testing framework

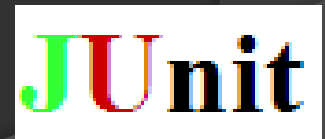

# Selenium Server



- Integrates Selenium RC
- Launches and kills browsers
- Interprets and runs Selenese commands
- Supports Grid and nodes
- Known as:
  - selenium-server-standalone
  - selenium-server

# Selenium Client & WebDriver

- Based on WebDriver wire protocol – RESTful + JSON
- Direct calls to browser
- Multiple drivers available: Chrome, IE, Opera, Android, iPhone
- Known as selenium-java



# Selenium IDE

- Create/Repeat Execute Test case
- Firefox addon
- Export to various formats  
JUnit  
WebDriver

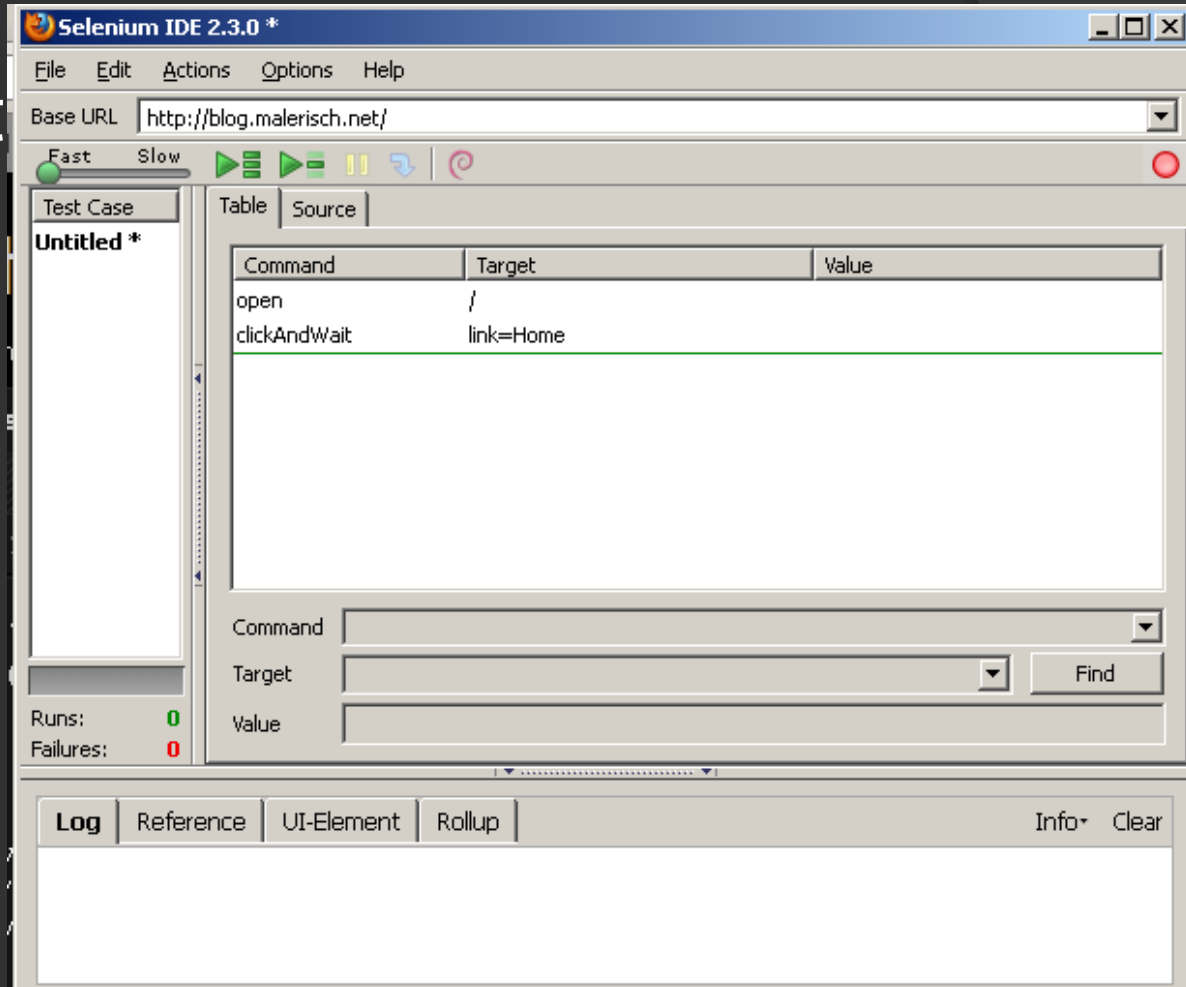

# Crawljax

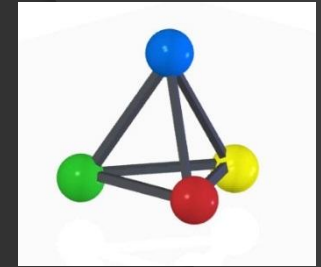

- Based on Selenium WebDriver APIs
- State-flow interpretation of DOM states

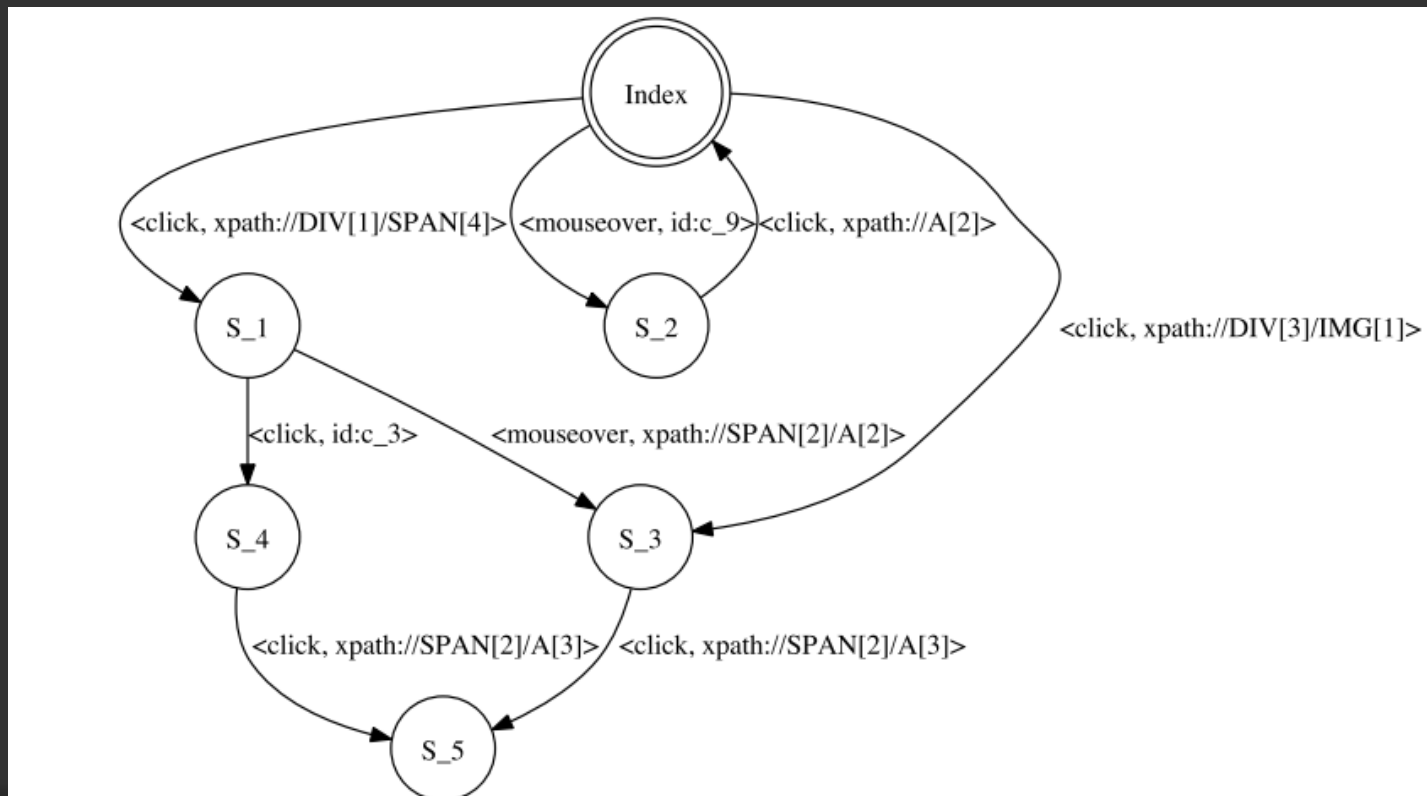

Fig. 2. The state-flow graph visualization.

# Crawljax

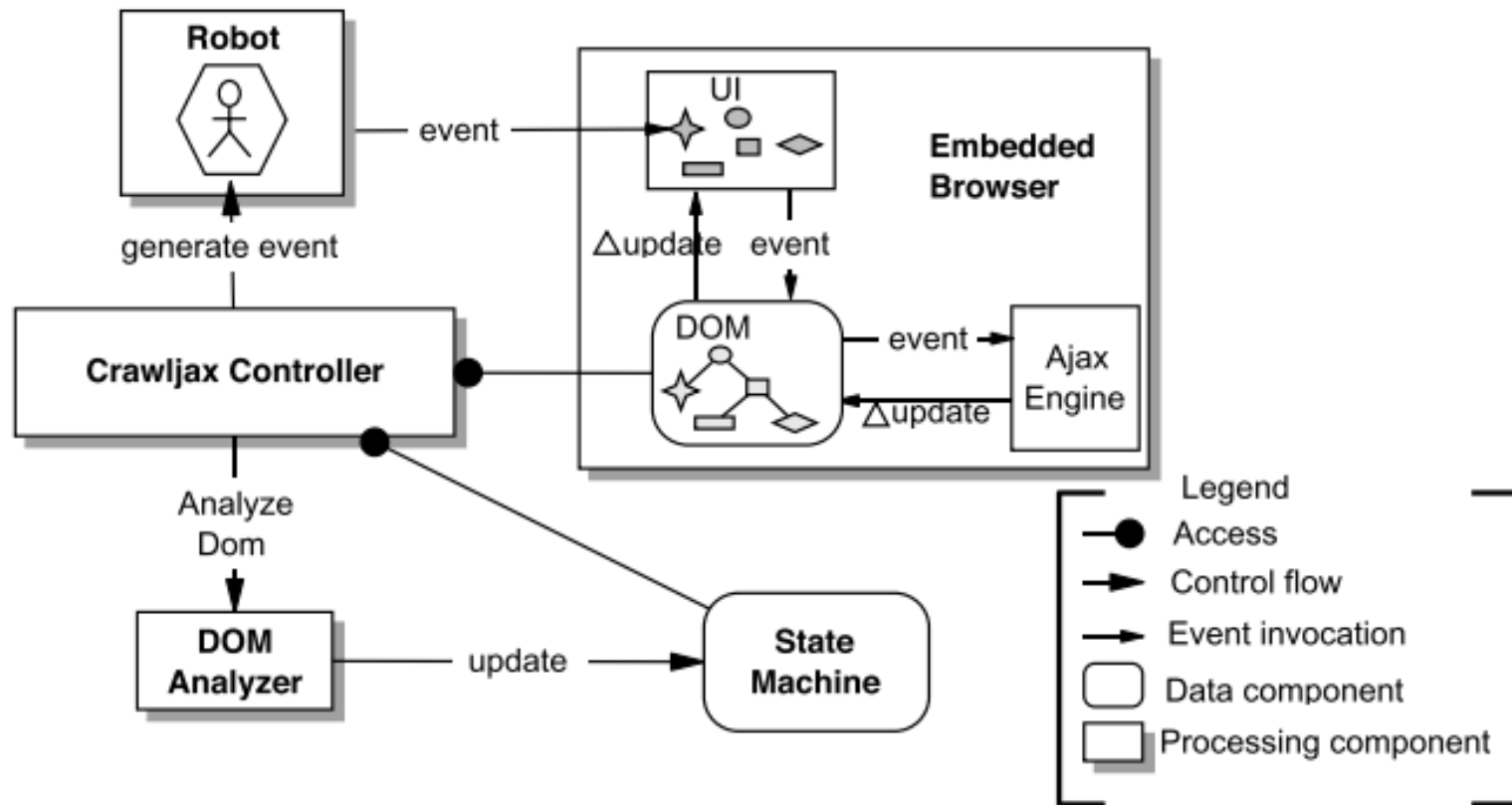
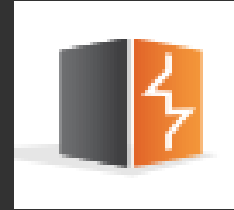

Fig. 3. Processing view of the crawling architecture.

# Web proxy options...

## ⦿ Burp Extender API

- Java/Python/Ruby
- Scanner, Proxy, Repeater, Cookie, Target Session handling, HTTP requests/responses



## ⦿ ZAP API

- REST interface
- Spider, core, params, ascan, context auth, acsrf, autoupdate, pscan



# Crawljax - Pros



## Why integrate Crawljax?

- ⦿ Augmented reality in your proxy
- ⦿ Increased coverage for complex web apps
- ⦿ Scalability with big/dynamic apps
- ⦿ Integrated in ZAP - Ajax Spider  
@GuifreRuiz - very cool work! 😊



# JUnit - Pros



## Why use JUnit?

- ⦿ Increase chances to discover hard-to-find bugs
- ⦿ Easily create repeatable sequence of steps
- ⦿ Reuse existing JUnit test-case
- ⦿ Leverage Burp macro capability

# So how to combine all this?

- Created a burp extension (Burp CSJ)
  - Integrates Crawljax
  - Integrates JUnit test-case created via Selenium IDE

Source: <https://github.com/malerisch/burp-csj>



*Coded in Java using google, stackoverflow, a mix of guessing , luck and a lot of swearing...*

# How it works...

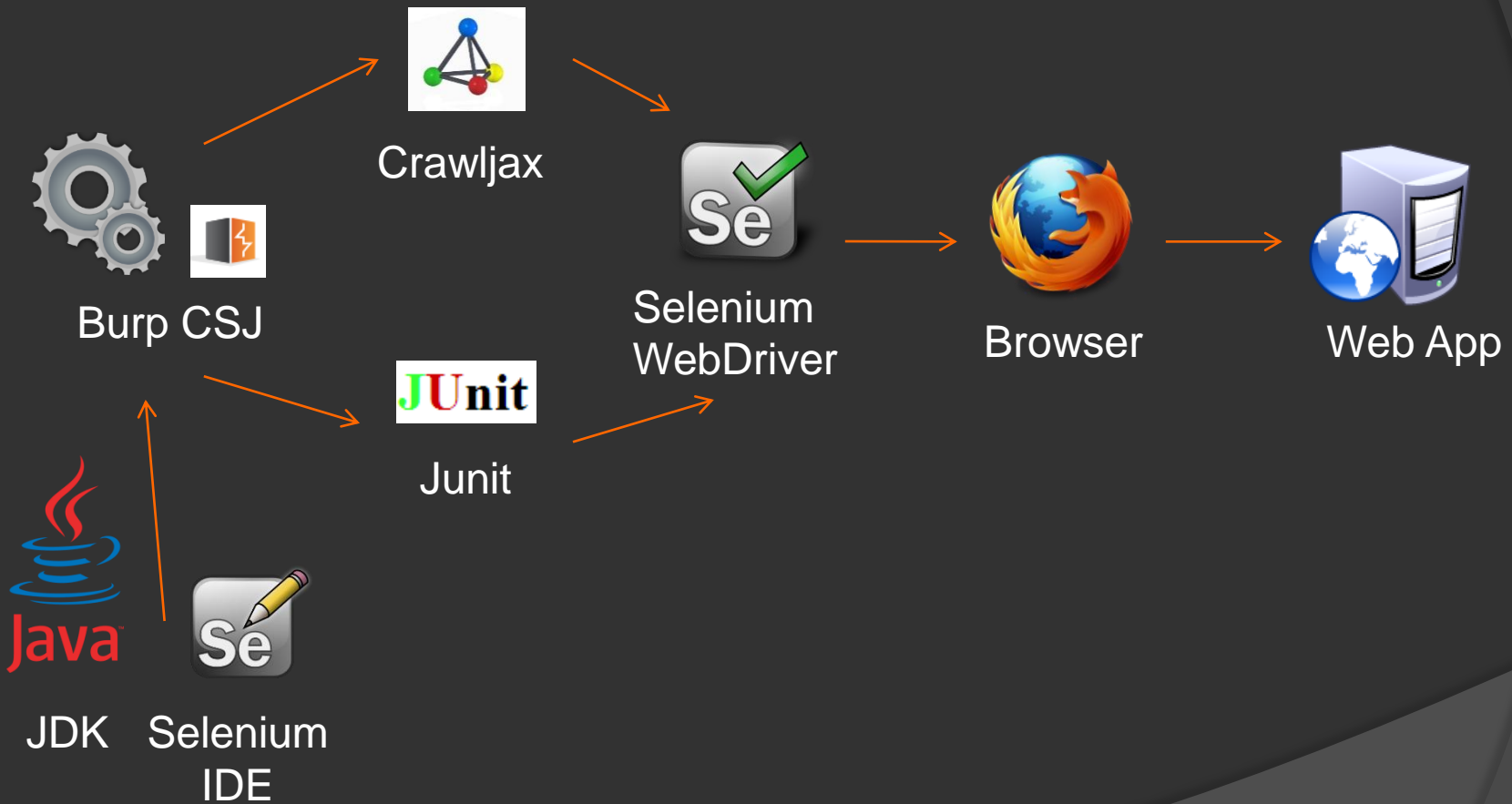

# Crawljax integration

## ◎ Key Features

- Support for Burp cookie jar
- Support for multiple browsers, including remote webdriver
- Support for multiple HTML elements
- Exclusion list for crawling
- Support for CrawlOverview plugin

# Crawljax Tab (1/3)

## Generic Settings

Browser

Instances

### Proxy Type

Use System Proxy Settings

Use Manual Proxy

## Configured Browsers

Remote

Chrome

IE

PhantomJS

# Crawljax Tab (2/3)

## Advanced Options

Use Burp CookieJar

Click Once

Insert Random Input On Forms

Crawl Hidden Anchors

Crawl Frames

Wait After Reload URL

Wait After Event

Maximum Depth

Maximum States

Max Runtime (mins)

Add

Remove

Exclusion

exit

signout

signoff

logoff

logout

# Crawljax Tab (3/3)

## Crawl Elements

- A
- INPUT
- XHR
- SELF
- BUTTON
- OPTION
- REFRESH
- TD
- IMG
- META
- SPAN
- LINK
- RELATIVE
- DIV
- P
- NON
- FORM
- SELECT
- RADIO
- TR
- OL
- LI

## Plugins

- No Plugins
- Overview Plugin

Choose folder

# DEMO

- ◉ Crawling a site with auth
- ◉ Crawling a site with auth + remote web driver
- ◉ DEMOs
- ◉ <https://www.youtube.com/watch?v=x51jwZ1HV9E>
- ◉ <https://www.youtube.com/watch?v=X3mjheLJEFE>



# JUnit Integration

## ◎ Key Features

- Import compiled Selenium IDE JUnit Test cases
- Register test-case into Burp session handling
- Test case can be invoked in the Macro editor
- Interface to execute Junit test case

# JUnit Tab

## JUnit Integration

Example: C:\test\Test1.class - Class Path: file://C:/ - Full class name: test.Test1

Add

Remove

Register

Execute

Class Path	Full Class Name	Description Name	Registered
file://C:/	test.Test1		<input type="checkbox"/>

# DEMO

- ⦿ Launching JUnit test-case via Burp Proxy
- ⦿ Registering Junit Test-case via Burp and setting a macro
- ⦿ DEMO:  
<https://www.youtube.com/watch?v=mKOD3ysiN-U>

# Burp CSJ Tips

- Use Burp Spider + Crawljax for crawling and after scanning/attacking application
- Create JUnit test cases for sequence which takes long time to repeat
- Set Burp macro to use precisely JUnit test case
- When using Junit with Burp CSJ, set the Cookie: header with Burp

Stories from the automation world...

# base64 and command injection

- ⦿ Crawljax clicked on some pages with base64 data
- ⦿ A scan was run before
- ⦿ Some of those pages content was decoded
- ⦿ Trace of ping command output were found
- ⦿ An indirect OS command injection was found!

# jQuery, toggle() and XSS 😊

- ⦿ Complex app – use of jQuery
  - Lot of clickable elements which would invoke toggle()
- ⦿ Crawljax clicked element
- ⦿ New page added to Burp Target
- ⦿ Page vulnerable to XSS

# A nice shopping cart!

- ⦿ Vulnerable shopping cart
  - Special product item would decrease amount
- ⦿ Sequence of steps had to be performed before
- ⦿ JUnit test-cases made the difference



# Conclusions

- ⦿ Combining automation is a different type of testing
  - Time for preparation needed
  - Not ideal for testers looking for quick wins
- ⦿ ROI is always in bugs discovery
  - ... especially bugs with critical severity

# Burp CSJ future

- ◎ Resolve github tickets!
- ◎ Expand Crawljax integration
  - Support plugin import feature
- ◎ Expand JUnit Integration
  - Compile from Java Source directly...
  - Also change browser set in Junit test case...
  - Support for Burp cookie jar

# Questions?

Roberto Suggi Liverani - [@malerisch](https://twitter.com/malerisch)  
[blog.malerisch.net](http://blog.malerisch.net)

- ◉ Source Code: <https://github.com/malerisch/burp-csj>
- ◉ Tutorial: <http://blog.malerisch.net/2013/09/burpcsj-tutorial-using-crawljax.html>

# References

- ⦿ Blog – Roberto Suggi Liverani
  - <http://blog.malerisch.net/>
- ⦿ Twitter account - @malerisch
  - <https://twitter.com/malerisch>
- ⦿ Crawling AJAX-Based Web Applications through Dynamic Analysis of User Interface State Changes
- ⦿ <http://www.ece.ubc.ca/~amesbah/docs/tweb-final.pdf>

# References

- ◎ Crawljax
  - <http://crawljax.com/>
- ◎ Selenium
  - <http://docs.seleniumhq.org/>
- ◎ JUnit
  - <http://junit.org/>

# References

## ⦿ Burp Extender API

- <http://portswigger.net/burp/extender/api/index.html>

## ⦿ ZAP API

- <https://code.google.com/p/zaproxy/wiki/ApiDetails>

## ⦿ Ajax spider in ZAP

- [https://code.google.com/p/zaproxy/wiki/GSoC2012\\_PluginACT](https://code.google.com/p/zaproxy/wiki/GSoC2012_PluginACT)