

# INSTRUCTION MANUAL



## LI190SB Quantum Sensor

Revision: 2/15



Copyright © 1982-2015  
Campbell Scientific, Inc.



# ***Limited Warranty***

---

“Products manufactured by CSI are warranted by CSI to be free from defects in materials and workmanship under normal use and service for twelve months from the date of shipment unless otherwise specified in the corresponding product manual. (Product manuals are available for review online at [www.campbellsci.com](http://www.campbellsci.com).) Products not manufactured by CSI, but that are resold by CSI, are warranted only to the limits extended by the original manufacturer. Batteries, fine-wire thermocouples, desiccant, and other consumables have no warranty. CSI’s obligation under this warranty is limited to repairing or replacing (at CSI’s option) defective Products, which shall be the sole and exclusive remedy under this warranty. The Customer assumes all costs of removing, reinstalling, and shipping defective Products to CSI. CSI will return such Products by surface carrier prepaid within the continental United States of America. To all other locations, CSI will return such Products best way CIP (port of entry) per Incoterms ® 2010. This warranty shall not apply to any Products which have been subjected to modification, misuse, neglect, improper service, accidents of nature, or shipping damage. This warranty is in lieu of all other warranties, expressed or implied. The warranty for installation services performed by CSI such as programming to customer specifications, electrical connections to Products manufactured by CSI, and Product specific training, is part of CSI’s product warranty. **CSI EXPRESSLY DISCLAIMS AND EXCLUDES ANY IMPLIED WARRANTIES OF MERCHANTABILITY OR FITNESS FOR A PARTICULAR PURPOSE. CSI hereby disclaims, to the fullest extent allowed by applicable law, any and all warranties and conditions with respect to the Products, whether express, implied or statutory, other than those expressly provided herein.”**

# Assistance

---

Products may not be returned without prior authorization. The following contact information is for US and international customers residing in countries served by Campbell Scientific, Inc. directly. Affiliate companies handle repairs for customers within their territories. Please visit [www.campbellsci.com](http://www.campbellsci.com) to determine which Campbell Scientific company serves your country.

To obtain a Returned Materials Authorization (RMA), contact CAMPBELL SCIENTIFIC, INC., phone (435) 227-9000. After an application engineer determines the nature of the problem, an RMA number will be issued. Please write this number clearly on the outside of the shipping container. Campbell Scientific's shipping address is:

**CAMPBELL SCIENTIFIC, INC.**

RMA# \_\_\_\_\_  
815 West 1800 North  
Logan, Utah 84321-1784

For all returns, the customer must fill out a "Statement of Product Cleanliness and Decontamination" form and comply with the requirements specified in it. The form is available from our web site at [www.campbellsci.com/repair](http://www.campbellsci.com/repair). A completed form must be either emailed to [repair@campbellsci.com](mailto:repair@campbellsci.com) or faxed to (435) 227-9106. Campbell Scientific is unable to process any returns until we receive this form. If the form is not received within three days of product receipt or is incomplete, the product will be returned to the customer at the customer's expense. Campbell Scientific reserves the right to refuse service on products that were exposed to contaminants that may cause health or safety concerns for our employees.

# Precautions

---

**DANGER — MANY HAZARDS ARE ASSOCIATED WITH INSTALLING, USING, MAINTAINING, AND WORKING ON OR AROUND TRIPODS, TOWERS, AND ANY ATTACHMENTS TO TRIPODS AND TOWERS SUCH AS SENSORS, CROSSARMS, ENCLOSURES, ANTENNAS, ETC.** FAILURE TO PROPERLY AND COMPLETELY ASSEMBLE, INSTALL, OPERATE, USE, AND MAINTAIN TRIPODS, TOWERS, AND ATTACHMENTS, AND FAILURE TO HEED WARNINGS, INCREASES THE RISK OF DEATH, ACCIDENT, SERIOUS INJURY, PROPERTY DAMAGE, AND PRODUCT FAILURE. TAKE ALL REASONABLE PRECAUTIONS TO AVOID THESE HAZARDS. CHECK WITH YOUR ORGANIZATION'S SAFETY COORDINATOR (OR POLICY) FOR PROCEDURES AND REQUIRED PROTECTIVE EQUIPMENT PRIOR TO PERFORMING ANY WORK.

Use tripods, towers, and attachments to tripods and towers only for purposes for which they are designed. Do not exceed design limits. Be familiar and comply with all instructions provided in product manuals. Manuals are available at [www.campbellsci.com](http://www.campbellsci.com) or by telephoning (435) 227-9000 (USA). You are responsible for conformance with governing codes and regulations, including safety regulations, and the integrity and location of structures or land to which towers, tripods, and any attachments are attached. Installation sites should be evaluated and approved by a qualified engineer. If questions or concerns arise regarding installation, use, or maintenance of tripods, towers, attachments, or electrical connections, consult with a licensed and qualified engineer or electrician.

## General

- Prior to performing site or installation work, obtain required approvals and permits. Comply with all governing structure-height regulations, such as those of the FAA in the USA.
- Use only qualified personnel for installation, use, and maintenance of tripods and towers, and any attachments to tripods and towers. The use of licensed and qualified contractors is highly recommended.
- Read all applicable instructions carefully and understand procedures thoroughly before beginning work.
- Wear a **hardhat** and **eye protection**, and take **other appropriate safety precautions** while working on or around tripods and towers.
- **Do not climb** tripods or towers at any time, and prohibit climbing by other persons. Take reasonable precautions to secure tripod and tower sites from trespassers.
- Use only manufacturer recommended parts, materials, and tools.

## Utility and Electrical

- **You can be killed** or sustain serious bodily injury if the tripod, tower, or attachments you are installing, constructing, using, or maintaining, or a tool, stake, or anchor, come in **contact with overhead or underground utility lines**.
- Maintain a distance of at least one-and-one-half times structure height, 20 feet, or the distance required by applicable law, **whichever is greater**, between overhead utility lines and the structure (tripod, tower, attachments, or tools).
- Prior to performing site or installation work, inform all utility companies and have all underground utilities marked.
- Comply with all electrical codes. Electrical equipment and related grounding devices should be installed by a licensed and qualified electrician.

## Elevated Work and Weather

- Exercise extreme caution when performing elevated work.
- Use appropriate equipment and safety practices.
- During installation and maintenance, keep tower and tripod sites clear of un-trained or non-essential personnel. Take precautions to prevent elevated tools and objects from dropping.
- Do not perform any work in inclement weather, including wind, rain, snow, lightning, etc.

## Maintenance

- Periodically (at least yearly) check for wear and damage, including corrosion, stress cracks, frayed cables, loose cable clamps, cable tightness, etc. and take necessary corrective actions.
- Periodically (at least yearly) check electrical ground connections.

WHILE EVERY ATTEMPT IS MADE TO EMBODY THE HIGHEST DEGREE OF SAFETY IN ALL CAMPBELL SCIENTIFIC PRODUCTS, THE CUSTOMER ASSUMES ALL RISK FROM ANY INJURY RESULTING FROM IMPROPER INSTALLATION, USE, OR MAINTENANCE OF TRIPODS, TOWERS, OR ATTACHMENTS TO TRIPODS AND TOWERS SUCH AS SENSORS, CROSSARMS, ENCLOSURES, ANTENNAS, ETC.



# Table of Contents

---

PDF viewers: These page numbers refer to the printed version of this document. Use the PDF reader bookmarks tab for links to specific sections.

<b>1. Introduction</b> .....	<b>1</b>
<b>2. Cautionary Statements</b> .....	<b>1</b>
<b>3. Initial Inspection</b> .....	<b>1</b>
3.1 Ships With.....	1
<b>4. Quickstart</b> .....	<b>2</b>
<b>5. Overview</b> .....	<b>4</b>
<b>6. Specifications</b> .....	<b>6</b>
<b>7. Installation</b> .....	<b>7</b>
7.1 Mount to a Tripod or Tower.....	7
7.1.1 Tools Required.....	7
7.1.2 Mounting Procedure .....	7
7.1.2.1 CM225 Solar Sensor Mounting Stand.....	7
7.1.2.2 015ARM.....	9
7.2 Wiring .....	11
7.3 Programming.....	12
7.3.1 Input Range.....	13
7.3.2 Multiplier .....	14
7.4 Output Format Considerations .....	14
<b>8. Maintenance and Calibration</b> .....	<b>14</b>
<b>9. Troubleshooting</b> .....	<b>15</b>
<b>10. Acknowledgements</b> .....	<b>15</b>
<b>Appendices</b>	
<b>A. Importing <i>Short Cut</i> Code Into a Program Editor</b> .....	<b>A-1</b>
<b>B. Example Program</b> .....	<b>B-1</b>
B.1 Example CR1000 Program .....	B-1

**Figures**

5-1. LI190SB spectral response ..... 5  
5-2. LI190SB Quantum Sensor with –PT cable termination option ..... 5  
7-1. LI190SB schematic ..... 11  
7-2. Differential measurement connection..... 13  
7-3. Single-ended measurement connection ..... 13

**Tables**

7-1. Connections to Campbell Scientific Dataloggers..... 11  
7-2. Multiplier Required for Flux Density and Total Fluxes ..... 14  
B-1. Wiring for Example Programs ..... B-1



# LI190SB Quantum Sensor

---

## 1. Introduction

The LI190SB accurately measures Photosynthetic Photon Flux Density (PPFD) in both natural and artificial light. PPFD is the number of photons in the 400 to 700 nm waveband incident per unit time on a unit surface. Because PPFD describes photosynthetic activity, the LI190SB is ideal for growth chambers and greenhouses.

---

**NOTE**

This manual provides information only for CRBasic dataloggers. It is also compatible with most of our retired Edlog dataloggers. For Edlog datalogger support, see an older manual at [www.campbellsci.com/old-manuals](http://www.campbellsci.com/old-manuals) or contact a Campbell Scientific application engineer for assistance.

---

## 2. Cautionary Statements

- READ AND UNDERSTAND the *Precautions* section at the front of this manual.
- Care should be taken when opening the shipping package to not damage or cut the cable jacket. If damage to the cable is suspected, consult with a Campbell Scientific application engineer.
- Although the LI190SB is rugged, it should be handled as a precision scientific instrument.
- The black outer jacket of the cable is Santoprene® rubber. This compound was chosen for its resistance to temperature extremes, moisture, and UV degradation. However, this jacket will support combustion in air. It is rated as slow burning when tested according to U.L. 94 H.B. and will pass FMVSS302. Local fire codes may preclude its use inside buildings.

## 3. Initial Inspection

- Upon receipt of the LI190SB, inspect the packaging and contents for damage. File damage claims with the shipping company.
- The model number and cable length are printed on a label at the connection end of the cable. Check this information against the shipping documents to ensure the correct product and cable length are received.

### 3.1 Ships With

- (1) ResourceDVD or Instruction Manual
- (1) Calibration Sheet

**NOTE**

The calibration sheet shipped with each sensor includes a serial number and calibration constant. The calibration constant is unique for each sensor, and is used to compute the multiplier for the measurement instruction in the datalogger program.

## 4. Quickstart

*Short Cut* is an easy way to program your datalogger to measure the LI190SB and assign datalogger wiring terminals. The following procedures shows using *Short Cut* to program the LI190SB.

1. Install *Short Cut* by clicking on the install file icon. Get the install file from either [www.campbellsci.com](http://www.campbellsci.com), the ResourceDVD, or find it in installations of *LoggerNet*, *PC200W*, *PC400*, or *RTDAQ* software.



2. The *Short Cut* installation should place a *Short Cut* icon on the desktop of your computer. To open *Short Cut*, click on this icon.



3. When *Short Cut* opens, select **New Program**.

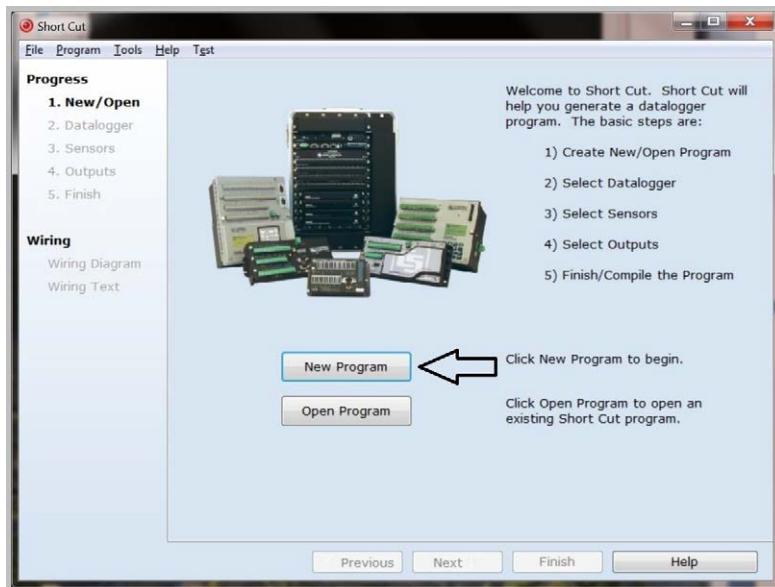

4. Select **Datalogger Model** and **Scan Interval** (default of 5 seconds is OK for most applications). Click **Next**.

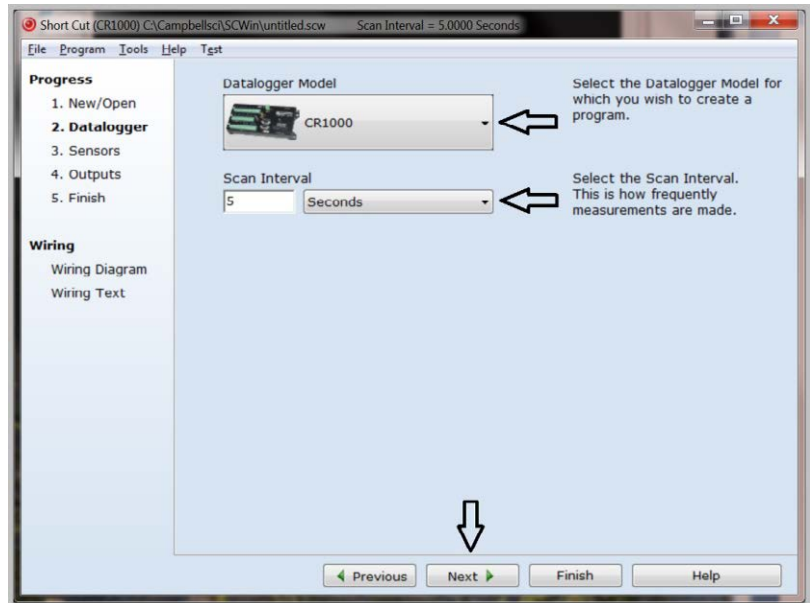

5. Under the **Available Sensors and Devices** list, select the **Sensors | Solar Radiation** folder. Select **LI190SB Quantum Sensor**. Click  to move the selection to the **Selected** device window. Enter the **LI190SB Output** that is provided on the calibration sheet shipped with the sensor. This value is unique to the individual sensor. The PAR flux density defaults to  $\mu\text{mol}/\text{m}^2$  and the PAR total flux defaults to  $\text{mmol}/\text{m}^2$ . This can be changed by clicking the **Flux Density or Total Flux** box and selecting one of the other options.

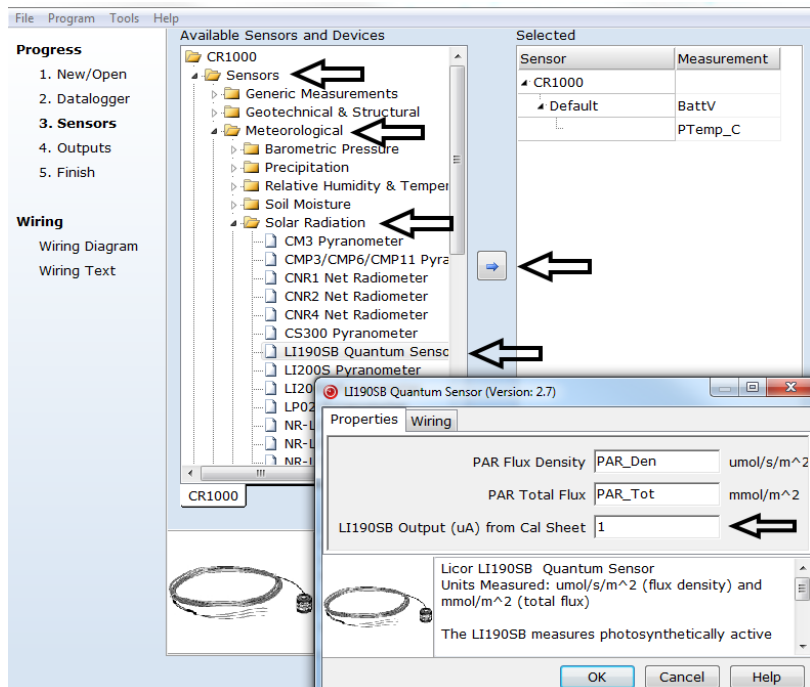

- After selecting the sensor, click at the left of the screen on **Wiring Diagram** to see how the sensor is to be wired to the datalogger. The wiring diagram can be printed out now or after more sensors are added.

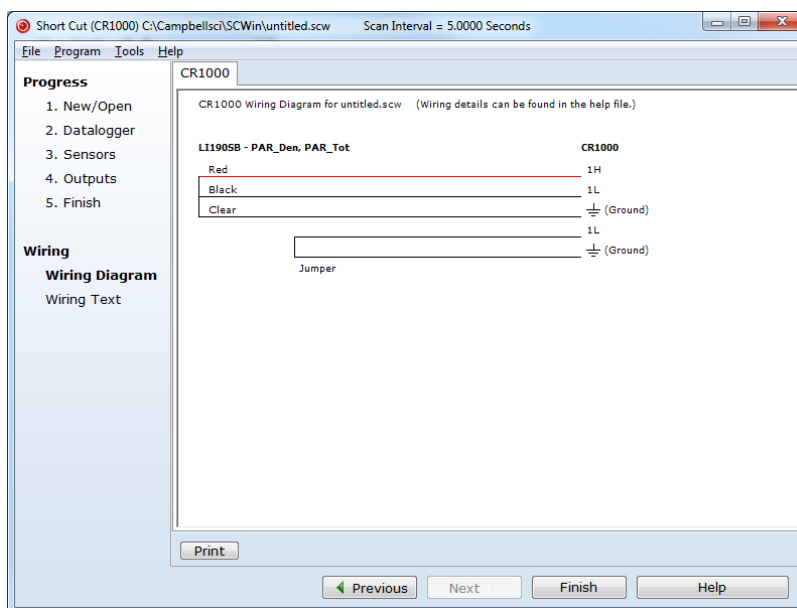

- Select any other sensors you have, then finish the remaining *Short Cut* steps to complete the program. The remaining steps are outlined in *Short Cut Help*, which is accessed by clicking on **Help | Contents | Programming Steps**.
- If *LoggerNet*, *PC400*, *RTDAQ*, or *PC200W* is running on your PC, and the PC to datalogger connection is active, you can click **Finish** in *Short Cut* and you will be prompted to send the program just created to the datalogger.
- If the sensor is connected to the datalogger, as shown in the wiring diagram in step 6, check the output of the sensor in the datalogger support software data display to make sure it is making reasonable measurements.

## 5. Overview

The LI190SB quantum sensor measures photosynthetically active radiation (PAR) in the 400 to 700 nm waveband. The unit of measurement is  $\mu\text{moles per second per square meter}$  ( $\mu\text{mol s}^{-1}\text{m}^{-2}$ ).

The quantum sensor is designed to measure PAR received on a plane surface. The indicated sensor response (FIGURE 5-1) is selected because it approximates the photosynthetic response of plants for which data are available. A silicon photodiode with an enhanced response in the visible wavelengths is used as the sensor. A visible bandpass interference filter in combination with colored glass filters is mounted in a cosine corrected head.

Measuring PAR within plant canopies, greenhouses, controlled environment chambers, confined laboratory conditions, or at remote environmental monitoring sites are all typical applications for this sensor.

During the night, the LI190SB may output a slightly negative value, caused by RF noise. Negative values may be set to zero in the datalogger program.

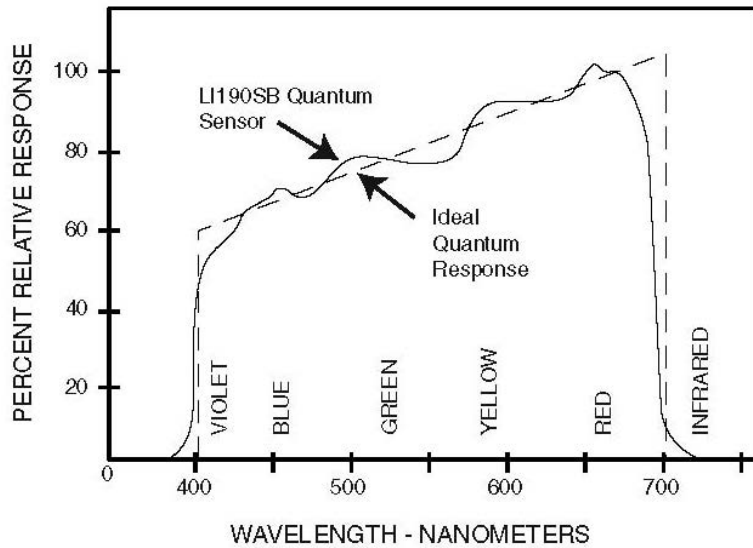

FIGURE 5-1. LI190SB spectral response

The -L portion of the model number indicates that the LI109SB has a user-specified cable length. Its cables can terminate in:

- Pigtails that connect directly to a Campbell Scientific datalogger (cable termination option -PT; see FIGURE 5-2).
- Connector that attaches to a prewired enclosure (cable termination option -PW).
- Connector that attaches to a CWS900-series interface (cable termination option -CWS). Connection to a CWS900-series interface allows this sensor to be used in a wireless sensor network.

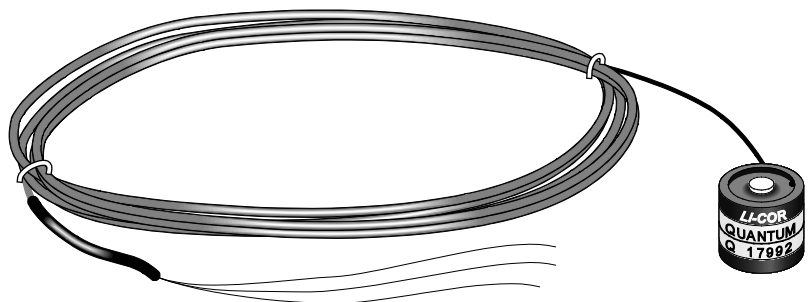

FIGURE 5-2. LI190SB Quantum Sensor with -PT cable termination option

## 6. Specifications

### Features:

- Ideal for growth chambers and greenhouses
- Measures Photosynthetic Photon Flux Density (PPFD) in both natural and artificial light
- Compatible with Campbell Scientific CRBasic dataloggers: CR6, CR800, CR850, CR1000, CR3000, CR5000, and CR9000(X)

<b>Stability:</b>	< $\pm 2\%$ change over a 1 year period
<b>Response Time:</b>	10 $\mu\text{s}$
<b>Temperature Dependence:</b>	0.15% per $^{\circ}\text{C}$ maximum
<b>Cosine Correction:</b>	Cosine corrected up to $80^{\circ}$ angle of incidence
<b>Operating Temperature:</b>	$-40$ to $65^{\circ}\text{C}$
<b>Relative Humidity:</b>	0 to 100%
<b>Detector:</b>	High stability silicon photovoltaic detector (blue enhanced)
<b>Sensor Housing:</b>	Weatherproof anodized aluminum case with acrylic diffuser and stainless steel hardware
<b>Size:</b>	2.38 cm dia x 2.54 cm H (0.94 in dia x 1.00 in H)
<b>Weight:</b>	28 g (1 oz)
<b>Calibration:</b>	$\pm 5\%$ traceable to the U.S. National Institute of Standards Technology (NIST)
<b>Sensitivity:</b>	Typically 5 $\mu\text{A}$ per 1000 $\mu\text{moles s}^{-1}\text{m}^{-2}$
<b>Linearity:</b>	Maximum deviation of 1% up to 10,000 $\mu\text{moles s}^{-1}\text{m}^{-2}$
<b>Shunt Resistor:</b>	604 ohms
<b>Light Spectrum Waveband:</b>	400 to 700 nm

## 7. Installation

If you are programming your datalogger with *Short Cut*, skip Section 7.2, *Wiring* (p.11), and Section 7.3, *Programming* (p. 12). *Short Cut* does this work for you. See Section 4, *Quickstart* (p. 24), for a *Short Cut* tutorial.

### 7.1 Mount to a Tripod or Tower

#### 7.1.1 Tools Required

Tools required for installation on a tripod or tower using a CM225 Mounting Stand and LI2003S Leveling Base:

Small and medium Phillips screwdrivers  
 1/2 inch open end wrench  
 Tape measure  
 UV-resistant wire ties  
 Side-cut pliers  
 Compass  
 Step ladder

#### 7.1.2 Mounting Procedure

##### 7.1.2.1 CM225 Solar Sensor Mounting Stand

###### CAUTION

The CM225 should never be mounted directly to a vertical pipe. Instead the CM225 should be mounted to a crossarm. This avoids reflections from the vertical pipe onto the sensor.

1. Mount the crossarm to the tripod or tower.
2. Place the CM225's U-bolt in the bottom holes and secure the CM225 to the crossarm by tightening the U-bolt nuts.

Mounting Screws

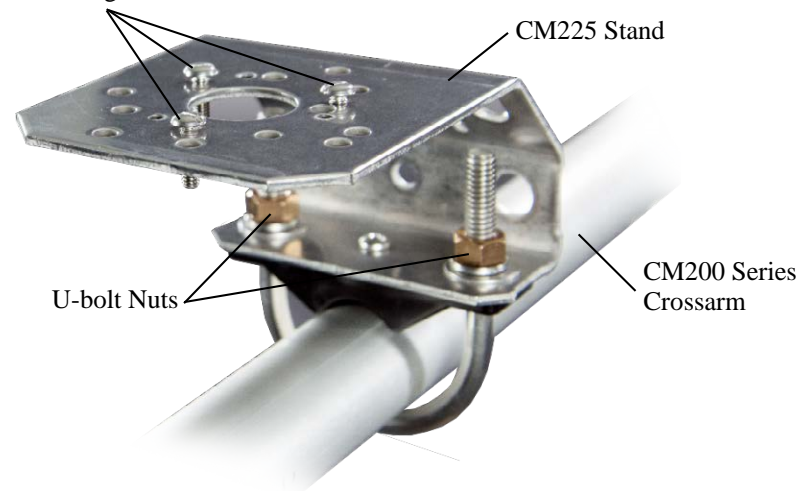

3. Place the LI190SB in the center of the LI2003S base/leveling fixture.

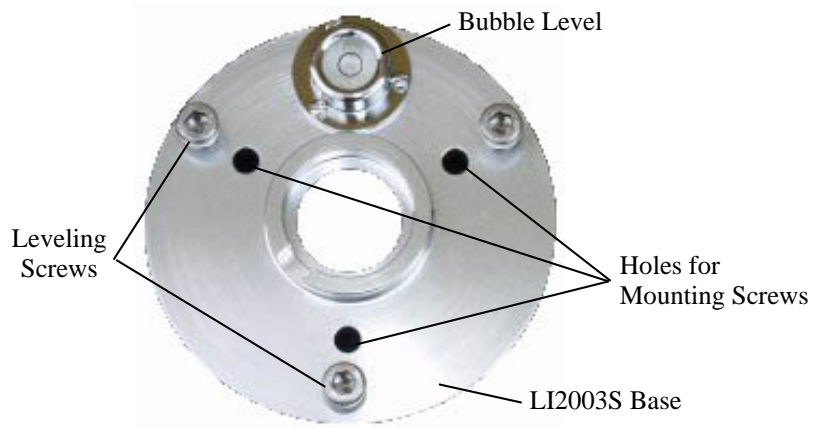

4. Loosely mount the LI2003S base/leveling fixture on the CM225. Do not fully tighten the three mounting screws.
5. Turn the leveling screws as required to bring the bubble of the bubble level within the ring.

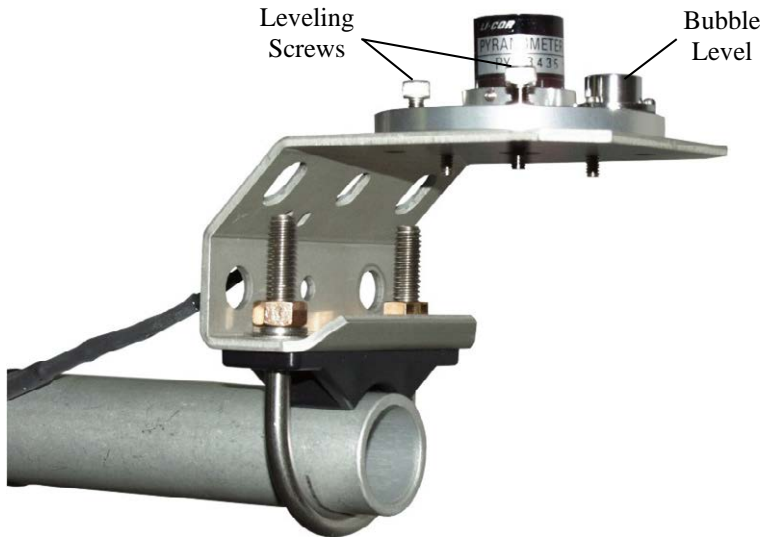

6. Tighten the mounting screws to secure the assembly in its final position. Check that the pyranometer is still correctly leveled and adjust as necessary.
7. Route the sensor cable along the underside of the crossarm to the tripod/tower, and to the instrument enclosure.
8. Secure the cable to the crossarm and mast using cable ties.
9. Remove the red cap after installing the sensor. Save this cap for shipping or storing the sensor.



**7.1.2.2 015ARM**

1. Secure the 015ARM to the mast by tightening the U-bolt nuts.

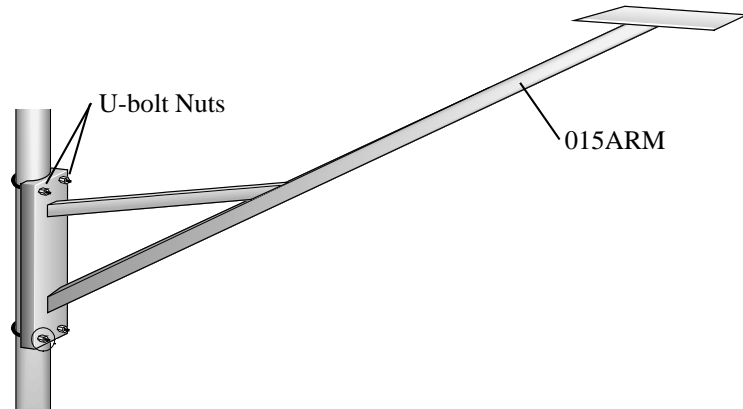

2. Place the LI190SB in the center of the LI2003S base/leveling fixture.

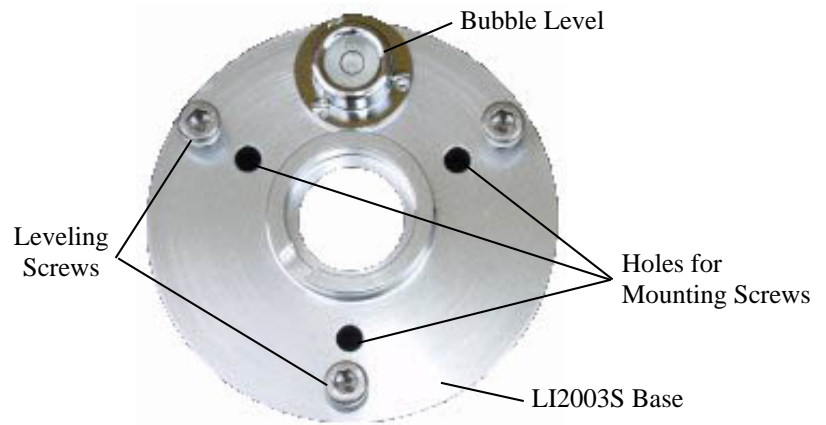

- 3. Loosely mount the LI2003S base/leveling fixture on the 015ARM. Do not fully tighten the three mounting screws.



Holes for Mounting Screws

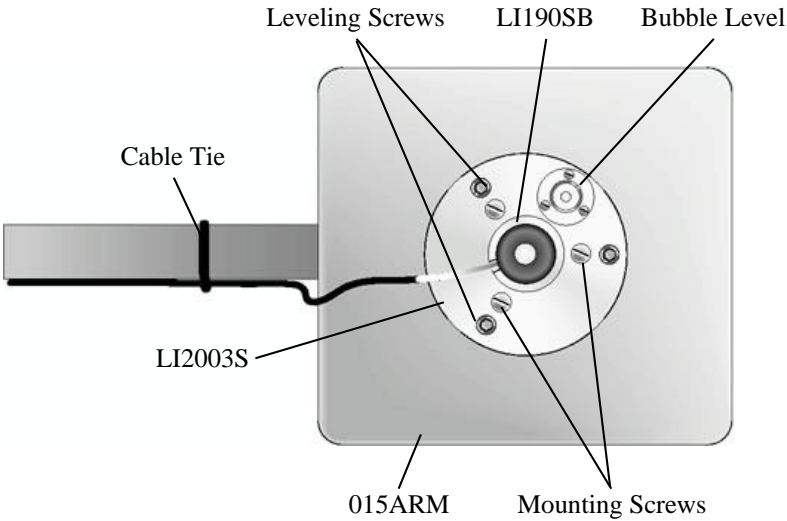

4. Turn the leveling screws as required to bring the bubble of the bubble level within the ring.
5. Tighten the mounting screws to secure the assembly in its final position. Check that the pyranometer is still correctly leveled and adjust as necessary.
6. Route the sensor cable along the underside of the 015ARM's arm to the tripod/tower, and to the instrument enclosure.
7. Secure the cable to the mounting arm and mast using cable ties.
8. Remove the red cap after installing the sensor. Save this cap for shipping or storing the sensor.

## 7.2 Wiring

A schematic diagram of the LI190SB is shown in FIGURE 7-1.

Connections to Campbell Scientific dataloggers are given in TABLE 7-1. When *Short Cut* software is used to create the datalogger program, the sensor should be wired to the channels shown in the wiring diagram created by *Short Cut*.

**TABLE 7-1. Connections to Campbell Scientific Dataloggers**

Color	Description	CR6, CR9000(X), CR5000, CR3000, CR1000, CR800, CR850
Red	Signal	Differential High
Black	Signal Reference	Differential Low
Clear	Shield	⊥

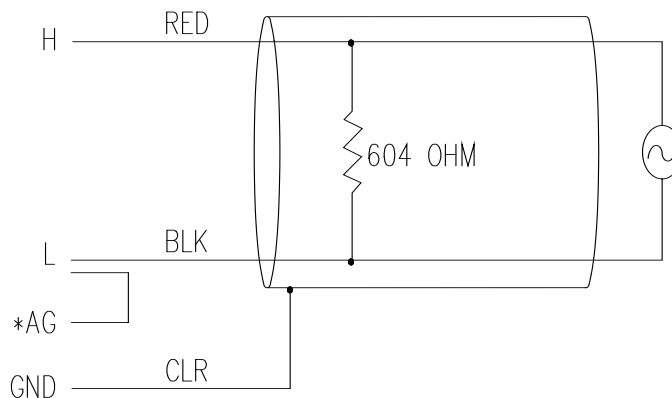

\*Jumper to AG or ⊥ with user supplied wire.

FIGURE 7-1. LI190SB schematic

## 7.3 Programming

*Short Cut* is the best source for up-to-date datalogger programming code. Programming code is needed

- when creating a program for a new datalogger installation
- when adding sensors to an existing datalogger program

If your data acquisition requirements are simple, you can probably create and maintain a datalogger program exclusively with *Short Cut*. If your data acquisition needs are more complex, the files that *Short Cut* creates are a great source for programming code to start a new program or add to an existing custom program.

### NOTE

---

*Short Cut* cannot edit programs after they are imported and edited in *CRBasic Editor*.

---

A *Short Cut* tutorial is available in Section 4, *Quickstart* (p. 2). If you wish to import *Short Cut* code into *CRBasic Editor* to create or add to a customized program, follow the procedure in Appendix A, *Importing Short Cut Code Into a Program Editor* (p. A-1). Programming basics for CRBasic dataloggers are provided in the following sections. A complete program example for a CRBasic datalogger can be found in Appendix B, *Example Program* (p. B-1). Programming basics and programming examples for Edlog dataloggers are provided at [www.campbellsci.com/old-manuals](http://www.campbellsci.com/old-manuals).

Output from the LI190SB is a voltage ranging from 0 to a maximum of 10 mV depending on sensor calibration and radiation level, which is measured by the datalogger using a differential analog input channel. To measure the output, CRBasic dataloggers are programmed with the **VoltDiff()** Instruction.

Nearby ac power lines, electric pumps, or motors can be a source of electrical noise. If the sensor or datalogger is located in an electrically noisy environment, the measurement should be made with the 60 or 50 Hz rejection integration option as shown in the example programs.

Solar radiation can be reported as an average flux density ( $\mu\text{mole s}^{-1}\text{m}^{-2}$ ) or daily total flux density ( $\text{mmoles m}^{-2}$ ). The appropriate multipliers are listed in TABLE 7-2.

If a differential channel is not available, a single-ended measurement is a possibility; the **VoltSE()** CRBasic instruction is used to make single-ended measurements. As a test, wire the LI190SB as shown in FIGURE 7-2 and make single-ended and differential measurements. Compare the results to determine the acceptability of a single ended measurement.

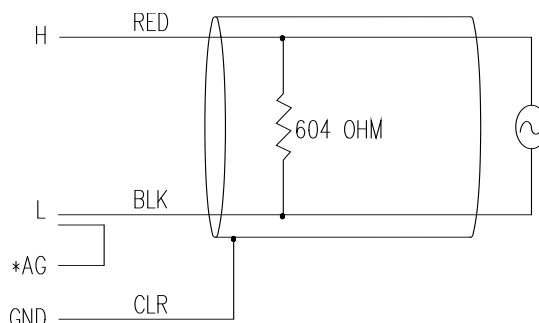

FIGURE 7-2. Differential measurement connection

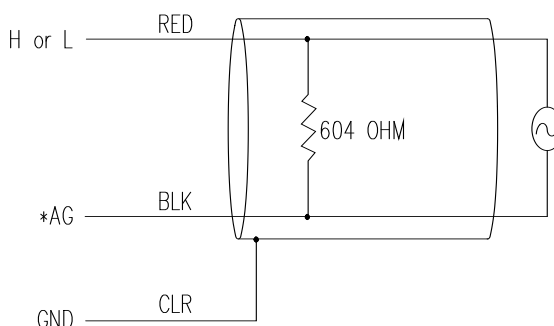

FIGURE 7-3. Single-ended measurement connection

### 7.3.1 Input Range

An example showing how to determine the optimum input range for a given sensor calibration and maximum photosynthetically active radiation (PAR) is given below. This is an example only. Your values will be different.

**Sensor Calibration:** Assume the sensor calibration is  $8 \mu\text{A}/1000 \mu\text{moles s}^{-1}\text{m}^{-2}$  ( $1000 \mu\text{moles} = 1 \text{mmole}$ ). The LI190SB outputs amperage which is converted to voltage by a 604 ohm shunt resistor in the cable. To convert the calibration from  $\mu\text{A}$  to millivolts, multiply the calibration by 0.604. The example calibration changes to  $4.83 \text{mV}/\text{mmole s}^{-1}\text{m}^{-2}$ .

**Maximum PAR:** A reasonable estimate of maximum PAR is  $2 \text{mmoles s}^{-1}\text{m}^{-2}$ .

**Input Range Selection:** An estimate of the maximum input voltage is obtained by multiplying the calibration by the maximum expected PAR. That product is  $9.66 \text{mV}$  for this example. Select the smallest input range which is greater than the maximum expected input voltage

Measurement integration time is specified in the input range parameter code. A more noise-free reading is obtained with the slow or 60 Hz rejection integration. A fast integration takes less power and allows for faster throughput.

### 7.3.2 Multiplier

The multiplier converts the millivolt reading to engineering units. Commonly used units and how to calculate the multiplier are shown in TABLE 7-2.

TABLE 7-2. Multiplier Required for Flux Density and Total Fluxes	
UNITS	MULTIPLIER
$\mu\text{mole s}^{-1} \text{m}^{-2}$	1000/C (flux density)
$\text{mmoles m}^{-2}$	(1/C)*t (total fluxes)
C = (LI-COR calibration)*0.604 t = datalogger program execution interval in seconds	
<u>Unit Conversions</u> microEinstein/ $\mu\text{mole}$ $(6.02 \times 10^{17} \text{ photons s}^{-1} \text{m}^{-2})/(\mu\text{moles s}^{-1} \text{m}^{-2})$	

### 7.4 Output Format Considerations

If solar radiation is totalized in units of  $\text{mmoles m}^{-2}$ , there is a possibility of overranging the output limits. For CRBasic dataloggers, you can avoid this by using the IEEE4 or long data format.

The disadvantage of the high resolution formats is that it takes more memory per data point.

## 8. Maintenance and Calibration

DO NOT use alcohol, organic solvents, abrasives, or strong detergents to clean the diffuser element.

The acrylic materials used in LI-COR light sensors can be crazed by exposure to alcohol or organic solvents, which will adversely affect the cosine response of the sensor.

Clean the sensor only with water and/or a mild detergent such as dishwashing soap. Vinegar can also be used to remove hard water deposits from the diffuser element, if necessary.

Keep the sensors clean and treat them as a scientific instrument in order to maintain the accuracy of the calibration. The vertical edge of the diffuser must be kept clean in order to maintain appropriate cosine correction.

The LI190SB should be recalibrated every two years. Obtain an RMA number before returning the sensor to Campbell Scientific, Inc. for recalibration.

## 9. Troubleshooting

Symptom: -9999 or radiation values around 0

1. Check that the sensor is wired to the differential channel specified by the measurement instruction.
2. Verify that the range code is correct for the datalogger type.
3. Disconnect the sensor leads from the datalogger and use a DVM to check the voltage between the red (+) and the black (-) wires. The voltage should be 0 – 10 mV for 0 to 1000  $\text{Wm}^{-2}$  radiation. No voltage indicates a problem with the photodiode, cable, or the variable shunt resistor.

Symptom: Incorrect solar radiation

1. Make sure the top surface of the sensor head is clean, and that the sensor is properly leveled.
2. Verify that the Range code, multiplier and offset parameters are correct for the desired engineering units and datalogger type.

## 10. Acknowledgements

Campbell Scientific, Inc. gratefully acknowledges the contribution of LI-COR to concepts, text, and images used in this manual.





# Appendix A. Importing Short Cut Code Into a Program Editor

---

This tutorial shows:

- How to import a *Short Cut* program into a program editor for additional refinement
- How to import a wiring diagram from *Short Cut* into the comments of a custom program

*Short Cut* creates files that can be imported into either *CRBasic Editor* or *Edlog* program editor. These files normally reside in the C:\campbellsci\SCWin folder and have the following extensions:

- .DEF (wiring and memory usage information)
- .CR6 (CR6 datalogger code)
- .CR1 (CR1000 datalogger code)
- .CR8 (CR800 or CR850 datalogger code)
- .CR3 (CR3000 datalogger code)
- .CR5 (CR5000 datalogger code)

Use the following procedure to import *Short Cut* code into *CRBasic Editor* (CR6, CR1000, CR800, CR850, CR3000, CR5000 dataloggers).

1. Create the *Short Cut* program following the procedure in Section 4, *Quickstart* (p. 2). Finish the program and exit *Short Cut*. Make note of the file name used when saving the *Short Cut* program.
2. Open *CRBasic Editor*.
3. Click **File** | **Open**. Assuming the default paths were used when *Short Cut* was installed, navigate to C:\CampbellSci\SCWin folder. The file of interest has a “.CR6”, “.CR1”, “.CR8”, “.CR3”, or “.CR5” extension, for CR6, CR1000, CR800/CR850, CR3000, or CR5000 dataloggers, respectively. Select the file and click **Open**.
4. Immediately save the file in a folder different from \Campbellsci\SCWin, or save the file with a different file name.

---

## NOTE

Once the file is edited with *CRBasic Editor*, *Short Cut* can no longer be used to edit the datalogger program. Change the name of the program file or move it, or *Short Cut* may overwrite it next time it is used.

---

5. The program can now be edited, saved, and sent to the datalogger.
6. Import wiring information to the program by opening the associated .DEF file. Copy and paste the section beginning with heading “-Wiring for CRXXX-” into the *CRBasic* program, usually at the head of the file. After pasting, edit the information such that a ' character (single quotation

mark) begins each line. This character instructs the datalogger compiler to ignore the line when compiling the datalogger code.

# Appendix B. Example Program

## B.1 Example CR1000 Program

The following program measures the LI190SB every 10 seconds, and converts the mV output to  $\mu\text{moles s}^{-1}\text{m}^{-2}$  and  $\text{mmoles m}^{-2}$ . It outputs an hourly average flux ( $\mu\text{moles s}^{-1}\text{m}^{-2}$ ) and a daily total flux density ( $\text{mmoles m}^{-2}$ ).

Color	Description	CR1000
Red	Signal	1H
*Black	Signal Reference	1L
Clear	Shield	$\perp$

\*Jumper to AG or  $\perp$  with user supplied wire.

Wiring for the example is given in TABLE B-1. The multipliers is based upon a sensor calibration constant of  $6.45 \mu\text{A}/1000 \mu\text{moles s}^{-1}\text{m}^{-2}$ .

```
'CR1000

'Declare Variables and Units
Public PAR_Den
Public PAR_Tot

Units PAR_Den= $\mu\text{mol/s/m}^2$ 
Units PAR_Tot= $\text{mmol/m}^2$ 

'Define Data Tables
DataTable(Table1,True,-1)
    DataInterval(0,60,Min,10)
    Average(1,PAR_Den,FP2,False)
EndTable

DataTable(Table2,True,-1)
    DataInterval(0,1440,Min,10)
    Totalize(1,PAR_Tot,IEEE4,False)
EndTable

'Main Program
BeginProg
    Scan(10,Sec,1,0)
    'LI190SB Quantum Sensor measurements PAR_Tot and PAR_Den:
    VoltDiff(PAR_Den,1,mV25,1,True,0,_60Hz,1,0) 'Use 20 mV range for CR3000, CR5000
    'Set negative values to zero
    If PAR_Den<0 Then PAR_Den=0
    PAR_Tot=PAR_Den*2.56686 'Multipliers will differ for each sensor and scan rate
    PAR_Den=PAR_Den*256.686
    'Call Data Tables and Store Data
    CallTable(Table1)
    CallTable(Table2)
    NextScan
EndProg
```





## Campbell Scientific Companies

---

**Campbell Scientific, Inc. (CSI)**

815 West 1800 North  
Logan, Utah 84321  
UNITED STATES

[www.campbellsci.com](http://www.campbellsci.com) • [info@campbellsci.com](mailto:info@campbellsci.com)

**Campbell Scientific Africa Pty. Ltd. (CSAf)**

PO Box 2450  
Somerset West 7129  
SOUTH AFRICA

[www.csafrica.co.za](http://www.csafrica.co.za) • [cleroux@csafrica.co.za](mailto:cleroux@csafrica.co.za)

**Campbell Scientific Australia Pty. Ltd. (CSA)**

PO Box 8108  
Garbutt Post Shop QLD 4814  
AUSTRALIA

[www.campbellsci.com.au](http://www.campbellsci.com.au) • [info@campbellsci.com.au](mailto:info@campbellsci.com.au)

**Campbell Scientific (Beijing) Co., Ltd.**

8B16, Floor 8 Tower B, Hanwei Plaza  
7 Guanghua Road  
Chaoyang, Beijing 100004  
P.R. CHINA

[www.campbellsci.com](http://www.campbellsci.com) • [info@campbellsci.com.cn](mailto:info@campbellsci.com.cn)

**Campbell Scientific do Brasil Ltda. (CSB)**

Rua Apinagés, nbr. 2018 — Perdizes  
CEP: 01258-00 — São Paulo — SP  
BRASIL

[www.campbellsci.com.br](http://www.campbellsci.com.br) • [vendas@campbellsci.com.br](mailto:vendas@campbellsci.com.br)

**Campbell Scientific Canada Corp. (CSC)**

14532 – 131 Avenue NW  
Edmonton AB T5L 4X4  
CANADA

[www.campbellsci.ca](http://www.campbellsci.ca) • [dataloggers@campbellsci.ca](mailto:dataloggers@campbellsci.ca)

**Campbell Scientific Centro Caribe S.A. (CSCC)**

300 N Cementerio, Edificio Breller  
Santo Domingo, Heredia 40305  
COSTA RICA

[www.campbellsci.cc](http://www.campbellsci.cc) • [info@campbellsci.cc](mailto:info@campbellsci.cc)

**Campbell Scientific Ltd. (CSL)**

Campbell Park  
80 Hathern Road  
Shepshed, Loughborough LE12 9GX  
UNITED KINGDOM

[www.campbellsci.co.uk](http://www.campbellsci.co.uk) • [sales@campbellsci.co.uk](mailto:sales@campbellsci.co.uk)

**Campbell Scientific Ltd. (CSL France)**

3 Avenue de la Division Leclerc  
92160 ANTONY  
FRANCE

[www.campbellsci.fr](http://www.campbellsci.fr) • [info@campbellsci.fr](mailto:info@campbellsci.fr)

**Campbell Scientific Ltd. (CSL Germany)**

Fahrenheitstraße 13  
28359 Bremen  
GERMANY

[www.campbellsci.de](http://www.campbellsci.de) • [info@campbellsci.de](mailto:info@campbellsci.de)

**Campbell Scientific Spain, S. L. (CSL Spain)**

Avda. Pompeu Fabra 7-9, local 1  
08024 Barcelona  
SPAIN

[www.campbellsci.es](http://www.campbellsci.es) • [info@campbellsci.es](mailto:info@campbellsci.es)

Please visit [www.campbellsci.com](http://www.campbellsci.com) to obtain contact information for your local US or international representative.