

FEATURES

Low noise density: 0.015°/sec/√Hz
±300°/sec dynamic range
Z-axis, yaw rate response
Calibrated offset and sensitivity
320 Hz bandwidth, adjustable
35 ms turn-on time
Digital self-test
High vibration rejection
High shock survivability
Embedded temperature sensor output
Precision voltage reference output
5 V single-supply operation
-40°C to +85°C temperature range

APPLICATIONS

Guidance and control
Instrumentation
Inertial measurement units (IMU)
Stabilization

GENERAL DESCRIPTION

The ADIS16120 is a low noise, angular rate sensor (gyroscope) that includes all of the necessary embedded signal conditioning to provide a low noise, analog output over the complete dynamic range of ±300°/sec. Factory calibration provides excellent offset and gain accuracy. The unique design implementation provides superior stability over variations in temperature, voltage, linear acceleration, vibration, and next level assembly. The surface-micromachining manufacturing technology is the same high volume BiMOS process used by Analog Devices, Inc., for its high reliability automotive sensor products.

The output signal, RATEOUT, is a voltage proportional to the angular rate about the axis that is normal to the top surface of the package. A precision reference and a temperature output are provided for system-level calibrations and a digital self-test feature is provided to enable system-level diagnostics. The self-test function electromechanically excites the sensor to verify proper operation.

The 35.6 mm × 42.4 mm (plus mounting extensions) package provides the convenience of a standard geometry 24-pin interface and four mounting holes for simple installation.

FUNCTIONAL BLOCK DIAGRAM

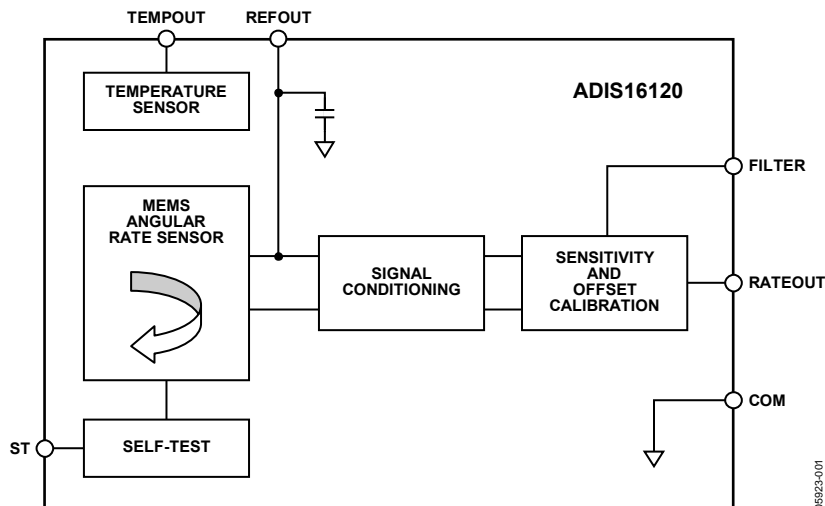

Figure 1.

Rev. B

Information furnished by Analog Devices is believed to be accurate and reliable. However, no responsibility is assumed by Analog Devices for its use, nor for any infringements of patents or other rights of third parties that may result from its use. Specifications subject to change without notice. No license is granted by implication or otherwise under any patent or patent rights of Analog Devices. Trademarks and registered trademarks are the property of their respective owners.

TABLE OF CONTENTS

Features	1	Typical Performance Characteristics	6
Applications.....	1	Theory of Operation	8
General Description	1	Setting the Bandwidth	8
Functional Block Diagram	1	Self-Test Function	8
Revision History	2	Applications Information	9
Specifications.....	3	Achieving Optimal Noise Performance	9
Absolute Maximum Ratings.....	4	Using the ADIS16120 with a Supply Ratiometric ADC	9
Thermal Resistance	4	Second-Level Assembly	9
Rate Sensitive Axis	4	Outline Dimensions	11
ESD Caution.....	4	Ordering Guide	11
Pin Configuration and Function Descriptions.....	5		

REVISION HISTORY

11/07—Rev. A to Rev. B

Changes to Angle Random Walk Section of Table 1	3
Changes to Ordering Guide	11

11/06—Rev. 0 to Rev. A

Changes to Specifications Section.....	3
Added Figure 13	8

7/06—Revision 0: Initial Version

SPECIFICATIONS

$T_A = 25^\circ\text{C}$, $V_{CC} = 5\text{ V}$, angular rate = $0^\circ/\text{sec}$, $C_{OUT} = 0\ \mu\text{F}$, $\pm 1\text{ g}$, unless otherwise noted.

Table 1.

Parameter	Conditions	Min ¹	Typ	Max ¹	Unit
SENSITIVITY					
Dynamic Range ²	Clockwise rotation is positive output Full-scale range over specified operating conditions	± 300			Degrees/sec
Initial	25°C	4.95	5	5.05	mV/degrees/sec
Over Temperature ³		4.75	5	5.25	mV/degrees/sec
Nonlinearity	Best fit straight line		0.04		% of FS
NULL					
Initial Null		2.49	2.50	2.51	V
Over Temperature	$V_S = 4.75\text{ V to }5.25\text{ V}$	2.4		2.6	V
In Run Bias Stability	1 σ @ 25°C		0.005		Degrees/sec
Angle Random Walk	1 σ @ 25°C		0.9		Degrees/sec/ $\sqrt{\text{hr}}$
Turn-On Time	Power on to $\pm 0.5^\circ/\text{sec}$ of final value, 80 Hz bandwidth		35		ms
Linear Acceleration Effect	Any axis		0.05		Degrees/sec/g
Voltage Sensitivity	$V_{CC} = 4.75\text{ V to }5.25\text{ V}$		0.4		Degrees/sec/V
NOISE PERFORMANCE					
Rate Noise Density ⁴	25°C		0.015	0.020	Degrees/sec/ $\sqrt{\text{Hz}}$
FREQUENCY RESPONSE					
3 dB Bandwidth ⁵	No external capacitance		320		Hz
Sensor Resonant Frequency			14		kHz
SELF-TEST INPUTS					
ST RATEOUT Response ⁶	ST pin from Logic 0 to Logic 1	175	270	365	mV
Logic 1 Input Voltage	Standard high logic level definition	3.3			V
Logic 0 Input Voltage	Standard low logic level definition			1.7	V
Input Impedance	To common		3.13		k Ω
TEMPERATURE SENSOR					
V_{OUT} at 298 K			2.50		V
Max Current Load on Pin	Source to common			50	μA
Scale Factor	Proportional to absolute temperature		8.4		mV/K
OUTPUT DRIVE CAPABILITY					
Output Voltage Swing	$I_{OUT} = \pm 1\text{ mA}$	0.25		$V_S - 0.25$	V
Capacitive Load Drive ⁷		1000			pF
2.5 V REFERENCE					
Voltage Value		2.45	2.5	2.55	V
Load Drive to Ground	Source		150		μA
Load Regulation	$0\ \mu\text{A} < I_{OUT} < 200\ \mu\text{A}$		5		mV/mA
Power Supply Rejection	$4.75\text{ V}_S \text{ to }5.25\text{ V}_S$		1		mV/V
Temperature Drift	Delta from 25°C		5		mV
POWER SUPPLY					
Operating Voltage Range		4.75	5.00	5.25	V
Quiescent Supply Current	$I_{OUT} = 0\text{ mA}$, 5 V, 25°C		95	110	mA
TEMPERATURE RANGE					
Specified Performance Grade A	Temperature tested to minimum and maximum specifications	-40		+85	°C

¹ All minimum and maximum specifications are guaranteed. Typical specifications are not tested or guaranteed.

² Dynamic range is the maximum full-scale measurement range possible, including output swing range, initial offset, sensitivity, offset drift, and sensitivity drift at 4.75 V to 5.25 V supplies.

³ Specification refers to the maximum extent of this parameter as a worst-case value of T_{MIN} or T_{MAX} , along with long-term effects.

⁴ Resulting bias stability is $<0.01^\circ/\text{sec}$.

⁵ Frequency at which response is 3 dB from dc response. See the Setting the Bandwidth section for adjusting this value.

⁶ Self-test response varies with temperature.

⁷ The value offered herein assures stability in the output buffer amplifier stage and no degradation of other specified performance parameters.

ADIS16120

ABSOLUTE MAXIMUM RATINGS

Table 2.

Parameter	Rating
Acceleration (Any Axis, Unpowered, 0.5 ms)	2000 g
Acceleration (Any Axis, Powered, 0.5 ms)	2000 g
+V _S	-0.3 V to +6.0 V
Output Short-Circuit Duration (Any Pin to Common)	Indefinite
Operating Temperature Range	-55°C to +125°C
Storage Temperature Range	-65°C to +150°C

Stresses above those listed under Absolute Maximum Ratings may cause permanent damage to the device. This is a stress rating only; functional operation of the device at these or any other conditions above those indicated in the operational section of this specification is not implied. Exposure to absolute maximum rating conditions for extended periods may affect device reliability.

Drops onto hard surfaces can cause shocks of greater than 2000 g and exceed the absolute maximum rating of the device. Care should be exercised in handling to avoid damage.

THERMAL RESISTANCE

The ADIS16120 provides a temperature output that is representative of the junction temperature. This can be used for system-level monitoring and power management/thermal characterization.

Table 3. Thermal Characteristics

Package Type	θ_{JA}	θ_{JC}	Weight
24-Lead PCB Module	15.7°C/W	1.48°C/W	28.5 grams typical

RATE SENSITIVE AXIS

The ADIS16120 is a z-axis rate sensing device that is also called a yaw rate sensing device. It produces a positive-going change in the output voltage as a result of clockwise rotation about the axis, normal to the package top; that is, clockwise when looking down at the package lid.

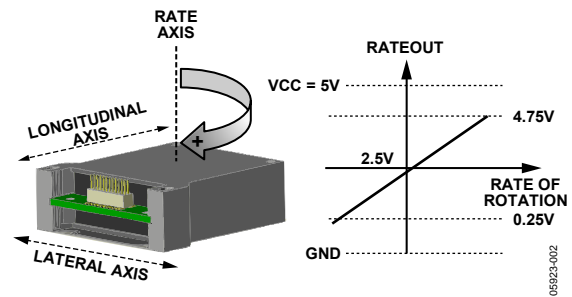

Figure 2. Rotational Measurement Orientation

ESD CAUTION



ESD (electrostatic discharge) sensitive device. Charged devices and circuit boards can discharge without detection. Although this product features patented or proprietary protection circuitry, damage may occur on devices subjected to high energy ESD. Therefore, proper ESD precautions should be taken to avoid performance degradation or loss of functionality.

PIN CONFIGURATION AND FUNCTION DESCRIPTIONS

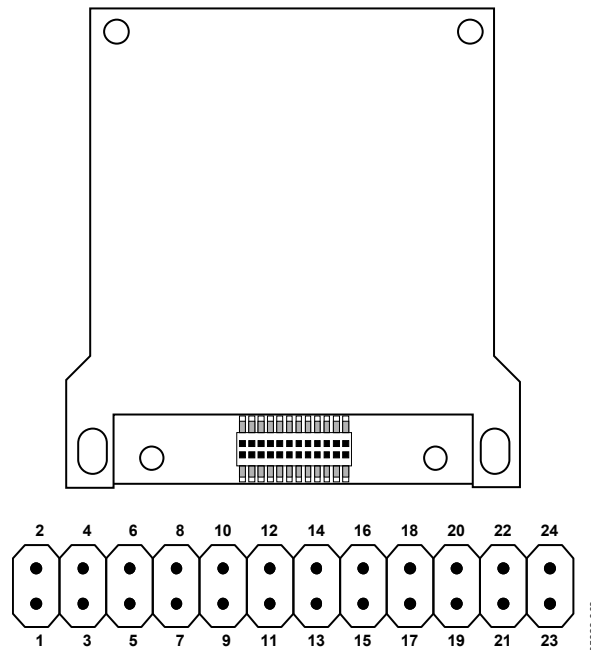

Figure 3. Pin Configuration (Connector-Up View)

Table 4. Pin Function Descriptions

Pin No.	Mnemonic	Description
1	ST	Self-Test.
2	ST	Self-Test.
3	ST	Self-Test.
4	ST	Self-Test.
5	ST	Self-Test.
6	ST	Self-Test.
7	ST	Self-Test.
8	COM	Power Supply Ground.
9	ST	Self-Test.
10	TEMPOUT	Temperature Sensor Output.
11	DNC	Do Not Connect.
12	REFOUT	Reference Voltage.
13	VCC	Power Supply.
14	COM	Power Supply Ground.
15	VCC	Power Supply.
16	COM	Power Supply Ground.
17	COM	Power Supply Ground.
18	RATEOUT	Angular Rate Output Signal.
19	COM	Power Supply Ground.
20	FILTER	Filter Input. This is used in conjunction with RATEOUT; see the Setting the Bandwidth section for use.
21	DNC	Do Not Connect.
22	DNC	Do Not Connect.
23	COM	Power Supply Ground.
24	DNC	Do Not Connect.

TYPICAL PERFORMANCE CHARACTERISTICS

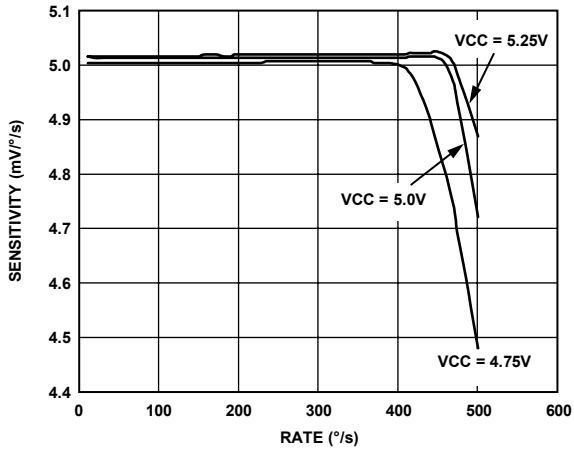

Figure 4. Gain Sensitivity vs. Angular Rate and Power Supply

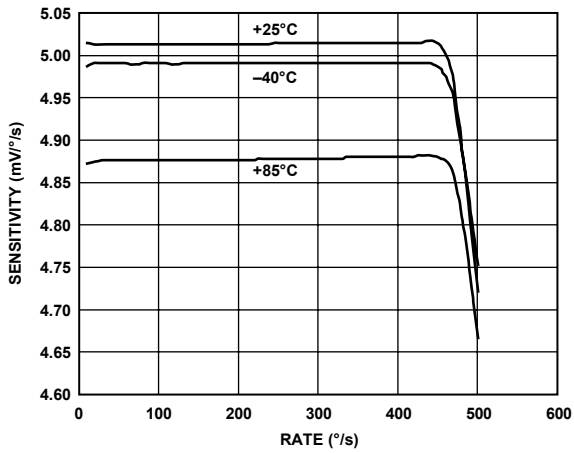

Figure 5. Gain Sensitivity vs. Angular Rate and Temperature, VCC = 5 V

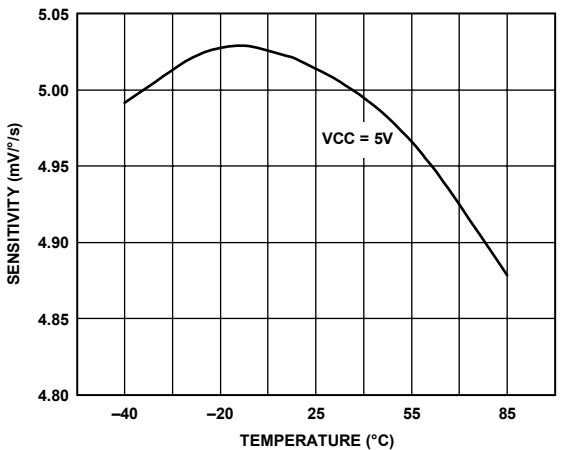

Figure 6. Gain Sensitivity vs. Temperature @ ±300°/sec

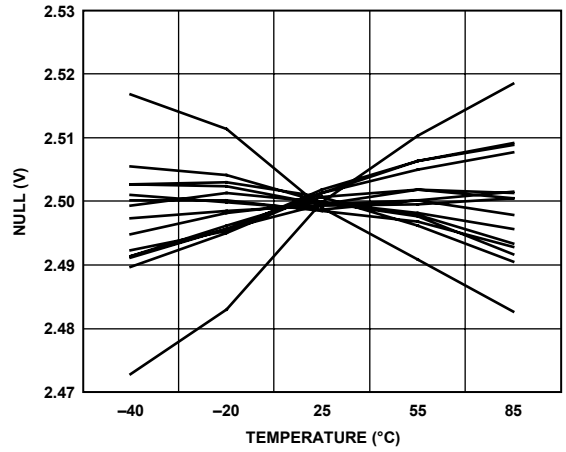

Figure 7. Null vs. Temperature, VCC = 5 V

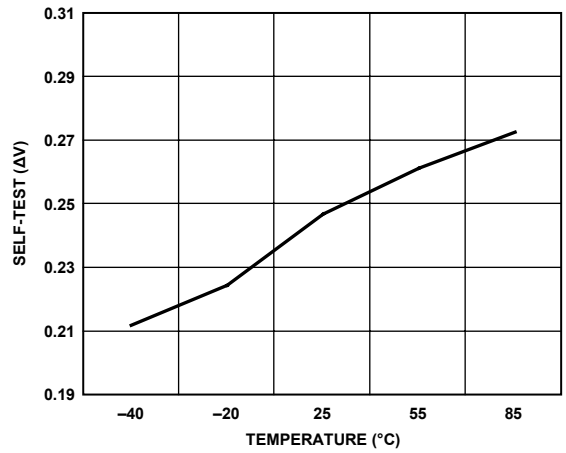

Figure 8. Self-Test vs. Temperature, VCC = 5 V

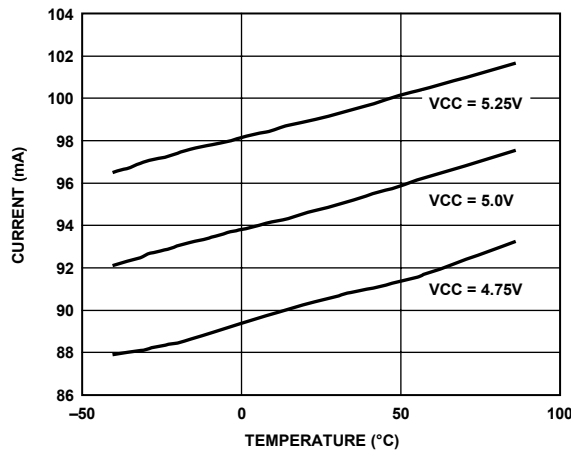

Figure 9. Power Supply Current vs. Temperature and Power Supply

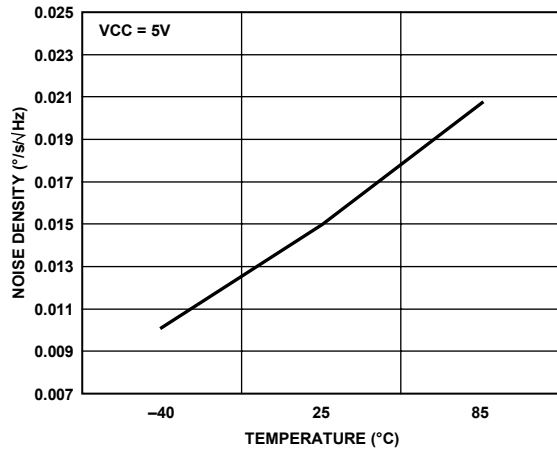

Figure 10. Noise Density vs. Temperature, VCC = 5 V

05923-010

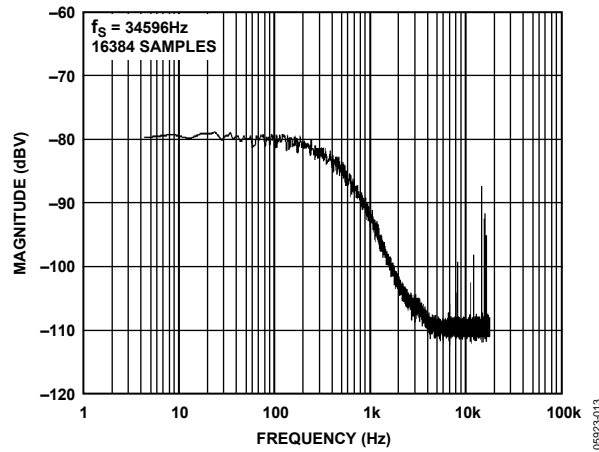

Figure 12. Noise Density vs. Frequency

05923-013

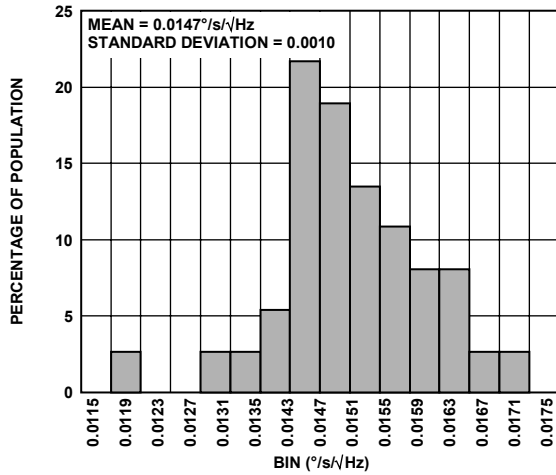

Figure 11. Noise Histogram

05923-011

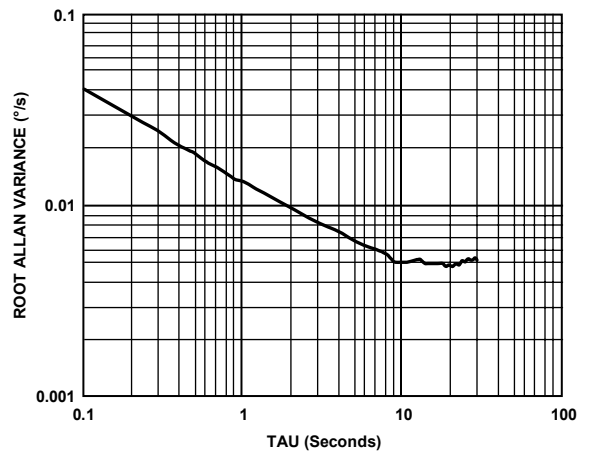

Figure 13. Root Allan Variance vs. Integration Time

05923-014

THEORY OF OPERATION

The base sensor in the ADIS16120 operates on the principle of a resonator gyroscope. Two polysilicon sensing structures each contain a dither frame that is electrostatically driven to resonance. This produces the necessary velocity element that creates a Coriolis force during angular motion. At the two outer extremes of each frame, orthogonal to the dither motion, are movable fingers that are placed between fixed fingers to form a capacitive pickoff structure that senses Coriolis acceleration. The resulting signal is fed to a series of gain and demodulation stages that produce the representative rate signal output. One advantage of the core dual-sensor design approach is that it provides improved rejection of external g -forces and vibration.

The ADIS16120 signal conditioning circuit provides an optimized filtering network that controls the resonators influence on noise while supporting a nominal bandwidth of 320 Hz. Another feature that helps reduce sensitivity to power supply noise is the integration of approximately 1.8 μF of decoupling capacitance inside the ADIS16120.

The offset and sensitivity performance is factory calibrated, and the internal reference voltage used in this calibration process is offered for external use. A temperature sensor is also provided for system level use, where appropriate.

SETTING THE BANDWIDTH

An important trade-off in angular rate measurement applications is the one between total system noise and bandwidth. The ADIS16120 offers the flexibility to optimize this trade-off at the system level. The signal processing circuit of the ADIS16120 provides a three-pole, low-pass filter, as shown in Figure 14.

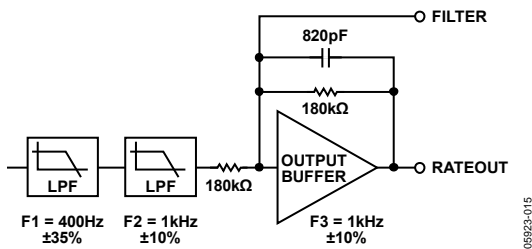

Figure 14. Simplified Filtering Network

The bandwidth of the third stage can be reduced by installing a single capacitor across the RATEOUT and FILTER pins. Figure 15 shows a relationship for selecting the appropriate capacitor value, and Table 5 provides bandwidth estimates for standard capacitor values.

The initial bandwidth of the ADIS16120 is dominated by the first stage and is dependent on the process variation of the base sensor. By reducing the bandwidth of the third filter stage, the influence of the first stage is reduced, and tighter bandwidth tolerances can be achieved.

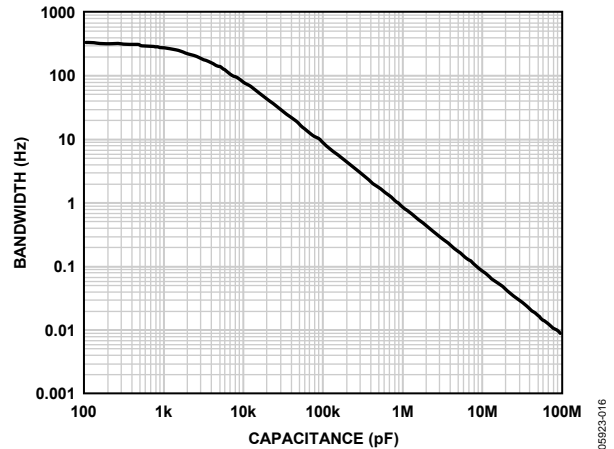

Figure 15. Bandwidth vs. Capacitance

Table 5. Nominal Bandwidth for Standard Capacitor Values

C (pF)	BW (Hz)	C (pF)	BW (Hz)
1000	267.3	10,000	78.4
1200	256.2	12,000	67.1
1500	244.1	15,000	55.2
1800	225.5	18,000	46.4
2200	211.9	22,000	38.8
2700	192.3	27,000	31.8
3300	173.2	33,000	26.2
3900	156.4	39,000	22.2
4300	148.9	43,000	20.2
4700	140.4	47,000	18.5
5100	132.9	51,000	17.1
5600	124.5	56,000	15.6
6200	115.6	62,000	14.1
7500	99.0	75,000	11.7
8200	92.7	82,000	10.7
9100	85.5	91,000	9.6

SELF-TEST FUNCTION

The ADIS16120 provides a self-test function that exercises the mechanical structure of the sensor. To use this function, Pin 1 to Pin 7 and Pin 9 must be tied together and driven to a high logic state to activate this function. A continuous self-test does not damage the device.

APPLICATIONS INFORMATION

ACHIEVING OPTIMAL NOISE PERFORMANCE

There are several system level considerations that can have an impact on the noise and accuracy of the ADIS16120. Understanding and managing these factors can influence the behavior of any high performance system.

Supply and Common Considerations

The ADIS16120 provides approximately 1.8 μF of decoupling capacitance. This capacitance is distributed throughout the device and should be taken into account when considering potential noise threats on the power supply lines.

Reference Output

The same reference that is used to calibrate the offset performance of the ADIS16120 is made available for system level use. The REFOUT pin has 1 μF of capacitance, providing a degree of noise filtering. However, careful use of this pin is necessary, considering that any noise or level-shifting influences introduce errors in the output.

Bandwidth Setting

If C_{OUT} is applied to reduce the bandwidth of the ADIS16120 response, it should be placed close to the device. Long cable leads and PCB traces may increase the risk of noise introduction.

USING THE ADIS16120 WITH A SUPPLY RATIOMETRIC ADC

The RATEOUT signal of the ADIS16120 is nonratiometric; that is, neither the null voltage nor the rate sensitivity is proportional to the supply. Instead, they are nominally constant for dc supply changes within the 4.75 V to 5.25 V operating range. If the ADIS16120 is used with a supply ratiometric ADC, the 2.5 V output of the ADIS16120 can be converted and used to make corrections in software for the supply variations.

SECOND-LEVEL ASSEMBLY

The ADIS16120 is designed to be mounted with the header pins either facing up (bulkhead mount) or facing down (printed circuit board mount). In either case, the mating socket should be a Samtec part number: CLM-112-02-L-D-A or equivalent. This family of connectors offers multiple configurations for use in mating to the ADIS16120. Consult the manufacturer reference material if this connector does not match system level requirements. The recommended pad/hole layout for this socket is shown in Figure 16. Use the alignment pins identified in this figure, along with either Figure 17 or Figure 18, to design an appropriate interface for the ADIS16120. Note that to meet worst-case dimensional tolerances of the entire package, the header pins extend beyond the height of the package, requiring the mating PCB to have holes to prevent the bottoming-out of the ADIS16120 pins. Without the holes, a bottom-out event places the ADIS16120 under stress, which can affect accuracy performance. Also, in either mounting configuration, ensure that the ADIS16120 is firmly mounted to prevent additional mechanical vibration.

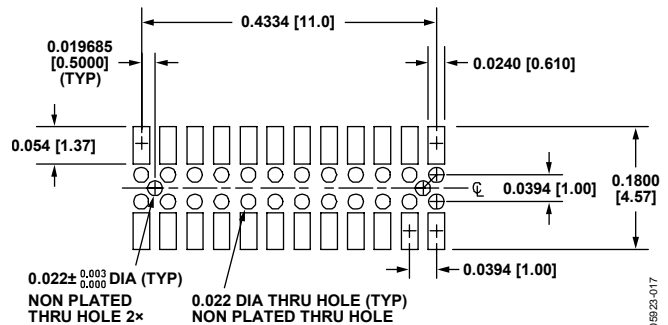

Figure 16. Mating Socket Recommended Pad Layout
Dimensions are shown in inches (millimeters)

OUTLINE DIMENSIONS

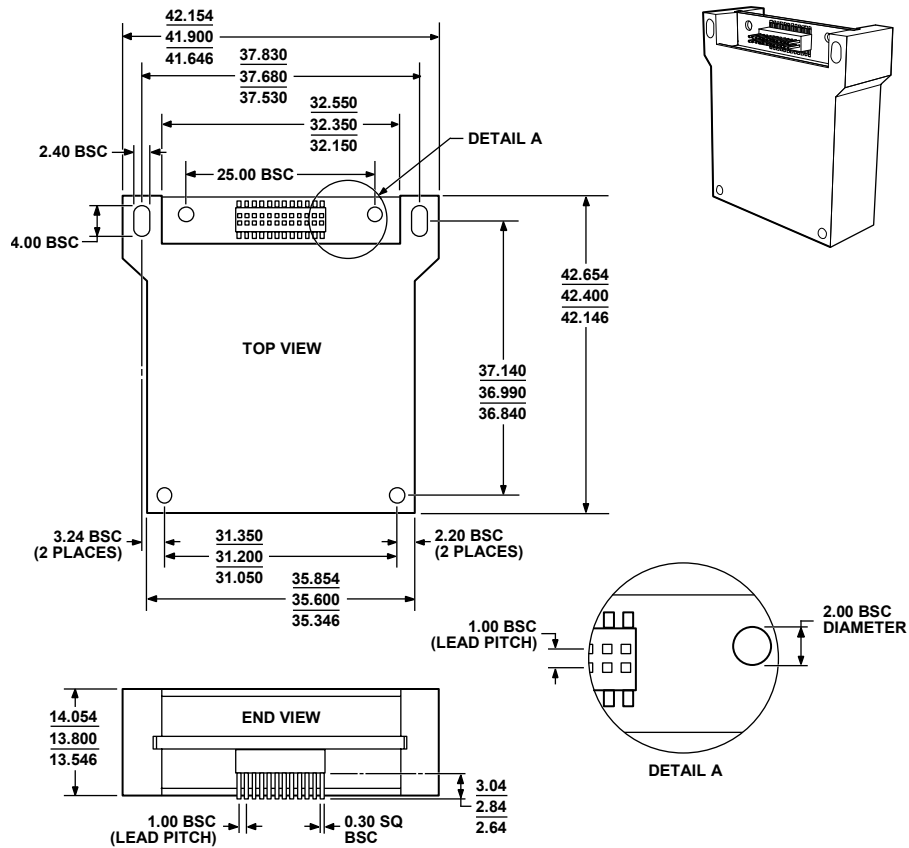

Figure 20. ADIS16120 PCB Module with Connector Interface (ML-24-1)
Dimensions shown in millimeters

092707-B

ORDERING GUIDE

Model	Temperature Range	Package Description	Package Option
ADIS16120AML	-40°C to +85°C	PCB Module with Connector Interface	ML-24-1

ADIS16120

NOTES