



# Audio Roles in Final Cut Pro

White Paper  
November 2020

# Contents

<b>Introduction</b>	<b>4</b>
<b>The Function of Roles</b>	<b>5</b>
<b>Role Assignment</b>	<b>6</b>
Role Assignment in Final Cut Pro	6
Overriding Automatic Role Assignment During Import	8
Assigning Roles Using iXML Track Data	9
<b>Working with Roles in a Library</b>	<b>10</b>
Deleting Roles	11
Deleting Subroles	11
Renaming Roles	12
Renaming Subroles	12
Merging Subroles	13
Moving Subroles	13
<b>Role Components in Container Clips</b>	<b>14</b>
About Channel-Based Components	14
About Role-Based Components	15
Compound Clips	16
Multicam Clips	18
Synced Clips	18
Best Practices	18

## Contents

<b>Audio Signal Flow</b>	<b>19</b>
Clip Signal Flow in Final Cut Pro	19
Applying Clip-Level Effects	20
Best Practices	21
Working with Clips That Mix Down	21
Nesting Mixdown Clips Inside Container Clips	23
<b>Conclusion</b>	<b>25</b>
<b>Glossary</b>	<b>26</b>

# Introduction

Final Cut Pro 10.3 introduced enhancements to audio and role handling, as well as significant changes to Compound clips, Multicam clips, and Synced clips. This white paper explains the benefit of these changes and how they impact your existing workflows.

For comprehensive information about Final Cut Pro, see the [Final Cut Pro User Guide](#).

# The Function of Roles

Audio roles harness the power of modern and flexible metadata to help you better manage a traditional track-based editing process. For example, you don't have to take time on every edit to make sure all of the dialogue audio is patched and edited onto audio tracks 1 through 8 in the timeline—the roles metadata places the audio clips in exactly the right place. This maximizes your computer's screen real estate and makes editing on laptops much more efficient. Each role has a unique color, creating a visual layout in the timeline that can be understood at a glance.

Roles are created automatically when you import clips, but you can also assign roles manually during the organizing and editing stages of a project. You can create custom roles, and you can create subroles within a role to further organize your clips. When it comes time to deliver a project under pressure, roles make audio mixing and the final export faster, simpler, and more dependable.

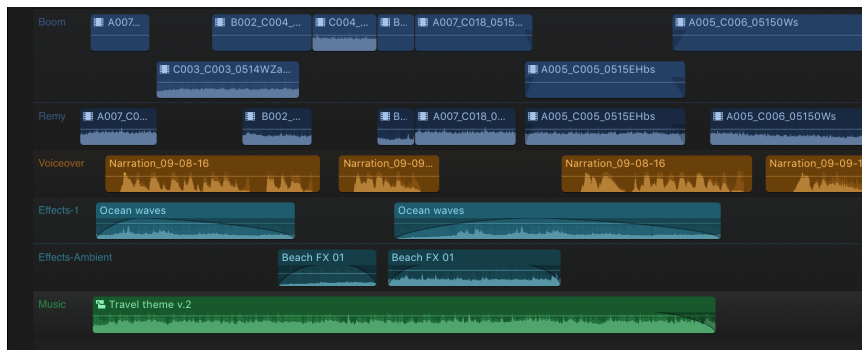

**Audio roles in the timeline**

# Role Assignment

Assigning roles is an important first step to organizing your source material. Time spent assigning roles at the beginning of a project and checking role assignments whenever new material arrives will pay off in important ways.

## Role Assignment in Final Cut Pro

In Final Cut Pro 10.3 or later, audio role assignment is handled differently than in previous versions. Audio components represent the individual channels of audio embedded in a clip, and they can be revealed or hidden over the course of an edit. In previous versions of Final Cut Pro, audio components could have a parent role assigned to them (for example, Dialogue, Effects, or Music). In Final Cut Pro 10.3 or later, only subroles can be assigned to audio components. When you upgrade a library to Final Cut Pro 10.3 or later, any parent roles assigned to audio components are automatically converted to subroles.

## Role Assignment

When clips are imported, Final Cut Pro now assigns a unique subrole to every component. In previous versions of Final Cut Pro, a four-channel audio clip would be imported as follows:

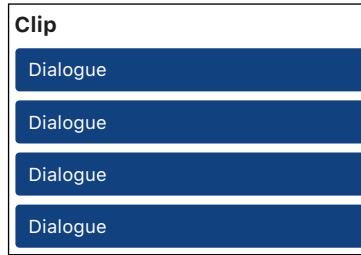

### Final Cut Pro 10.2–10.2.3

Because Final Cut Pro always assigns unique subroles, the same clip is now imported as follows:

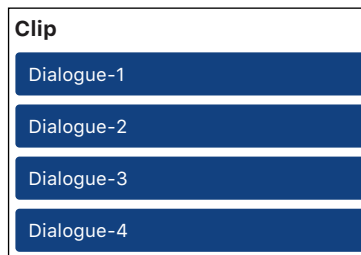

### Final Cut Pro 10.3 or later

Components with the same role assignment have a number appended to the role name.

## Overriding Automatic Role Assignment During Import

Final Cut Pro assigns roles on import according to metadata detected when analyzing a clip. For example, a song imported from Music is assigned a Music role, and a sound effect imported from the sound effects library is assigned an Effects role.

In Final Cut Pro 10.3 or later, you can override the automatic role assignment process so that every imported audio component is assigned a role of your choosing. You can specify one of the three preset audio roles or create a custom role.

The Import preferences include an Assign Role pop-up menu, set to Automatically by default. The default setting behaves exactly the same as in previous versions of Final Cut Pro.

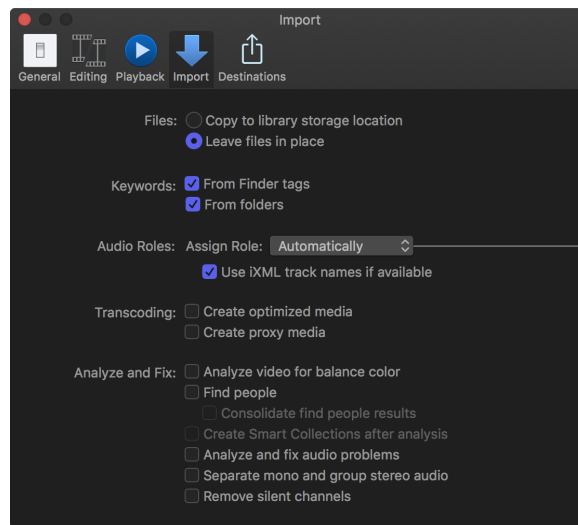

When Automatically is chosen, default roles are assigned automatically during import.

To override the automatic assignment with a preset or custom role, choose it from the Assign Role pop-up menu. (You can create any number of custom roles using the role editor.) For example, choosing the custom role Soundtracks and then importing a song from Music causes the song to be tagged with a Soundtracks subrole rather than a default Music-1 subrole.

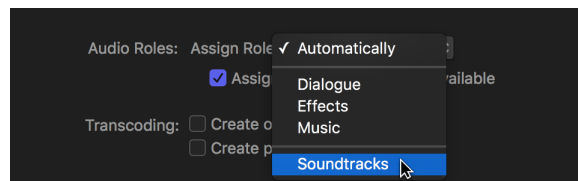



## Assigning Roles Using iXML Track Data

Many professional audio field recorders allow a sound recordist to embed iXML track name metadata into their audio recordings while on set. This iXML metadata can be the type of microphone or the name of the person being recorded. You can assign roles based on the iXML metadata using the new “Assign iXML track names if available” checkbox in Import preferences.

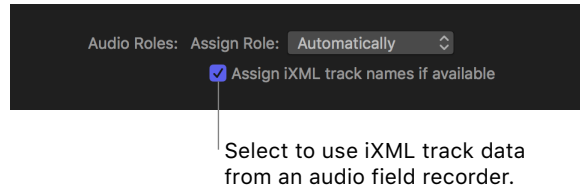

When this checkbox is selected, Final Cut Pro analyzes imported audio for iXML metadata tags, creates subroles with the names embedded by the audio field recorder, and assigns the subroles to the corresponding components in the imported clips.

The Assign Role setting and the “Assign iXML track names if available” setting can work together. For example, you can create a custom role such as Location Sound using the role editor and then choose that role from the Assign Role pop-up menu. If the “Assign iXML track names if available” checkbox is selected, imported clips are assigned the Location Sound role, with custom audio channel names coming from the iXML file.

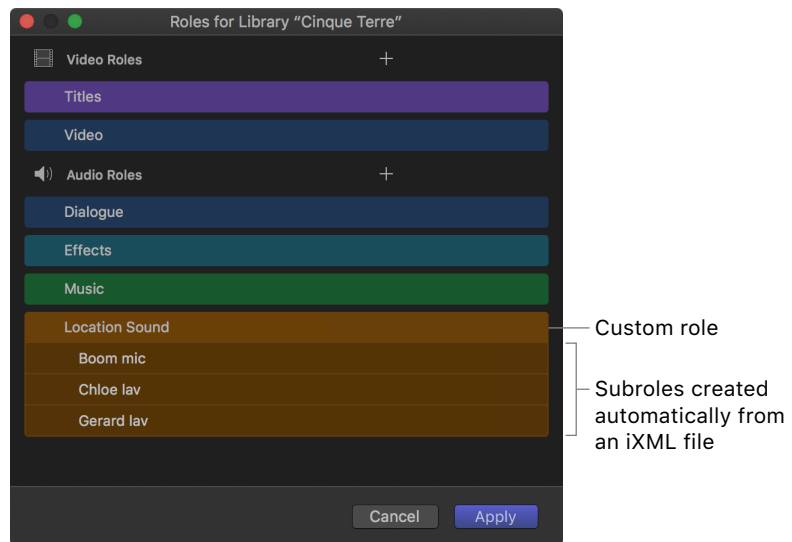

All of this occurs automatically on import, and the settings are retained for future import operations.

# Working with Roles in a Library

In previous versions of Final Cut Pro, a single set of roles was shared across all libraries. In Final Cut Pro 10.3 or later, you can define roles for an individual library. New role-management features include the ability to delete and rename roles and subroles, merge subroles, and move subroles between parent roles. These features allow you to maintain lean, curated role sets for each library. You can also apply batch changes to roles across entire libraries.

It's important to understand how these changes affect every clip and project in a library. Become familiar with the rules detailed below before taking advantage of role-management features, especially before updating large libraries that contain important work.

## Deleting Roles

Keep the following in mind when deleting roles:

- Default roles that are reserved by the system can't be deleted (the default roles are Titles, Video, Dialogue, Effects, Music, and Mixed Audio).
- Only custom roles that you create can be deleted.
- Deleting a role removes the role and all of its subroles.
- Clips that have been tagged with a custom role revert to one of the default roles when the custom role is deleted.

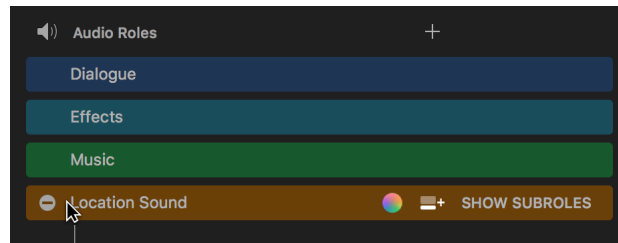

In the role editor, move the pointer over the name of a custom role, then click the Delete button that appears.

## Deleting Subroles

Keep the following in mind when deleting subroles:

- Default subroles that are reserved by the system can't be deleted (for example, Dialogue-1, Effects-1, Music-1, and so on).
- Deleting a subrole removes the subrole from the role throughout the library.
- Only custom subroles that you create can be deleted.
- Clips that have been tagged with a custom subrole revert to one of the default subroles when the custom subrole is deleted.



## Renaming Roles

Keep the following in mind when renaming roles:

- Default roles that are reserved by the system can't be renamed (the default roles are Titles, Video, Dialogue, Effects, Music, and Mixed Audio).
- Only custom roles that you create can be renamed.
- Renaming a role also renames the default subroles throughout that library.
- Existing subroles that you've created are not changed when a parent role is renamed.
- You can't use a name reserved by the system (such as Titles, Video, Dialogue, Effects, Music, or Mixed Audio).



## Renaming Subroles

Keep the following in mind when renaming subroles:

- All subroles can be renamed, including default and custom subroles.
- Renaming a subrole updates every clip using that subrole in the library.



## Merging Subroles

Keep the following in mind when merging subroles:

- You can merge any subrole into another subrole by dragging it in the role editor.
- When a subrole is merged into another subrole, all clips tagged with the source subrole change to the target subrole across every clip in the library.

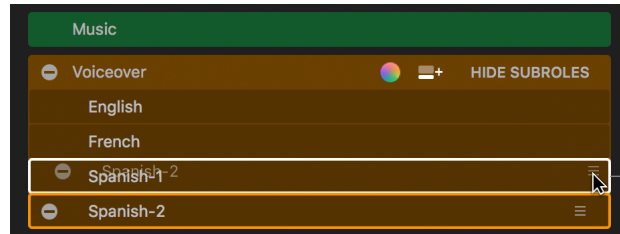

Drag any subrole in the role editor to merge it into another subrole.

## Moving Subroles

Keep the following in mind when moving subroles:

- Any subrole can be moved into a different parent role.
- When you move a subrole, clips that have been tagged with that subrole stay the same, but their parent role is updated across every clip in the library.

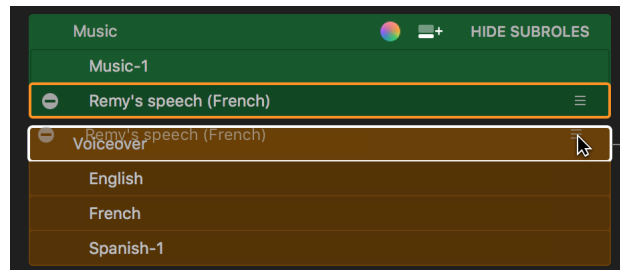

Drag the subrole to move it to its new parent role.

# Role Components in Container Clips

Compound clips, Multicam clips, and Synced clips are called *container clips* because they're made up of other clips. In Final Cut Pro 10.3 or later, container clips generate special audio components, called *role components*, based on the role assignments within the clip.

## About Channel-Based Components

In previous versions of Final Cut Pro, all clips had channel-based audio components. For example, a clip with audio and video that was recorded with four audio channels had four audio components, each assigned the Dialogue role.

Guidelines for channel-based components:

- The order of the channel-based components is the same as the original track order.
- Multiple channel-based components share the same role name.

In Final Cut Pro 10.3 or later, only standard clips from cameras, sound recorders, and audio libraries continue to use channel-based components.

## About Role-Based Components

In previous versions of Final Cut Pro, Compound clips, Multicam clips, and Synced clips also used channel-based components. But unlike standard clips, these container clips hold other clips. They're also much more likely to have changes and edits made to the contents inside the clip. The clips inside a container clip could even include *reference clips* (other Compound or Multicam clips), increasing the probability that the contents of the clip could change over time.

In Final Cut Pro 10.3 or later, Compound clips, Multicam clips, and Synced clips generate role components, which are based on the role assignments inside a container clip. There's one role component for each subrole found inside the container clip. A role component is like a traditional audio bus—if multiple audio clips share the same subrole, their audio is mixed together into a single role component. If subroles inside the clip change or clips are added to the container clip, the role components are updated to show an accurate snapshot of the roles being used inside the clip.

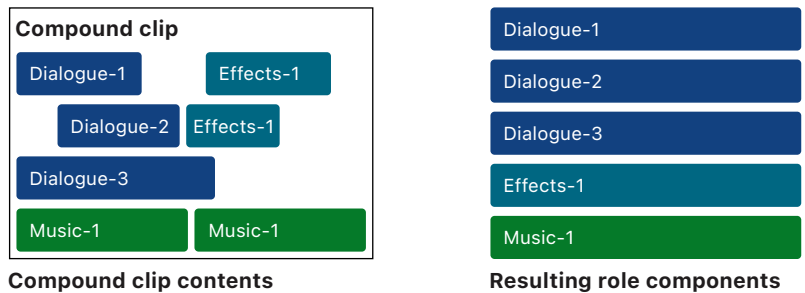

Guidelines for role components:

- Each role inside a container clip results in a role component.
- Audio clips that share a role are mixed together and combined into the same role component. Mixing together audio clips that share the same role is like mixing with a traditional audio bus.
- Role components are updated automatically if the container clip contents change. This could be because a reference clip (such as a Compound clip or Multicam clip) inside the container clip was changed elsewhere in the library.
- You can't make role assignment changes to the container clip itself. To change role assignments, you must modify the clips inside the container clip.

## Compound Clips

Compound clips have a special setting in the Audio inspector that allows you to choose whether role components are generated based on roles or subroles.

Click the pop-up menu and choose an option.

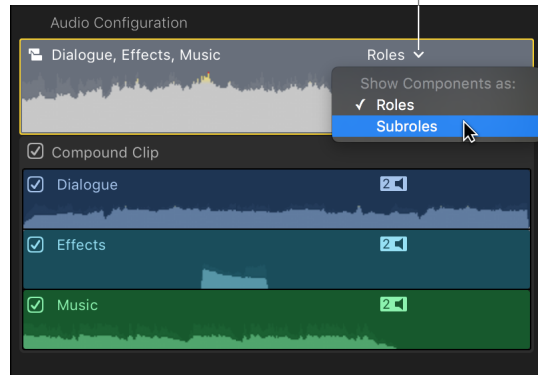

### Show Components as Roles

When Show Components as Roles is chosen in the Audio inspector, the role components in the Compound clip are created from the parent roles assigned inside the clip. This is the default setting when a Compound clip is created as the topmost object in a timeline (not nested inside another clip).

### Show Components as Subroles

When Show Components as Subroles is chosen in the Audio inspector, each role component is based on a subrole found in the Compound clip, not on a parent role. This is the default setting when a Compound clip is created in the browser, or when a Compound clip is created while nested inside another Compound clip.



## Example

A typical Final Cut Pro project contains clips assigned to various Dialogue subroles, some clips assigned to Effects subroles, and perhaps a clip assigned to Music.

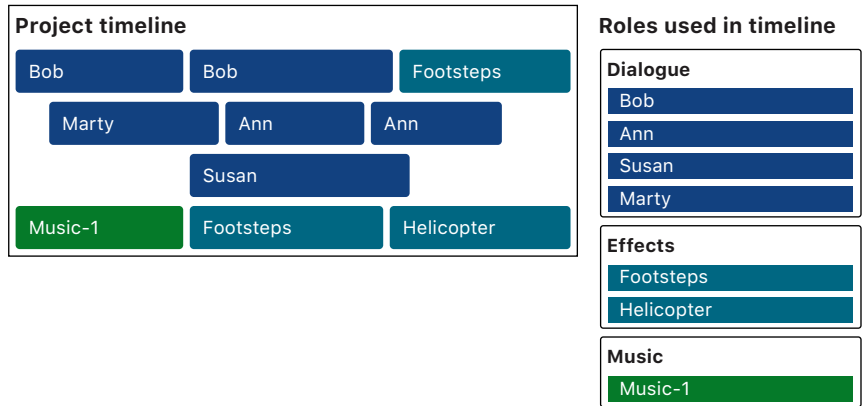

If you wrap the entire project in a Compound clip, the clip setting defaults to Show Components as Roles. This means the Compound clip has role components that correspond to the parent roles assigned inside the clip—in this case, Dialogue, Effects, and Music.

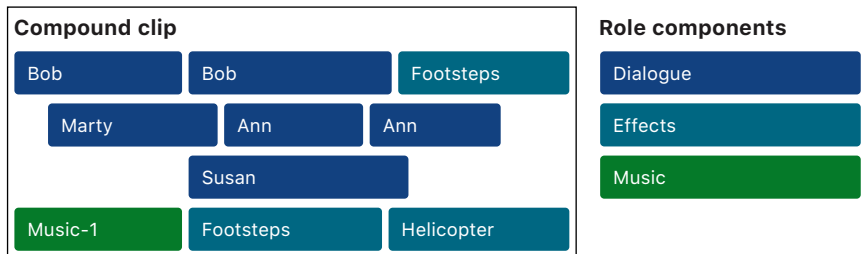

Clicking the Show Audio Lanes button in the timeline index displays the components in the timeline. You can then apply volume changes and audio effects to the role components to affect the entire mix while finishing the project.

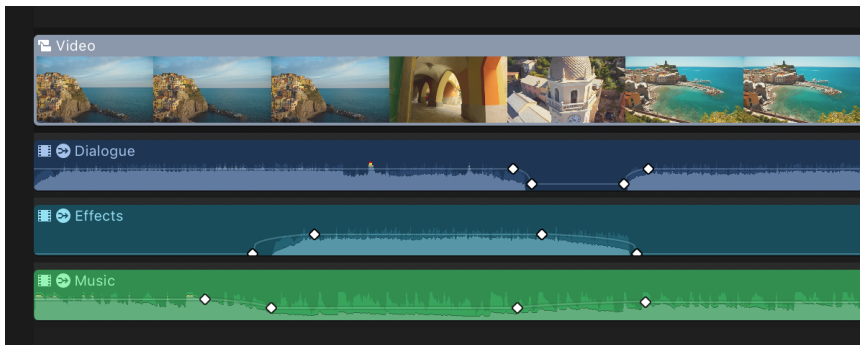

## Multicam Clips

Multicam clips behave slightly differently than Compound clips; they generate a unique set of role components for each multicam angle.

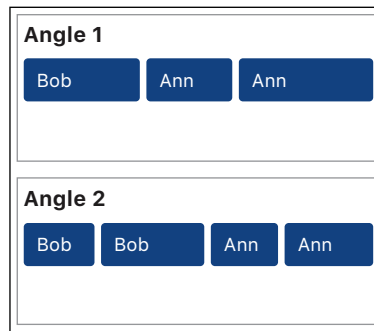

Multicam clip

### Angle 1 role components



### Angle 2 role components



## Synced Clips

Synced clips generate two sets of role components: one for the primary storyline and one for all connected audio.

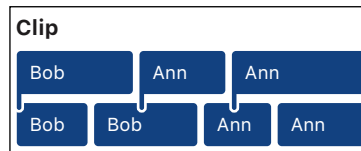

Synced clip

### Storyline role components



### Connected role components



## Best Practices

- Assign meaningful and unique subroles to the audio in all of your clips.
- Final Cut Pro automatically assigns unique roles on import. You can assign the same roles to audio components within a clip, but it's important to remember that audio for all the clips with the same role assignment will be combined for output when the clips are placed inside container clips.

# Audio Signal Flow

With the enhanced role support in Final Cut Pro 10.3 or later, managing audio signal flow is more streamlined than ever.

## Clip Signal Flow in Final Cut Pro

Historically, clips in Final Cut Pro with multiple audio components mixed their components together into a single audio output per clip. However, this attribute of the Final Cut Pro clip signal flow complicated keeping audio separated by role.



**Final Cut Pro 10.2–10.2.3**

By default, clips in Final Cut Pro no longer mix their components together. Instead, every clip maintains multiple audio outputs—one per assigned subrole.



**Final Cut Pro 10.3 or later**

## Applying Clip-Level Effects

If you want to apply an effect to all the components in a clip, you can apply the effect at the *clip level* (to the entire clip). However, because clips with multiple components no longer have a single audio output, there's no destination for clip effects in the signal flow.



**Clip without effects**

When an effect is applied at the clip level, the multiple audio components are mixed together through the applied effect. Because clip-level effects cause audio to be mixed together, they are referred to as *mixdown effects*.



**Clip with effects**

To maintain as much role separation as possible, the application differentiates between two cases when applying clip effects: clips with components from the same parent role and clips with components from multiple parent roles.

### Clips with Components from a Single Parent Role

Many clips with multiple components have subroles assigned from the same parent role (for example, all Dialogue subroles). When a clip-level effect is applied, the subrole components are combined into a single audio output. Final Cut Pro automatically routes the audio to the common parent role shared by the components (in this case, Dialogue).

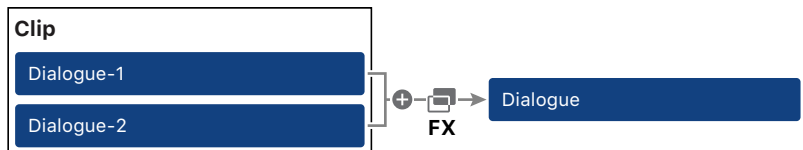

**Clip with effects**

**Role component**

## Clips with Components from Multiple Parent Roles

Some clips have components with subrole assignments from different parent roles (for example, some Dialogue subroles and some Effects subroles). When a clip-level effect is applied in this case, the subrole components are combined into a single audio output. Because the components are from different roles, Final Cut Pro uses a special Mixed Audio parent role. The clip's consolidated audio output is automatically routed to this role, which prevents other dialogue and effects clips from accidentally being exported in the same role.

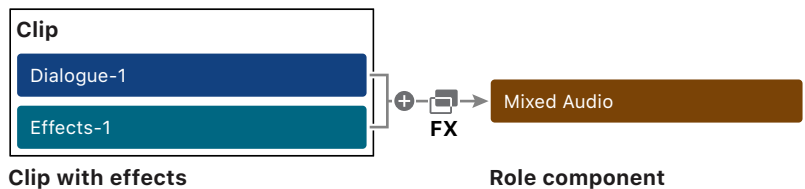

## Best Practices

- When possible, add audio effects to individual components instead of to the entire clip.
- Keep the subroles in a clip assigned within the same role to ensure the simplest grouping of roles.
- Remember that mixdown effects behave differently depending on the role assignments in the clip they're applied to.

## Working with Clips That Mix Down

Final Cut Pro displays a badge on clips that mix down. When you see this badge on a clip, it means that the clip combines its components into a consolidated audio output.



Final Cut Pro still provides access to the individual audio components in these clips, so applying clip-level effects doesn't impact your ability to continue editing the audio components.

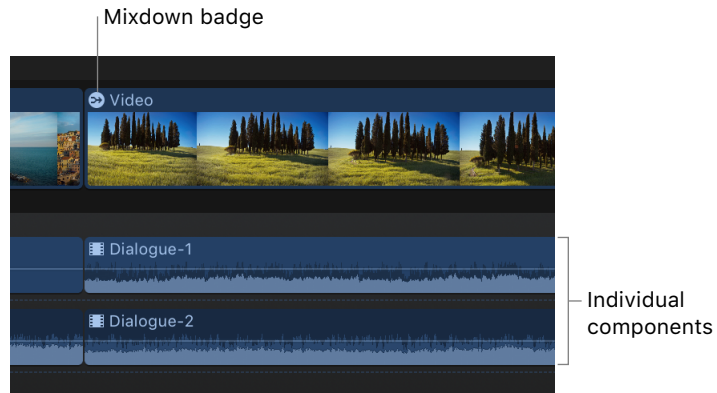

The clip summary at the top of the Audio Configuration section of the Audio inspector indicates the role outputs per clip.

After effects are applied at the clip level, a badge appears to indicate that the clip is mixing down, and the text is updated to show that the clip now has a single audio output (in this case, Dialogue).

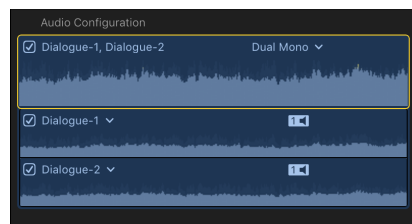

Before effects are applied

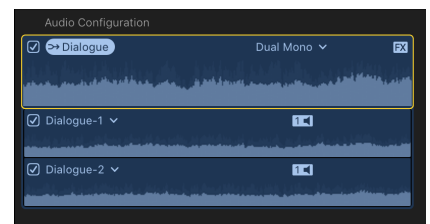

After effects are applied

The multi-role clip in the example below shows role outputs of Dialogue-1 and Effects-1 before clip effects are applied. After effects are applied at the clip level, the mixdown badge appears, and the clip summary shows that the clip's audio output is being routed to the new Mixed Audio parent role.

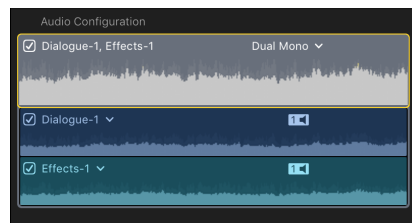

Before effects are applied

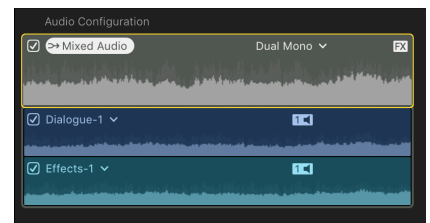

After effects are applied

## Nesting Mixdown Clips Inside Container Clips

When a clip that mixes down to the Mixed Audio role is placed inside a container clip (a Compound clip, Multicam clip, or Synced clip), a Mixed Audio role component appears.

In the example below, the Compound clip contains two clips with mixed roles, but neither one is mixing down. The role assignments in the clips are combined into Music-1 and Effects-1 role components. This will result in an export that has only Music and Effects roles.

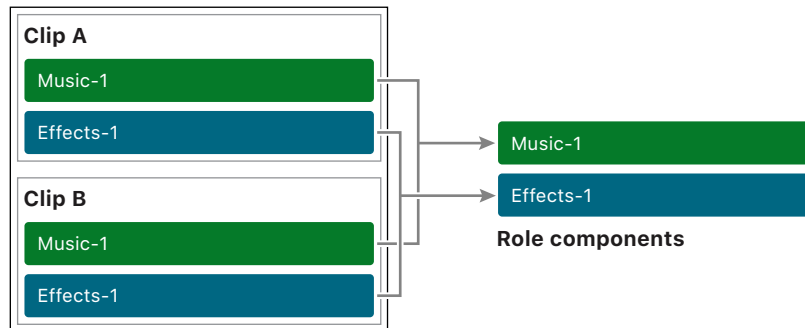

**Compound clip**

In the following example, the Compound clip contains two clips, and one is mixing down to a Mixed Audio role because it has an audio effect applied at the clip level. The other clip inside the Compound clip does not have effects applied. The Compound clip has three role components: Music-1, Effects-1, and Mixed Audio. This will result in an export that has Music, Effects, and Mixed Audio roles.

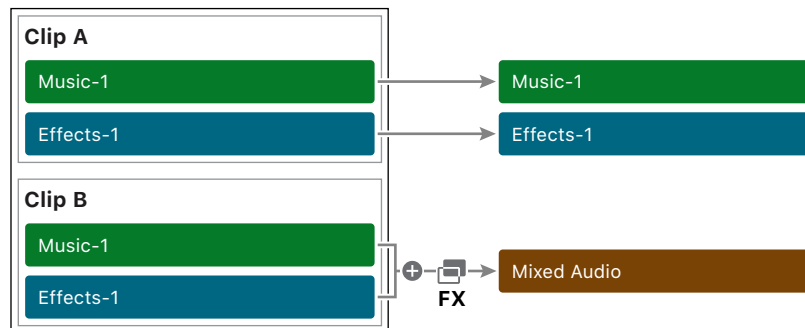

**Compound clip**

**Role components**

When container clip contents mix down because of applied effects, Final Cut Pro displays the mixdown badge on the resulting role component. This helps you understand the container clip contents and the underlying signal flow of your role components.

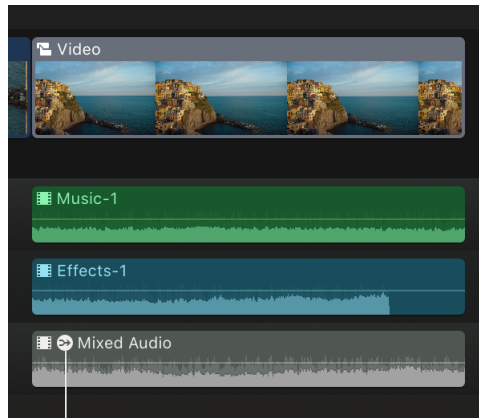

Mixdown badge

Similarly, when a Compound clip is set to show components as roles, all of the role components display the mixdown badge. This is because the subroles inside the clip are being mixed down to their parent roles.

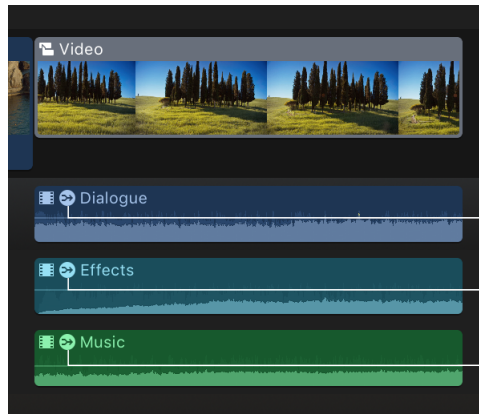

Mixdown badges



# Conclusion

Audio roles and subroles are important to advanced audio signal flow, but in normal editing they shouldn't get in the way of the creative process. Role colors and a special timeline layout let you understand your project's audio at a glance, so you can see exactly how your story is being told through the use of sound. Audio roles help you get the best results from your audio mixing, and, as you dive in deeper, they give you more control over organizing and exporting.

# Glossary

**audio components** Individual audio channels in a clip that can be revealed or hidden.

**channel components** Audio components in standard clips that are defined based on the channel content of the contained audio.

**container clips** Compound clips, Multicam clips, or Synced clips that are created inside Final Cut Pro and contain standard clips or other container clips.

**mixdown clips** Clips with more than one audio component that have effects applied at the clip level, causing the audio to mix down to a single audio output.

**multi-role clips** Clips with subroles from more than one parent role.

**reference clips** Compound clips and Multicam clips are reference clips. Changes made to the contents of a reference clip affect every instance of the clip across the entire library, even in other projects.

**role components** Audio components in container clips that are defined based on the role assignments of the contained audio.

**role outputs** The audio outputs for a clip, which appear as role components when the clip is nested inside a container clip.

**standard clips** Clips from a camera, audio recording device, or similar source that are imported into Final Cut Pro and don't contain other clips.