

XLamp® XH-G LED

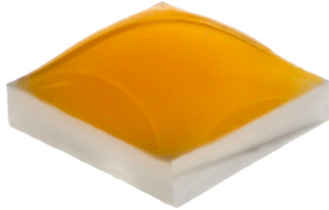

PRODUCT DESCRIPTION

Unlike common plastic packages, XLamp XH LEDs use a ceramic package to deliver the unique combination of high performance and reliability not available elsewhere in mid-power LEDs. The ceramic-based XH LEDs are designed to deliver the long L70 lifetimes of Cree LED's other high-power LEDs, such as XP or XT LEDs, as well as industry-leading LED efficacy levels.

Optimized for fluorescent replacement lighting applications, such as troffers and panel lights, where high efficacy, long lifetime and smooth appearance are critical, the XH LEDs allow lighting manufacturers to offer products that meet the lifetime expectations of LED technology.

FEATURES

- Package size: 3.0 X 3.0 mm
- Available in white (2200 K and 2600 K - 8300 K), 70-minimum CRI cool white, 80-minimum CRI white and 85- and 90-minimum CRI warm white
- 350 mA maximum drive current
- Viewing angle: 130°
- Reflow solderable - JEDEC J-STD-020C compatible
- Unlimited floor life at ≤ 30 °C/85% RH
- RoHS and REACH compliant
- UL® recognized component (E349212)

TABLE OF CONTENTS

| | |
|---|----|
| Characteristics | 2 |
| Flux Characteristics | 3 |
| Relative Spectral Power Distribution | 6 |
| Relative Flux vs. Junction Temperature..... | 6 |
| Electrical Characteristics..... | 7 |
| Relative Flux vs. Current | 7 |
| Typical Spatial Distribution..... | 8 |
| Thermal Design | 8 |
| Performance Groups – Luminous Flux..... | 9 |
| Performance Groups – Chromaticity..... | 9 |
| Standard Cool White Kits Plotted on ANSI | |
| Standard Chromaticity Regions | 12 |
| Standard Warm and Neutral White Kits | |
| Plotted on ANSI Standard Chromaticity | |
| Regions | 13 |
| Standard Chromaticity Kits | 14 |
| Bin and Order Code Format..... | 15 |
| Reflow Soldering Characteristics..... | 16 |
| Notes | 17 |
| Mechanical Dimensions | 19 |
| Tape and Reel..... | 20 |
| Packaging..... | 22 |



Cree LED / 4001 E. Hwy. 54, Suite 2000 / Durham, NC 27709 USA / +1.919.313.5330 / www.cree-led.com

CHARACTERISTICS

| Characteristics | Unit | Minimum | Typical | Maximum |
|---|---------|---------|----------|---------|
| Thermal resistance, junction to solder point ⁹ | °C/W | | 14 | |
| Viewing angle (FWHM) | degrees | | 130 | |
| Temperature coefficient of voltage | mV/°C | | -1.2 | |
| ESD withstand voltage (HBM per Mil-Std-883D) | | | Class 3B | |
| DC forward current | mA | | | 350 |
| Reverse voltage | V | | | 1 |
| Forward voltage (@ 65 mA, 25 °C) | V | | 2.9 | 3.4 |
| LED junction temperature | °C | | | 150 |

Note:

- ◇ Thermal resistance measurement was performed per the JEDEC JESD51-14 standard. See the [Thermal Resistance Measurement application note](#) for more details.

FLUX CHARACTERISTICS (T_J = 25 °C)

The following table provides several base order codes for XLamp XH-G LEDs. For a complete description of the order-code nomenclature, please consult the Bin and Order Code Format section (page 15).

| Chromaticity | | Minimum Luminous Flux (lm) @ 65 mA | | Calculated Minimum Luminous Flux (lm)* | Order Codes | | |
|-----------------------------------|--------|------------------------------------|-----------|--|--------------------------|--------------------------|--------------------------|
| Kit | CCT | Code | Flux (lm) | 300 mA | No Minimum CRI | 70 CRI Minimum | 80 CRI Minimum |
| ANSI Cool White (5000 K – 8300 K) | | | | | | | |
| E1 | 6500 K | K2 | 30.6 | 115 | XHGAWT-00-0000-00000L0E1 | XHGAWT-00-0000-00000B0E1 | |
| | | J3 | 26.8 | 101 | XHGAWT-00-0000-00000LXE1 | XHGAWT-00-0000-00000BXE1 | XHGAWT-00-0000-00000HXE1 |
| 50 | 6000 K | K2 | 30.6 | 115 | XHGAWT-00-0000-00000L050 | XHGAWT-00-0000-00000B050 | |
| | | J3 | 26.8 | 101 | XHGAWT-00-0000-00000LX50 | XHGAWT-00-0000-00000BX50 | XHGAWT-00-0000-00000HX50 |
| 51 | 6000 K | K2 | 30.6 | 115 | XHGAWT-00-0000-00000L051 | XHGAWT-00-0000-00000B051 | |
| | | J3 | 26.8 | 101 | XHGAWT-00-0000-00000LX51 | XHGAWT-00-0000-00000BX51 | XHGAWT-00-0000-00000HX51 |
| 53 | 5700 K | K2 | 30.6 | 115 | XHGAWT-00-0000-00000L053 | XHGAWT-00-0000-00000B053 | |
| | | J3 | 26.8 | 101 | XHGAWT-00-0000-00000LX53 | XHGAWT-00-0000-00000BX53 | XHGAWT-00-0000-00000HX53 |
| E2 | 5700 K | K2 | 30.6 | 115 | XHGAWT-00-0000-00000L0E2 | XHGAWT-00-0000-00000B0E2 | |
| | | J3 | 26.8 | 101 | XHGAWT-00-0000-00000LXE2 | XHGAWT-00-0000-00000BXE2 | XHGAWT-00-0000-00000HXE2 |

- Notes**
- Cree LED maintains a tolerance of ±7% on flux and power measurements, ±0.005 on chromaticity (CCx, CCy) measurements and a tolerance of ±2 on CRI measurements. See the Measurements section (page 17).
 - XLamp XH-G LED order codes specify only a minimum flux bin and not a maximum. Cree LED may ship reels in flux bins higher than the minimum specified by the order code without advance notice. Shipments will always adhere to the chromaticity bin restrictions specified by the order code.
 - Typical CRI for Neutral White, 3700 K - 5000 K CCT is 75.
 - Typical CRI for Warm White, 2600 K - 3700 K CCT is 80.
 - Minimum CRI for 70-CRI Minimum Cool White is 70.
 - Minimum CRI for 80-CRI Minimum White is 80.
 - Minimum CRI for 85-CRI Minimum White is 85.
 - Minimum CRI for 90-CRI Minimum White is 90.
 - * Flux values @ 300 mA are calculated and for reference only.

FLUX CHARACTERISTICS (T_j = 25 °C) - CONTINUED

| Chromaticity | | Minimum Luminous Flux (lm) @ 65 mA | | Calculated Minimum Luminous Flux (lm)* | Order Codes | | |
|--------------------------------------|--------|------------------------------------|-----------|--|--------------------------|--------------------------|--------------------------|
| Kit | CCT | Code | Flux (lm) | 300 mA | 70 CRI Minimum | 75 CRI Typical | 80 CRI Minimum |
| ANSI Neutral White (3700 K – 5000 K) | | | | | | | |
| E3 | 5000 K | K2 | 30.6 | 46.0 | XHGAWT-00-0000-00000B0E3 | XHGAWT-00-0000-00000L0E3 | |
| | | J3 | 26.8 | 40.4 | XHGAWT-00-0000-00000BXE3 | XHGAWT-00-0000-00000LXE3 | XHGAWT-00-0000-00000HXE3 |
| F4 | 4750 K | K2 | 30.6 | 46.0 | XHGAWT-00-0000-00000B0F4 | | |
| | | J3 | 26.8 | 40.4 | XHGAWT-00-0000-00000BXF4 | XHGAWT-00-0000-00000LXF4 | XHGAWT-00-0000-00000HXF4 |
| E4 | 4500 K | K2 | 30.6 | 46.0 | XHGAWT-00-0000-00000B0E4 | | |
| | | J3 | 26.8 | 40.4 | XHGAWT-00-0000-00000BXE4 | XHGAWT-00-0000-00000LXE4 | XHGAWT-00-0000-00000HXE4 |
| F5 | 4300 K | K2 | 30.6 | 46.0 | XHGAWT-00-0000-00000B0F5 | | |
| | | J3 | 26.8 | 40.4 | XHGAWT-00-0000-00000BXF5 | XHGAWT-00-0000-00000LXF5 | XHGAWT-00-0000-00000HXF5 |
| E5 | 4000 K | K2 | 30.6 | 46.0 | XHGAWT-00-0000-00000B0E5 | | XHGAWT-00-0000-00000H0E5 |
| | | J3 | 26.8 | 40.4 | XHGAWT-00-0000-00000BXE5 | XHGAWT-00-0000-00000LXE5 | XHGAWT-00-0000-00000HXE5 |

- Notes**
- Cree LED maintains a tolerance of ±7% on flux and power measurements, ±0.005 on chromaticity (CCx, CCy) measurements and a tolerance of ±2 on CRI measurements. See the Measurements section (page 17).
 - XLamp XH-G LED order codes specify only a minimum flux bin and not a maximum. Cree LED may ship reels in flux bins higher than the minimum specified by the order code without advance notice. Shipments will always adhere to the chromaticity bin restrictions specified by the order code.
 - Typical CRI for Neutral White, 3700 K - 5000 K CCT is 75.
 - Typical CRI for Warm White, 2600 K - 3700 K CCT is 80.
 - Minimum CRI for 70-CRI Minimum Cool White is 70.
 - Minimum CRI for 80-CRI Minimum White is 80.
 - Minimum CRI for 85-CRI Minimum White is 85.
 - Minimum CRI for 90-CRI Minimum White is 90.
 - * Flux values @ 300 mA are calculated and for reference only.

FLUX CHARACTERISTICS (T_j = 25 °C) - CONTINUED

| Chromaticity | | Minimum Luminous Flux (lm) @ 65 mA | | Calculated Minimum Luminous Flux (lm)* | Order Codes | | | | |
|-----------------------------------|--------|------------------------------------|-----------|--|--------------------------|--------------------------|--------------------------|--------------------------|--------------------------|
| Kit | CCT | Code | Flux (lm) | 300 mA | 70 CRI Minimum | 80 CRI Typical | 80 CRI Minimum | 85 CRI Minimum | 90 CRI Minimum |
| ANSI Warm White (2700 K - 3700 K) | | | | | | | | | |
| F6 | 3700 K | J3 | 26.8 | 101 | XHGAWT-00-0000-00000BXF6 | XHGAWT-00-0000-00000LXF6 | XHGAWT-00-0000-00000HXF6 | | |
| E6 | 3500 K | J3 | 26.8 | 101 | XHGAWT-00-0000-00000BXE6 | XHGAWT-00-0000-00000LXE6 | XHGAWT-00-0000-00000HXE6 | | |
| F7 | 3200 K | J3 | 26.8 | 101 | XHGAWT-00-0000-00000BXF7 | XHGAWT-00-0000-00000LXF7 | XHGAWT-00-0000-00000HXF7 | | |
| | | J2 | 23.5 | 88.6 | | | XHGAWT-00-0000-00000HWF7 | | |
| | | H0 | 18.1 | 68.2 | | | | XHGAWT-00-0000-00000PVF7 | XHGAWT-00-0000-00000UVF7 |
| E7 | 3000 K | J3 | 26.8 | 101 | XHGAWT-00-0000-00000BXE7 | XHGAWT-00-0000-00000LXE7 | XHGAWT-00-0000-00000HXE7 | | |
| | | J2 | 23.5 | 88.6 | | | XHGAWT-00-0000-00000HWE7 | | |
| | | H0 | 18.1 | 68.2 | | | | XHGAWT-00-0000-00000PVE7 | XHGAWT-00-0000-00000UVE7 |
| F8 | 2850 K | J3 | 26.8 | 101 | XHGAWT-00-0000-00000BXF8 | XHGAWT-00-0000-00000LXF8 | XHGAWT-00-0000-00000HXF8 | | |
| | | J2 | 23.5 | 88.6 | | XHGAWT-00-0000-00000LWF8 | XHGAWT-00-0000-00000HWF8 | | |
| | | H0 | 18.1 | 68.2 | | | | XHGAWT-00-0000-00000PVF8 | XHGAWT-00-0000-00000UVF8 |
| E8 | 2700 K | J3 | 26.8 | 101 | XHGAWT-00-0000-00000BXE8 | XHGAWT-00-0000-00000LXE8 | XHGAWT-00-0000-00000HXE8 | | |
| | | J2 | 23.5 | 88.6 | | XHGAWT-00-0000-00000LWE8 | XHGAWT-00-0000-00000HWE8 | | |
| | | H0 | 18.1 | 68.2 | | | | XHGAWT-00-0000-00000PVE8 | XHGAWT-00-0000-00000UVE8 |

- Notes
- Cree LED maintains a tolerance of ±7% on flux and power measurements, ±0.005 on chromaticity (CCx, CCy) measurements and a tolerance of ±2 on CRI measurements. See the Measurements section (page 17).
 - XLamp XH-G LED order codes specify only a minimum flux bin and not a maximum. Cree LED may ship reels in flux bins higher than the minimum specified by the order code without advance notice. Shipments will always adhere to the chromaticity bin restrictions specified by the order code.
 - Typical CRI for Neutral White, 3700 K - 5000 K CCT is 75.
 - Typical CRI for Warm White, 2600 K - 3700 K CCT is 80.
 - Minimum CRI for 70-CRI Minimum Cool White is 70.
 - Minimum CRI for 80-CRI Minimum White is 80.
 - Minimum CRI for 85-CRI Minimum White is 85.
 - Minimum CRI for 90-CRI Minimum White is 90.
 - * Flux values @ 300 mA are calculated and for reference only.

RELATIVE SPECTRAL POWER DISTRIBUTION

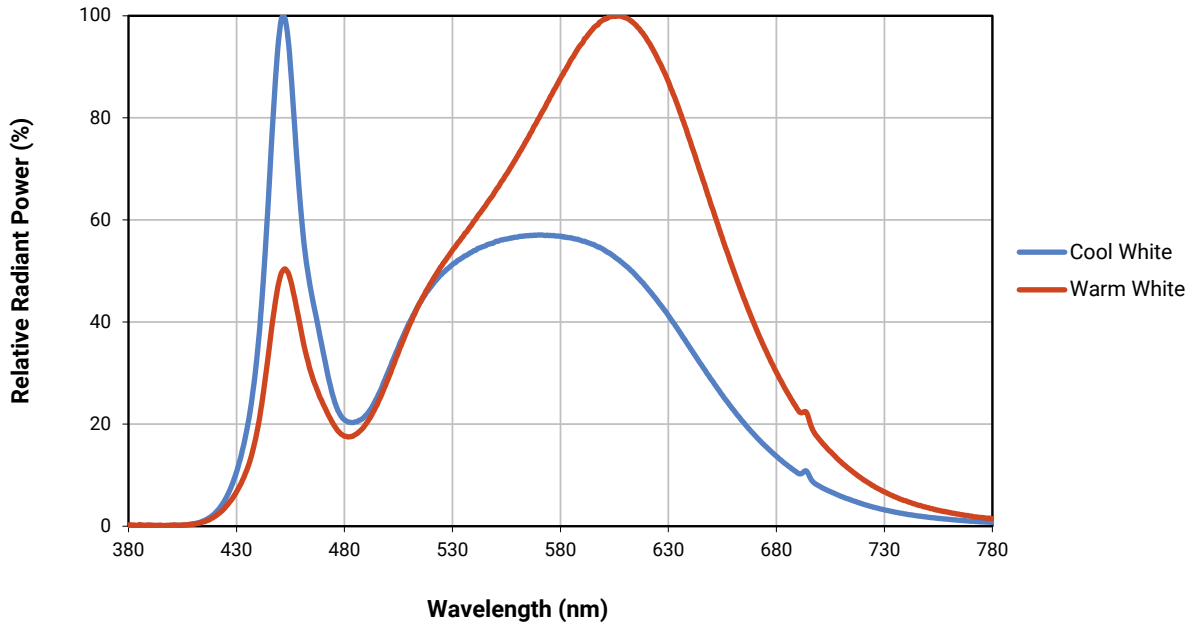

RELATIVE FLUX VS. JUNCTION TEMPERATURE ($I_f = 65 \text{ mA}$)

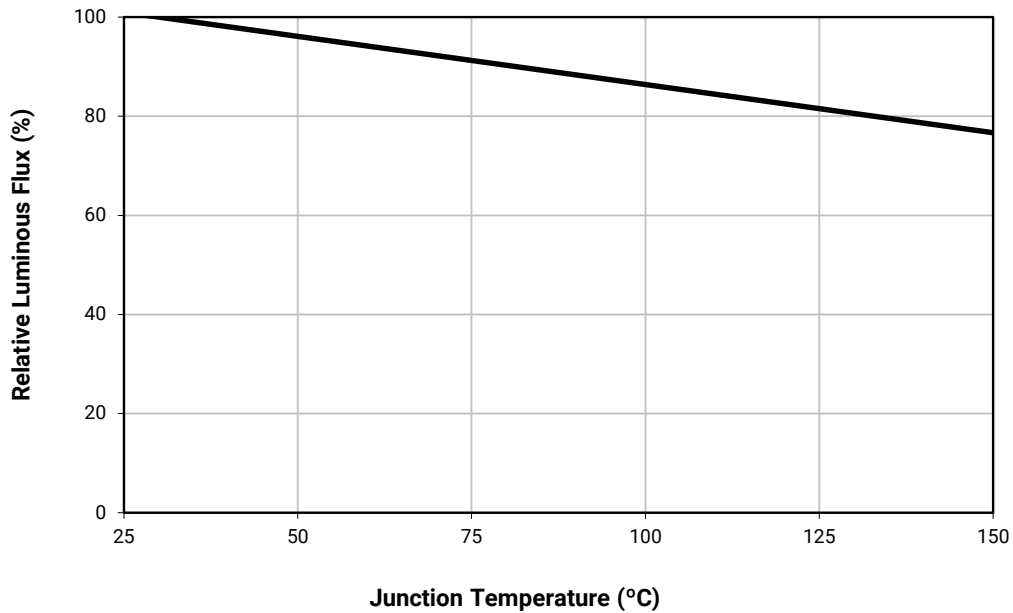

ELECTRICAL CHARACTERISTICS ($T_j = 25\text{ }^\circ\text{C}$)

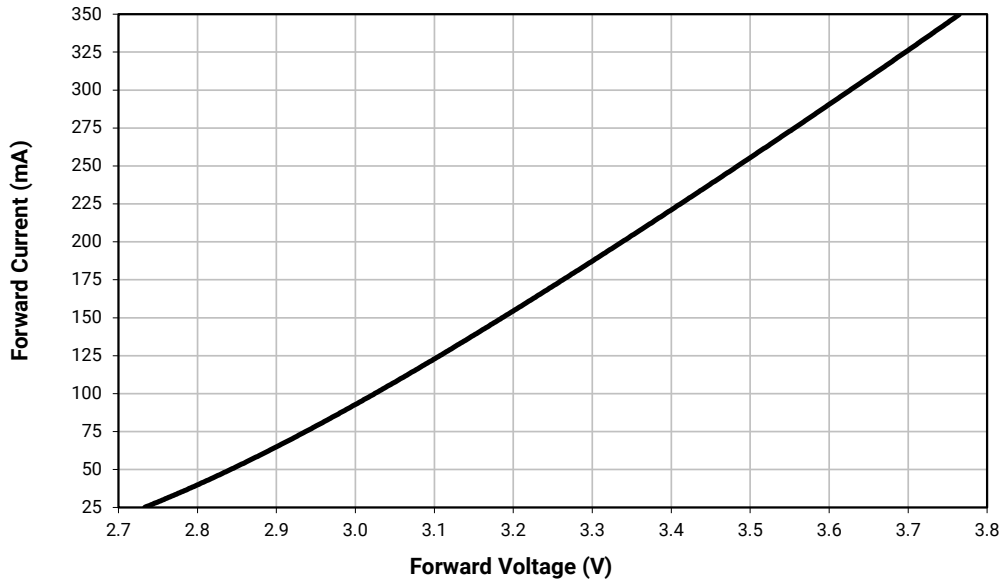

RELATIVE FLUX VS. CURRENT ($T_j = 25\text{ }^\circ\text{C}$)

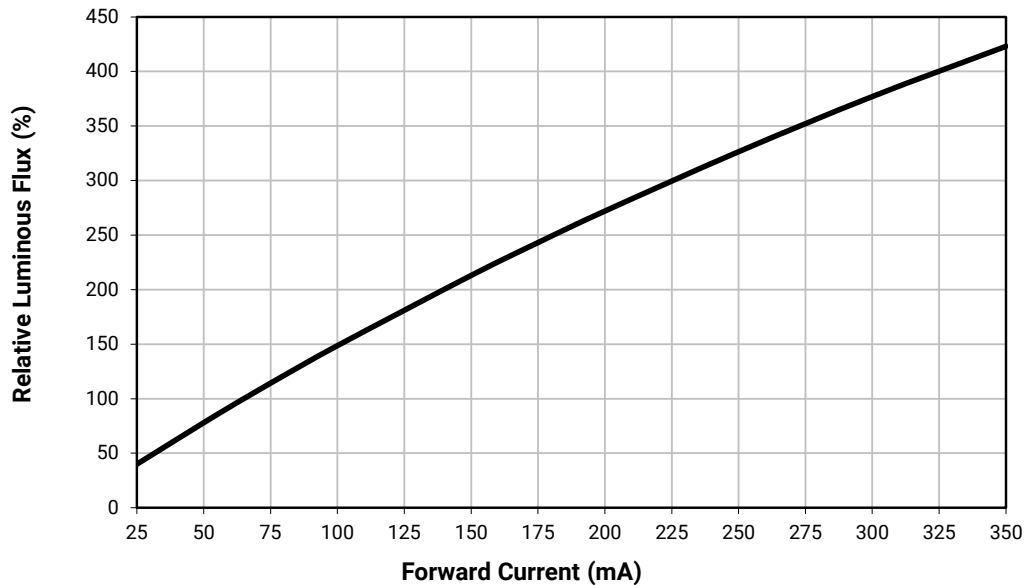

TYPICAL SPATIAL DISTRIBUTION

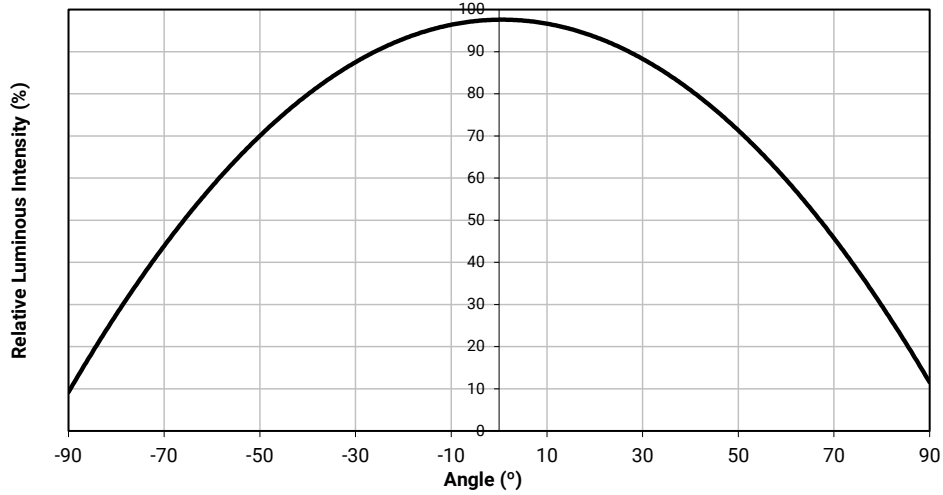

THERMAL DESIGN

The maximum forward current is determined by the thermal resistance between the LED junction and ambient. It is crucial for the end product to be designed in a manner that minimizes the thermal resistance from the solder point to ambient in order to optimize lamp life and optical characteristics.

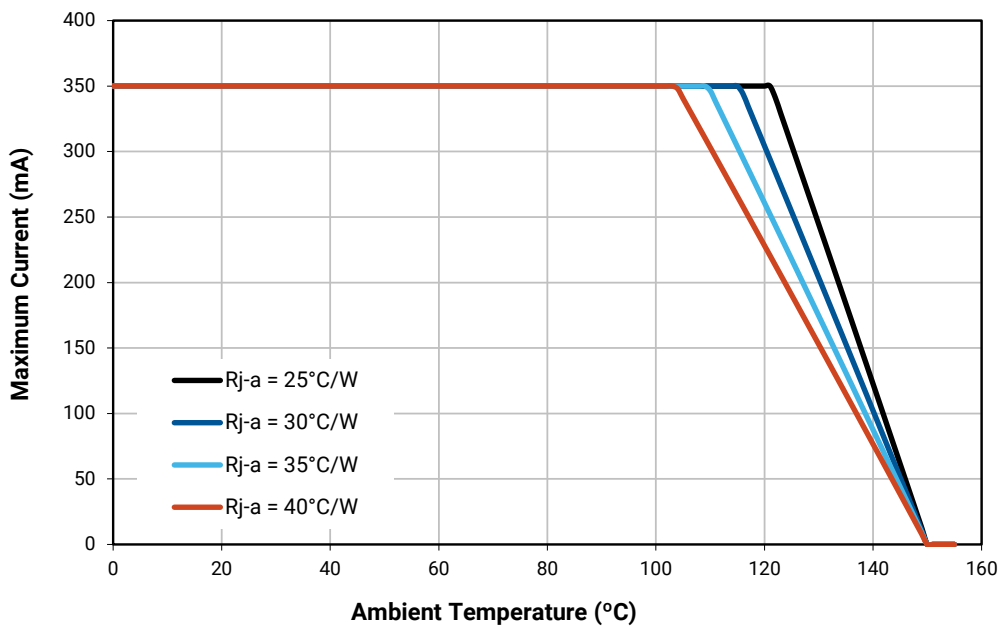

PERFORMANCE GROUPS – LUMINOUS FLUX (T_J = 25 °C)

XLamp XH-G LEDs are tested for luminous flux and placed into one of the following luminous-flux groups. These group codes, with a 0 appended, are used in the Bin Code “Luminous flux group.”

| Group Code | Minimum Luminous Flux (lm) | Maximum Luminous Flux (lm) |
|------------|----------------------------|----------------------------|
| H0 | 18.1 | 23.5 |
| J2 | 23.5 | 26.8 |
| J3 | 26.8 | 30.6 |
| K2 | 30.6 | 35.2 |
| K3 | 35.2 | 39.8 |

PERFORMANCE GROUPS – CHROMATICITY

XLamp XH-G LEDs are tested for chromaticity and placed into one of the following chromaticity groups. These group codes are used in the Bin Code “Chromaticity bin.” Two-digit group codes are appended with a 0.

| Region | x | y | Region | x | y | Region | x | y | Region | x | y |
|--------|--------|--------|--------|--------|--------|--------|--------|--------|--------|--------|--------|
| 0A | 0.2950 | 0.2970 | 0B | 0.2920 | 0.3060 | 0C | 0.2984 | 0.3133 | 0D | 0.2984 | 0.3133 |
| | 0.2920 | 0.3060 | | 0.2895 | 0.3135 | | 0.2962 | 0.3220 | | 0.3048 | 0.3207 |
| | 0.2984 | 0.3133 | | 0.2962 | 0.3220 | | 0.3028 | 0.3304 | | 0.3068 | 0.3113 |
| | 0.3009 | 0.3042 | | 0.2984 | 0.3133 | | 0.3048 | 0.3207 | | 0.3009 | 0.3042 |
| 0R | 0.2980 | 0.2880 | 0S | 0.2895 | 0.3135 | 0T | 0.2962 | 0.3220 | 0U | 0.3037 | 0.2937 |
| | 0.2950 | 0.2970 | | 0.2870 | 0.3210 | | 0.2937 | 0.3312 | | 0.3009 | 0.3042 |
| | 0.3009 | 0.3042 | | 0.2937 | 0.3312 | | 0.3005 | 0.3415 | | 0.3068 | 0.3113 |
| | 0.3037 | 0.2937 | | 0.2962 | 0.3220 | | 0.3028 | 0.3304 | | 0.3093 | 0.2993 |
| 1A | 0.3048 | 0.3207 | 1B | 0.3028 | 0.3304 | 1C | 0.3115 | 0.3391 | 1D | 0.3130 | 0.3290 |
| | 0.3130 | 0.3290 | | 0.3115 | 0.3391 | | 0.3205 | 0.3481 | | 0.3213 | 0.3373 |
| | 0.3144 | 0.3186 | | 0.3130 | 0.3290 | | 0.3213 | 0.3373 | | 0.3221 | 0.3261 |
| | 0.3068 | 0.3113 | | 0.3048 | 0.3207 | | 0.3130 | 0.3290 | | 0.3144 | 0.3186 |
| 1R | 0.3068 | 0.3113 | 1S | 0.3005 | 0.3415 | 1T | 0.3099 | 0.3509 | 1U | 0.3144 | 0.3186 |
| | 0.3144 | 0.3186 | | 0.3099 | 0.3509 | | 0.3196 | 0.3602 | | 0.3221 | 0.3261 |
| | 0.3161 | 0.3059 | | 0.3115 | 0.3391 | | 0.3205 | 0.3481 | | 0.3231 | 0.3120 |
| | 0.3093 | 0.2993 | | 0.3028 | 0.3304 | | 0.3115 | 0.3391 | | 0.3161 | 0.3059 |
| 2A | 0.3215 | 0.3350 | 2B | 0.3207 | 0.3462 | 2C | 0.3290 | 0.3538 | 2D | 0.3290 | 0.3417 |
| | 0.3290 | 0.3417 | | 0.3290 | 0.3538 | | 0.3376 | 0.3616 | | 0.3371 | 0.3490 |
| | 0.3290 | 0.3300 | | 0.3290 | 0.3417 | | 0.3371 | 0.3490 | | 0.3366 | 0.3369 |
| | 0.3222 | 0.3243 | | 0.3215 | 0.3350 | | 0.3290 | 0.3417 | | 0.3290 | 0.3300 |
| 2R | 0.3222 | 0.3243 | 2S | 0.3196 | 0.3602 | 2T | 0.3290 | 0.3690 | 2U | 0.3290 | 0.3300 |
| | 0.3290 | 0.3300 | | 0.3290 | 0.3690 | | 0.3381 | 0.3762 | | 0.3366 | 0.3369 |
| | 0.3290 | 0.3180 | | 0.3290 | 0.3538 | | 0.3376 | 0.3616 | | 0.3361 | 0.3245 |
| | 0.3231 | 0.3120 | | 0.3207 | 0.3462 | | 0.3290 | 0.3538 | | 0.3290 | 0.3180 |

PERFORMANCE GROUPS – CHROMATICITY (CONTINUED)

| Region | x | y | Region | x | y | Region | x | y | Region | x | y |
|--------|--------|--------|--------|--------|--------|--------|--------|--------|--------|--------|--------|
| 3A | 0.3371 | 0.3490 | 3B | 0.3376 | 0.3616 | 3C | 0.3463 | 0.3687 | 3D | 0.3451 | 0.3554 |
| | 0.3451 | 0.3554 | | 0.3463 | 0.3687 | | 0.3551 | 0.3760 | | 0.3533 | 0.3620 |
| | 0.3440 | 0.3427 | | 0.3451 | 0.3554 | | 0.3533 | 0.3620 | | 0.3515 | 0.3487 |
| | 0.3366 | 0.3369 | | 0.3371 | 0.3490 | | 0.3451 | 0.3554 | | 0.3440 | 0.3427 |
| 3R | 0.3366 | 0.3369 | 3S | 0.3381 | 0.3762 | | | | | | |
| | 0.3440 | 0.3428 | | 0.3480 | 0.3840 | | | | | | |
| | 0.3429 | 0.3307 | | 0.3463 | 0.3687 | | | | | | |
| | 0.3361 | 0.3245 | | 0.3376 | 0.3616 | | | | | | |
| 4A | 0.3530 | 0.3597 | 4B | 0.3548 | 0.3736 | 4C | 0.3641 | 0.3804 | 4D | 0.3615 | 0.3659 |
| | 0.3615 | 0.3659 | | 0.3641 | 0.3804 | | 0.3736 | 0.3874 | | 0.3702 | 0.3722 |
| | 0.3590 | 0.3521 | | 0.3615 | 0.3659 | | 0.3702 | 0.3722 | | 0.3670 | 0.3578 |
| | 0.3512 | 0.3465 | | 0.3530 | 0.3597 | | 0.3615 | 0.3659 | | 0.3590 | 0.3521 |
| 5A1 | 0.3670 | 0.3578 | 5A2 | 0.3686 | 0.3649 | 5A3 | 0.3744 | 0.3685 | 5A4 | 0.3726 | 0.3612 |
| | 0.3686 | 0.3649 | | 0.3702 | 0.3722 | | 0.3763 | 0.3760 | | 0.3744 | 0.3685 |
| | 0.3744 | 0.3685 | | 0.3763 | 0.3760 | | 0.3825 | 0.3798 | | 0.3804 | 0.3721 |
| | 0.3726 | 0.3612 | | 0.3744 | 0.3685 | | 0.3804 | 0.3721 | | 0.3783 | 0.3646 |
| 5B1 | 0.3702 | 0.3722 | 5B2 | 0.3719 | 0.3797 | 5B3 | 0.3782 | 0.3837 | 5B4 | 0.3763 | 0.3760 |
| | 0.3719 | 0.3797 | | 0.3736 | 0.3874 | | 0.3802 | 0.3916 | | 0.3782 | 0.3837 |
| | 0.3782 | 0.3837 | | 0.3802 | 0.3916 | | 0.3869 | 0.3958 | | 0.3847 | 0.3877 |
| | 0.3763 | 0.3760 | | 0.3782 | 0.3837 | | 0.3847 | 0.3877 | | 0.3825 | 0.3798 |
| 5C1 | 0.3825 | 0.3798 | 5C2 | 0.3847 | 0.3877 | 5C3 | 0.3912 | 0.3917 | 5C4 | 0.3887 | 0.3836 |
| | 0.3847 | 0.3877 | | 0.3869 | 0.3958 | | 0.3937 | 0.4001 | | 0.3912 | 0.3917 |
| | 0.3912 | 0.3917 | | 0.3937 | 0.4001 | | 0.4006 | 0.4044 | | 0.3978 | 0.3958 |
| | 0.3887 | 0.3836 | | 0.3912 | 0.3917 | | 0.3978 | 0.3958 | | 0.3950 | 0.3875 |
| 5D1 | 0.3783 | 0.3646 | 5D2 | 0.3804 | 0.3721 | 5D3 | 0.3863 | 0.3758 | 5D4 | 0.3840 | 0.3681 |
| | 0.3804 | 0.3721 | | 0.3825 | 0.3798 | | 0.3887 | 0.3836 | | 0.3863 | 0.3758 |
| | 0.3863 | 0.3758 | | 0.3887 | 0.3836 | | 0.3950 | 0.3875 | | 0.3924 | 0.3794 |
| | 0.3840 | 0.3681 | | 0.3863 | 0.3758 | | 0.3924 | 0.3794 | | 0.3898 | 0.3716 |
| 6A1 | 0.3889 | 0.3690 | 6A2 | 0.3915 | 0.3768 | 6A3 | 0.3981 | 0.3800 | 6A4 | 0.3953 | 0.3720 |
| | 0.3915 | 0.3768 | | 0.3941 | 0.3848 | | 0.4010 | 0.3882 | | 0.3981 | 0.3800 |
| | 0.3981 | 0.3800 | | 0.4010 | 0.3882 | | 0.4080 | 0.3916 | | 0.4048 | 0.3832 |
| | 0.3953 | 0.3720 | | 0.3981 | 0.3800 | | 0.4048 | 0.3832 | | 0.4017 | 0.3751 |
| 6B1 | 0.3941 | 0.3848 | 6B2 | 0.3968 | 0.3930 | 6B3 | 0.4040 | 0.3966 | 6B4 | 0.4010 | 0.3882 |
| | 0.3968 | 0.3930 | | 0.3996 | 0.4015 | | 0.4071 | 0.4052 | | 0.4040 | 0.3966 |
| | 0.4040 | 0.3966 | | 0.4071 | 0.4052 | | 0.4146 | 0.4089 | | 0.4113 | 0.4001 |
| | 0.4010 | 0.3882 | | 0.4040 | 0.3966 | | 0.4113 | 0.4001 | | 0.4080 | 0.3916 |
| 6C1 | 0.4080 | 0.3916 | 6C2 | 0.4113 | 0.4001 | 6C3 | 0.4186 | 0.4037 | 6C4 | 0.4150 | 0.3950 |
| | 0.4113 | 0.4001 | | 0.4146 | 0.4089 | | 0.4222 | 0.4127 | | 0.4186 | 0.4037 |
| | 0.4186 | 0.4037 | | 0.4222 | 0.4127 | | 0.4299 | 0.4165 | | 0.4259 | 0.4073 |
| | 0.4150 | 0.3950 | | 0.4186 | 0.4037 | | 0.4259 | 0.4073 | | 0.4221 | 0.3984 |

PERFORMANCE GROUPS – CHROMATICITY (CONTINUED)

| Region | x | y | Region | x | y | Region | x | y | Region | x | y |
|--------|--------|--------|--------|--------|--------|--------|--------|--------|--------|--------|--------|
| 6D1 | 0.4017 | 0.3751 | 6D2 | 0.4048 | 0.3832 | 6D3 | 0.4116 | 0.3865 | 6D4 | 0.4082 | 0.3782 |
| | 0.4048 | 0.3832 | | 0.4080 | 0.3916 | | 0.4150 | 0.3950 | | 0.4116 | 0.3865 |
| | 0.4116 | 0.3865 | | 0.4150 | 0.3950 | | 0.4221 | 0.3984 | | 0.4183 | 0.3898 |
| | 0.4082 | 0.3782 | | 0.4116 | 0.3865 | | 0.4183 | 0.3898 | | 0.4147 | 0.3814 |
| 7A1 | 0.4147 | 0.3814 | 7A2 | 0.4183 | 0.3898 | 7A3 | 0.4242 | 0.3919 | 7A4 | 0.4203 | 0.3833 |
| | 0.4183 | 0.3898 | | 0.4221 | 0.3984 | | 0.4281 | 0.4006 | | 0.4242 | 0.3919 |
| | 0.4242 | 0.3919 | | 0.4281 | 0.4006 | | 0.4342 | 0.4028 | | 0.4300 | 0.3939 |
| | 0.4203 | 0.3833 | | 0.4242 | 0.3919 | | 0.4300 | 0.3939 | | 0.4259 | 0.3853 |
| 7B1 | 0.4221 | 0.3984 | 7B2 | 0.4259 | 0.4073 | 7B3 | 0.4322 | 0.4096 | 7B4 | 0.4281 | 0.4006 |
| | 0.4259 | 0.4073 | | 0.4299 | 0.4165 | | 0.4364 | 0.4188 | | 0.4322 | 0.4096 |
| | 0.4322 | 0.4096 | | 0.4364 | 0.4188 | | 0.4430 | 0.4212 | | 0.4385 | 0.4119 |
| | 0.4281 | 0.4006 | | 0.4322 | 0.4096 | | 0.4385 | 0.4119 | | 0.4342 | 0.4028 |
| 7C1 | 0.4342 | 0.4028 | 7C2 | 0.4385 | 0.4119 | 7C3 | 0.4449 | 0.4141 | 7C4 | 0.4403 | 0.4049 |
| | 0.4385 | 0.4119 | | 0.4430 | 0.4212 | | 0.4496 | 0.4236 | | 0.4449 | 0.4141 |
| | 0.4449 | 0.4141 | | 0.4496 | 0.4236 | | 0.4562 | 0.4260 | | 0.4513 | 0.4164 |
| | 0.4403 | 0.4049 | | 0.4449 | 0.4141 | | 0.4513 | 0.4164 | | 0.4465 | 0.4071 |
| 7D1 | 0.4259 | 0.3853 | 7D2 | 0.4300 | 0.3939 | 7D3 | 0.4359 | 0.3960 | 7D4 | 0.4316 | 0.3873 |
| | 0.4300 | 0.3939 | | 0.4342 | 0.4028 | | 0.4403 | 0.4049 | | 0.4359 | 0.3960 |
| | 0.4359 | 0.3960 | | 0.4403 | 0.4049 | | 0.4465 | 0.4071 | | 0.4418 | 0.3981 |
| | 0.4316 | 0.3873 | | 0.4359 | 0.3960 | | 0.4418 | 0.3981 | | 0.4373 | 0.3893 |
| 8A1 | 0.4373 | 0.3893 | 8A2 | 0.4418 | 0.3981 | 8A3 | 0.4475 | 0.3994 | 8A4 | 0.4428 | 0.3906 |
| | 0.4418 | 0.3981 | | 0.4465 | 0.4071 | | 0.4523 | 0.4085 | | 0.4475 | 0.3994 |
| | 0.4475 | 0.3994 | | 0.4523 | 0.4085 | | 0.4582 | 0.4099 | | 0.4532 | 0.4008 |
| | 0.4428 | 0.3906 | | 0.4475 | 0.3994 | | 0.4532 | 0.4008 | | 0.4483 | 0.3919 |
| 8B1 | 0.4465 | 0.4071 | 8B2 | 0.4513 | 0.4164 | 8B3 | 0.4573 | 0.4178 | 8B4 | 0.4523 | 0.4085 |
| | 0.4513 | 0.4164 | | 0.4562 | 0.4260 | | 0.4624 | 0.4274 | | 0.4573 | 0.4178 |
| | 0.4573 | 0.4178 | | 0.4624 | 0.4274 | | 0.4687 | 0.4289 | | 0.4634 | 0.4193 |
| | 0.4523 | 0.4085 | | 0.4573 | 0.4178 | | 0.4634 | 0.4193 | | 0.4582 | 0.4099 |
| 8C1 | 0.4582 | 0.4099 | 8C2 | 0.4634 | 0.4193 | 8C3 | 0.4695 | 0.4207 | 8C4 | 0.4641 | 0.4112 |
| | 0.4634 | 0.4193 | | 0.4687 | 0.4289 | | 0.4750 | 0.4304 | | 0.4695 | 0.4207 |
| | 0.4695 | 0.4207 | | 0.4750 | 0.4304 | | 0.4813 | 0.4319 | | 0.4756 | 0.4221 |
| | 0.4641 | 0.4112 | | 0.4695 | 0.4207 | | 0.4756 | 0.4221 | | 0.4700 | 0.4126 |
| 8D1 | 0.4483 | 0.3919 | 8D2 | 0.4532 | 0.4008 | 8D3 | 0.4589 | 0.4021 | 8D4 | 0.4538 | 0.3931 |
| | 0.4532 | 0.4008 | | 0.4582 | 0.4099 | | 0.4641 | 0.4112 | | 0.4589 | 0.4021 |
| | 0.4589 | 0.4021 | | 0.4641 | 0.4112 | | 0.4700 | 0.4126 | | 0.4646 | 0.4034 |
| | 0.4538 | 0.3931 | | 0.4589 | 0.4021 | | 0.4646 | 0.4034 | | 0.4593 | 0.3944 |

STANDARD COOL WHITE KITS PLOTTED ON ANSI STANDARD CHROMATICITY REGIONS

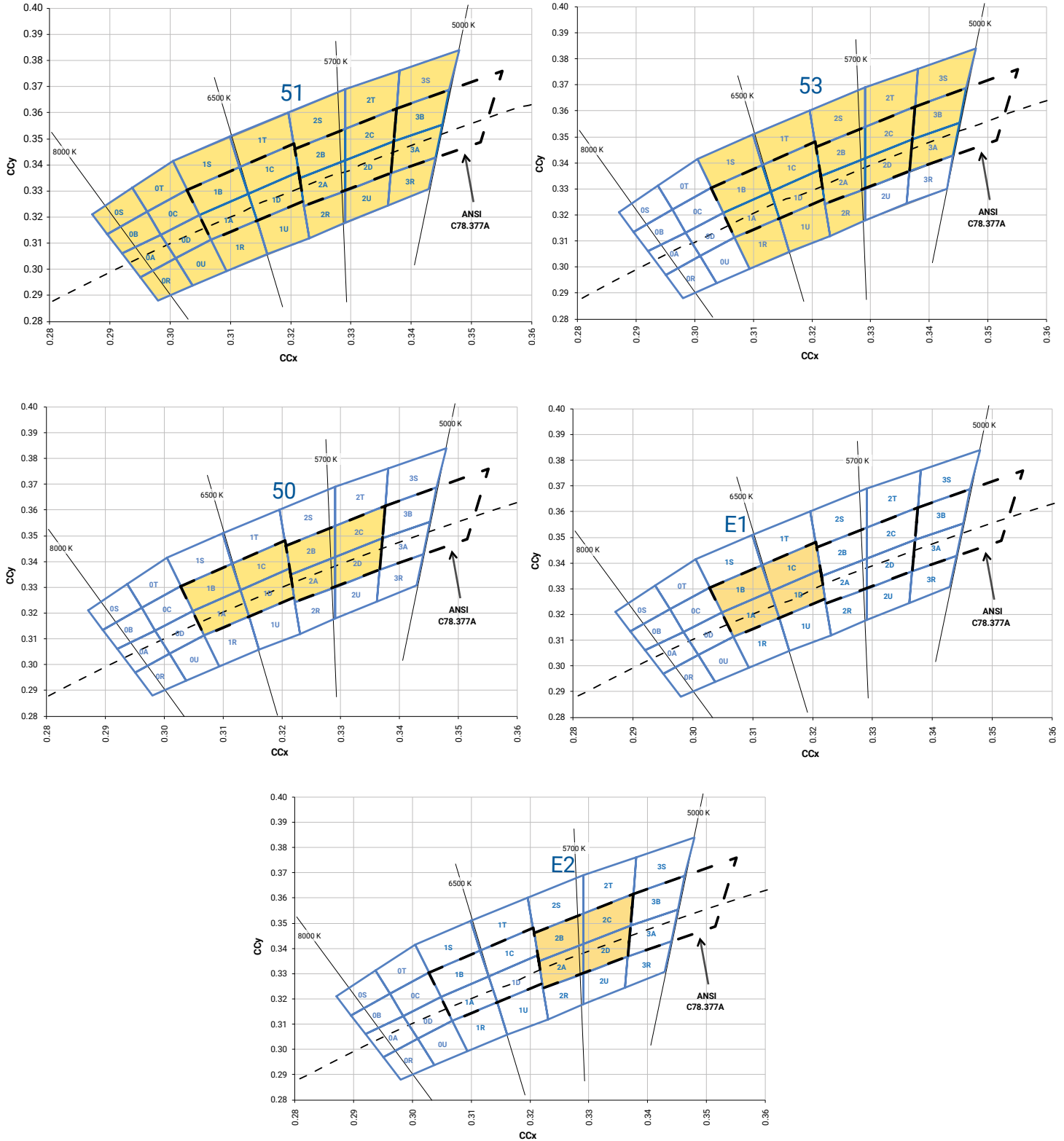

STANDARD WARM AND NEUTRAL WHITE KITS PLOTTED ON ANSI STANDARD CHROMATICITY REGIONS

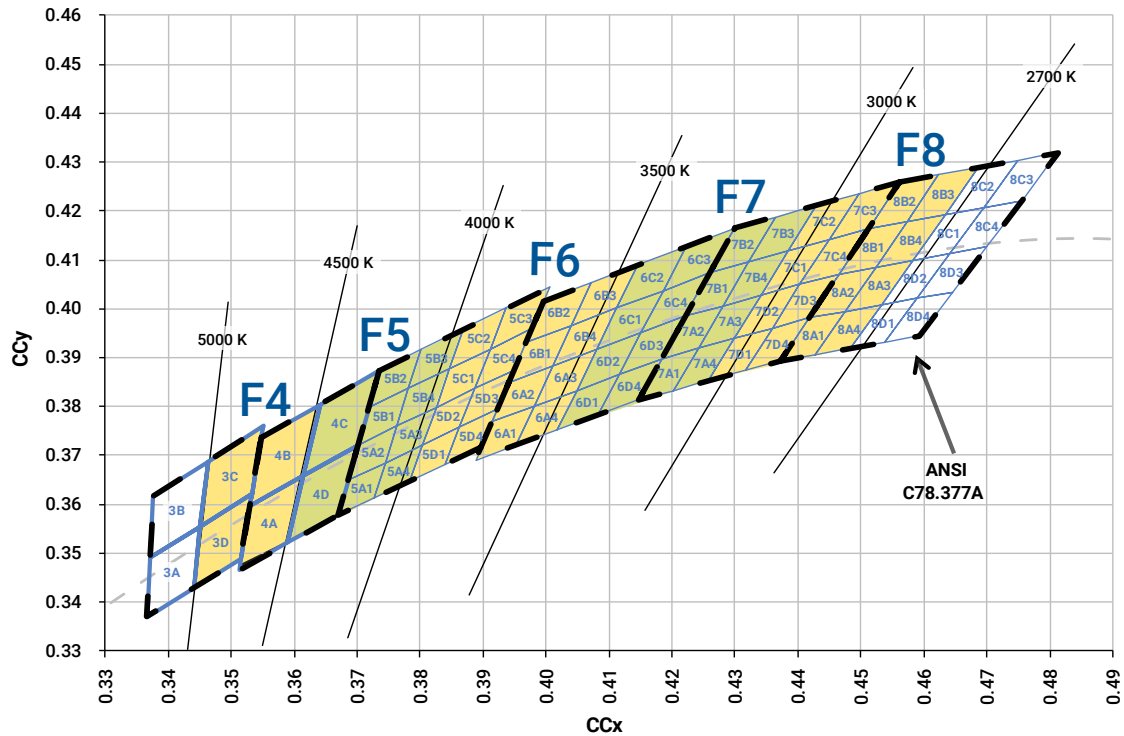
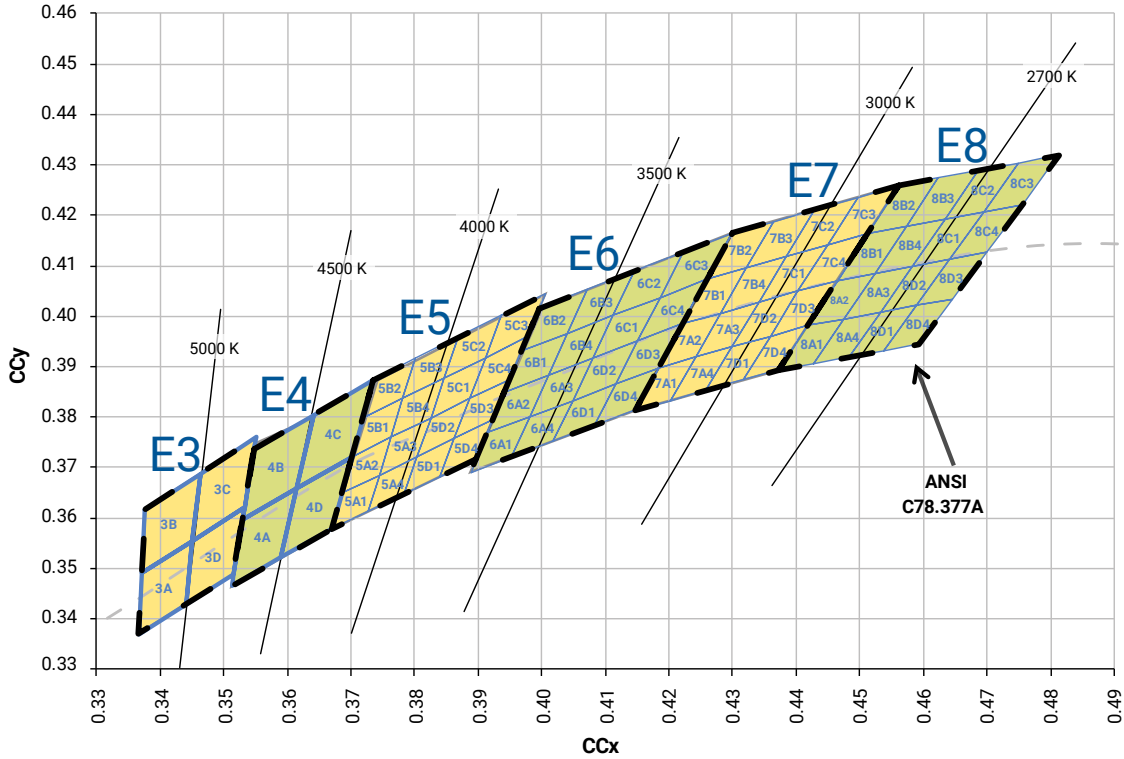

STANDARD CHROMATICITY KITS

The following table provides the chromaticity bins associated with chromaticity kits.

| Color | CCT | Kit | Chromaticity Bins |
|---------------|--------|-----|--|
| Cool White | 6200 K | 51 | 0A, 0B, 0C, 0D, 0R, 0S, 0T, 0U, 1A, 1B, 1C, 1D, 1R, 1S, 1T, 1U, 2A, 2B, 2C, 2D, 2R, 2S, 2T, 2U, 3A, 3B, 3R, 3S |
| | 6000 K | 53 | 1A, 1B, 1C, 1D, 1R, 1S, 1T, 1U, 2A, 2B, 2C, 2D, 2R, 2S, 2T, 3A, 3B, 3S |
| | 6200 K | 50 | 1A, 1B, 1C, 1D, 2A, 2B, 2C, 2D |
| | 6500 K | E1 | 1A, 1B, 1C, 1D |
| | 5700 K | E2 | 2A, 2B, 2C, 2D |
| Neutral White | 5000 K | E3 | 3A, 3B, 3C, 3D |
| | 4750 K | F4 | 3C, 3D, 4A, 4B |
| | 4500 K | E4 | 4A, 4B, 4C, 4D |
| | 4250 K | F5 | 4C, 4D, 5A1, 5A2, 5A3, 5A4, 5B1, 5B2, 5B3, 5B4 |
| | 4000 K | E5 | 5A1, 5A2, 5A3, 5A4, 5B1, 5B2, 5B3, 5B4, 5C1, 5C2, 5C3, 5C4, 5D1, 5D2, 5D3, 5D4 |
| Warm White | 3750 K | F6 | 5C1, 5C2, 5C3, 5C4, 5D1, 5D2, 5D3, 5D4, 6A1, 6A2, 6A3, 6A4, 6B1, 6B2, 6B3, 6B4 |
| | 3500 K | E6 | 6A1, 6A2, 6A3, 6A4, 6B1, 6B2, 6B3, 6B4, 6C1, 6C2, 6C3, 6C4, 6D1, 6D2, 6D3, 6D4 |
| | 3250 K | F7 | 6C1, 6C2, 6C3, 6C4, 6D1, 6D2, 6D3, 6D4, 7A1, 7A2, 7A3, 7A4, 7B1, 7B2, 7B3, 7B4 |
| | 3000 K | E7 | 7A1, 7A2, 7A3, 7A4, 7B1, 7B2, 7B3, 7B4, 7C1, 7C2, 7C3, 7C4, 7D1, 7D2, 7D3, 7D4 |
| | 2850 K | F8 | 7C1, 7C2, 7C3, 7C4, 7D1, 7D2, 7D3, 7D4, 8A1, 8A2, 8A3, 8A4, 8B1, 8B2, 8B3, 8B4 |
| | 2700 K | E8 | 8A1, 8A2, 8A3, 8A4, 8B1, 8B2, 8B3, 8B4, 8C1, 8C2, 8C3, 8C4, 8D1, 8D2, 8D3, 8D4 |

BIN AND ORDER CODE FORMAT

Bin codes and order codes for XH-G LEDs are configured in the following manner:

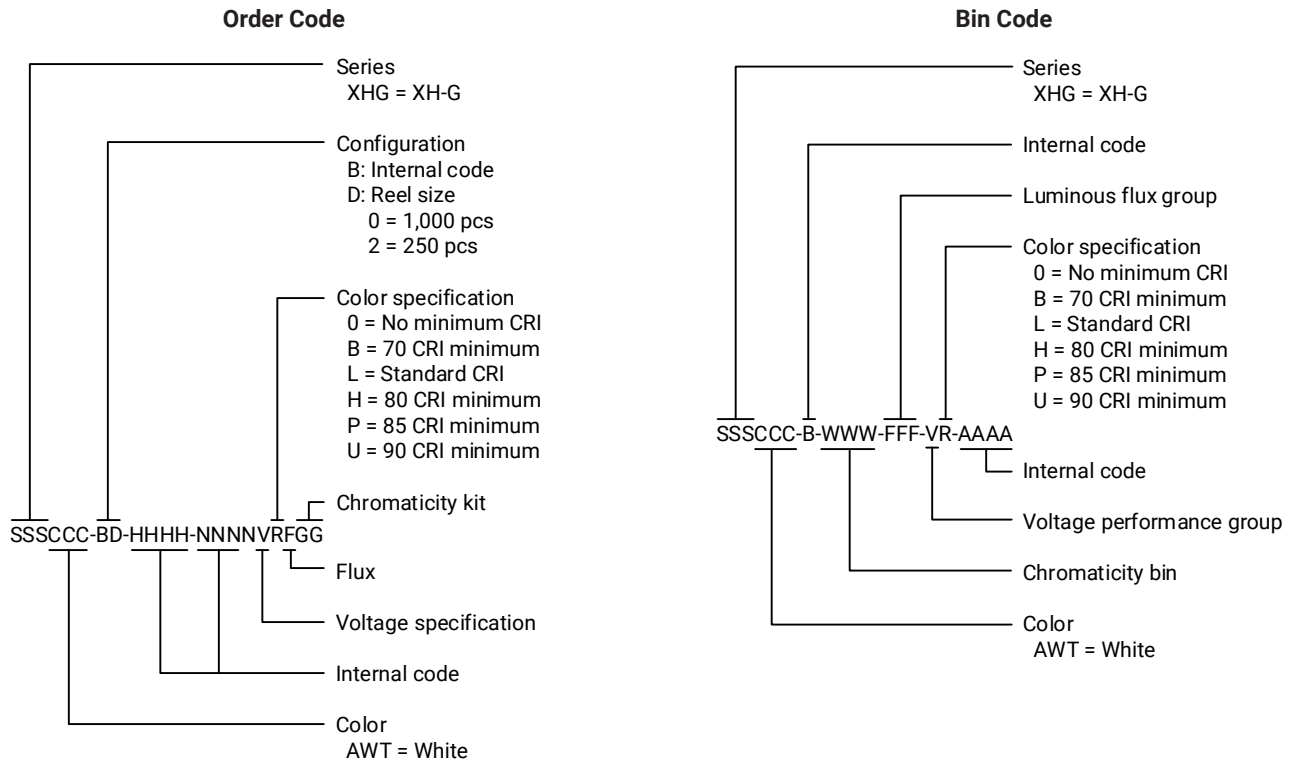

REFLOW SOLDERING CHARACTERISTICS

In testing, Cree LED has found XLamp XH-G LEDs to be compatible with JEDEC J-STD-020C, using the parameters listed below. As a general guideline, Cree LED recommends that users follow the recommended soldering profile provided by the manufacturer of the solder paste used, and therefore it is the lamp or luminaire manufacturer’s responsibility to determine applicable soldering requirements.

Note that this general guideline may not apply to all PCB designs and configurations of reflow soldering equipment.

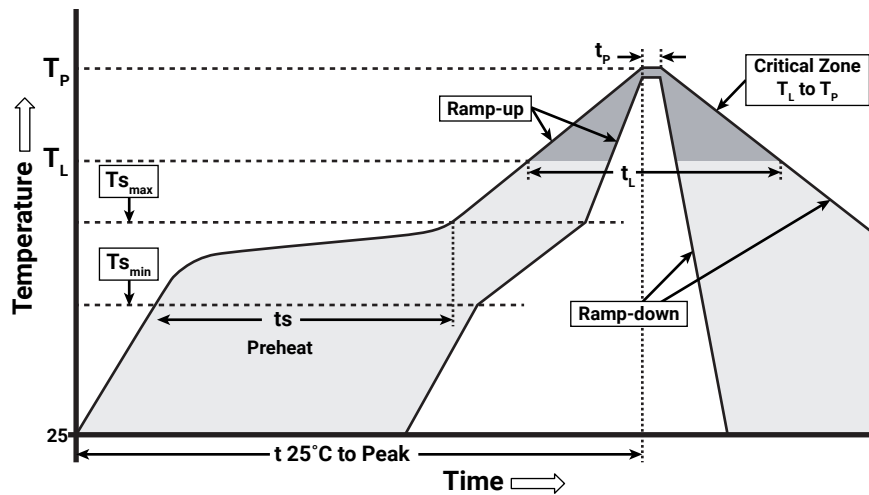

IPC/JEDEC J-STD-020C

| Profile Feature | Lead-Free Solder |
|---|------------------|
| Average Ramp-Up Rate ($T_{S_{max}}$ to T_P) | 1.2 °C/second |
| Preheat: Temperature Min ($T_{S_{min}}$) | 120 °C |
| Preheat: Temperature Max ($T_{S_{max}}$) | 170 °C |
| Preheat: Time ($t_{S_{min}}$ to $t_{S_{max}}$) | 65-150 seconds |
| Time Maintained Above: Temperature (T_L) | 217 °C |
| Time Maintained Above: Time (t_L) | 45-90 seconds |
| Peak/Classification Temperature (T_P) | 235 - 245 °C |
| Time Within 5 °C of Actual Peak Temperature (t_P) | 20-40 seconds |
| Ramp-Down Rate | 1 - 6 °C/second |
| Time 25 °C to Peak Temperature | 4 minutes max. |

Note: All temperatures refer to topside of the package, measured on the package body surface.

NOTES

Measurements

The luminous flux, radiant power, chromaticity, forward voltage and CRI measurements in this document are binning specifications only and solely represent product measurements as of the date of shipment. These measurements will change over time based on a number of factors that are not within Cree LED's control and are not intended or provided as operational specifications for the products. Calculated values are provided for informational purposes only and are not intended or provided as specifications.

Pre-Release Qualification Testing

Please read the [LED Reliability Overview](#) for details of the qualification process Cree LED applies to ensure long-term reliability for XLamp LEDs and details of Cree LED's pre-release qualification testing for XLamp LEDs.

Lumen Maintenance

Cree LED now uses standardized IES LM-80-08 and TM-21-11 methods for collecting long-term data and extrapolating LED lumen maintenance. For information on the specific LM-80 data sets available for this LED, refer to the public [LM-80 results document](#).

Please read the [Long-Term Lumen Maintenance application note](#) for more details on Cree LED's lumen maintenance testing and forecasting. Please read the [Thermal Management application note](#) for details on how thermal design, ambient temperature, and drive current affect the LED junction temperature.

Moisture Sensitivity

Cree LED recommends keeping XLamp LEDs in the provided, resealable moisture-barrier packaging (MBP) until immediately prior to soldering. Unopened MBPs that contain XLamp LEDs do not need special storage for moisture sensitivity.

Once the MBP is opened, XLamp XH-G LEDs may be stored as MSL 1 per JEDEC J-STD-033, meaning they have unlimited floor life in conditions of ≤ 30 °C/85% relative humidity (RH). Regardless of storage condition, Cree LED recommends sealing any unsoldered LEDs in the original MBP.

RoHS Compliance

The levels of RoHS restricted materials in this product are below the maximum concentration values (also referred to as the threshold limits) permitted for such substances, or are used in an exempted application, in accordance with EU Directive 2011/65/EC (RoHS2), as implemented January 2, 2013. RoHS Declarations for this product can be obtained from your Cree LED representative or from the [Product Ecology](#) section of the Cree LED website.

REACH Compliance

REACH substances of very high concern (SVHCs) information is available for this product. Since the European Chemical Agency (ECHA) has published notice of their intent to frequently revise the SVHC listing for the foreseeable future, please contact a Cree LED representative to insure you get the most up-to-date REACH SVHC Declaration. REACH banned substance information (REACH Article 67) is also available upon request.

NOTES - CONTINUED

UL® Recognized Component

This product meets the requirements to be considered a UL Recognized Component with Level 4 enclosure consideration. The LED package or a portion thereof has been investigated as a fire and electrical enclosure per ANSI/UL 8750.

Vision Advisory

WARNING: Do not look at an exposed lamp in operation. Eye injury can result. For more information about LEDs and eye safety, please refer to the [LED Eye Safety application note](#).

MECHANICAL DIMENSIONS

All dimensions are ± 0.13 mm unless otherwise indicated.

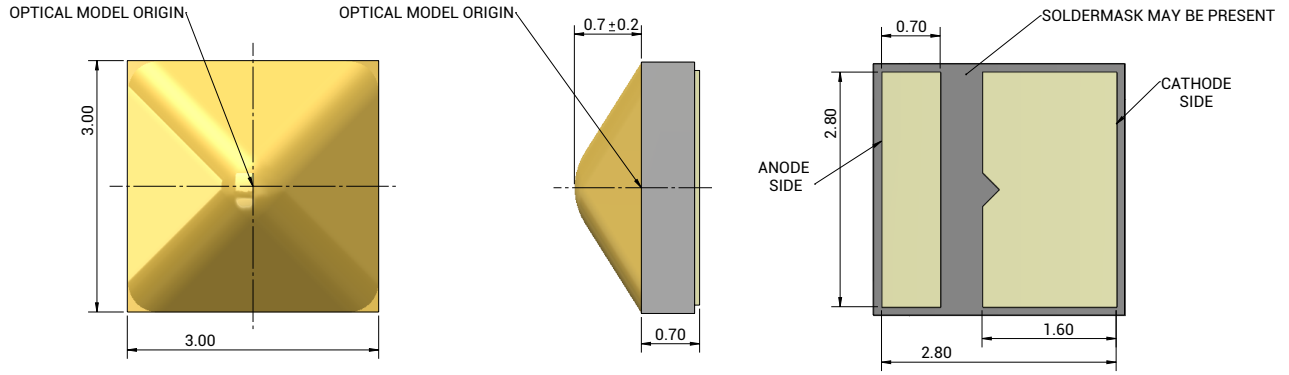

Top View

Side View

Bottom View

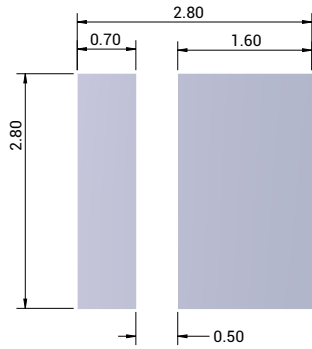

Recommended PCB Footprint

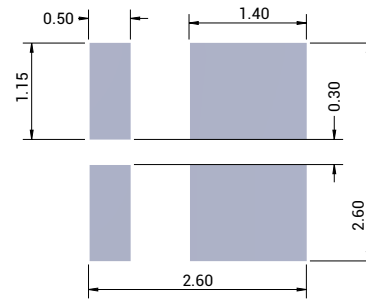

Recommended Stencil Opening

TAPE AND REEL

All Cree LED carrier tapes conform to EIA-481D, Automated Component Handling Systems Standard.

All dimensions are ± 0.13 mm unless otherwise indicated.

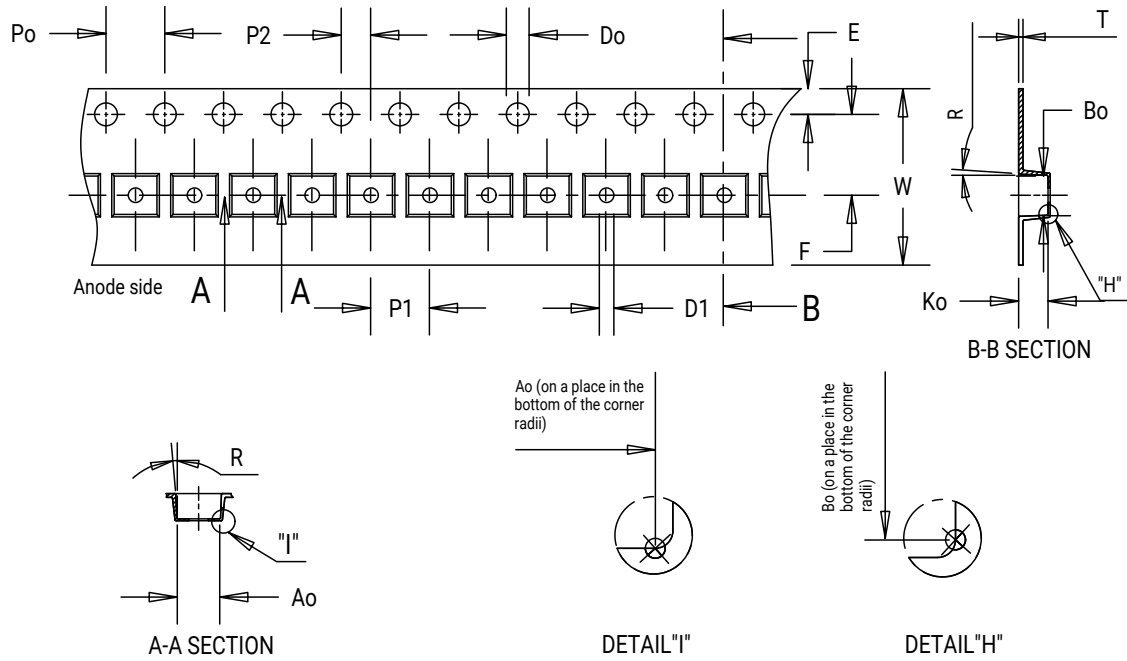

| Item | Ao | Bo | Ko | Po | P1 | P2 | T | E | F | Do | D1 | W | R |
|------|------|------|------|------|------|------|------|------|------|------|------|-------|----|
| Dim. | 3.30 | 3.30 | 1.55 | 4.00 | 8.00 | 2.00 | 0.30 | 1.75 | 5.50 | 1.50 | 1.50 | 12.00 | 3° |

TAPE AND REEL - CONTINUED

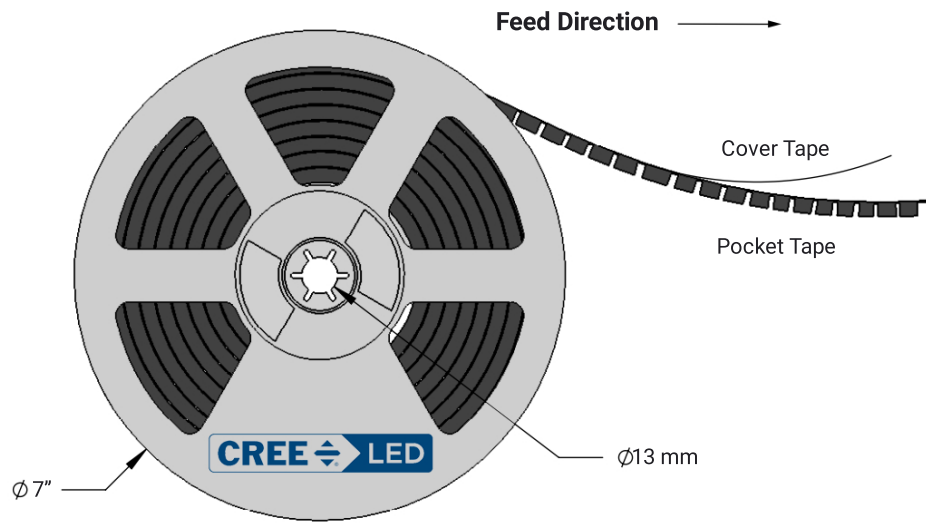
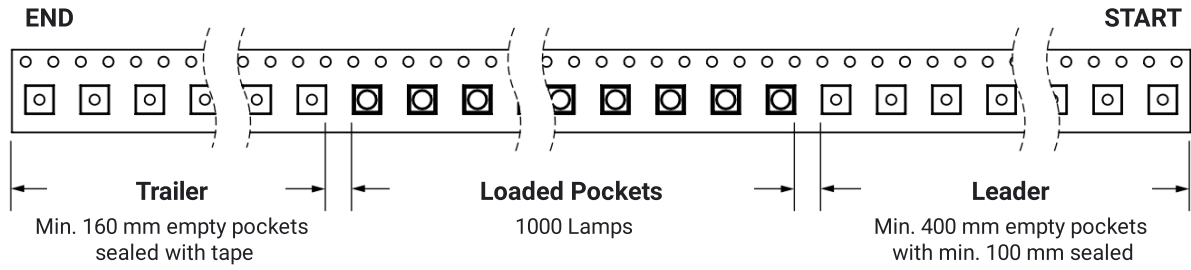

PACKAGING

The diagrams below show the packaging and labels Cree LED uses to ship XLamp XH-G LEDs. XLamp XH-G LEDs are shipped in tape loaded on a reel. Each box contains only one reel in a moisture barrier bag.

Unpackaged Reel

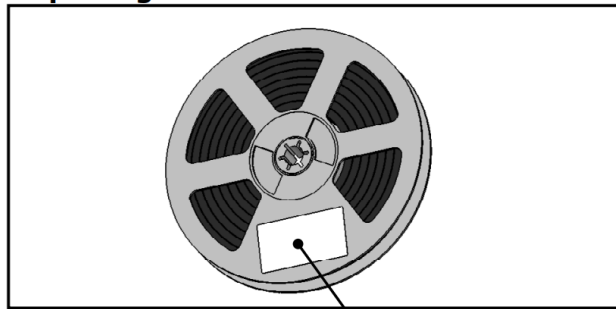

Label with Cree LED Bin Code, Quantity, Reel ID

Packaged Reel

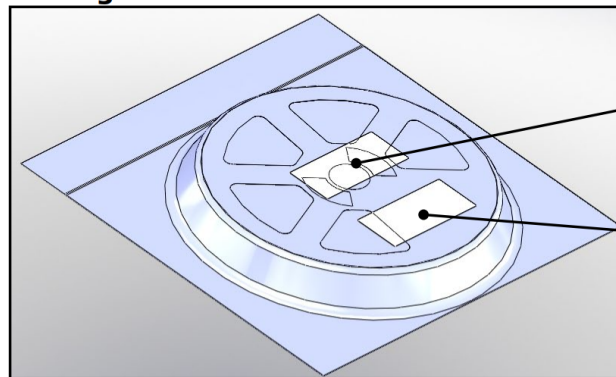

Label with Cree LED Order Code, Quantity, Reel ID, PO#

Label with Cree LED Bin Code, Quantity, Reel ID

Boxed Reel

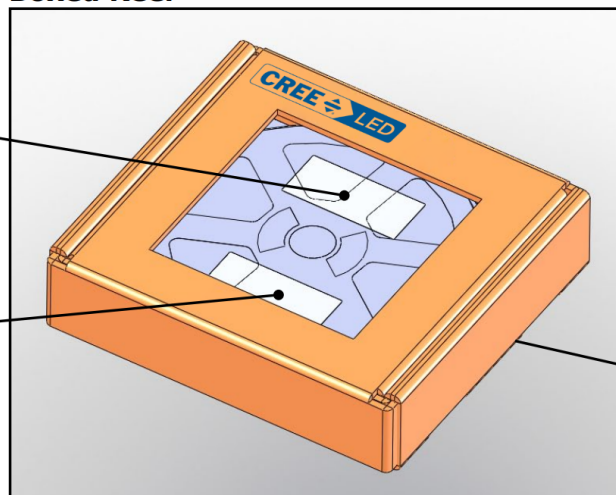

Label with Cree LED Order Code, Quantity, Reel ID, PO#

Label with Cree LED Bin Code, Quantity, Reel ID

Patent Label (on bottom of box)