

WCDMA 3G GPS Tracker

For Vehicle

User Manual

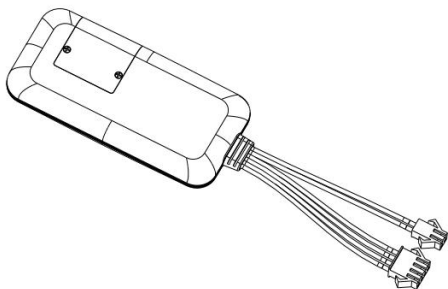

MODEL: TK119-W

WCDMA 3G Vehicle GPS Tracker

I. Product Features.....	16
II. Components and Accessories...	18
III. SIM card Installation.....	19
IV. Terminal Installation.....	22
4.1 Install the terminal.....	22
4.2 Terminal wiring definition....	24
4.3 Relay wiring.....	26
V. Power On / Off.....	27
5.1 Power on.....	27
5.2 LED Indicators.....	27
5.3 Power off.....	29
VI. Inquiry/Monitoring/Cut Oil.....	29
6.1 Inquiry by service platform..	29
6.2 Inquiry by SMS.....	29
6.3 Cut Oil /Restore.....	30
VII. Terminal Alarm.....	30
7.1 Vibration Alarm.....	30
7.2 Collision / falling Alarm.....	31
7.3 Speed Alarm.....	31
7.4 Shift Alarm.....	31

7.5 Geo-fence Alarm.....	31
7.6 Power disconnect Alarm.....	31
7.7 Low battery Alarm.....	31
VIII. Terminal Setting.....	32
IX. Trouble shooting.....	32
9.1 Cannot connect platform.....	32
9.2 Offline status.....	33
9.3 No positioned.....	34
9.4 Position drift.....	35
9.5 Commands receiving abnormally.....	35
X. Warranty rules.....	35
10.1 Special statement.....	35
10.2 Warranty period.....	36
10.3 After sales.....	36
Warranty Card/保修卡.....	37

Welcome to use our terminal , please read this manual carefully to install and operate the terminal exactly. This user manual is for reference only. If some contents and operation steps are inconsistent with those for the actual product, the latter will prevail.

Using TK119-W 3G GPS tracker, we can position, monitor and control the vehicle on the position server via GPS,WCDMA,GPRS and Internet. It can help customers to manage transparently, reduce cost, maintain security and raise efficiency. Now it is widely used in business traffic, logistics distribution, automobile lease, intelligent transportation, shipping market, army and police, rescuing, Safety Supervision and Intelligent city...

I. Product Features

- Supports WCDMA triple band ,GSM quad bands , universal in the world.
- Input Voltage: 7-36V DC.
- Located by GPS / LBS, support A-GPS
- GPS data uploaded by WCDMA/GPRS regularly, Web browser platform, Smart phone app and SMS query.
- ACC and vehicle status detection.
- Built-in battery, Power disconnect alarm & Low battery alarm.
- Built-in G-sensor ,Vibration, collision and falling alarm.
- GEO-fence alarm, speed & shift alarm.
- Remotely cut oil by Relay.
- Extend I/O port for extensional functions
- Multiple protocol support, OTA upgrade program.
- Water proof level IP67

Basic Specifications

Voltage	12 / 24 / 36 VDC
Work Current	<50mA@12V
Standby Current	<10mA@12V
GPS Accuracy	5-15m
LBS Accuracy	About 200m
GPS Frequency	1575MHz
GSM Frequency	850 / 900 / 1800 / 1900 MHz
WCDMA Frequency	W850 / W1900/ W2100 MHz
Hot/warm/cold Start	<3s, <15s, <60s
Battery Capacity	70mAh
Dimensions (mm)	87(L)X41.6(W)X 12(H)
Work Temperature	-20°C~70°C
Work Humidity	20%~80%RH
Net Weight	50 g

II. Components and Accessories

■ 2.1 Components

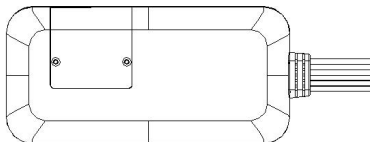

-Top Front-



-Bottom -

■ Accessories (reference pictures)



Power Cables (Fault)



Relay (Optional)

Relay for remotely cut off/resume oil, please note that the devices should be matched with accessories to realize these functions

III. SIM card Installation

Open packing case, check terminal is OK and the accessories are intact, or please contact your dealer;

You need a suitable SIM card for using the terminal, please contact your dealer if you have any question;

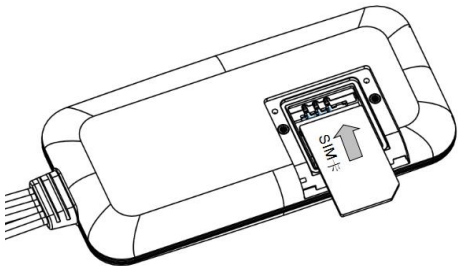

Insert SIM card to the device correctly

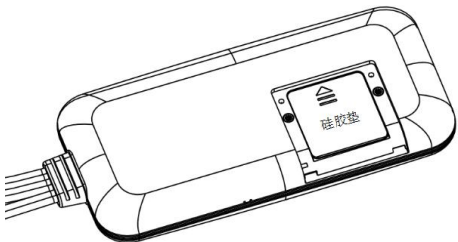

waterproof silicone must be put

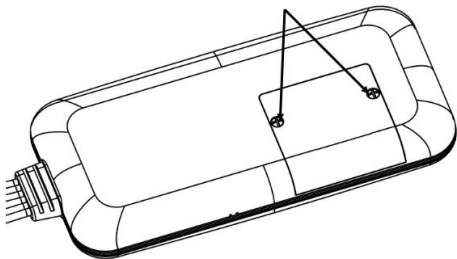

Tighten the screws after put the cover correctly

Note:

- Please cut off the power before installing or uninstalling the SIM card.
- The SIM card should have network to internet.
- SIM card should open Caller Identification function for telephone querying.
- If you enable the PIN code of the SIM card, please use your mobile phone to disable the PIN code.
- Please make sure that the SIM card has sufficient balance.

IV. Terminal Installation

4.1 Install the terminal

4.1.1 Please install the terminal concealed by professional person

Please make sure to install the terminal with this side upward, and use wide strong double-sided adhesive sponge to fix it.

Please make sure to install the terminal with this side towards the ground, and use wide strong double-sided adhesive sponge to fix it.

4.1.2 Installation Notice

- Hide the terminal properly inside the car body in order to avoid damages.
- Keep the terminal away from RF emission sources such as backing radar, car burglar alarm and other vehicle mounted communication devices.
- Suggest to use wide strong double-sided adhesive sponge to fix it, or use cable ties and other liable methods to fix it.
- Device Built-in WCDMA antenna and GPS antenna, Please ensure that signal receiving side is facing up(towards the sky) when doing installation,

without any metal material covered on the top. It may weaken signal and results in not work properly

The recommended installation location:

- 1) The hiding place below the front windshield trim panel;
- 2) The hiding place around the front dash (if the surface is not made of metal);
- 3) The place under the rear windshield;

4.2 Terminal wiring definition

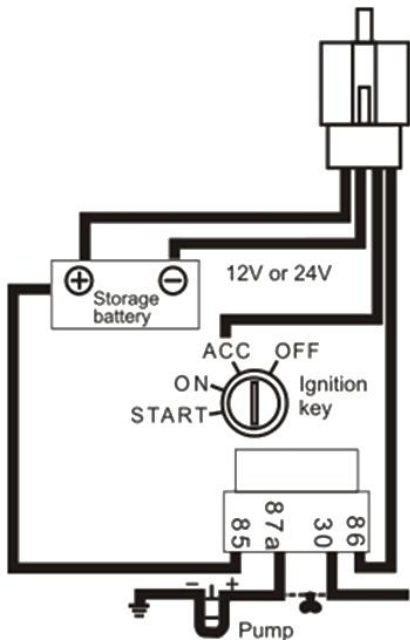

Total schematic wiring terminal

4.2.1 Power cables and other interface for remote control

The standard input voltage of the terminal is 7V-72VDC, so please choose the our original power cables, the red cable is positive and the black cable is negative; Please ground the positive pole separately or ground it to ground connection, not to any other ground.

Connect the ACC cable (orange cable) to ACC switch of the vehicle, then the position server can get the information about the vehicle power; the ACC cable can also be connected directly to the positive pole of the vehicle power, then the position server think that the vehicle is always ignited.

Connect the 4# cable (yellow cable) to the 86 terminal(with small yellow cable) of the relay. Use cable ties to fix the relay to waterproof place, or use plastic bags to cover the relay..

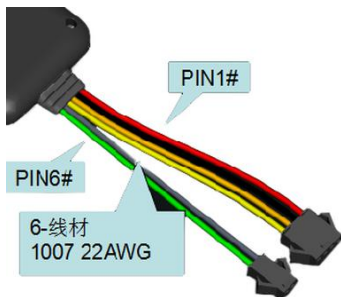

2P SM Male



5#	GPIO, 灰色	
6#	GPIO, 绿色	



1#	Power +, Red	
2#	Power -, Black	
3#	ACC, Orange	
4#	Relay, Yellow	

4.3 Relay wiring

Relay wiring diagram shows how to wire the relay to control the fuel pump:

4.3.1 Connect the 85 terminal (with small white cable) to the positive pole of the vehicle power (+12V/+24V), connect the 86 terminal (with small yellow cable) to the 4# cable of the terminal.

4.3.2 Cut off the positive pole of the fuel pump, next serial connect the positive pole to the 87a terminal (with thick green cable) of the relay, and connect another pole to 30 terminal (with thick green cable), showing as in the figure.



Bottom of the relay Wiring Diagram

Notice: Be sure that the voltage of the vehicle power should match up to the working voltage of the relay, or the relay will be damaged.

V. Power On / Off

5.1 Power on

Power on: insert a valid SIM card and wire all the cables, then the terminal power on itself.

5.2 LED Indicators

The red LED flickers fast when the terminal is searching for WCDMA network, it flickers

intermittently when the terminal has registered the WCDMA network successfully.

The blue LED flickers fast when the terminal is searching for the GPS satellite signal, it flickers intermittently when the terminal when the terminal has searched the satellites and can be positioned.

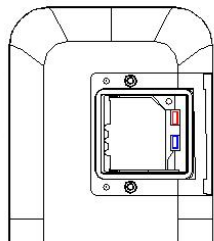

WCDMA/GSM LED

GPS LED

1. **Red LED**(indicates WCDMA/GSM working state)

Fast blinking	Searching for WCDMA/GSM network
Slow blinking	WCDMA/GSM works normally

2. **Blue LED**(indicates GPS signal state)

Fast blinking	Searching for GPS Satellites
Slow blinking	GPS works normally

5.3 Power off

Disconnect the external power and take off SIM card, after a while the terminal will shut down.

VI. Inquiry/Monitoring/Cut Oil

6.1 Inquiry by service platform

6.1.1 Web Browser platform

Login the service platform and enter your ID and password to check the position of the terminal. Please ask your dealer for the WWW address of the position service platform.

6.2.2 Smart phone applications

You can use a smart phone to check the terminal's position. We have prepare for you the Android client (Android), Apple clients (IOS), please check with your dealer to get installation package.

6.2 Inquiry by SMS

You can write a positioning SMS sending to the terminal to inquiry terminal position, the terminal will reply position SMS or map link. The SMS commands please refer to the Operation Commands

6.3 Cut Oil /Restore

6.3.1 Cut off oil circuits

The position server or the managers can send cut-off fuel commands when needed. The fuel of the vehicle will be cut off on the premise of safety, and the vehicle will not be powered on.

To make sure the safety of the vehicle, the fuel of the vehicle will be cut off only if the terminal has positioned by GPS and the speed of the vehicle is less than 20KM/h or the vehicle is not moving.

6.3.2 Recover oil circuits

The position server or the managers can send recover-fuel-circuit commands to the terminal when needed, the terminal will recover the fuel circuits of the vehicle.

VII. Terminal Alarm

7.1 Vibration Alarm

Conditions: When the Vehicle Vibration occurs.

Note: You need to set vibration sensitivity and time, there is an alarm switch.

7.2 Collision / falling Alarm

Conditions: When the Vehicle Collision or falling occurs.

7.3 Speed Alarm

Conditions: When the vehicle over and below the set speed.

Note: You need to set the low speed limit and high speed limit.

7.4 Shift Alarm

Conditions: When the vehicle occur the set shift in the Flameout state.

Note: Only valid in flameout state and vehicle occur the set shift distance.

7.5 Geo-fence Alarm

Conditions: when the vehicle entry / exit / across the Geo-fence.

Note: You need to set the conditions of crossing fence, fence types and so on.

7.6 Power disconnect Alarm

Conditions: When the device is disconnected from external Power.

7.7 Low battery Alarm

Conditions: When the device is disconnected from

external Power and built-in battery power falls below a certain value .

Note: When above alarm occurs, the terminal will send alarm to service platform, meanwhile send a SMS message to the administrator number if the number is set.

Note: Alarm parameters must be set before work in 7.1, 7.3, 7.4 & 7.5 , Please refer to the <**Operation Commands**>

VIII. Terminal Setting

Please refer to the <**Operation Commands**>

IX. Trouble shooting

9.1 Cannot connect platform

The terminal is never online on the position server when installed at the first time. Please check the terminal:

1) If the power cables are wired correctly? Pay attention to not connect them to the controlling

cables of the vehicle.

2) If the SIM card is installed correctly? Please refer to the installation instructions.

3) Check the status of the LED indicators. If the terminal is OK, the red LED and the blue LED will intermittently flick.

4) Inquiry the parameters of terminal via commands and check the accuracy of the parameters.

9.2 Offline status

First check if the LED indicators are OK, if cannot check them, you can check the SIM card following next steps:

1) call the SIM card of the terminal and check if you can hear the connecting ring.

2) Check if the vehicle is in the area where there is no WCDMA signal.

3) Check if one terminal or all terminals are offline in the area where terminal is offline. If all terminals are offline, you should ask the network operator if the network is OK.

- 4) Check if the SIM card has enough balance.
- 5) If the terminal becomes offline on the last day of one month, please check network is closed or not.
- 6) Inquiry the parameters of terminal via commands and check the accuracy of the parameters.

9.3 No positioned

If the GPS is active, but the terminal cannot be positioned for long time, please check the terminal:

- 1) If the vehicle is in the place where there is no GPS signal.
- 2) The upside of the terminal should be installed with face toward the sky.
- 3) The WCDMA and GPS signal may be weakened if the terminal is installed in the place with electromagnetic wave absorption material (such as metal blocks), special attention should be paid if there is metal thermal insulation layer or heating layer on the front windshield, so that the position accuracy will decline, and the severe ones will not be positioned.

9.4 Position drift

Serious position drift will be found in places where GPS signal is poor. Please drive the vehicle to the open places.

9.5 Commands receiving abnormally

- 1) Check the commands format.
- 2) Check if the vehicle is in the places where there is WCDMA signal.
- 3) Check if the SIM card is properly installed.

X. Warranty rules

10.1 Special statement

- 1) Technology change without notice.
- 2) If the color and appearance are inconsistent with those for the actual product, the latter will prevail.
- 3) Warranty card is only valid for the terminals with the following IMEI.
- 4) Please take care of the warranty card and show it with the original purchase receipts when enjoying the warranty service.

10.2 Warranty period

Since the date of purchase, passive waste host has one year warranty.

10.3 After sales

Any of the following circumstances not covered by the warranty, but may be appropriate to pay repair:

- 1) More than the warranty period.
- 2) Unauthorized removal or repair damaged.
- 3) Damage caused by improper installation, use, maintenance, custody.
- 4) The IMEI label is torn or Obscure.
- 5) Warranty certificate and product models do not match or warranty certificate be altered.
- 6) Damage caused by force majeure.

Warranty Card/保修卡

NAME/姓名 _____

TEL/电话 _____

Address/地址 _____

Model/机型 _____

IMEI Number (IMEI 号)



Selling Unit/经销商 _____

Purchase Date / 购买日期

_____YY/年_____MM/月_____DD/日

Maintenance records / 维修记录

Date 日期	Description 故障描述	Records 维修记录	Completion Date 完成日期	Engineer 维修人员