

# EUMETNET OPERA weather radar information model for implementation with the HDF5 file format Version 2.4.1

Original authors:

Daniel B. Michelson<sup>1</sup>, Rafał Lewandowski<sup>2</sup>, Maciej Szewczykowski<sup>2</sup>, and Hans Beekhuis<sup>3</sup>

Additional author:

Günther Haase<sup>1</sup>

<sup>1</sup>Swedish Meteorological and Hydrological Institute, Norrköping, Sweden

<sup>2</sup>Institute of Meteorology and Water Management, Warsaw, Poland

<sup>3</sup>Royal Netherlands Meteorological Institute, De Bilt, Netherlands

# EUMETNET OPERA weather radar information model for implementation with the HDF5 file format

Version 2.4.1

Original authors:

Daniel B. Michelson<sup>1</sup>, Rafał Lewandowski<sup>2</sup>,  
Maciej Szewczykowski<sup>2</sup>, and Hans Beekhuis<sup>3</sup>

Additional author:

Günther Haase<sup>1</sup>

<sup>1</sup>Swedish Meteorological and Hydrological Institute, Norrköping, Sweden

<sup>2</sup>Institute of Meteorology and Water Management, Warsaw, Poland

<sup>3</sup>Royal Netherlands Meteorological Institute, De Bilt, Netherlands

on behalf of EUMETNET OPERA

July 1, 2024

## **Abstract**

This document specifies an information model with which the encoding, decoding and management of data and products from weather radar systems may be facilitated, primarily for the purposes of international exchange in Europe. An implementation of this information model is also specified which makes use of the HDF5 file format developed and maintained by the HDF Group. The result manifests itself in the form of truly self-describing weather radar data files highly suitable for environments where data exchange between radars from different manufacturers, different organizations, and/or different countries is conducted. The ability to include quality information, in the forms of metadata and binary arrays, is included in a powerful and flexible manner. This information model constitutes an official second-generation European standard exchange format for weather radar datasets. Because the netCDF file format is built on HDF5, we also try to ensure that our information model will be compliant with netCDF.

## RELEASE NOTES

### Version 2.4.1, 1 February 2024

Chapters 4.2, 4.5, and 7.2 have been updated to clarify the location of the what Attributes, e.g. **dataset-specific** what header Attributes "quantity", "gain", "offset", "nodata", and "undetected" should be placed in /datasetX/dataY/what. Furthermore, a new how Attribute `missing_nodes` has been added to Table 8.

### Version 2.4, 1 July 2021

In addition to the optional how Attributes a few mandatory how Attributes have been defined to facilitate the use of radar data for e.g. NWP. Even the NOD identifier in /what/source is now mandatory. Two-dimensional how Attributes (e.g. melting layer height, parameters in the Z-R and KDP-R relationships) have been introduced. Moreover new attributes (e.g. pulse repetition time, radar tower height, applied method to derive the vertical profile) and quantities (e.g. unfiltered SNR) have been added. Note that all new attributes and quantities follow the CfRadial2 conventions. Definitions and descriptions have been improved and SI units are applied where applicable.

### Version 2.3, 9 January 2019

The list of how Attributes has been split into highly desirable and recommended attributes. User-definable subgroups (including sub-subgroups) may be added to existing how groups: e.g. `how/rsp` (radar signal processor parameters), `how/radar_parameters` (general radar system parameters), `how/bite` (BITE information), `how/radar_monitoring` (external monitoring information), `how/radar_scheduling` (additional scheduling information), `how/radar_processing_chain` (processing chain), and `how/noden`, where  $n$  is the index of a radar node included in a composite. User-definable attributes may be added to these subgroups. Quantities that have not been subject to any filter or correction have been added. The WIGOS identifier is now included in the list of source type identifiers.

### Version 2.2, 21 March 2014

Table 8 contains additional how Attributes for all objects while new quantities have been added to Table 16. Some attributes (like TXloss, RXloss, SQI, SNR, VRAD, and WRAD) were assumed to be horizontally-polarized only. For consistency and clarity attributes that exist in both H and V polarization are denoted accordingly. The new ODIM version also contains a minimum specification for a vertical profile and a polar RHI representation. The latter resembles sector objects and scans. Table 2 includes a new file object "ELEV" (Elevational object) to accommodate this polar representation. The ELEV object may only contain the polar product `how/product` "RHI" as already specified in Table 14. Previously existing quantities have been marked for deprecation. Optional Attributes with ambiguous polarities have been removed where new attributes supersede them.

### Version 2.1, 28 April 2011

The "simple array" type has been introduced and some attributes have been redefined to use it. The /what/source attribute has undergone revision. Several new optional how metadata attributes have been added. Section 7 has been reformulated to also identify prioritized optional how attributes in support of various applications. Clarifications have been added where ambiguities have been found, and errors have been corrected. Due to the scope of the changes introduced, this version has been incremented to the next minor version number.

**Version 2.0.1, 21 September 2010**

The composite object and product are now officially accepted as OPERA standard. A couple of clarifications have been made, without changing any of the contents of the information model itself. The UML annex has been broken out to be its own working document. To mark this, and that we've released an updated document, a minor-subversion has been introduced.

**Version 2.0, 9 June 2009**

A few inconsistencies between metadata in the tables and the diagrams in the UML representation have been identified and corrected. These fixes do not motivate a version number increment.

**Version 2.0, 1 June 2009**

This is the first version of ODIM\_H5 to be officially accepted as an OPERA standard. Notwithstanding this status, the official parts are the definitions of polar scans and volumes, along with all associated metadata. All other objects retain their draft status, and will achieve official status in due course, subject to approval in OPERA.

## Contents

<b>1</b>	<b>Introduction and motivation</b>	<b>1</b>
<b>2</b>	<b>Information model concept</b>	<b>2</b>
<b>3</b>	<b>Definitions</b>	<b>7</b>
3.1	Scalars (integers, real values, and strings)	7
3.1.1	Booleans	7
3.1.2	Sequences	7
3.1.3	Simple arrays	8
3.2	Attributes	8
3.3	Datasets	8
3.4	Groups	8
<b>4</b>	<b>Metadata attribute specification</b>	<b>9</b>
4.1	Root Group	9
4.2	Top-level what Group	10
4.3	where Group	11
4.3.1	where for polar data Groups	11
4.3.2	where for geographically referenced image Groups	12
4.3.3	where for cross-section data Group	13
4.3.4	where for vertical profiles	14
4.4	how Group	15
4.5	what Group for Dataset objects	27
<b>5</b>	<b>Data specification</b>	<b>33</b>
5.1	Polar Data	34
5.2	Image Data	34
5.3	RHIs, cross sections and side panels	34
5.4	Profiles	35
5.5	Rays and sectors	35
5.6	Embedded graphical images	35
<b>6</b>	<b>Optional objects</b>	<b>36</b>
6.1	Palettes	36
6.2	Legends	36
<b>7</b>	<b>Mandatory metadata per product</b>	<b>39</b>
7.1	Polar volume	39
7.2	Composite	41
7.3	Vertical profile	43
7.4	RHI	44
<b>A</b>	<b>Derivation of the radar calibration constant</b>	<b>46</b>

## List of Tables

1	Mandatory top-level what header Attributes for all weather radar files. . . . .	10
2	File object strings and their meanings. . . . .	10
3	Source type identifiers and their associated values. . . . .	11
4	where Attributes for polar data objects. . . . .	12
5	where Attributes for geographical image data Groups. . . . .	13
6	where Attributes for cross-section data. . . . .	14
7	where Attributes for vertical profiles. . . . .	14
8	how Attributes for all objects. Shading indicates mandatory Attributes for single-site data depending on the polarization mode applied and the moments provided (e.g. NI can be omitted if no radial velocity data are available). The non-shaded Attributes are optional. . . . .	15
9	Examples radar “places” and their node designations. . . . .	25
10	Radar system abbreviations and their meanings. . . . .	26
11	Processing Software abbreviations and their meanings. . . . .	26
12	Method abbreviations and their meanings. . . . .	27
13	Dataset-specific what header Attributes. . . . .	27
14	Product abbreviations and their meanings. . . . .	28
15	Product parameters. . . . .	29
16	Quantity (variable) identifiers. . . . .	29
17	Mandatory 8-bit Image attributes. <b>Note</b> that these are part of a Dataset object. . . . .	33
18	Example for a hydrometeor classification legend. . . . .	37
19	Polar volume. . . . .	39
20	Cartesian image with palette. . . . .	42
21	Vertical profile. . . . .	43
22	Range-height indicator. . . . .	44

## 1 Introduction and motivation

During OPERA's second incarnation, the goal of work package 2.1 "HDF5 exchange software development" was to formulate a second-generation information model for use with weather radar data and the Hierarchical Data Format version 5 (HDF5) file format. This information model has since been adopted and implemented in operational software both inside and outside OPERA.

This document presents an information model developed for use with weather radar data and products. Its implementation is also presented, which makes use of the HDF5 file format. HDF5 is developed and maintained by the HDF Group. All references to attributes, data, types, and so on, are in relation to those defined and used in the HDF5 documentation. The official HDF5 format documentation should be consulted for details on this format. This information model is an elaboration of the model presented by COST 717 and used in real-time operations in the Nordic countries<sup>1</sup>. Several enhancements have been made based on operational experience, and based on data quality issues addressed in OPERA II and the EU Voltaire project. The model presented here is not backwardly compatible with previous versions (version 1.2 and earlier), but the advantages of its new structure outweigh this disadvantage.

The information model given here is designed from the point of view of trying to harmonize all relevant information independently of the radar manufacturer and organization from which the data originates. While the information model is intended to enable the representation of the data and products agreed upon today within the framework of EUMETNET OPERA, we also look ahead to future needs and have tried to ensure that they are appropriately met with this information model. This means that the known products are supported, as are polarization diversity variables and virtually any quality-related information characterizing a given dataset. It is also vital to recognize the importance of being able to represent polar (spherical coordinate space) data, and this is accommodated as well in a flexible manner.

This information model has become the modern European standard, and as such can be used in forthcoming meteorological standard exchange mechanisms, ie. the WMO Information System (WIS) and its infrastructure. There is also an important link to OPERA's operational data centre (Odyssey), in that quality information in the information model is being used by Odyssey, thus supporting efforts to improve the quality of operational products covering the European continent.

In this way, weather radar data and products are well-organized for data exchange infrastructure, and we have tried to ensure that the use of the modern technology will facilitate access to and use of European radar data both within and outside the meteorological community.

---

<sup>1</sup>Michelson D.B., Holleman I., Hohti H., and Salomonsen M., 2003: HDF5 information model and implementation for weather radar data. COST 717 working document WDF\_02\_200204\_1. version 1.2.

## 2 Information model concept

The information model attempts to achieve a general-purpose model for storing both individual scans, images and products, while also allowing series (time and/or space) of these types of information to be stored using the same building-blocks. The hierarchical nature of HDF5 can be described as being similar to directories, files, and links on a hard-drive. Actual metadata are stored as so-called “attributes”, and these attributes are organized together in so-called “groups”. Binary data are stored as so-called “datasets”. The challenge in formulating an information model is in defining the way in which these general building-blocks are organized. This section illustrates the information model defined in detail later in this document, in an attempt to present and clarify its structure.

The first example is given in Figure 1, which shows how a simple Cartesian product, for example a CAPPI, is represented. At the top level, the HDF5 file contains the so-called “root” group. This group is always there. Following that, three groups contain metadata; these are called “what” (object, information model version, and date/time information), “where” (geographical information), and “how” (quality and optional/mandatory metadata). The data is organized in a group called “dataset1” which contains another group called “data1” where the actual binary data are found in “data”. This organization may seem overly complicated at first, but we will see shortly how powerful and necessary this organization is.

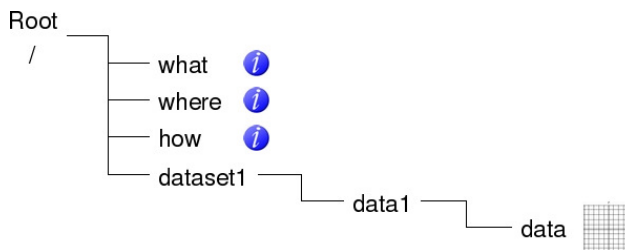

Figure 1: Cartesian product.

In terms of the analogy with a file system on a hard-disk, the HDF5 file containing this simple Cartesian product is organized like this:

```

/
/what
/where
/how
/dataset1
/dataset1/data1
/dataset1/data1/data
    
```

In Figure 2, the exact same structure is used to represent a polar scan of data.

When we use this structure to represent a complete scan of data containing three parameters, the seemingly complicated organization used to store the binary data becomes easier to understand. Figure 3 shows how “dataset1” now contains three “data” groups, each containing a binary array of data. What we also see is the way in which the metadata groups “what” and “where” can be used recursively to hold metadata which are unique to their place in the hierarchy. In this case, “where” in “dataset1” contains the elevation angle of the scan used to collect the three parameters, and the three local “what” groups contain the information on which parameter is stored in each. In this way, “dataset1” can contain Z, V, and W in this case, but it can also contain an arbitrary number of other parameters.



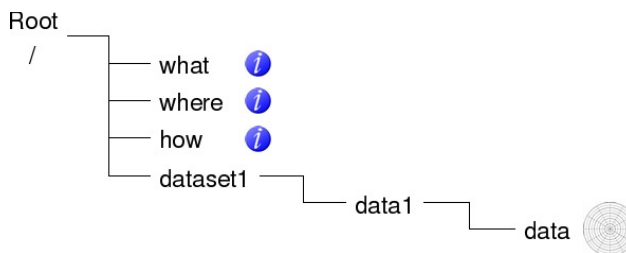

Figure 2: Simple polar scan.

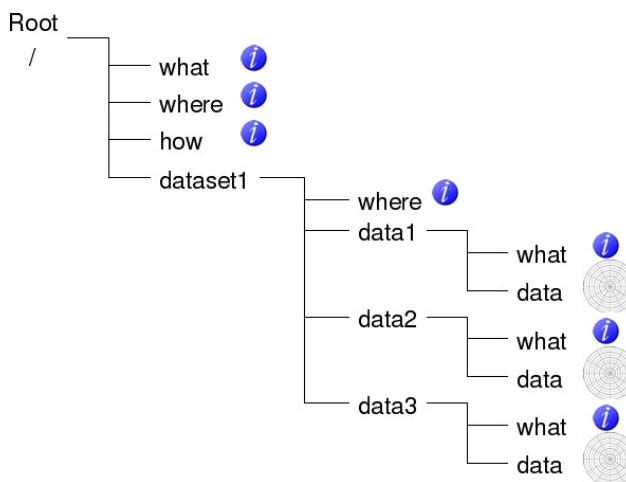

Figure 3: A complete polar scan containing three parameters.

The use of dataset-specific metadata groups is illustrated in Figure 4. Both methods of using “what”, “where” and “how” are acceptable. In the example on the left, the metadata groups contain attributes which are valid for every dataset in that group. In the case on the right, the metadata groups contain attributes which are valid only for that single dataset. In Figure 3, “where” is valid for all three datasets in the group, whereas “what” is only valid locally. The local metadata always have top priority, so if a mistake is made where a file contains the same metadata at different levels, the most local level will always take precedence.

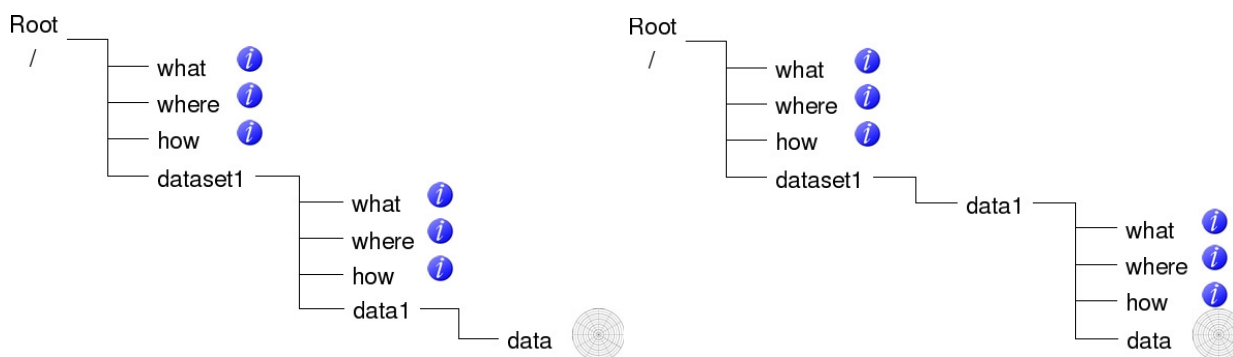

Figure 4: Use of dataset-specific metadata groups.

Continuing from the single scan in Figure 3, we can easily extend the same structure every time we want to add a new scan. This is illustrated in Figure 5. Here, the new elevation angle will be stored in /dataset2/where, and the information on the parameters stored in the datasets are found in each lo-

cal “what”. **Note** that optional/mandatory metadata can be added in a “how” group either directly under “dataset2” or together with each parameter, but this hasn’t been included in this example. A complete volume containing an arbitrary number of scans, each containing an arbitrary number of parameters, is organized using this structure. A Cartesian volume can be constructed in exactly the same way. Time series of polar or Cartesian products can be constructed in the same way too.

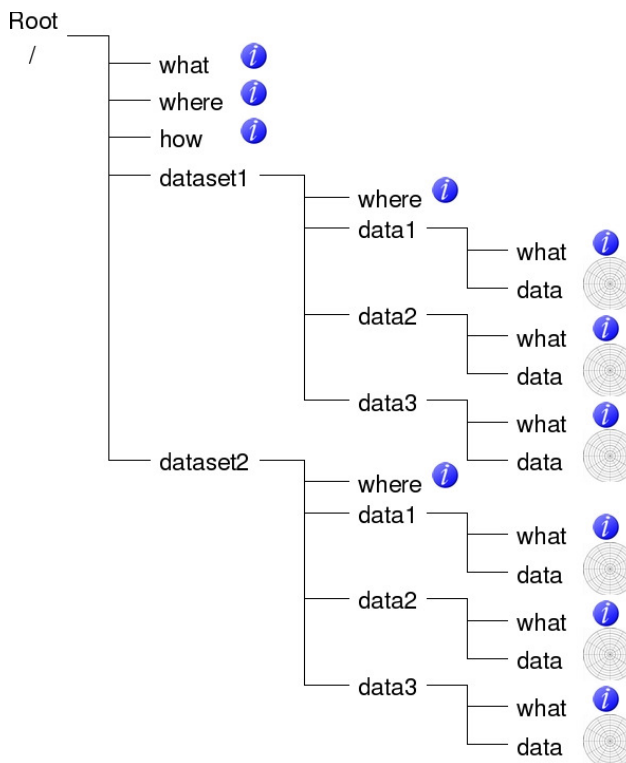

Figure 5: A polar volume containing two scans.

This information model uses the same logic to include the representation of **quality information**. Figure 6 illustrates how quality data can be added to polar data in a scan containing two parameters. In the same way that metadata can be applicable to all parameters in the scan, so too can quality information be representative either generally or locally. In this example, `/dataset1/quality1` can contain quality based on beam blockage since this is applicable to all parameters collected at the same elevation angle. However there may be different quality metrics which are applicable to each individual radar parameter, and these are stored locally. In this case, “data1” contains two such local quality metrics which are unique to that parameter, whereas “data2” only contains one. And we also see that each quality metric can be described using local metadata groups. The quality metrics should follow the guidelines set out in OPERA II<sup>2</sup>.

Using this hierarchical structure, it becomes clear that we now have an information model capable of representing a volume containing an arbitrary number of scans/images, each of which can contain an arbitrary number of parameters which, in turn, can be characterized by an arbitrary number of quality metrics.

The examples provided in this discussion have focused on polar data, but they can also be applied to all the objects supported in this information model. These objects are polar scans, Cartesian images, profiles, RHIs, cross-sections, side-panels, individual rays, sectors, and even embedded graphics images in an industrial

<sup>2</sup>Holleman I., Michelson D., Galli G., Germann U., and Peura M., 2006: Quality information for radars and radar data. OPERA II deliverable OPERA\_2005\_19.

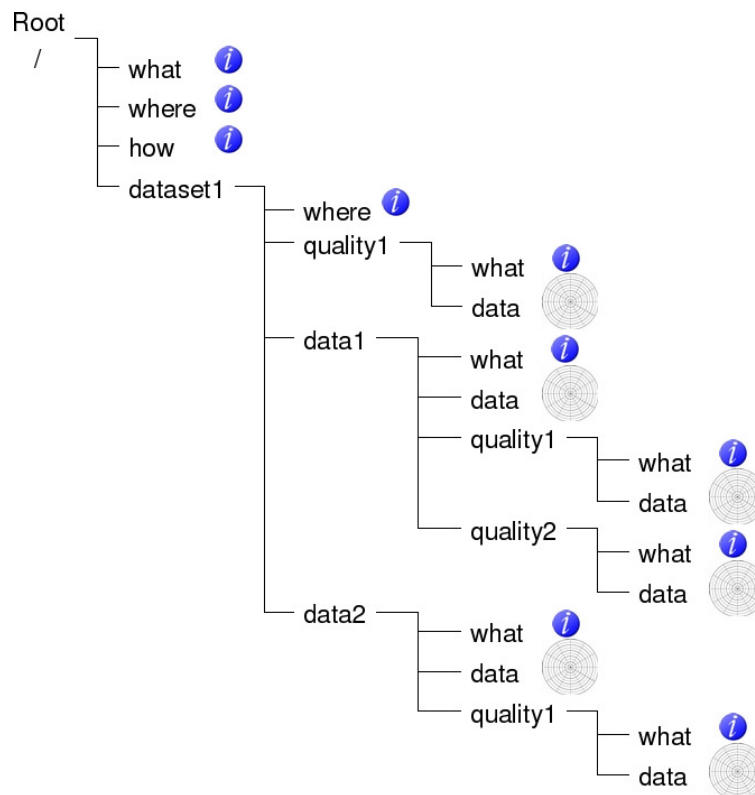

Figure 6: A polar scan containing two parameters and associated quality metrics.

graphics file format.

There are additional objects which are *complementary* to this information model and which are included since they are quite useful in various situations. One of them is the ability to add a color palette to an 8-bit dataset. There are standard mechanisms for this in the HDF5 library, and these are used without modification. Another object is a legend. This is a useful object when the data in a dataset is classified, discrete, or just level-sliced. The legend provides the ability to describe which quantitative values are represented by each qualitative value in the dataset, or which qualitative class is represented by a given value. The legend is used to tell the user that a certain value in the data represents e.g. “0.1–0.5 mm/h” in the case of a rainrate product, and e.g. “sleet” in the case of a hydrometeor classification. Both the palette and the legend objects are illustrated in Figure 7.

Finally, this information model enables the exchange of graphics representations of data. Using the same structure as that shown in Figure 1, Figure 8 illustrates this.

In the rest of this document, the detail specification of the information model is presented. With this specification, it shall be possible to read, write, and understand HDF5 files using this information model.

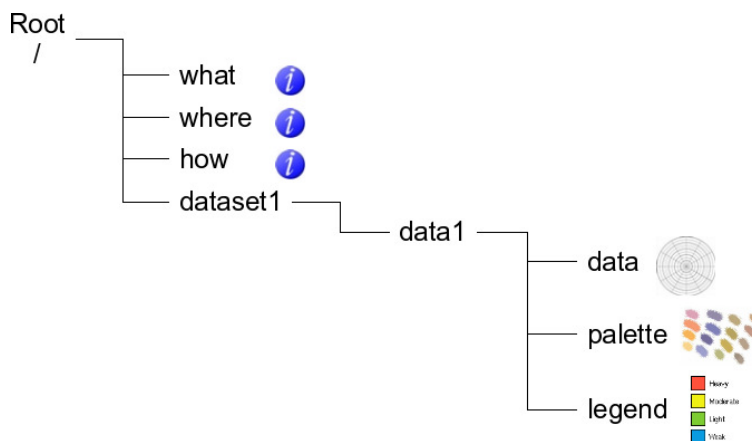

Figure 7: A polar scan containing a color palette and a legend.

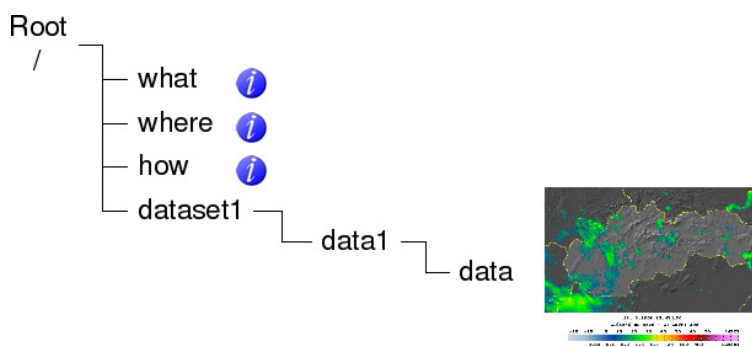

Figure 8: An embedded Slovak picture in an industrial graphics file format.

## 3 Definitions

HDF5 allows data to be stored as `Attributes`, `Datasets`, `Groups`, and user-defined `Compound` types. For use here, all types except user-defined `Compound` are permitted for use. Only `Compound` types defined in this document are permitted, in practise the optional legend object described in Section 6.2. In practice, all of these types are manipulated through the use of general-purpose `Node` objects, i.e., a `Node` may be any of the above mentioned types.

### 3.1 Scalars (integers, real values, and strings)

Scalar values are stored in `Attribute` objects and may be strings, integers, or real (floating-point) values. For the sake of consistency and simplicity, integer values shall be represented as 8-byte `long`, and real values shall be represented as `double`. These can be written to file as native types. They will be read and automatically returned as the corresponding native type on another platform. Endianness is therefore no cause for concern.

A clarification is however necessary; a `long` on one machine may have a different length than that on another machine. This is because a native `long` could, perhaps, be returned as an `int` in some cases. To prevent this, you should ensure that all integer scalar attributes are written with a length of 8 bytes. In some cases, this may require writing values of type `long long`, but it can also be enforced on POSIX-compliant systems by using the `int64_t` typedef.

Strings shall be encoded in ASCII or the ASCII representation of UTF-8. Strings should never be terminated by the application, because they shall be automatically null-terminated by the HDF5 library. This is done by setting the string termination to `STRPAD=H5T_STR_NULLTERM`. Other methods of termination available in the HDF5 library shall not be used. It is also necessary to specify the length of each string (`STRSIZE`). Even when `H5T_STR_NULLTERM` is used, the value of `STRSIZE` must be incremented manually by one to ensure that it includes the `NULL` character. Other methods of specifying the length of the string provided by the HDF5 library (ie. `H5T_VARIABLE`) shall not be used.

#### 3.1.1 Booleans

A string is used to store truth value information. The string “`True`” is used to represent true, and “`False`” is used to represent false.

#### 3.1.2 Sequences

A special kind of string may be used to store sequences. A sequence contains comma-separated scalar values in string notation. For example, a sequence is useful for storing the radar stations contributing to a composite image, and in storing the elevation angles used in a polar volume of data.

### 3.1.3 Simple arrays

Sometimes it is necessary to store numeric metadata whose geometry corresponds with the number of azimuth gates in a scan or bins along a ray, or both. The simple array provides this ability. Instead of using a complete HDF5 Dataset object provided by the HDF5 library (H5D Dataset interface), the simple array uses the H5S dataspace interface. To simplify this further, only one- and two-dimensional simple arrays are allowed, and to remain consistent with scalar integer and real value attributes, the simple arrays shall contain either “long” integers or “double” floats, as defined above.

## 3.2 Attributes

An `Attribute` is an HDF5 object used to store a header attribute or data. For our purposes, it is only used to store header attributes. In order to facilitate the management of so-called “atomic” attributes, ie. individual values, we use double precision for both integers (long) and floating-point (double) values. **Note** that the specification of strings is intended to be case sensitive.

## 3.3 Datasets

An HDF5 Dataset is a self-describing data object containing an  $n$ -dimensional binary array and attributes describing it. The array type may be any of `char`, `schar`, `uchar`, `short`, `ushort`, `int`, `uint`, `long`, `ulong`, `llong`, `ullong`, `float`, `double` on a given platform.

In this document the text formatting of `Dataset` (in Courier font) means an HDF5 dataset, whereas the text formatting of **dataset** (in bold face) refers to the binary data in that dataset.

## 3.4 Groups

A `Group` is a top-level object which is used to organize other objects. For example, a `Group` may contain a collection of header `Attributes`, a collection of `Datasets`, or be the root object for the complete contents of an HDF5 file.

## 4 Metadata attribute specification

Header attributes are collected in three `Group` objects, all of which may be used recursively. `Attributes` which describe a given file's contents and the time and place for which it represents are collected in a `Group` called `what`. `Attributes` which describe a given file's geographical characteristics (projection, corner coordinates, dimensions, scales) are collected in a `Group` called `where`. The `what` and `where` `Groups` both contain mandatory `Attributes` only. Those `Attributes` which collectively describe additional data/product characteristics, such as radar system, chosen algorithm, and quality-related meta-data, are stored in a `Group` called `how`. All `Attributes` found in `how` may be considered optional or mandatory. Additional `Attributes` not specified in this document may only be stored in the `how` `Group`.

Top-level header attributes are collected in `what`, `where` and `how` `Group` objects located directly under the root `Group` `'/'`. Each attribute is stored as an `Attribute` object containing a scalar value. Some data/products may have `Dataset`-specific header attributes, in which case the `Dataset` and its header `Attributes` are collected in lower-level `what`, `where` and `how` `Groups` which are associated with that `Dataset`.

The concept used here is that each `Attribute` is identified with a string, the idea being that this is a more intuitive means of organizing data compared to numeric descriptors. It also means that a file may be queried using the `h5dump` utility to easily see and understand the contents of a file.

Mandatory header attributes for all files are given in Table 1.

**Note** that all date and time information is for the **nominal time** of the data, ie. the time for which the data are valid. (The nominal time is not the exact acquisition time which is found elsewhere in the file.)

**Note** that all scans belonging to the same volume must have the same nominal date and time.

**Note** that all geographical longitude/latitude coordinates are specified with positive easting values east of the Greenwich meridian and positive northing values north of the equator.

**Note** that by convention, the “polarization” of electromagnetic waves refers to the direction of the electric field.

### 4.1 Root Group

No HDF5 file can exist without this `Group`, since it is the starting point of the hierarchy. However, in order to take the first steps towards interoperability with Climate and Forecast (CF) Conventions, we require an `Attribute` in the root `Group`. This `Attribute` is called “Conventions” and its value is a string containing the acronym of the information model being used, and its version, in a format which lends itself to a directory structure. This is done to comply with the documentation policy maintained by the community managing CF Conventions<sup>3</sup>.

This information model is called the “OPERA Data Information Model for HDF5” which gives the acronym “ODIM\_H5”. Recognizing the history of this information model, we start at version 2.0. The resulting value for “/Conventions” is “ODIM\_H5/V2\_0”, and this `Attribute` must be present in all ODIM\_H5 files.

<sup>3</sup><http://cfconventions.org/>

The present version is 2.4, which translates to “ODIM\_H5/V2\_4”.

### 4.2 Top-level what Group

In this section the content of the top-level what is described.

This Group contains mandatory Attributes only which collectively describe a given file’s contents. These Attributes are given in Table 1.

Table 1: Mandatory top-level what header Attributes for all weather radar files.

Name	Type	Format	Description
object	string	-	According to Table 2
version	string	H5rad M.m	Format or information model version. “M” is the major version. “m” is the minor version. Software is encouraged to warn if it receives a file stored in a version which is different from the one it expects. The software should, however, proceed to read the file, ignoring Attributes it does not understand. <b>Note</b> that this Attribute shall be synchronized with “/Conventions”.
date	string	YYYYMMDD	Nominal Year, Month, and Day of the data/product
time	string	HHmmss	Nominal Hour, Minute, and Second, in UTC of the data/product
source	string	TYP:VALUE	Variable-length string containing pairs of identifier types and their values, separated by a colon. Several pairs can be concatenated, separated by commas, in the form TYP:VALUE,TYP:VALUE, etc. For single-site data the NOD identifier is mandatory, for composites the ORG identifier is mandatory (Table 3). All identifiers assigned to a given radar shall be provided.

Object strings may be any of those given in Table 2. For each Dataset, there may be an accompanying what Group with information specific to that Dataset, according to Table 13.

Table 2: File object strings and their meanings.

String	Description
PVOL	Polar volume
CVOL	Cartesian volume
SCAN	Polar scan
RAY	Single polar ray
AZIM	Azimuthal object
ELEV	Elevational object
IMAGE	2-D cartesian image
COMP	Cartesian composite image(s)
XSEC	2-D vertical cross section(s)

*continued on next page*



*continued from previous page*

String	Description
VP	1-D vertical profile
PIC	Embedded graphical image

**Note** that a file containing a single scan of polar data may not be represented using object type PVOL; the object type in these cases must be SCAN. **Note** also that an RHI polar volume can be represented using a number of `Datasets` and the `ELEV` object.

Table 3: Source type identifiers and their associated values.

Identifier	Description	Example
WIGOS WMO	WIGOS (WMO Integrated Global Observing System) identifier Combined WMO block and station number in the form $A_1b_wnnnn$ , or 0 if none assigned. The first two digits represent the block number, where the first digit $A_1$ is the regional association area and the second digit $b_w$ is the sub-area. Remaining digits are the station number. (According to the WMO, numbers in the form $A_1b_wnnn$ are considered equivalent to the form $A_1b_w00nn$ ).	WIGOS:0-246-0-101234 WMO:02954
RAD	Radar site as indexed in the OPERA database.	RAD:FI44
PLC	Place according to the left column of Table 9 of this document	PLC:Anjalankoski
NOD	Node according to the right column of Table 9 of this document. Mandatory to identify single-site data.	NOD:fianj
ORG	Originating centre according to BUFR descriptor 0 01 033. Mandatory to identify composites.	ORG:86
CTY	Country according to BUFR descriptor 0 01 101	CTY:613
CMT	Comment: allowing for a variable-length string	CMT:Suomi tutka

### 4.3 where Group

In this section the `Attributes` for the `where Group` are described. These are different for polar or cartesian `Datasets`, i.e. containing `Dataset` and `Dataset Groups` respectively.

**Note** that the use of the `where Group` is mandatory but that its placement will be at the top level of a given file, and/or at a lower level associated with a given `Dataset`. This is because some attributes are valid globally (e.g. the coordinates of a radar) whereas others are local (e.g. the elevation angle used for a given sweep).

#### 4.3.1 where for polar data Groups

This `where Group` contains mandatory `Attributes` only which collectively describe geographical and geometrical characteristics of a given `Dataset` **dataset**. **Note** that the **dataset** itself is the object containing the binary data and that `where` in this context describes that **dataset** but is located in the corresponding

Dataset which contains all these objects. Section 2 illustrates how these two objects are related to each other.

Polar data, i.e. raw radar data as a function of azimuth and range, are stored in a Dataset Group, and polar volume data are stored as a stack of these Dataset Groups. Each Dataset Group contains azimuthal data from a single elevation.

Table 4: where Attributes for polar data objects.

Name	Type	Units	Description
lon	double	degrees_east	Longitude position of the radar antenna, normalized to the WGS-84 reference ellipsoid and datum. Fractions of a degree are given in decimal notation.
lat	double	degrees_north	Latitude position of the radar antenna, normalized to the WGS-84 reference ellipsoid and datum. Fractions of a degree are given in decimal notation.
height	double	meters	Height of the centre of the antenna above mean sea level
Dataset specific			
elangle	double	degrees	Antenna elevation angle above the horizon
nbins	long	–	Number of range bins in each ray
rstart	double	meters	The range of the start of the first range bin
rscale	double	meters	The distance between two successive range bins
nrays	long	–	Number of azimuth or elevation gates (rays) in the object
algate	long	–	Index of the first azimuth gate radiated in the scan
Sector specific			
startaz	double	degrees	The azimuth angle of the start of the first gate in the sector
stopaz	double	degrees	The azimuth angle of the end of the last gate in the sector
startel	double	degrees	The elevation angle of the start of the first gate in the sector
stopel	double	degrees	The elevation angle of the end of the last gate in the sector

### 4.3.2 where for geographically referenced image Groups

This where Group contains mandatory Attributes only which collectively describe a given Dataset's geographical and geometrical characteristics. **Note** that the **dataset** is the object containing the binary data and that **where** in this context describes that **dataset** but is located in the corresponding Dataset which contains all these objects. Section 2 illustrates how these two objects are related to each other.

The PROJ.4 cartographic projections library<sup>4</sup> is a comprehensive means of managing geographically referenced information which has become a *de facto* standard. PROJ.4 is being used increasingly throughout Europe and the world. As a result, the most straightforward way of representing projection information in radar files is by means of the projection definition string which is used with the library itself. For example, the arguments used with PROJ.4 to define the Google Maps projection are `+proj=merc +lat_ts=0 +lon_0=0 +k=1.0 +R=6378137.0 +nadgrids=@null +no_defs` so this is what should be found as an Attribute in the where Group associated with the Dataset used to store the data geo-

<sup>4</sup>Originally from the United States Geological Survey, now from MapTools

located using this projection. Similarly, the standard “longitude, latitude” projection, also known as EPSG 4326, is defined as `+proj=latlong +ellps=WGS84 +datum=WGS84 +no_defs`.

**Note** that PROJ.4 contains a complete set of arguments for specifying a given projection, including false easting/northing, rescaling of coordinates, choice of ellipsoid (or defining your own), choice of geodetic datum, and defining oblique (rotated) projections.

Table 5: `where` Attributes for geographical image data Groups.

Name	Type	Units	Description
<code>projdef</code>	string	–	The projection definition arguments, described above, which can be used with PROJ.4. See the PROJ.4 documentation for usage. Longitude/Latitude coordinates are normalized to the WGS-84 ellipsoid and geodetic datum.
<code>xsize</code>	long	–	Number of pixels in the X dimension
<code>ysize</code>	long	–	Number of pixels in the Y dimension
<code>zsize</code>	long	–	Number of vertical layers. Only used for three-dimensional products.
<code>zstart</code>	double	meters	Height above mean sea level of the lowest pixel in the Z dimension. Marked for DEPRECATION. To be replaced by <code>where</code> Attributes “ <code>ztop</code> ” and “ <code>zbottom</code> ”.
<code>xscale</code>	double	meters	Pixel size in the X dimension, in projection-specific coordinates
<code>yscale</code>	double	meters	Pixel size in the Y dimension, in projection-specific coordinates
<code>zscale</code>	double	meters	Pixel size in the Z dimension. Marked for DEPRECATION. To be replaced by <code>where</code> Attributes “ <code>ztop</code> ” and “ <code>zbottom</code> ”.
<code>ztop</code>	simple array of doubles	meters	Layer top heights above mean sea level. The size of this one-dimensional array corresponds with the number of vertical layers. Only used for three-dimensional products.
<code>zbottom</code>	simple array of doubles	meters	Layer bottom heights above mean sea level. The size of this one-dimensional array corresponds with the number of vertical layers. Only used for three-dimensional products.
<code>LL_lon</code>	double	degrees_east	Longitude of the lower left corner of the lower left pixel
<code>LL_lat</code>	double	degrees_north	Latitude of the lower left corner of the lower left pixel
<code>UL_lon</code>	double	degrees_east	Longitude of the upper left corner of the upper left pixel
<code>UL_lat</code>	double	degrees_north	Latitude of the upper left corner of the upper left pixel
<code>UR_lon</code>	double	degrees_east	Longitude of the upper right corner of the upper right pixel
<code>UR_lat</code>	double	degrees_north	Latitude of the upper right corner of the upper right pixel
<code>LR_lon</code>	double	degrees_east	Longitude of the lower right corner of the lower right pixel
<code>LR_lat</code>	double	degrees_north	Latitude of the lower right corner of the lower right pixel

### 4.3.3 `where` for cross-section data Group

RHI and cross-sections are treated as a special form of cartesian image. The x-dimension of the image represents the coordinate in the x/y-plane, while the y-dimension describes the vertical coordinate of the

RHI or cross-section. To describe the geographical orientation and extend of a RHI or cross-section a dedicated set of `Attributes` in the `where Group` has been defined.

The geographical location of cross-sections is just given by longitudes and latitudes of start and stop positions (Figure 9). The cross-sections are thus assumed to be taken along great-circles. In case they are taken along a line in a plane of a geographical projection, the deviation from the great-circle will be negligible for visualization purposes.

Table 6: `where Attributes` for cross-section data.

Name	Type	Units	Description
Common attributes			
<code>xsize</code>	long	–	Number of pixels in the horizontal dimension
<code>ysize</code>	long	–	Number of pixels in the vertical dimension
<code>xscale</code>	double	meters	Horizontal resolution
<code>yscale</code>	double	meters	Vertical resolution
<code>minheight</code>	double	meters	Minimum height above mean sea level
<code>maxheight</code>	double	meters	Maximum height above mean sea level
RHI specific			
<code>lon</code>	double	degrees_east	Longitude position of the radar antenna. Fractions of a degree are given in decimal notation.
<code>lat</code>	double	degrees_north	Latitude position of the radar antenna. Fractions of a degree are given in decimal notation.
<code>az_angle</code>	double	degrees	Azimuth angle
<code>range</code>	double	meters	Maximum range
Cross section and side panel specific			
<code>start_lon</code>	double	degrees_east	Longitude of the upper left corner of the upper left pixel (start position, Figure 9)
<code>start_lat</code>	double	degrees_north	Latitude of the upper left corner of the upper left pixel (start position, Figure 9)
<code>stop_lon</code>	double	degrees_east	Longitude of the lower right corner of the lower right pixel (stop position, Figure 9)
<code>stop_lat</code>	double	degrees_north	Latitude of the lower right corner of the lower right pixel (stop position, Figure 9)

#### 4.3.4 `where` for vertical profiles

This `where Group` contains mandatory `Attributes` only which collectively describe the geographical and geometrical characteristics of vertical profiles of horizontal winds and/or radar reflectivity.

Table 7: `where Attributes` for vertical profiles.

Name	Type	Units	Description
<code>lon</code>	double	degrees_east	Longitude position of the radar antenna. Fractions of a degree are given in decimal notation.

*continued on next page*

*continued from previous page*

Name	Type	Units	Description
lat	double	degrees_north	Latitude position of the radar antenna. Fractions of a degree are given in decimal notation.
height	double	meters	Height of the centre of the antenna above mean sea level.
levels	long	–	Number of points in the profile
interval	double	meters	Vertical distance between height intervals, or 0.0 if variable
minheight	double	meters	Minimum height above mean sea level
maxheight	double	meters	Maximum height above mean sea level

#### 4.4 how Group

This Group contains `Attributes` which provide additional and complimentary information which can be used to describe a given `Dataset` object, for example information related to an object’s quality. `Attributes` in `how` can be added, but they won’t officially constitute the OPERA standard until they are added to the tables in this information model. **Note** that the placement of the `how` Group may be either at the top level of a given file, or at a lower level associated with a given `Dataset`. If `how` is found at the top level, then it is assumed that its contents apply to all `Datasets` in the file. If `how` is found at a lower level, then it must be located in the `Dataset` Group to which its contents apply. If `how` exists at both the top and lower levels, then the contents of the local `how` override the contents of the top level `how`.

**Note** that user-definable subgroups (including sub-subgroups) may be added to existing `how` Groups, e.g. `how/rsp` (radar signal processor parameters), `how/radar_parameters` (general radar system parameters), `how/bite` (BITE information), `how/monitoring` (external monitoring information), `how/scheduling` (additional scheduling information), `how/radar_processing_chain` (processing chain), `how/product_parameters` (product parameters), and `how/noden`, where  $n$  is the index of a radar node included in a composite. User-definable `Attributes` may be added to these subgroups as long as they do not conflict with each other or with existing `Attributes`.

**Note** as well that there can often be cases where some `Attributes` apply for all `Datasets` in a file and others may be different for each `Dataset`. In such cases, the `Attributes` which apply to all `Datasets` may be held in a top level `how` Group and those that change may be held in local `how` Groups.

For clarity, Table 8 containing mandatory and recommended `how` `Attributes`, respectively, is partitioned such that different partitions contain different product-specific `Attributes`.

Table 8: `how` `Attributes` for all objects. Shading indicates mandatory `Attributes` for single-site data depending on the polarization mode applied and the moments provided (e.g. NI can be omitted if no radial velocity data are available). The non-shaded `Attributes` are optional.

Name	Type	Units	Description
General			
extensions	string	–	Name of the extensions of /what/version
task	string	–	Name of the acquisition task or product generator
task_args	string	–	Task arguments

*continued on next page*

continued from previous page

Name	Type	Units	Description
data_origin	sequence	–	If a quantity or quality field has been modified, the originating quantity or quality field together with the applied quantity or quality field(s) should be provided, e.g. [/datasetM/dataN, /datasetM/dataN/qualityP] or [DBZH, se.smhi.detector.beamblockage].
startepochs	double	seconds since 1970-01-01T 00:00:00Z	Starting time of the data/product. A compliment to “date” and “time” in Table 1, for those who prefer to calculate times directly in epoch seconds.
endepochs	double	seconds since 1970-01-01T 00:00:00Z	Ending time of the data/product. A compliment to “date” and “time” in Table 1, for those who prefer to calculate times directly in epoch seconds.
system	string	–	According to Table 10
TXtype	string	–	Transmitter type [magnetron; klystron; solid state]
poltype	string	–	Polarization type of the radar [single; simultaneous-dual; switched-dual]
polmode	string	–	Current polarity mode [LDR-H; single-H; LDR-V; single-V; simultaneous-dual; switched-dual]
software	string	–	According to Table 11
sw_version	string	–	Software version in string format, e.g. “5.1” or “8.11.6.2”
zr_a	double	–	$Z$ - $R$ constant $a$ in $Z = a R^b$ , applicable to any product containing reflectivity or precipitation data
zr_a_A	simple array of doubles	–	$Z$ - $R$ constant $a$ in $Z = a R^b$ , applicable to any product containing reflectivity or precipitation data. The size of this two-dimensional array corresponds with the values of <code>where/nrays</code> and <code>where/nbins</code> for that dataset.
zr_b	double	–	$Z$ - $R$ exponent $b$ in $Z = a R^b$ , applicable to any product containing reflectivity or precipitation data
zr_b_A	simple array of doubles	–	$Z$ - $R$ exponent $b$ in $Z = a R^b$ , applicable to any product containing reflectivity or precipitation data. The size of this two-dimensional array corresponds with the values of <code>where/nrays</code> and <code>where/nbins</code> for that dataset.
kr_a	double	–	$K_{dp}$ - $R$ constant $a$ in $R = a K_{dp}^b$

continued on next page

continued from previous page

Name	Type	Units	Description
kr_a_A	simple array of doubles	–	$K_{dp}$ - $R$ constant $a$ in $R = a K_{dp}^b$ . The size of this two-dimensional array corresponds with the values of <code>where/nrays</code> and <code>where/nbins</code> for that dataset.
kr_b	double	–	$K_{dp}$ - $R$ exponent $b$ in $R = a K_{dp}^b$
kr_b_A	simple array of doubles	–	$K_{dp}$ - $R$ exponent $b$ in $R = a K_{dp}^b$ . The size of this two-dimensional array corresponds with the values of <code>where/nrays</code> and <code>where/nbins</code> for that dataset.
simulated	boolean	–	“True” if data are simulated, otherwise “False”. <b>Note</b> that this Attribute can be applied to forecasted and backcasted radar quantities as well.
platform_type	string	–	Options are: “fixed”, “vehicle”, “ship”, “aircraft”, “aircraft_fore”, “aircraft_aft”, “aircraft_tail”, “aircraft_belly”, “aircraft_roof”, “aircraft_nose”, “satellite_orbit”, “satellite_geostat”. Assumed “fixed” if missing.
Data from individual radars			
beamwidth	double	degrees	The radar’s half-power beamwidth. Marked for DEPRECATION. To be replaced by <code>how</code> Attributes “beamwH” and “beamwV”.
wavelength	double	cm	Wavelength. Marked for DEPRECATION. To be replaced by <code>how</code> Attribute “frequency”.
frequency	double	Hz	Radar frequency
antspeed	double	degrees/s	Antenna speed (positive for clockwise and ascending, negative for counter-clockwise and descending)
pulsewidth	double	seconds	Pulsewidth
RXbandwidth	double	Hz	Bandwidth that the receiver is set to when operating the radar with the above mentioned pulsewidth
lowprf	double	Hz	Low pulse repetition frequency
midprf	double	Hz	Intermediate pulse repetition frequency
highprf	double	Hz	High pulse repetition frequency
prt	simple array of doubles	seconds	Pulse repetition time. For staggered prt, also see <code>prt_ratio</code> . The size of this one-dimensional array corresponds with the value of <code>where/nrays</code> for that dataset.
prt_ratio	simple array of doubles	–	Ratio of <code>prt/prt2</code> . For dual/staggered prt mode. The size of this one-dimensional array corresponds with the value of <code>where/nrays</code> for that dataset.

continued on next page

*continued from previous page*

Name	Type	Units	Description
TXlossH	double	dB	Total loss in the transmission chain for horizontally-polarized signals, defined as the losses that occur between the calibration reference plane and the feed horn, inclusive
TXlossV	double	dB	Total loss in the transmission chain for vertically-polarized signals, defined as the losses that occur between the calibration reference plane and the feed horn, inclusive
injectlossH	double	dB	Total loss between the calibration reference plane and the test signal generator for horizontally-polarized signals
injectlossV	double	dB	Total loss between the calibration reference plane and the test signal generator for vertically-polarized signals
RXlossH	double	dB	Total loss in the receiving chain for horizontally-polarized signals, defined as the losses that occur between the antenna reference point and the receiver, inclusive.
RXlossV	double	dB	Total loss in the receiving chain for vertically-polarized signals, defined as the losses that occur between the antenna reference point and the receiver, inclusive.
radomelossH	double	dB	One-way dry radome loss for horizontally-polarized signals
radomelossV	double	dB	One-way dry radome loss for vertically-polarized signals
antgainH	double	dB	Antenna gain for horizontally-polarized signals
antgainV	double	dB	Antenna gain for vertically-polarized signals
beamwH	double	degrees	Geometrical horizontal half-power (-3 dB) beamwidth
beamwV	double	degrees	Geometrical vertical half-power (-3 dB) beamwidth
gasattn	double	dB/m	Gaseous specific attenuation assumed by the radar processor (zero if no gaseous attenuation is assumed)
radconstH	double	dB	Radar constant for the horizontal channel. For the precise definition, see Appendix A.
radconstV	double	dB	Radar constant for the vertical channel. For the precise definition, see Appendix A.
nomTXpower	double	dBm	Nominal transmitted peak power at the output of the transmitter (magnetron/klystron output flange)

*continued on next page*



continued from previous page

Name	Type	Units	Description
TXpower	simple array of doubles	dBm	Transmitted peak power at the calibration reference plane. The values given are average powers over all transmitted pulses in each azimuth gate. The size of this one-dimensional array corresponds with the value of <code>where/nrays</code> for that dataset.
powerdiff	double	dB	Power difference between transmitted horizontally and vertically-polarized signals at the the feed horn
phasediff	double	degrees	Phase difference between transmitted horizontally and vertically-polarized signals as determined from the first valid range bins
NI	double	m/s	Unambiguous velocity (Nyquist) interval
Vsamples	long	–	Number of samples used for radial velocity measurements
Polar data			
scan_index	long	–	Which scan this is in the temporal sequence (starting with 1) of the total number of scans comprising the volume.
scan_count	long	–	The total number of scans comprising the volume.
scan_optimized	string	–	Scan optimized for quantity [DBZH; VRADH; etc.]
astart	double	degrees	Azimuthal offset from 0° of the start of the first ray in the sweep. This value is positive where the gate starts clockwise after 0°, and it will be negative if it starts before 0°. In either case, the value must be no larger than half a ray's width.
azmethod	string	–	How raw data in azimuth are processed to arrive at the given value, according to Table 12
elmethod	string	–	How raw data in elevation are processed to arrive at the given value, according to Table 12
binmethod	string	–	How raw data in range are processed to arrive at the given value, according to Table 12
binmethod_avg	long	–	How many original data elements in range are averaged to arrive at the given value
startazA	simple array of doubles	degrees	Azimuthal start angles used for each gate in a scan. The size of this one-dimensional array corresponds with the value of <code>where/nrays</code> for that dataset.

continued on next page

continued from previous page

Name	Type	Units	Description
stopazA	simple array of doubles	degrees	Azimuthal stop angles used for each gate in a scan. The size of this one-dimensional array corresponds with the value of <code>where/nrays</code> for that dataset.
startelA	simple array of doubles	degrees	Elevational start angles used for each gate in a scan. The size of this one-dimensional array corresponds with the value of <code>where/nrays</code> for that dataset.
stopelA	simple array of doubles	degrees	Elevational stop angles used for each gate in a scan. The size of this one-dimensional array corresponds with the value of <code>where/nrays</code> for that dataset.
startT	simple array of doubles	seconds since 1970-01-01T 00:00:00Z	Acquisition start times for each gate in the sector or scan. The size of this one-dimensional array corresponds with the value of <code>where/nrays</code> for that dataset. The required precision is to the millisecond.
stopT	simple array of doubles	seconds since 1970-01-01T 00:00:00Z	Acquisition stop times for each gate in the sector or scan. The size of this one-dimensional array corresponds with the value of <code>where/nrays</code> for that dataset. The required precision is to the millisecond.
Cartesian images including composites			
top_heights	simple array of doubles	meters	Layer top heights above mean sea level. The size of this one-dimensional array corresponds with the number of layers in the product. Marked for DEPRECATION. To be replaced by <code>where Attribute "ztop"</code> .
bottom_heights	simple array of doubles	meters	Layer bottom heights above mean sea level. The size of this one-dimensional array corresponds with the number of layers in the product. Marked for DEPRECATION. To be replaced by <code>where Attribute "zbottom"</code> .
angles	simple array of doubles	degrees	Elevation angles in the order in which they were acquired, used to generate the product. The size of this one-dimensional array corresponds with the number of elevation angles used to generate the product.
arotation	simple array of doubles	degrees/s	Antenna rotation speed (positive for clockwise, negative for counter-clockwise). The size of this one-dimensional array corresponds with the value of <code>how/angles</code> .

continued on next page

*continued from previous page*

Name	Type	Units	Description
camethod	string	–	How Cartesian data are processed, according to Table 12
nodes	sequence	–	Radar nodes (Table 9) which have contributed data to the composite, e.g. “fikor’,’nohur’,’sebaa’,’sehem”
missing_nodes	sequence	–	Radar nodes (Table 9) which have not contributed data to the composite, e.g. “fikor’,’nohur’,’sebaa’,’sehem”. Note, that the sum of radars in <code>how/nodes</code> and <code>missing_nodes</code> shall reflect the total number of radars expected to contribute to the respective composite.
ACCnum	long	–	Number of images used in precipitation accumulation
Vertical profile specific			
minrange	double	meters	Minimum range at which data is used when generating profile
maxrange	double	meters	Maximum range at which data is used when generating profile
sample_size	simple array of longs	–	Number of valid data points in a level of a vertical profile. The size of this one-dimensional array corresponds with the value of <code>where/levels</code> for that dataset.
dealiasd	boolean	–	“True” if data has been dealiasd, “False” if not
vpmethod	string	–	Applied method to derive the vertical profile [VAD; VVP; etc.]
Quality			
pointaccEL	double	degrees	Antenna pointing accuracy in elevation. Possible pointing errors in elevation include e.g. tilt of turning level of the head (tilt of pedestal), non-linearities in gears, backlash in gearboxes, and uncertainties in angle adjustment e.g. using the sun. The value is expected to be in the range $[-90^\circ, 90^\circ]$ . A deviation of $0.0^\circ$ means that the antenna is perfectly aligned.
pointaccAZ	double	degrees	Antenna pointing accuracy in azimuth. Possible pointing errors in azimuth include e.g. non-linearities in gears, backlash in gearboxes, and uncertainties in angle adjustment e.g. using the sun. The value is expected to be in the range $[-180^\circ, 180^\circ]$ . A deviation of $0.0^\circ$ means that the antenna is perfectly aligned.

*continued on next page*

*continued from previous page*

Name	Type	Units	Description
anglesync	string	–	Antenna angle synchronization mode [azimuth; elevation]
anglesyncRes	double	degrees	Resolution of angle synchronization
malfunc	boolean	–	Radar malfunction indicator. If a quantity should not be used for any application due to radar hardware and/or software failure, <code>how/malfunc</code> should be “True”, otherwise “False”.
radar_msg	string	–	Radar malfunction message
radhoriz	double	meters	Radar horizon (maximum range)
NEZH	double	dBZ	The total system noise expressed as the horizontally-polarized reflectivity it would represent at one km distance from the radar
NEZH_A	simple array of doubles	dBZ	The total system noise expressed as the horizontally-polarized reflectivity it would represent at one km distance from the radar. The size of this one-dimensional array corresponds with the value of <code>where/nrays</code> for that dataset.
NEZV	double	dBZ	The total system noise expressed as the vertically-polarized reflectivity it would represent at one km distance from the radar
NEZV_A	simple array of doubles	dBZ	The total system noise expressed as the vertically-polarized reflectivity it would represent at one km distance from the radar. The size of this one-dimensional array corresponds with the value of <code>where/nrays</code> for that dataset.
OUR	double	percent	Overall uptime reliability. Marked for DEPRECATION.
Dclutter	sequence	–	Doppler clutter filters used when collecting data
clutterType	string	–	Description of clutter filter used in the signal processor
clutterMap	string	–	Filename of clutter map
zcalH	double	dB	Calibration offset for the horizontal channel
zcalV	double	dB	Calibration offset for the vertical channel
zdrCAL	double	dB	ZDR calibration offset
nsampleH	double	dBm	Noise sample for the horizontal channel
nsampleH_A	simple array of doubles	dBm	Noise sample for the horizontal channel. The size of this one-dimensional array corresponds with the value of <code>where/nrays</code> for that dataset.
nsampleV	double	dBm	Noise sample for the vertical channel

*continued on next page*

continued from previous page

Name	Type	Units	Description
nsampleV_A	simple array of doubles	dBm	Noise sample for the vertical channel. The size of this one-dimensional array corresponds with the value of where/nrays for that dataset.
comment	string	–	Free text description. Anecdotal quality information.
SQI	double	–	Signal Quality Index threshold value
CSR	double	–	Clutter-to-signal ratio threshold value
LOG	double	dB	Security distance above mean noise level threshold value. Marked for DEPRECATION. To be replaced by how Attribute “LOG_threshold”.
LOG_threshold	double	dB	Security distance above mean noise level, i.e. all data below noise+LOG_threshold are thresholded. It is usually set in the radar software.
VPRCorr	boolean	–	“True” if vertical reflectivity profile correction has been applied, otherwise “False”
melting_layer_top	double	meters	Melting layer top height above mean sea level
melting_layer_top_A	simple array of doubles	meters	Melting layer top height above mean sea level. The size of this two-dimensional array corresponds with the values of where/nrays and where/nbins for that dataset.
melting_layer_bottom	double	meters	Melting layer bottom height above mean sea level
melting_layer_bottom_A	simple array of doubles	meters	Melting layer bottom height above mean sea level. The size of this two-dimensional array corresponds with the values of where/nrays and where/nbins for that dataset.
min	double	–	Minimum value for continuous quality data
max	double	–	Maximum value for continuous quality data
step	double	–	Step value for continuous quality data
levels	long	–	Number of levels in discrete data legend
peakpwr	double	dBm	Peak power
avgpwr	double	dBm	Average power
dynrange	double	dB	Dynamic range
RAC	double	dB	Range attenuation correction
BBC	boolean	–	“True” if bright-band correction applied, otherwise “False”
PAC	double	dB	Precipitation attenuation correction

continued on next page

continued from previous page

Name	Type	Units	Description
SNRT	double	dB	Signal-to-noise ratio threshold. Marked for DEPRECATION. To be replaced by how Attribute "SNR_threshold".
SNR_threshold	double	dB	Signal-to-noise ratio threshold
SNRHCT	double	dB	Signal-to-noise ratio co-polar H threshold. Marked for DEPRECATION. To be replaced by how Attribute "SNRHC_threshold".
SNRHC_threshold	double	dB	Signal-to-noise ratio co-polar H threshold. This attribute should be used for a STAR (simultaneous transmit and receive) mode radar.
SNRHXT	double	dB	Signal-to-noise ratio cross-polar H threshold. Marked for DEPRECATION. To be replaced by how Attribute "SNRHX_threshold".
SNRHX_threshold	double	dB	Signal-to-noise ratio cross-polar H threshold
SNRVCT	double	dB	Signal-to-noise ratio co-polar V threshold. Marked for DEPRECATION. To be replaced by how Attribute "SNRVC_threshold".
SNRVC_threshold	double	dB	Signal-to-noise ratio co-polar V threshold. This attribute should be used for a STAR mode radar.
SNRVXT	double	dB	Signal to noise ratio cross-polar V threshold. Marked for DEPRECATION. To be replaced by how Attribute "SNRVX_threshold".
SNRVX_threshold	double	dB	Signal to noise ratio cross-polar V threshold
polarization	string	–	Type of polarization (H, V) transmitted by the radar
MDS	double	dBm	Minimum detectable signal at the antenna feed
base_1km_hc	double	dBZ	Reflectivity at 1 km for SNR = 0 dB noise-corrected H co-polar channel
base_1km_vc	double	dBZ	Reflectivity at 1 km for SNR = 0 dB noise-corrected V co-polar channel
smoothed_PHIDP	boolean	–	"True" if PHIDP or UPHIDP has been smoothed, "False" if not
altitude_agl	double	meters	Altitude of the center of rotation of the antenna above ground level.
metadata_changed	sequence	–	Metadata which have been changed afterwards, e.g. "'beamwH','gasattn'".

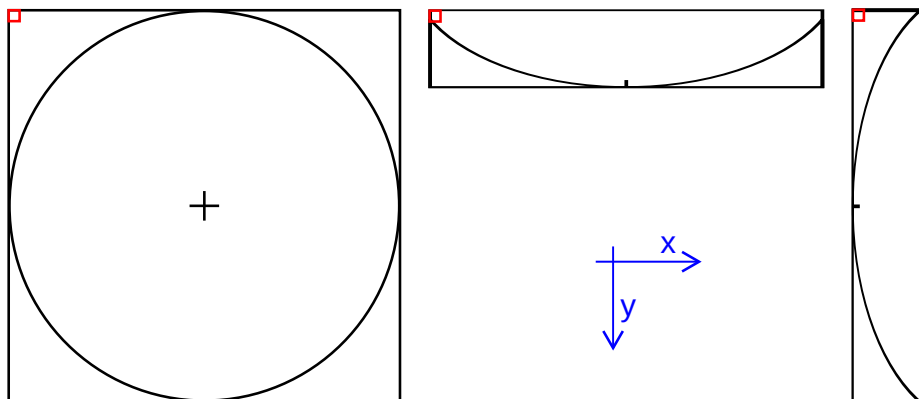

Figure 9: Cartesian MAX product with horizontal (HSP) and vertical side panels (VSP). The red boxes indicate the start position for each panel.

Table 9: Examples of radar “places” and their node designations. The first two letters in the “node” represent the country, following the Internet convention. The “place” name may use ASCII representations of UTF-8<sup>5</sup>. The “node” must only use ASCII. Radars not in this table can be added.

Place	Node
Hasvik	nohas
Andøya	noand
Røst	norst
Rissa	norsa
Bømlo	nobml
Hægebostad	nohgb
Oslo	noosl
Kiruna	sekrn
Luleå	sella
Örnsköldsvik	seoer
Östersund	seosd
Hudiksvall	sehuv
Leksand	selek
Bålsta	sebaa
Åtvidaberg	seatv
Vara	sevox
Hemse	sehem
Karlskrona	sekaa
Ängelholm	seang
Korpo	fikor
Vantaa	fivan
Anjalankoski	fianj
Ikaalinen	fiika
Kuopio	fikuo
Vimpeli	fivim

*continued on next page*

*continued from previous page*

Place	Node
Utajärvi	fiuta
Luosto	filuo
Bornholm	dkbor
Stevns	dkste
Sindal	dksin
Rømø	dkrom
De Bilt	nldbl
Den Helder	nldhl
Tallinn	eetal
Sürgavere	eesur
Riga	lvrix
Legionowo	plleg
Poznan	plpoz
Gdansk	plgda
Swidwin	plswi
Rzeszow	plrze
Brzuchania	plbrz
Ramza	plram
Pastewnik	plpas

Table 10: Radar system abbreviations and their meanings (“xxx” is a placeholder for the model/abbreviation used by the manufacturer, e.g. DWSR-2501C-SDP). Radar systems not in this table can be added.

String	Meaning
GEMAxXX	Gematronik Meteor ACxxx Radar
EECxXX	EEC xxx Radar
ERICxxx	Ericsson xxx Radar
VAISxxx	Vaisala xxx Radar

Table 11: Processing Software abbreviations and their meanings. Systems not in this table can be added.

String	Meaning
BALTRAD	BALTRAD toolbox
CASTOR	Météo France’s system
SERVAL	Météo France’s system
EDGE	EEC Edge
FROG	Gamic FROG, MURAN ...
IRIS	Vaisala Sigmat IRIS
METEOCELL	IRAM’s system
NORDRAD	NORDRAD
RADARNET	UKMO’s centralised processing system

*continued on next page*

<sup>5</sup>For example, the character ñ (UNICODE character U+00F1) is represented in binary UTF-8 as \xf1 whereas its ASCII representation is \xc3\xb1.



continued from previous page

String	Meaning
CYCLOPS	UKMO's site processing system
RAINBOW	Selex Gematronik Rainbow
POLARA	DWD-Polarimetric-Radar SW-Suite

Table 12: Method abbreviations and their meanings.

String	Meaning
NEAREST	Nearest neighbour or closest radar
INTERPOL	Interpolation
AVERAGE	Average of all values
QAVERAGE	Quality-weighted average
RANDOM	Random
MDE	Minimum distance to earth
LATEST	Most recent radar
MAXIMUM	Maximum value
QMAXIMUM	Maximum quality
DOMAIN	User-defined compositing
VAD	Velocity azimuth display
VVP	Volume velocity processing
RGA	Gauge-adjustment

#### 4.5 what Group for Dataset objects

In this section the content of the what Group to be used with each Dataset is described. **Note** that the linear transformation coefficients “gain” and “offset” in

$$\text{quantity\_value} = \text{offset} + \text{gain} \times \text{raw\_value}$$

should be set to 1.0 and 0.0 respectively if they are not intended for use with a given Dataset. **Note** that **dataset-specific** what header Attributes should be placed in /datasetX/dataY/what (Table 13).

Table 13: Dataset-specific what header Attributes.

Name	Type	Format	Location	Description
product	string	–	/datasetX/what	According to Table 14
prodname	string	–	/datasetX/what	Product name. Only used for non-polar products.
prodpar	string	–	/datasetX/what	According to Table 15. Only used for non-polar products.
startdate	string	YYYYMMDD	/datasetX/what	Starting Year, Month, and Day for the product
starttime	string	HHmmss	/datasetX/what	Starting Hour, Minute, and Second for the product

continued on next page

continued from previous page

Name	Type	Format	Location	Description
enddate	string	YYYYMMDD	/datasetX/what	Ending Year, Month, and Day for the product
endtime	string	HHmmss	/datasetX/what	Ending Hour, Minute, and Second for the product
quantity gain	string	–	/datasetX/dataY/what	According to Table 16
	double	–	/datasetX/dataY/what	Coefficient in quantity_value = offset + gain × raw_value used to convert to physical unit. Default value is 1.0.
offset	double	–	/datasetX/dataY/what	Coefficient in quantity_value = offset + gain × raw_value used to convert to physical unit. Default value is 0.0.
nodata	double	–	/datasetX/dataY/what	Raw value used to denote areas void of data (never radiated). <b>Note</b> that this Attribute is always a float even if the data in question is in another format.
undetected	double	–	/datasetX/dataY/what	Raw value used to denote areas below the measurement detection threshold (radiated but nothing detected). <b>Note</b> that this Attribute is always a float even if the data in question is in another format.

Table 14: Product abbreviations and their meanings.

String	Meaning
SCAN	A scan of polar data
PPI	Plan position indicator (cartesian)
CAPPI	Constant altitude PPI
PCAPPI	Pseudo-CAPPI
ETOP	Echo top
EBASE	Echo base
MAX	Maximum
RR	Accumulation
VIL	Vertically integrated liquid water
SURF	Information valid at the Earth’s surface
COMP	Composite
VP	Vertical profile
RHI	Range height indicator

continued on next page

continued from previous page

String	Meaning
XSEC	Arbitrary vertical slice
VSP	Vertical side panel
HSP	Horizontal side panel
RAY	Ray
AZIM	Azimuthal type product
QUAL	Quality metric

Table 15: Product parameters.

Product	Type	Units	Product parameter
CAPPI	double	meters	Layer height above the radar
PCAPPI	double	meters	Layer height above the radar
PPI	double	degrees	Elevation angle used
ETOP	double	dBZ	Reflectivity level threshold
EBASE	double	dBZ	Reflectivity level threshold
RHI	double	degrees	Azimuth angle
VIL	simple array of doubles	meters	Bottom and top heights of the integration layer

Table 16: Quantity (variable) identifiers. Radar moments are those received by the radar or derived thereof.

String	Units	Description
TH	dBZ	Logged horizontally-polarized total (uncorrected) reflectivity factor
TV	dBZ	Logged vertically-polarized total (uncorrected) reflectivity factor
DBZH	dBZ	Logged horizontally-polarized (corrected) reflectivity factor
DBZV	dBZ	Logged vertically-polarized (corrected) reflectivity factor
ZDR	dB	Logged differential reflectivity
UZDR	dB	Logged differential reflectivity that has not been subject to a Doppler filter
RHOHV	–	Correlation coefficient between $Z_h$ and $Z_v$ . The values are expected to be in the range [0, 1].
URHOHV	–	Correlation coefficient between $Z_h$ and $Z_v$ that has not been subject to any filter or correction. The values are expected to be in the range [0, 1].
LDR	dB	Linear depolarization ratio
ULDR	dB	Linear depolarization ratio that has not been subject to a Doppler filter
PHIDP	degrees	Differential phase
UPHIDP	degrees	Differential phase that has not been subject to any filter or correction
PIA	dB	Path Integrated Attenuation
KDP	degrees/km	Specific differential phase

continued on next page

*continued from previous page*

String	Units	Description
UKDP	degrees/km	Specific differential phase that has not been subject to any filter or correction
SQIH	–	Signal quality index - horizontally-polarized. The values are expected to be in the range [0, 1].
USQIH	–	Signal quality index - horizontally-polarized - that has not been subject to a Doppler filter. The values are expected to be in the range [0, 1].
SQIV	–	Signal quality index - vertically-polarized. The values are expected to be in the range [0, 1].
USQIV	–	Signal quality index - vertically-polarized - that has not been subject to a Doppler filter. The values are expected to be in the range [0, 1].
SNR	dB	Signal-to-noise ratio
SNRHC	dB	Signal-to-noise ratio co-polar H. This attribute should be used for a STAR mode radar.
SNRHX	dB	Signal-to-noise ratio cross-polar H
SNRVC	dB	Signal-to-noise ratio co-polar V. This attribute should be used for a STAR mode radar.
SNRVX	dB	Signal to noise ratio cross-polar V
USNRHC	dB	Signal-to-noise ratio co-polar H that has not been subject to a Doppler filter. This attribute should be used for a STAR mode radar.
USNRVC	dB	Signal-to-noise ratio co-polar V that has not been subject to a Doppler filter. This attribute should be used for a STAR mode radar.
CCORH	dB	Clutter correction - horizontally-polarized
CCORV	dB	Clutter correction - vertically-polarized
CPA	–	Clutter phase alignment. The values are expected to be in the range [0, 1] (0: low probability of clutter, 1: high probability of clutter).
RATE	mm/h	Rain rate
URATE	mm/h	Uncorrected rain rate
POR	–	Probability of rain. The values are expected to be in the range [0, 1] (0: low probability, 1: high probability).
HI	dBZ	Hail intensity
POH	–	Probability of hail. The values are expected to be in the range [0, 1] (0: low probability, 1: high probability).
POSH	–	Probability of severe hail. The values are expected to be in the range [0, 1] (0: low probability, 1: high probability).
MESH	mm	Maximum expected severe hail size
ACRR	mm	Accumulated precipitation
HGHT	meters	Height above mean sea level
VIL	kg/m <sup>2</sup>	Vertical Integrated Liquid water
VRADH	m/s	Radial velocity - horizontally-polarized. Radial winds towards the radar are negative, while radial winds away from the radar are positive (PANT).

*continued on next page*

continued from previous page

String	Units	Description
UVRADH	m/s	Radial velocity - horizontally-polarized - that has not been subject to any filter or correction. Radial winds towards the radar are negative, while radial winds away from the radar are positive (PANT).
VRADV	m/s	Radial velocity - vertically-polarized. Radial winds towards the radar are negative, while radial winds away from the radar are positive (PANT).
UVRADV	m/s	Radial velocity - vertically-polarized - that has not been subject to any filter or correction. Radial winds towards the radar are negative, while radial winds away from the radar are positive (PANT).
VRADDH	m/s	Dealiased horizontally-polarized radial velocity
VRADDV	m/s	Dealiased vertically-polarized radial velocity
WRADH	m/s	Spectral width of radial velocity - horizontally-polarized
UWRADH	m/s	Spectral width of radial velocity - horizontally-polarized - that has not been subject to any filter or correction
WRADV	m/s	Spectral width of radial velocity - vertically-polarized
UWRADV	m/s	Spectral width of radial velocity - vertically-polarized - that has not been subject to any filter or correction
UWND	m/s	Component of wind in x-direction
VWND	m/s	Component of wind in y-direction
RSHR	m/s km	Radial shear
ASHR	m/s km	Azimuthal shear
CSHR	m/s km	Range-azimuthal shear
ESHR	m/s km	Elevation shear
OSHR	m/s km	Range-elevation shear
HSHR	m/s km	Horizontal shear
VSHR	m/s km	Vertical shear
TSHR	m/s km	Three-dimensional shear
PSPH	dBm	Power spectrum peak - horizontally-polarized
PSPV	dBm	Power spectrum peak - vertically-polarized
UPSPH	dBm	Power spectrum peak - horizontally-polarized - that has not been subject to any filter or correction
UPSPV	dBm	Power spectrum peak - vertically-polarized - that has not been subject to any filter or correction
BRDR	-	1 denotes a border where data from two or more radars meet in composites, otherwise 0
QIND	-	Spatially analyzed quality indicator, according to OPERA II, normalized to between 0 (poorest quality) to 1 (best quality)
CLASS	-	Indicates that data are classified and that the classes are specified according to the associated legend object (Section 6.2) which must be present.
Vertical profile specific		
ff	m/s	Mean horizontal wind velocity
dd	degrees	Mean horizontal wind direction
ff_dev	m/s	Velocity variability

continued on next page

*continued from previous page*

String	Units	Description
dd_dev	m/s	Direction variability
DBZH_dev	dBZ	Variability of the logged horizontally-polarized (corrected) reflectivity factor
DBZV_dev	dBZ	Variability of the logged vertically-polarized (corrected) reflectivity factor
w	m/s	Vertical velocity (positive upwards)
w_dev	m/s	Vertical velocity variability
div	$s^{-1}$	Divergence
div_dev	$s^{-1}$	Divergence variability
def	$s^{-1}$	Deformation
def_dev	$s^{-1}$	Deformation variability
ad	degrees	Axis of dilation. The values are expected to be in the range $[0^\circ, 360^\circ)$ .
ad_dev	degrees	Variability of the axis of dilation. The values are expected to be in the range $[0^\circ, 360^\circ)$ .
rhohv_dev	–	Variability of the correlation coefficient. The values are expected to be in the range $[0, 1]$ .

## 5 Data specification

All data arrays, for polar, cartesian, and profile data, are stored as **dataset** objects. Any of the types/depths stated in Sec. 3.3 are allowed. Any of compression levels 1 to 6 are recommended. (HDF5’s built-in compression levels range from 0 (none) to 9 (maximum); levels above 6 tend to result in the algorithm using disproportionate resources relative to gains in file size, which is why their use is not encouraged.) HDF5 provides support for SZIP compression in addition to default ZLIB compression, but SZIP compression library is proprietary and will therefore not be supported in any official OPERA software.

All Dataset Groups are called `datasetn`, no matter which kind of data they hold. The character `n` represents the index of the Dataset Group in acquisition order in terms of elevation angle (polar data), and ascending order in terms of height (Cartesian products) starting at 1. A Dataset Group can hold an arbitrary number of binary **datasets**. In the case of radar parameters (e.g. Z, V, W, etc.) the **datasets** containing each parameter are each contained in a Group called `datan`, where `n` is the index of the **dataset** holding the binary data. This **dataset** is simply called `data`.

Within each `datan` Group, there may be an arbitrary number of quality indicators, each of which is held in a Group called `qualityn`, where `n` is the index of the **dataset** (in application order in terms of quality indicator) holding the binary data. This **dataset** is simply called `data`. Because the quality indicator(s) describe a given quantity, they need not be assigned values of “nodata and” “undetected”, as this information is already contained in the quantity being described. However, if one wishes to represent a quality indicator or index as a stand-alone product, then this should be done by representing it in its own **dataset** and assigning it the QIND quantity according to Table 16.

Each Dataset Group can store local `what`, `where` and `how` Groups to store metadata which are unique to that Dataset.

**Note** that data with 8-bit unsigned depth (`uchar`) can be represented as an HDF5 Image (H5IM) (Table 17). This applies to any 2-D Dataset, be it polar, Cartesian, sector, or cross-section. This is a Dataset with a few added `Attributes` which facilitate the Image’s management by third-party software<sup>5</sup>.

Table 17: Mandatory 8-bit Image attributes. **Note** that these are part of a Dataset object.

Attribute	Type	Description
CLASS	string	Should be “IMAGE”
IMAGE_VERSION	string	Should be “1.2”, the current version number

There are several optional `Attributes` describing an HDF5 Image, including Palette information (see Section 6.1).

A schematic of this organization is found in Section 2. What follows is details pertaining to each type of data that may be represented as binary data.

<sup>5</sup><https://portal.hdfgroup.org/display/HDF5/HDF5+Image+and+Palette+Specification%2C+Version+1.2>

## 5.1 Polar Data

If possible, the start of the first azimuth gate (the first pulse) always points due north and the first range bin is that starting at the radar. This azimuthal precision may not be achievable in practice, in which case the first azimuth gate is the one in the sweep with a starting azimuthal angle closest to  $0^\circ$ . This applies to data representing a full sweep, but not sector scans. For full sweeps, this implies that the first azimuth gate covers the interval  $0-1^\circ$  assuming 360 azimuth gates per scan. Azimuth gates are ordered clockwise except for sector scans which can be clockwise or counter-clockwise. In other words, range bins are stored in the array's equivalent X-dimension and azimuth gates in the Y-dimension. There is no mechanism for specifying missing azimuth gates or range bins in SCAN objects. This means that partial scans/rays must be filled-in in order to complete them. Filled-in areas are identified by the "nodata" value specified in the corresponding `what` Group. Radiated areas with no echo are represented with the "undetected" value also in the corresponding `what` Group. Alternatively, collections of rays can be stored in the RAY object, and sectors can be stored in the AZIM object. The first azimuth gate in the scan does not have to be the first ray of data collected for that scan, but the `/datasetn/where/algate` Attribute contains the information on this, thereby allowing a temporal reconstruction of the data collection.

All full-sweep data must be sorted according to the above description: clockwise and starting from north, even if they haven't been acquired that way. Azimuthal overlap is not allowed. Rays whose starting azimuthal angle go beyond  $360^\circ$  from `algate`, ie. start a second sweep or replicate previous rays, must be omitted. It is therefore the responsibility of each supplier to comply with this specification.

All parameters collected in a single scan of data are contained in one `Dataset` Group with the same index number, as separate data `Dataset` Groups.

## 5.2 Image Data

An image product in this context refers to 2-D cartesian quantitative data and not a visual graphic product (PIC, see Section 5.6 below).

Binary arrays are stored as one long unpadded binary string starting in the upper-left corner and proceeding row by row (north to south), from left (west) to right (east). Areas void of the specified variable are flagged using the "nodata" value specified in the corresponding `what` Group. Radiated areas with no echo are represented with the "undetected" value also in the corresponding `what` Group.

## 5.3 RHIs, cross sections and side panels

RHI, cross sections and side panels are a special form of image. RHIs taken with the antenna pointing east start on the left and end on the right. If the antenna points west, then the RHI starts on the right and ends on the left. RHIs pointing exactly south or north always start on the left and end on the right. For cross sections, the left side of the image is the starting point and the right side is the finishing point, regardless of the antenna's azimuth angle. For side panels, the starting point is north for vertical panels and west for horizontal panels. As with other image files, the first pixel is the upper-left one and image content is ordered row-wise from top to bottom and left to right.



## 5.4 Profiles

In contrast to polar or cartesian data which use `Datasets` to store 2-D arrays, profiles use several `Datasets` to store 1-D arrays representing different variables along a given profile. One variable is stored in each `Dataset`. Levels in the profile are ordered sequentially in ascending order. A profile is a `Group` containing several `Datasets`, each of which stores a variable for that level. This profile formulation is not restricted to wind variables, but can easily accommodate reflectivity and other variables as well.

Each `Dataset` containing a parameter making up the the profile contains a quantity designator according to Table 16.

**Note** that all **datasets** must be of equal length, in order to match the heights given in the **dataset** containing the quantity HGHT.

## 5.5 Rays and sectors

It is unlikely that individual rays or sectors of data will be exchanged operationally and internationally, but these objects are added for the sake of completeness and in cases where quality information can be efficiently represented using these objects. Also, there may be production chains where the radar transmits each ray individually, so the availability of this means of representation can support them.

An individual ray of data is stored as a **dataset** with the most proximate data first. Missing data along the ray must be assigned the “nodata” and/or “undetected” values.

A sector is similar to a scan with the difference being that the sector doesn’t cover the horizon completely. A sector is stored the same way as a scan, the only clarification being the object name (Table 2 or 14) and the metadata in Table 4.

Alternatively, sectors can be represented as a collection of rays. This might be handy if the rays are few and with variable starting and ending rays, and/or with different range bin spacing from one ray to the next.

## 5.6 Embedded graphical images

Image files in industrial graphics formats, e.g. PNG, JPEG, GIF, TIFF, etc., can be written directly into a **dataset** as is. When this file is then retrieved, all that is necessary is to read the **dataset** contents as is and write a new file containing them.

## 6 Optional objects

There are two kind of objects which may be included in the HDF5 files and which are considered optional in this information model. These are palettes which may be attached to a given **dataset** to “color” them intuitively, and discrete legends which may complement a given **dataset** with what can be considered quality-related information. Each of these objects is specified below.

### 6.1 Palettes

The HDF5 Image API contains functionality for associating palettes (or color tables) with 8-bit and 24-bit arrays. Since we have not defined 24-bit graphic images explicitly in this information model, the treatment of palettes will be limited to 8-bit **datasets**. Most radar data exchanged in Europe today is 8-bit, so the ability to complement them with palettes can be considered an enhancement. This is particularly interesting since the standard HDF5 binary tool *h52gif* converts an 8-bit **dataset** to a GIF file with or without an associated palette. And the *hdfview* tool visualizes the data with the palette if one is available. The reader is referred to the HDF5 documentation for complete information.

In order for an 8-bit `Dataset` to work with a palette, it must be defined as an `Image`. This is done by adding a few attributes to the `Dataset`, and this process does not impact at all on the binary array data. In other words, applications that only read the data won't be affected. This means that those applications that wish to use the palette can do so and those that don't can do so without having to modify any routines. The palette is defined as a separate `Dataset` and then the palette is linked to the binary array `Dataset`. This does not affect the binary data either. The result is a straight-forward and unobtrusive mechanism for adding color to data.

An example of how a palette complements an 8-bit dataset is given in Table 20.

### 6.2 Legends

The HDF5 library enables users to define and store so-called “compound” data type objects. Compound data type objects are heterogeneous elements - a multi-dimensional array of fields. Such arrays consist of fields that either represent atomic data types defined in the HDF5 API, or compound data types. In the latter case such construction is referred to as “nested compound type”. The reader is referred to the HDF5 documentation for complete information; what follows here is summarized.

Compound data type objects are handled by the HDF5 library which provides functions for reading and writing data to and from a **dataset** of a compound type. With these functions, either the whole record (an instance of compound data type) can be read or written or particular fields can be accessed in both read and write mode.

The compound data type is designed for use mainly in C language applications. This is a direct consequence of the approach to memory organization and access, which is based on C structures. However, it is still possible to use compound data types in Java applications, as well as to map compound data types to XML node structures.

The compound data type is suitable for holding and processing legend data relating to discrete quality information. In most cases, such a legend would contain two elements: *key* and *value*. *Key* is an abbreviated

character code for a given level of quality parameter it describes. *Value* holds the actual parameter value in the form of a character string. This pair of fields can be represented by the following C structure:

```
struct legend
{
    char[] key;
    char[] value;
};
```

The structure describes a given discrete quality parameter which, for example, can be a data quality indicator depending on distance to the radar. Such quality indicator can be stratified into several discrete categories, represented by character strings of a given constant length. Another example is a hydrometeor classification based on polarimetric variables (Table 18). In both case, the key field of the legend structure will hold the category string, while the corresponding value will be stored in value field, which is also an array of characters. The length of particular fields can be either given explicitly (e.g. described in dedicated quality parameters table) or can be determined at runtime.

Table 18: Example for a hydrometeor classification legend.

Value	Key
0	NONE
1	GROUNDCLUTTER
2	SEACLUTTER
3	BIOLOGICAL
4	DRYSNOW
5	WETSNOW
6	ICECRYSTALS
7	GRAUPEL
8	BIGDROPS
9	RAIN
10	HEAVYRAIN
11	RAINHAIL
12	CHAFF

Since HDF5 approaches data object in the way the C language does, it is crucial to meet C standards while designing and processing compound data structures. Because C does not support string objects (strings of characters of variable length), the string object can only be represented by an array of characters. In addition, to provide the possibility to determine the length of a legend dataset at runtime, an instance of a legend structure object should have fixed and constant byte length. This can be achieved by using character arrays of constant length. For the purpose of legend dataset, it seems reasonable to use 64-byte array for the key field, and 32-byte array for value field. The space used by the actual content of each legend structure depends on the user. The only requirement is that character is null terminated (the last character in array is null character).

```
struct legend
{
    char[64] key;
    char[32] value;
};
```

Once the legend structure is defined, instances of the legend structure are stored in a dedicated **dataset**. When defining a **dataset** data type, `H5T_COMPOUND` type must be used.

## Endnote on software compatibility and versions

The use of the netCDF file format has also gained momentum within the meteorological and climatological communities. Today netCDF is a high-level layer built upon HDF5. Starting with HDF5 version 1.8.0 and netCDF version 4, HDF5 is able to manage netCDF files. There are also Java tools with netCDF which enable reading and writing of some kinds of HDF5 files. Since we recognize the benefits of being able to manage HDF5 files with netCDF (and vice versa), we require that any implementation of the information model specified in this document must use HDF5 version 1.8.0 or later. By organizing data in HDF5 in the straight-forward way specified in this document, the simplicity should facilitate for netCDF to manage such attributes and datasets.

## 7 Mandatory metadata per product

The purpose of this section is to clarify exactly which metadata attributes are mandatory for each type of product. So far, we have only mentioned that `what` and `where` Groups are mandatory, whereas `how` is partly mandatory. Here, we are specific about which metadata **must always** be present for each kind of product. In order for this to be a reasonable level of ambition, only those metadata which are fundamentally necessary to be able to manage the product at all, ie. at a purely functional level, are mandatory.

When it comes to optional `how` attributes, we don't forget that these attributes are recommended and should be included if they are available. In the presentations that follow, the recommended locations of the mandatory `how` attributes are included.

The method used to present the metadata is in the form of terse listings, using the file-system analogy shown in Section 2 on page 2. The exact format of each node in the HDF5 file is according to the tables referred to in this document.

Datasets are also included in the following tables, for clarity.

### 7.1 Polar volume

The following example represents a polar volume consisting of two scans, each of which contains two parameters. The polar geometry is the same in both scans, the only differences being the elevation angle and the first measured azimuth gate in each scan. Using different pulsewidths and/or antenna rotation speeds between scans would necessitate placing the `how` attributes in their respective **datasets** instead of at the top level.

Table 19: Polar volume.

Node	Type
/	Root Group
/Conventions	Attribute, Section 4.1
/what	Group
/what/object	Attribute, Table 2
/what/version	Attribute, Table 1
/what/date	Attribute, Table 1
/what/time	Attribute, Table 1
/what/source	Attribute, Table 3
/where	Group
/where/lon	Attribute, Table 4
/where/lat	Attribute, Table 4
/where/height	Attribute, Table 4
/how	Group
/how/antgainH	Attribute, Table 8
/how/antgainV	Attribute, Table 8
/how/beamwH	Attribute, Table 8
/how/beamwV	Attribute, Table 8
/how/frequency	Attribute, Table 8

*continued on next page*

*continued from previous page*

Attribute name	Type
/how/NI	Attribute, Table 8
/how/radconstH	Attribute, Table 8
/how/radconstV	Attribute, Table 8
/how/simulated	Attribute, Table 8
/how/pulsewidth	Attribute, Table 8
/how/RXlossH	Attribute, Table 8
/how/RXlossV	Attribute, Table 8
/how/scan_count	Attribute, Table 8
/dataset1	Group
/dataset1/what	Group
/dataset1/what/product	Attribute, Table 14
/dataset1/what/startdate	Attribute, Table 13
/dataset1/what/starttime	Attribute, Table 13
/dataset1/what/enddate	Attribute, Table 13
/dataset1/what/endtime	Attribute, Table 13
/dataset1/where	Group
/dataset1/where/elangle	Attribute, Table 4
/dataset1/where/agate	Attribute, Table 4
/dataset1/where/nbins	Attribute, Table 4
/dataset1/where/rstart	Attribute, Table 4
/dataset1/where/rscale	Attribute, Table 4
/dataset1/where/nrays	Attribute, Table 4
/dataset1/how	Group
/dataset1/how/scan_index	Attribute, Table 8
/dataset1/how/startazA	Attribute, Table 8
/dataset1/how/stopazA	Attribute, Table 8
/dataset1/data1	Group
/dataset1/data1/what	Group
/dataset1/data1/what/quantity	Attribute, Table 16
/dataset1/data1/what/gain	Attribute, Table 13
/dataset1/data1/what/offset	Attribute, Table 13
/dataset1/data1/what/nodata	Attribute, Table 13
/dataset1/data1/what/undetected	Attribute, Table 13
/dataset1/data1/data	Dataset
/dataset1/data1/data/CLASS	Attribute, Table 17
/dataset1/data1/data/IMAGE_VERSION	Attribute, Table 17
/dataset1/data2	Group
/dataset1/data2/what	Group
/dataset1/data2/what/quantity	Attribute, Table 16
/dataset1/data2/what/gain	Attribute, Table 13
/dataset1/data2/what/offset	Attribute, Table 13
/dataset1/data2/what/nodata	Attribute, Table 13
/dataset1/data2/what/undetected	Attribute, Table 13
/dataset1/data2/data	Dataset
/dataset1/data2/data/CLASS	Attribute, Table 17

*continued on next page*

*continued from previous page*

Attribute name	Type
/dataset1/data2/data/IMAGE_VERSION	Attribute, Table 17
/dataset2	Group
/dataset2/what	Group
/dataset2/what/product	Attribute, Table 14
/dataset2/what/startdate	Attribute, Table 13
/dataset2/what/starttime	Attribute, Table 13
/dataset2/what/enddate	Attribute, Table 13
/dataset2/what/endtime	Attribute, Table 13
/dataset2/where	Group
/dataset2/where/elangle	Attribute, Table 4
/dataset2/where/algate	Attribute, Table 4
/dataset2/where/nbins	Attribute, Table 4
/dataset2/where/rstart	Attribute, Table 4
/dataset2/where/rscale	Attribute, Table 4
/dataset2/where/nrays	Attribute, Table 4
/dataset2/how	Group
/dataset2/how/scan_index	Attribute, Table 8
/dataset2/how/startazA	Attribute, Table 8
/dataset2/how/stopazA	Attribute, Table 8
/dataset2/data1	Group
/dataset2/data1/what	Group
/dataset2/data1/what/quantity	Attribute, Table 16
/dataset2/data1/what/gain	Attribute, Table 13
/dataset2/data1/what/offset	Attribute, Table 13
/dataset2/data1/what/nodata	Attribute, Table 13
/dataset2/data1/what/undetected	Attribute, Table 13
/dataset2/data1/data	Dataset
/dataset2/data1/data/CLASS	Attribute, Table 17
/dataset2/data1/data/IMAGE_VERSION	Attribute, Table 17
/dataset2/data2	Group
/dataset2/data2/what	Group
/dataset2/data2/what/quantity	Attribute, Table 16
/dataset2/data2/what/gain	Attribute, Table 13
/dataset2/data2/what/offset	Attribute, Table 13
/dataset2/data2/what/nodata	Attribute, Table 13
/dataset2/data2/what/undetected	Attribute, Table 13
/dataset2/data2/data	Dataset
/dataset2/data2/data/CLASS	Attribute, Table 17
/dataset2/data2/data/IMAGE_VERSION	Attribute, Table 17

## 7.2 Composite

The following example shows how a composite image is represented. It also contains the standard HDF5 mechanisms for including a palette, assuming the image payload is 8-bit, along with a quality indicator field

describing the given composite product. The COMP object can use /dataset1/data1/what/quantity, if the object contains more than one parameter/quantity.

Table 20: Cartesian image with palette.

Attribute name	Type
/	Root Group
/Conventions	Attribute, Section 4.1
/what	Group
/what/object	Attribute, Table 2
/what/version	Attribute, Table 1
/what/date	Attribute, Table 1
/what/time	Attribute, Table 1
/what/source	Attribute, Table 3
/where	Group
/where/projdef	Attribute, Table 5
/where/xsize	Attribute, Table 5
/where/ysize	Attribute, Table 5
/where/xscale	Attribute, Table 5
/where/yscale	Attribute, Table 5
/where/LL_lon	Attribute, Table 5
/where/LL_lat	Attribute, Table 5
/where/UL_lon	Attribute, Table 5
/where/UL_lat	Attribute, Table 5
/where/UR_lon	Attribute, Table 5
/where/UR_lat	Attribute, Table 5
/where/LR_lon	Attribute, Table 5
/where/LR_lat	Attribute, Table 5
/dataset1	Group
/dataset1/what	Group
/dataset1/what/product	Attribute, Table 14
/dataset1/what/prodname	Attribute, Table 13
/dataset1/what/prodpar	Attribute, Table 15
/dataset1/what/startdate	Attribute, Table 13
/dataset1/what/starttime	Attribute, Table 13
/dataset1/what/enddate	Attribute, Table 13
/dataset1/what/endtime	Attribute, Table 13
/dataset1/data1	Group
/dataset1/data1/data	Dataset
/dataset1/data1/data/CLASS	Attribute, Table 17
/dataset1/data1/data/IMAGE_VERSION	Attribute, Table 17
/dataset1/data1/what/quantity	Attribute, Table 16
/dataset1/data1/what/gain	Attribute, Table 13
/dataset1/data1/what/offset	Attribute, Table 13
/dataset1/data1/what/nodata	Attribute, Table 13
/dataset1/data1/what/undetected	Attribute, Table 13
/dataset1/data1/quality1	Group

*continued on next page*



*continued from previous page*

Attribute name	Type
/dataset1/data1/quality1/data	Dataset
/dataset1/data1/quality1/what	Group
/dataset1/data1/quality1/what/gain	Attribute, Table 13
/dataset1/data1/quality1/what/offset	Attribute, Table 13
<b>H5IM optional attributes</b>	
/dataset1/data1/data/PALETTE	Link to /dataset1/data1/palette
/dataset1/data1/data/IMAGE_SUBCLASS	Attribute
/dataset1/data1/palette	Dataset
/dataset1/data1/palette/CLASS	Attribute
/dataset1/data1/palette/PAL_VERSION	Attribute

### 7.3 Vertical profile

The following example shows how a vertical profile is represented.

Table 21: Vertical profile.

Attribute name	Type
/	Root Group
/Conventions	Attribute, Section 4.1
/what	Group
/what/object	Attribute, Table 2
/what/version	Attribute, Table 1
/what/date	Attribute, Table 1
/what/time	Attribute, Table 1
/what/source	Attribute, Table 3
/where	Group
/where/lon	Attribute, Table 7
/where/lat	Attribute, Table 7
/where/height	Attribute, Table 7
/where/levels	Attribute, Table 7
/where/interval	Attribute, Table 7
/where/minheight	Attribute, Table 7
/where/maxheight	Attribute, Table 7
/dataset1	Group
/dataset1/what	Group
/dataset1/what/product	Attribute, Table 14
/dataset1/what/prodname	Attribute, Table 13
/dataset1/what/startdate	Attribute, Table 13
/dataset1/what/starttime	Attribute, Table 13
/dataset1/what/enddate	Attribute, Table 13
/dataset1/what/endtime	Attribute, Table 13
/dataset1/data1	Group
/dataset1/data1/what	Group

*continued on next page*

*continued from previous page*

Attribute name	Type
/dataset1/data1/what/quantity	Attribute, Table 16
/dataset1/data1/what/gain	Attribute, Table 13
/dataset1/data1/what/offset	Attribute, Table 13
/dataset1/data1/what/nodata	Attribute, Table 13
/dataset1/data1/what/undetected	Attribute, Table 13
/dataset1/data1/data	Dataset
/dataset1/data2	Group
/dataset1/data2/what	Group
/dataset1/data2/what/quantity	Attribute, Table 16
/dataset1/data2/what/gain	Attribute, Table 13
/dataset1/data2/what/offset	Attribute, Table 13
/dataset1/data2/what/nodata	Attribute, Table 13
/dataset1/data2/what/undetected	Attribute, Table 13
/dataset1/data2/data	Dataset
/dataset1/data3	Group
/dataset1/data3/what	Group
/dataset1/data3/what/quantity	Attribute, Table 16
/dataset1/data3/what/gain	Attribute, Table 13
/dataset1/data3/what/offset	Attribute, Table 13
/dataset1/data3/what/nodata	Attribute, Table 13
/dataset1/data3/what/undetected	Attribute, Table 13
/dataset1/data3/data	Dataset

## 7.4 RHI

The following example shows how a polar RHI is represented.

Table 22: Range-height indicator.

Attribute name	Type
/	Root Group
/Conventions	Attribute, Section 4.1
/what	Group
/what/object	Attribute, Table 2
/what/version	Attribute, Table 1
/what/date	Attribute, Table 1
/what/time	Attribute, Table 1
/what/source	Attribute, Table 3
/where	Group
/where/lon	Attribute, Table 4
/where/lat	Attribute, Table 4
/where/height	Attribute, Table 4
/dataset1	Group
/dataset1/what	Group

*continued on next page*

*continued from previous page*

Attribute name	Type
/dataset1/what/product	Attribute, Table 14
/dataset1/what/prodname	Attribute, Table 13
/dataset1/what/prodpar	Attribute, Table 15
/dataset1/what/startdate	Attribute, Table 13
/dataset1/what/starttime	Attribute, Table 13
/dataset1/what/enddate	Attribute, Table 13
/dataset1/what/endtime	Attribute, Table 13
/dataset1/where	Group
/dataset1/where/az_angle	Attribute, Table 6
/dataset1/where/range	Attribute, Table 6
/dataset1/where/nbins	Attribute, Table 4
/dataset1/where/nrays	Attribute, Table 4
/dataset1/where/rstart	Attribute, Table 4
/dataset1/where/rscale	Attribute, Table 4
/dataset1/data1/what/quantity	Attribute, Table 16
/dataset1/data1/what/gain	Attribute, Table 13
/dataset1/data1/what/offset	Attribute, Table 13
/dataset1/data1/what/nodata	Attribute, Table 13
/dataset1/data1/what/undetected	Attribute, Table 13
/dataset1/data1	Group
/dataset1/data1/data	Dataset
/dataset1/data1/data/CLASS	Attribute, Table 17
/dataset1/data1/data/IMAGE_VERSION	Attribute, Table 17

## A Derivation of the radar calibration constant

It is very important for the radar constant to be defined properly. The following definition is used.

$$C = 10 \log_{10} \left( \frac{2.025 \cdot 2^{14} \cdot \ln(2) \cdot \lambda_{\text{cm}}^2}{\pi^5 \cdot 10^{-23} \cdot c \cdot Pt_{\text{kW}} \cdot \theta_{\text{deg}} \cdot \phi_{\text{deg}} \cdot \tau_{\mu\text{s}} \cdot |K|^2} \right) - 2G + 2L_r + L_{\text{Tx}} + L_{\text{Rx}} \quad (1)$$

where  $\lambda_{\text{cm}}^2$  is the wavelength in cm,

$c$  is the speed of light in vacuum in m/s ( $3.0 \times 10^8$ ),

$Pt_{\text{kW}}$  is the nominal transmitted power in kW,

$\theta_{\text{deg}}$  and  $\phi_{\text{deg}}$  are horizontal and vertical -3 dB beamwidths in degrees,

$\tau_{\mu\text{s}}$  is the pulse length in microseconds,

$|K|^2$  is the dielectric factor (0.93 for liquid water),

$G$  is the antenna gain in dB,

$L_r$  is the one-way radome loss in dB,

$L_{\text{Tx}}$  is the loss in the complete transmission chain, in dB, and

$L_{\text{Rx}}$  is the loss in the complete reception chain, in dB.

This definition of the radar constant is based on the following radar equation

$$dBZ = C + 20 \log_{10} r_{\text{km}} + 10 \log_{10} Pr_{\text{mW}} \quad (2)$$

where  $r_{\text{km}}$  is the distance from the radar in km, and

$Pr_{\text{mW}}$  is the received power in mW.