



Next-generation Wi-Fi

Wi-Fi 7 and beyond

Carlos Cordeiro

CTO, Wireless Communications

Intel Corporation

July 2020

Agenda

The background features a vibrant blue and purple gradient. It is decorated with various digital motifs: multiple Wi-Fi symbols of varying sizes and colors (white, yellow, and blue), dotted lines, small squares, and arrowheads pointing in different directions, creating a sense of connectivity and data flow.

Wi-Fi Generations

Wi-Fi Market and Growth

Major Trends Impacting Wireless Evolution

Fundamentals of Wi-Fi 7

Beyond Wi-Fi 7

Current Generations of Wi-Fi

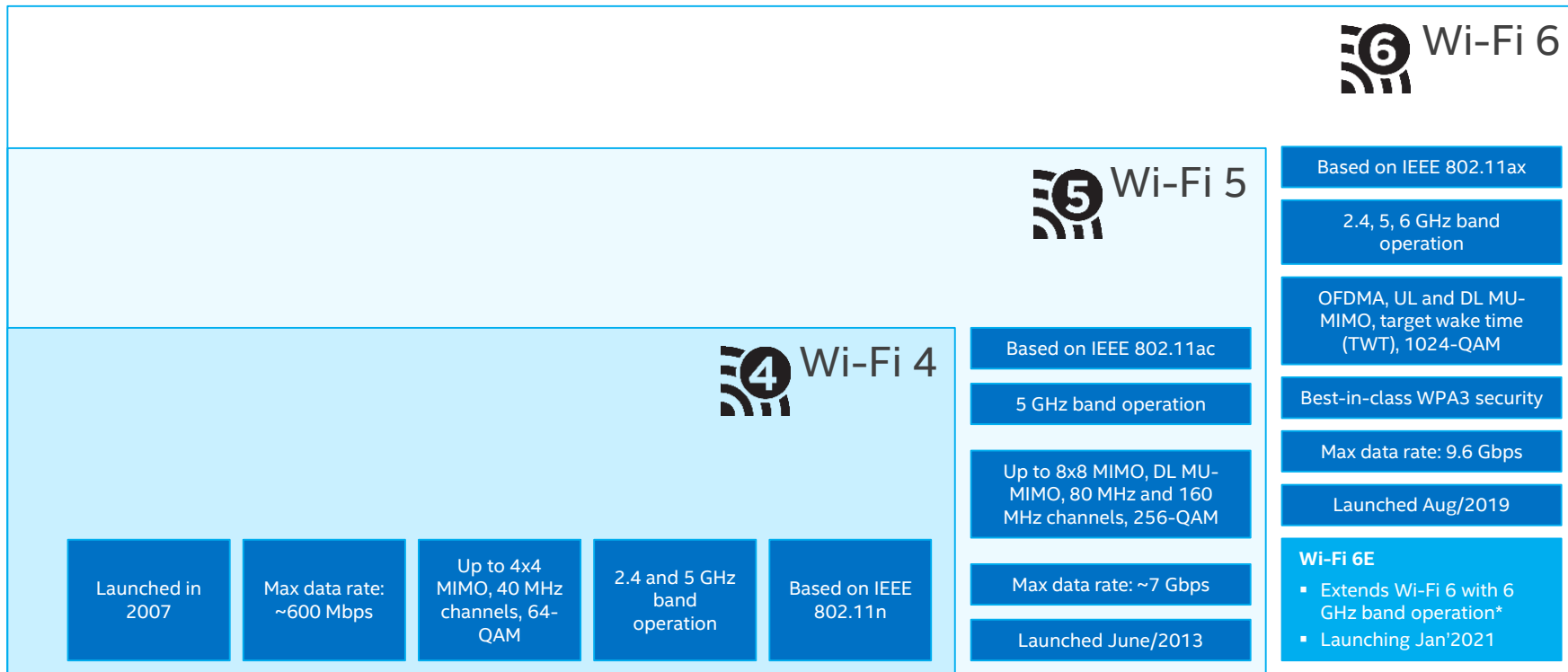

* 6 GHz operation subject to regulatory rules in each country.

Wi-Fi Market Economic Value

Wi-Fi economic value
~2 trillion in economic value in 2018

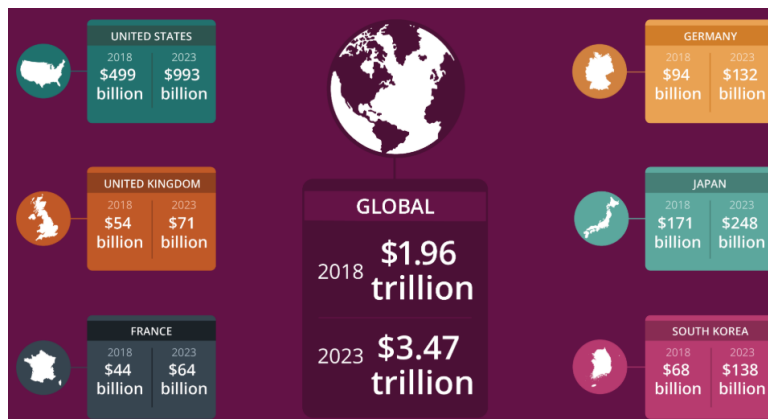

<https://www.wi-fi.org/value-of-wi-fi>

By 2022, ~60% of global mobile traffic will be offloaded to Wi-Fi and 51% of total IP traffic will be Wi-Fi*

* <https://www.networkworld.com/article/3341099/wi-fi-6-5g-play-big-in-ciscos-mobile-forecast.html>

New Experiences Demand Continuous Improvement

- New experiences (e.g., industrial IoT, 3D/XR content, real-time collab.) demand **more responsive connectivity**
- Compute shifting closer to the user, thereby **redefining end-to-end (E2E) network performance**
 - e.g., low, single-digit and sub-1ms latency become broadly available
- Low E2E latency across the network enables new services and experiences

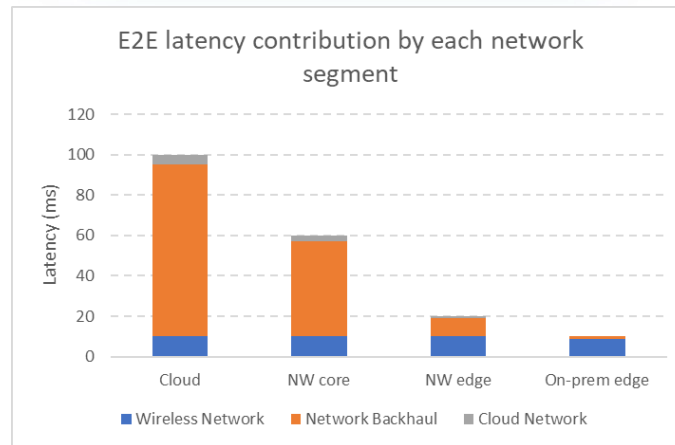
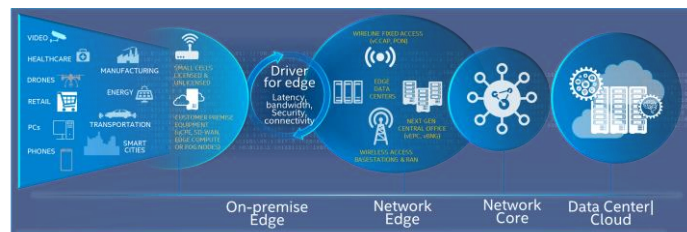

High performance wireless access essential to meet growing demand

Wi-Fi 6/6E: A Giant Leap Forward

4X GREATER SCALABILITY

OFDMA enables managed, reliable, efficient connectivity across more devices. This means plenty of headroom for future growth or fewer APs required to support existing devices.

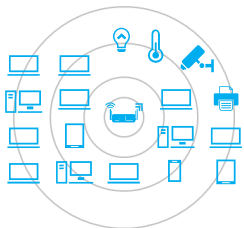

REDUCED INTERFERENCE

OBSS enhancements help routers and devices identify local traffic and tune out noise from other networks.

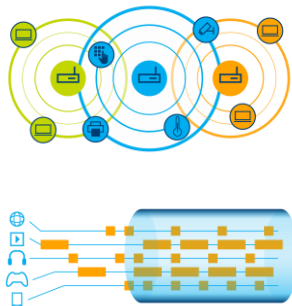

IMPROVED SECURITY

Wi-Fi 6 uses new WPA3 security features, enabling next-generation authentication and best-in-class encryption.



Improved Protection

3X FASTER PERFORMANCE

1024 QAM and support for optional 160 MHz channels enable clients and routers to deliver best-in-class Gigabit speeds for the office or home.

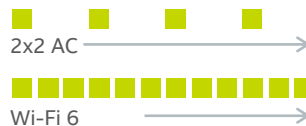

RESPONSIVE! ~75% LOWER LATENCY

Wi-Fi 6 helps slash lag times to give you the edge you need to win with OFDMA data management and OBSS interference avoidance features.



Increasingly stringent usage (e.g., industrial IoT, AR/VR, robotics, cloud gaming) requirements demand continued evolution

Up Next: Wi-Fi 7

Based on IEEE P802.11be

P802.11be project goals*

- Amendment to 802.11, building on 11ax
- Maximum throughput of at least 30 Gbps
- Frequency range: between 1 & 7.250 GHz
- Improvements to worst-case latency & jitter

Targeted usages

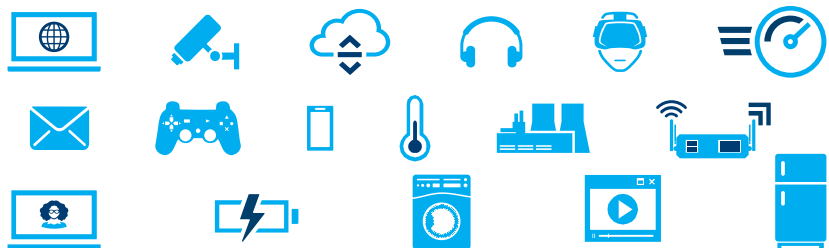

Target timeline

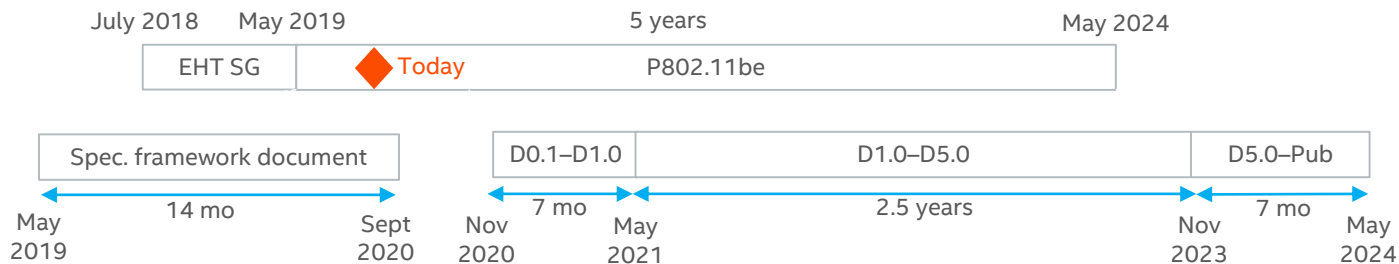

* http://www.ieee802.org/11/PARs/P802_11be_PAR_Detail.pdf

Key Wi-Fi 7 Features*



User Experience Data Rate



Spectrum Efficiency



Network Energy Efficiency



Connection Density

Key Enhancements

320 MHz channels

4096-QAM

16 spatial streams

Multi-link operation

Multi-AP operation

Deterministic low latency

Multi-RU (puncturing)



Peak Data Rate



Cost Effective



Area Capacity



Low Latency

* Accurate as of June/2020. Feature set and their specification are subject to change.

PHY Enhancements: Basics

Preamble and packet format

- Universal SIG (U-SIG) defined for forward compatibility (e.g., version, UL/DL, TXOP duration)
- EHT-SIG with common and user-specific parts

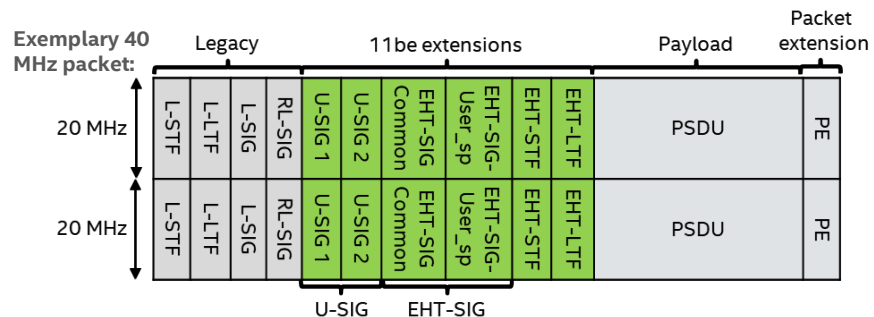

Channelization and 320 MHz channels

- Max single channel bandwidth increased from 160 MHz (Wi-Fi 6/6E) to 320 MHz
- Tone plan for 320 MHz use duplicated 160 MHz tone plan based on Wi-Fi 6

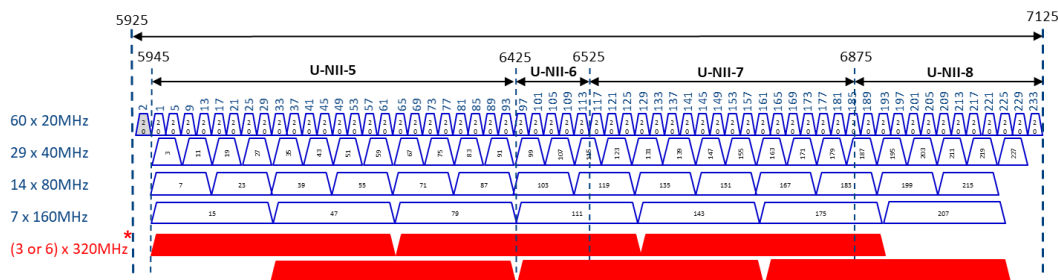

PHY Enhancements: Multi-RU (Puncturing)

- Multi-RU is created by puncturing the operating channel
 - Puncturing granularity = 20 MHz
- Main motivation is to avoid transmitting on frequencies that are locally unauthorized by regulation due to incumbent operation

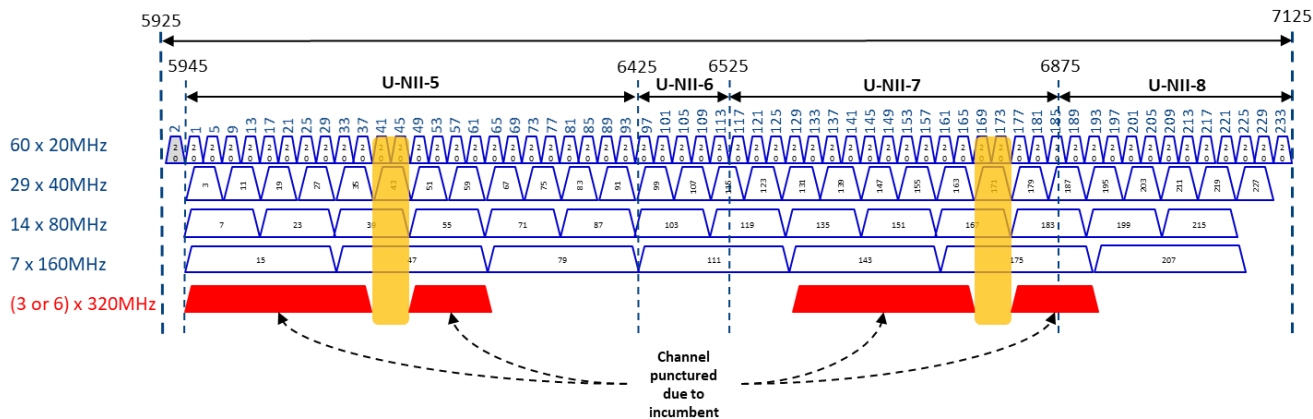

PHY Enhancements: Data Rate

Parameter	Wi-Fi 6	Wi-Fi 7
Max channel bandwidth	160 MHz	320 MHz (3 channels in 6 GHz)
Highest modulation order	1024-QAM	4096-QAM
Max number of spatial streams	8	16
Max data rate*	~9.6 Gbps	~46.1 Gbps

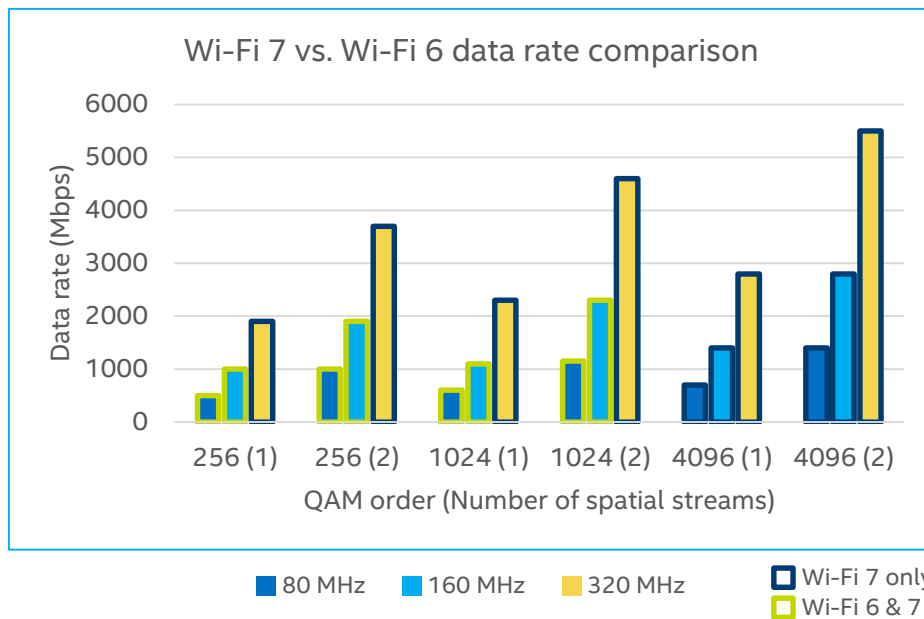

Max data rate increase of about 4.8x compared to Wi-Fi 6

* This reflects the maximum theoretical data rate. Practical data rates depend on many factors, including on the capabilities of an AP and its associated clients.

Multi-link Operation (MLO)

MLO enables link aggregation at the MAC layer

- A link is mapped to a channel and band

MLO brings benefits in multiple dimensions:

- Additive throughput for data flows split over links
 - For two links (e.g., 5 GHz and 6 GHz), max aggregate data rate could reach 7.2x compared to Wi-Fi 6
- Lower latency due to access to multiple links in parallel
- High reliability by packets duplication over multiple links
- Assign data flows to specific links based on app needs

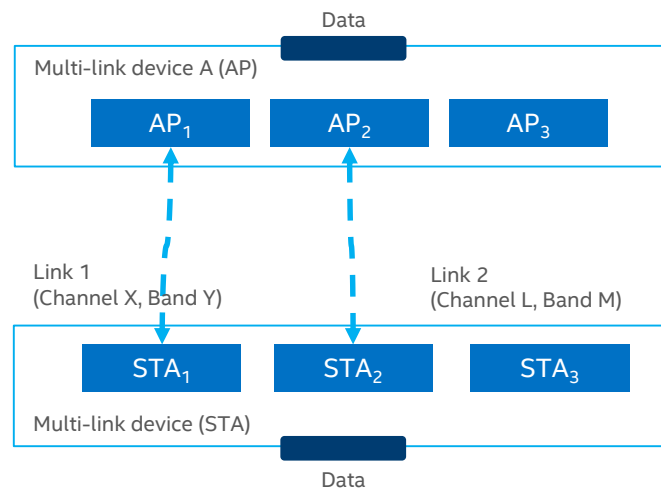

MLO provides higher throughput, lower latency and/or higher reliability, which are useful to a number of applications from VR/AR to industrial IoT

Multi-link Operation: Types of MLO

Different MLO implementation options are possible

MLO type	No. of full function 11be radios	Characteristics
Multi-link single radio (MLSR)	1	Able to RX and TX over one radio at a time
Enhanced MLSR (eMLSR)		Enhances MLSR with a reduced function radio to choose best link
Non-simultaneous TX and RX multi-link multi radio (Non-STR MLMR)	≥ 2	Able to simultaneously RX and TX over ≥ 2 radios, but only under certain constraints (e.g., freq. separation, aligned TX/RX)
STR MLMR		Able to simultaneously RX and TX over ≥ 2 radios

Complexity & performance

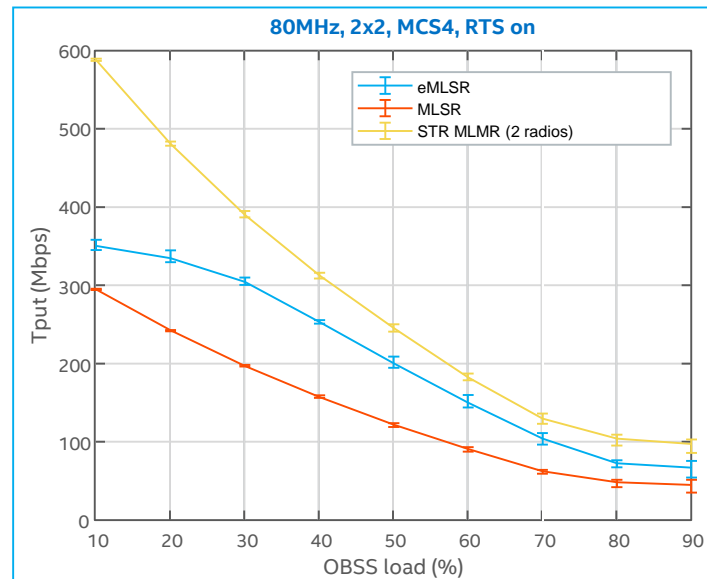

Multi-AP Features

Multi-AP refers to a collection of features that rely on direct AP coordination to achieve desired network performance goals

Different flavors of multi-AP solutions are being considered

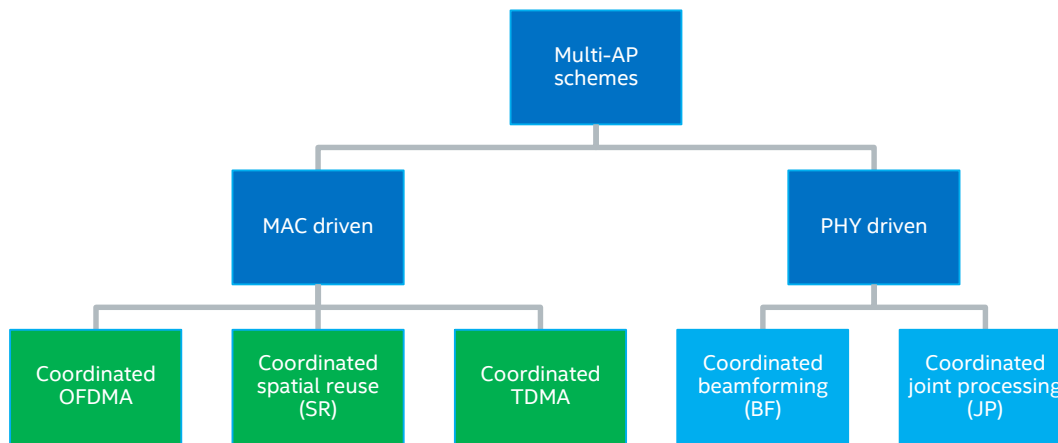
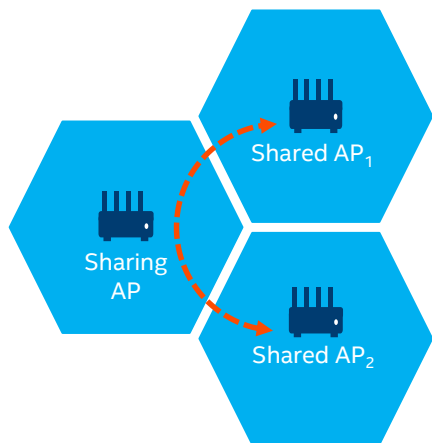

Multi-AP Features: MAC Driven

Coordinated OFDMA, Spatial Reuse (SR) & TDMA

A sharing AP triggers shared AP(s) so that shared AP(s) can perform one of:

Coordinated OFDMA

AP(s) transmit simultaneously to their associated STAs on different OFDMA resource units

Example

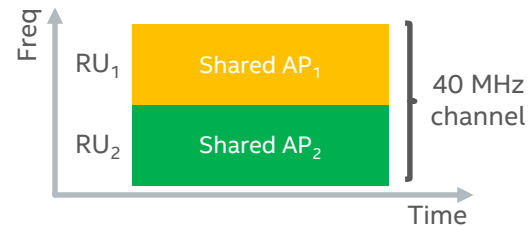

Coordinated SR

AP(s) transmit simultaneously to their associated STAs on the same resource units

Example

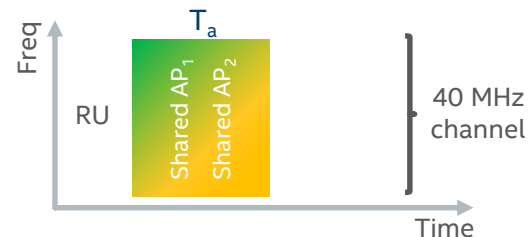

Coordinated TDMA

AP(s) take turn in transmitting to their associated STAs on the same resource units

Example

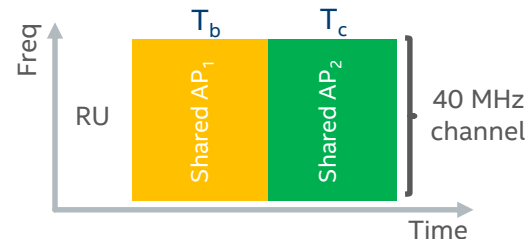

Multi-AP Features: PHY Driven

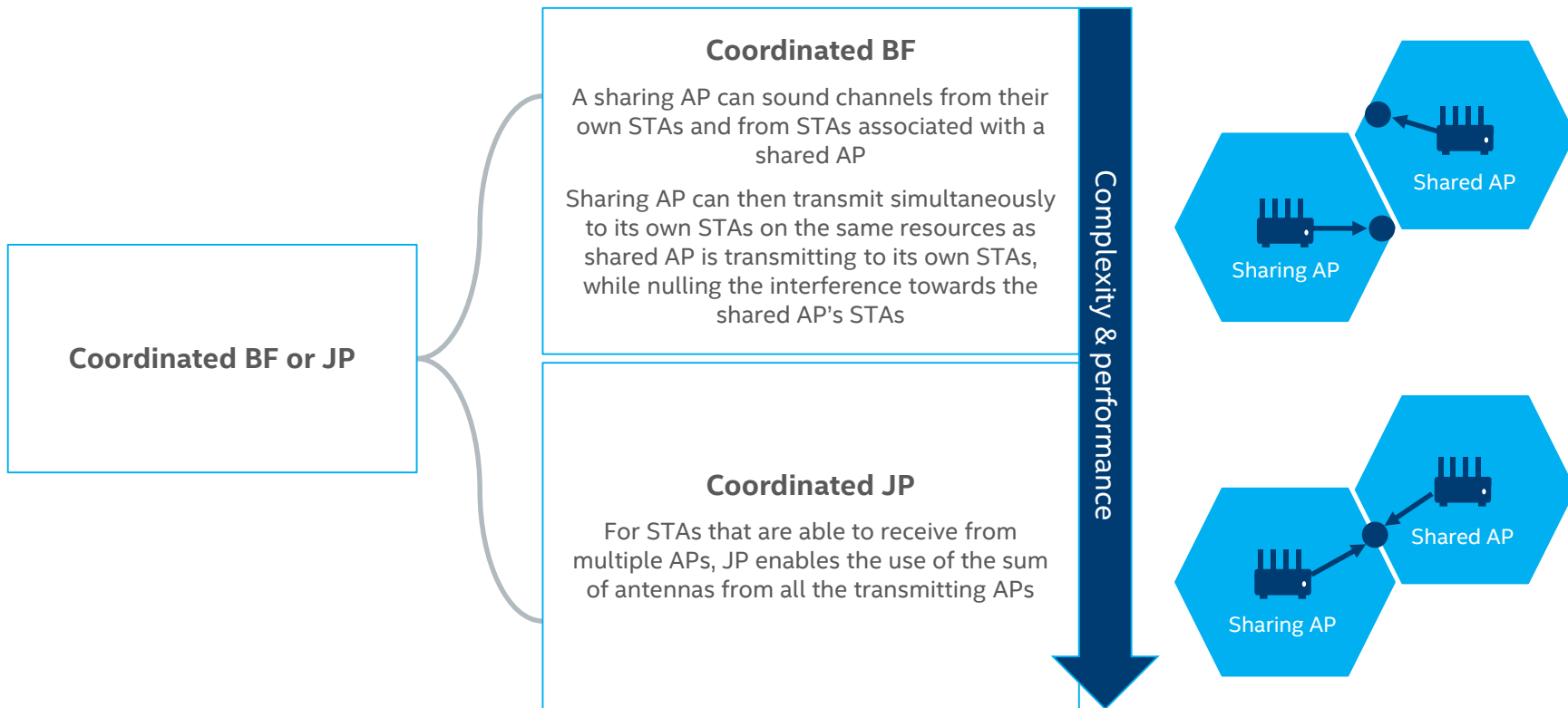

Deterministic Low Latency Enhancements

- **Wi-Fi 6 can achieve single-digit millisecond** latency, but the worst-case latency can be high in congested environments
- With the introduction of features like multi-link operation, multi-AP and 320 MHz channels in Wi-Fi 7, latency will be reduced even further
- However, to provide deterministic low latency required by some usages (e.g., industrial IoT, AR/VR), new schemes need to be defined

Potential Wi-Fi 7 features for deterministic low latency

- Define QoS provisioning model with dedicated, deterministic, low-latency (LL) and reliable access category
- Scheduled channel access with 802.1 TSN functionality
- Packet preemption for predictable channel access
- Limit TXOP duration across networks

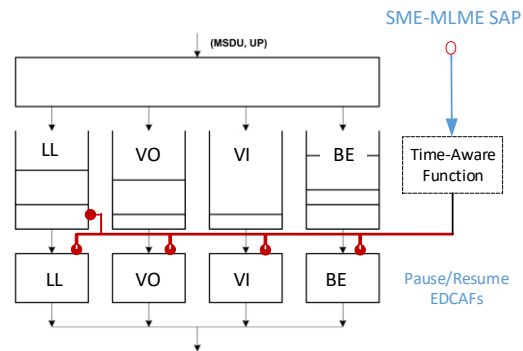

OpenRoaming: Anywhere & Any Network Connected Wi-Fi Clients

Problem Statement

Wi-Fi hotspots can be found virtually everywhere, but clients connecting to these hotspots are either disallowed (e.g., lack of credentials) or cumbersome (e.g., captive portal)

Solution

OpenRoaming (OR) is an industry initiative that aims at connecting clients to Wi-Fi networks as seamless and pervasive as in cellular

- Based on Passpoint technology
- Scalable, many-to-many business relationships

OpenRoaming Players

Ecosystem Brokers

- Infra vendors
- Cert. authorities



Identity Providers

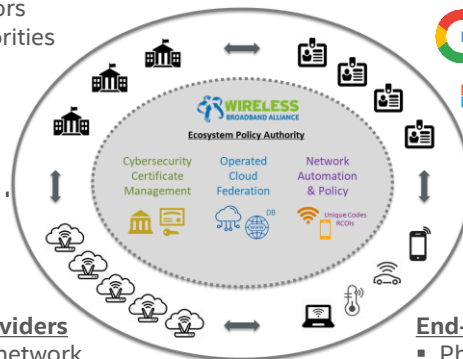

Network Providers

- Any Wi-Fi network
- Monetization: soft portal, business deal with ID provider, etc.



End-Users/Devices

- Phones, PCs, IoT, etc.
- Broad OS support



OpenRoaming enables seamless connectivity of Wi-Fi clients across networks

Wi-Fi Sensing

Wi-Fi sensing exploits channel changes measured by amplitude and phase

- Channel varies as changes in the environment alter the paths
- ML/signal processing can infer the cause (e.g., human presence, activity)
- Single device or multi-device sensing possible

IEEE 802.11 established a study group on Wi-Fi sensing (likely to become 802.11bf)

- Applies to 2.4/5/6/60 GHz

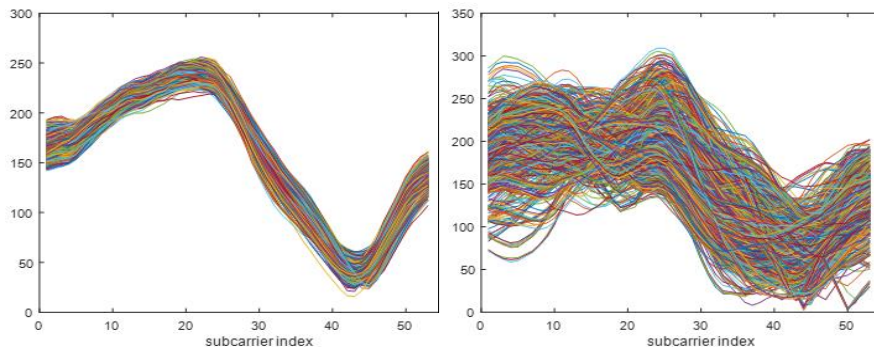
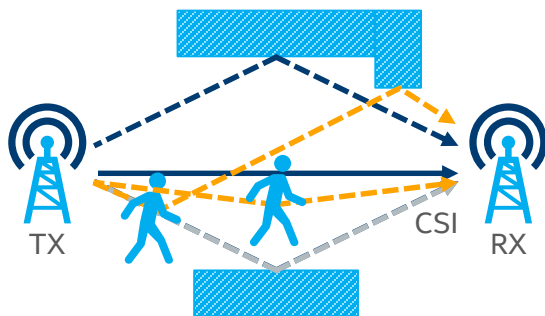

Amplitude, static environment (no motion)

Amplitude, dynamic environment (motion)

Applications of Wi-Fi Sensing

Enterprise



Security, environment control



Wake on approach, walk away lock



Conference room occupancy

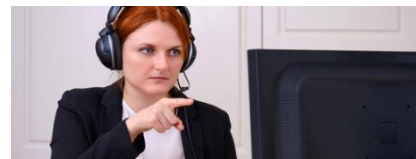

Gesture control

Residential



Security, environment control



Elderly monitoring



Baby monitoring



Gesture control

Retail and Hospitality



Environment control, Smart housekeeping



Signage efficiency



Gesture control

Capabilities

Motion detection

Proximity detection

People counting

Human activity recognition

Vital signs detection

Wi-Fi Continues to Transform the Landscape



New Wi-Fi 7 innovations

320 MHz channels, multi-link operation, 4K-QAM, multi-AP, deterministic low latency

Wi-Fi 7 will build on Wi-Fi 6/6E

- **Need to open the entire 1200 MHz of the 6 GHz band for unlicensed use**
- Optimal use of the 6 GHz band, even lower latency, even higher throughput, even higher reliability, even more secure

Wi-Fi will become even better

- Video streaming, video/voice conferencing, wireless gaming, real-time collaboration, cloud/edge compute, industrial IoT, immersive AR/VR, interactive telemedicine, etc.
- OpenRoaming and Wi-Fi sensing

The future is bright for Wi-Fi!

Notices & Disclaimers

Intel technologies may require enabled hardware, software or service activation.

No product or component can be absolutely secure.

Results have been estimated or simulated.

No license (express or implied, by estoppel or otherwise) to any intellectual property rights is granted by this document.

Intel, the Intel logo, and other Intel marks are trademarks of Intel Corporation or its subsidiaries.

Other names and brands may be claimed as the property of others.

Copyright © Intel Corporation.

