

Unesco technical papers  
in marine science 60

## Reference materials for oceanic carbon dioxide measurements

Report of the sub-panel on standards  
for CO<sub>2</sub> measurements of the  
Joint Panel on Oceanographic Tables  
and Standards

sponsored by  
SCOR, UNESCO, ICES, IAPSO

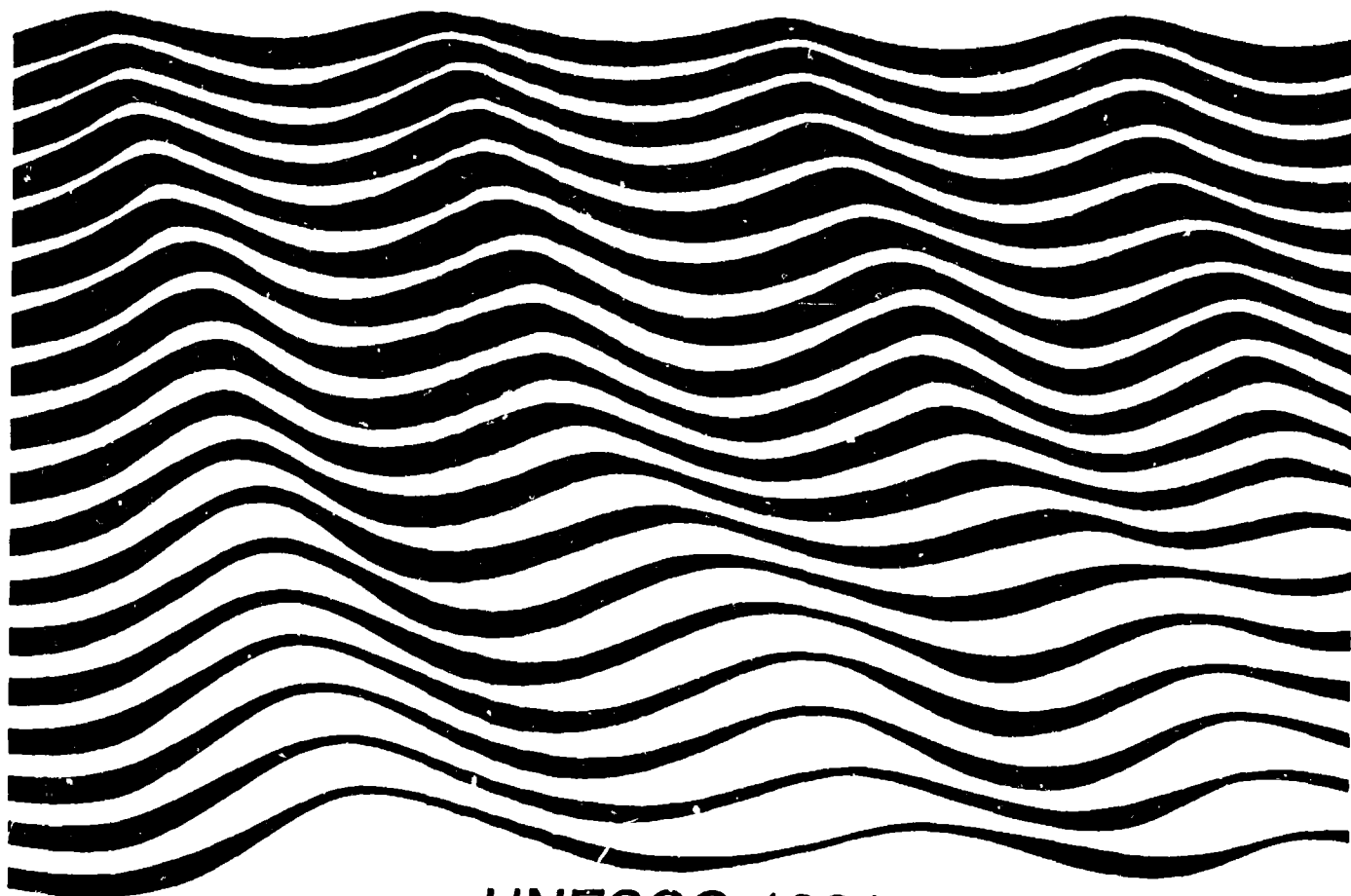

UNESCO 1991

## UNESCO TECHNICAL PAPERS IN MARINE SCIENCE

Issues 1-30, 32, 37 and 50 are out of stock. For availability in microfiche form please write to the Unesco Press, Sales Division (UPP/V), 7 Place de Fontenoy, 75700 Paris, France.  
Out of stock titles are listed on the back cover.

| No   | Year | SCOR<br>WG | No  | Year | SCOR<br>WG |
|--|------|------------|---|------|------------|
| 31 Coastal lagoon survey (1976-1978)   | 1980 | —          | 46 Opportunities and problems in satellite measurements of the sea<br>Report of SCOR Working Group 70<br>Available in Ar., Ch., F., R., and S   | 1986 | WG 70      |
| 33 Coastal lagoon research, present and future. Proceedings of a seminar, Duke University, August 1978 (Unesco, IABO).   | 1981 | —          | 47 Research on coastal marine systems. Report of the third meeting of the UNESCO/SCOR/IABO consultative panel on coastal systems, October 1984  | 1986 | —          |
| 34 The carbon budget of the oceans. Report of a meeting, Paris, 12-13 November 1979  | 1980 | WG 62      | 48 Coastal off-shore ecosystems relationships. Final Report of SCOR/IABO/UNESCO Working Group 65<br>Texel, Netherlands, September 1983  | 1986 | WG 65      |
| 35 Determination of chlorophyll in seawater. Report of intercalibration tests sponsored by SCOR and carried out by C.J. Lorenzen and S.W. Jeffrey, CSIRO Cronulla, N.S.W., Australia, September-October 1978   | 1980 | —          | 49 Pelagic biogeography<br>Proceedings of an international conference<br>The Netherlands 29 May-5 June 1985   | 1986 | —          |
| 36 The practical salinity scale 1978 and the international equation of state of seawater 1980<br>Tenth report of the Joint Panel on Oceanographic Tables and Standards, (JPOSTS), Sidney, B.C., Canada, 1-5 September 1980<br>Sponsored by Unesco, ICES, SCOR, IAPSO<br>Available in Ar., Ch., F., R., S   | 1981 | WG 10      | 51 Thermodynamics of the carbon dioxide system in seawater. Report by the carbon dioxide subpanel of the joint panel on oceanographic tables and standards  | 1987 | —          |
| <i>(Примечание: Этот доклад (текст идентичен) был первоначально дан только на английском языке под заголовком Tenth report of the Joint Panel on Oceanographic Tables and Standards (Десятый доклад Объединенной группы по океанографическим таблицам и стандартам)). Имеется на арабском, испанском, китайском, русском и французском языках.</i> |      |            | 52 Research on coastal marine systems. Review and Recommendations for UNESCO Programme 1987-1989<br>Report of the fourth meeting of the UNESCO/SCOR/IABO consultative panel on coastal systems, Dakar, 15-17 December 1986  | 1987 | —          |
| 38 Background papers and supporting data on the International Equation of State of Seawater 1980.  | 1981 | WG 10      | 53 Code of practice for scientific diving. Principles for the safe practice of scientific diving in different environments. Compiled and edited by the Scientific Committee of the Confédération mondiale des activités subaquatiques (CMSA)                        | 1988 | —          |
| 39 International Oceanographic Tables, Vol. 3  | 1981 | WG 10      | 54 The acquisition, calibration and analysis of CTD data<br>A report of SCOR Working Group 51   | 1988 | WG 51      |
| 40 International Oceanographic Tables, Vol. 4.   | 1982 | WG 10      | 55 River inputs to ocean systems:<br>Status and recommendations for research<br>Final Report of SCOR Working Group 46   | 1988 | WG 46      |
| 41 Ocean-Atmosphere Materials exchange (OAMEX)<br>Report of SCOR Working Group 44,<br>Unesco, Paris, 14-16 November 1979   | 1982 | WG 44      | 56 The ocean as a source and sink for atmospheric trace constituents<br>Final Report of SCOR Working Group 72   | 1989 | WG 72      |
| 42 Carbon dioxide sub-group of the joint panel on oceanographic tables and standards. Report of a meeting Miami, Florida, 21-23 September 1981 sponsored by Unesco, ICES, SCOR, IAPSO  | 1983 | —          | 57 Coastal marine systems: Review and research recommendations, 1988-1990 UNESCO/SCOR/IABO consultative panel on coastal systems<br>15-20 December 1988<br>São Luis, Maranhao, Brazil   | 1989 | —          |
| 43 International Symposium on Coastal Lagoons<br>Bordeaux, France, 8-14 September 1981<br>Available in F. and S  | 1982 | —          | 58 Directory of source materials for the history of oceanography  | 1990 | —          |
| 44 Algorithms for computation of fundamental properties of seawater. Endorsed by Unesco SCOR/ICES/IAPSO Joint Panel on Oceanographic Tables and Standards and SCOR Working Group 51.   | 1983 | —          | 59 Intercomparison of total alkalinity and total inorganic carbon determinations in seawater. Recommended by ICES Marine Chemistry Working Group and SCOR Working Group 75 and endorsed by SCOR/UNESCO/ICES/IAPSO Joint Panel on Oceanographic Tables and Standards | 1991 | —          |
| 45 The International System of Units (SI) in Oceanography. Report of IAPSO Working Group on Symbols, Units and Nomenclature in Physical Oceanography. (SUN)  | 1985 | —          |   |      |            |

# Reference materials for oceanic carbon dioxide measurements

Report of the sub-panel on standards  
for CO<sub>2</sub> measurements of the  
Joint Panel on Oceanographic Tables  
and Standards

sponsored by  
SCOR, UNESCO, ICES, IAPSO

ISSN 0503-4299

Published in 1991  
by the United Nations Educational,  
Scientific and Cultural Organization  
7,place de Fontenoy, 75700 Paris  
Printed in UNESCO's workshops.

© UNESCO 1991  
*Printed in France*

Reproduction authorized, providing that appropriate  
mention is made of *UNESCO Technical Papers in Marine  
Science* and voucher copies are sent to  
the Division of Marine Sciences.

## PREFACE

This series, the *Unesco Technical Papers in Marine Science*, is produced by the Unesco Division of Marine Sciences as a means of informing the scientific community of recent advances in oceanographic research and on recommended research programmes and methods.

The texts in this series are prepared in co-operation with non-governmental scientific organizations. Many of the texts result from research activities of the Scientific Committee on Oceanic Research (SCOR) and are submitted to Unesco for printing following final approval by SCOR of the relevant working group report.

The distribution of *Unesco Technical Papers in Marine Science* is restricted to libraries of oceanographic institutions and governmental authorities, and documentation centres. Individual requests from specialists will, however, be examined by the Division and dealt with on a selective basis. Requests for individual titles or additions to the mailing list should be addressed to:

Marine Information Centre  
Division of Marine Sciences  
Unesco  
Place de Fontenoy  
75700 Paris,  
France.

---

The designations employed and the presentation of the material in this document do not imply the expression of any opinion whatsoever on the part of the Unesco Secretariat concerning the legal status of any country, territory, city or area or of its authorities, or concerning the delimitation of its frontiers or boundaries. The ideas and opinions expressed are those of the authors and do not necessarily represent the views of Unesco.

## ABSTRACT

This report contains the results of the deliberations of the JPOTS sub-panel on standards for CO<sub>2</sub> measurements at their three meetings (Vancouver, 1987; Acapulco, 1988; La Jolla, 1990). It emphasizes the need for reference materials for the quality control of oceanic carbon dioxide measurements, and details those factors that must be considered in the preparation and certification of such reference materials. The report goes on to describe the progress that has been achieved towards producing such materials, and recommends the further steps that need to be undertaken to implement an adequate quality control plan for CO<sub>2</sub> measurements made as part of international programs such as the Joint Global Ocean Flux Study (JGOFS).

## RESUME

Le présent rapport contient les conclusions auxquelles le sous-groupe du JPOTS sur les normes applicables à la mesure du CO<sup>2</sup> est parvenu au terme des trois réunions qu'il a tenues à Vancouver (1987), Acapulco (1988) et La Jolla (1990). La nécessité de disposer de matériels de référence pour le contrôle de la qualité des mesures de gaz carbonique dans l'océan est mise en évidence et les facteurs qui doivent être pris en considération lors de l'élaboration et de l'homologation de ces matériels sont exposés en détail. Viennent ensuite une description des progrès réalisés dans la production de ces matériels ainsi que des recommandations sur les dispositions supplémentaires à prendre pour mettre en oeuvre un plan adéquat de contrôle de la qualité des mesures de CO<sup>2</sup> effectuées dans le cadre de programmes internationaux tels que l'Etude conjointe sur les flux océaniques mondiaux (JGOFS).

## RESUMEN

En el presente informe se exponen los resultados de las deliberaciones de las tres reuniones del Subgrupo del JPOTS sobre normas de medición del dióxido de carbono (Vancouver, 1987; Acapulco, 1988; La Jolla, 1990). Se destaca la necesidad de disponer de materiales de referencia para el control de calidad de las mediciones de dióxido de carbono en el océano y se detallan los factores que es preciso tener en cuenta al preparar y certificar dichos materiales. Se describen, además, los adelantos que se han hecho en la preparación de éstos y se recomiendan las medidas complementarias que deben adoptarse para aplicar un plan adecuado de control de calidad a las mediciones de dióxido de carbono que forman parte de programas internacionales, entre los que cabe citar el Estudio Mundial Conjunto de los Flujos Oceánicos (JGOFS).

## РЕЗЮМЕ

В настоящем докладе приводятся результаты прений подгруппы ОГОТС по стандартам для замеров содержания двуокиси углерода в ходе трех совещаний (Ванкувер, 1987 г.; Акапулько, 1988 г.; Ла Джолла, 1990 г.). В нем подчеркивается необходимость предоставления справочных материалов для контроля качества замеров содержания двуокиси углерода в океане и подробно излагаются факторы, которые необходимо учитывать при подготовке и сертификации таких справочных материалов. Далее в докладе дается характеристика достигнутых результатов в области подготовки таких материалов и приводятся рекомендации относительно дальнейших мер, которые необходимо принять для выполнения надлежащего плана контроля качества за замером содержания двуокиси углерода, осуществляемого в качестве международных программ, таких, как Совместное изучение потоков мирового океана (СИПМО).

## ملخص

يتضمن هذا التقرير نتائج مداوات لجنة الخبراء الفرعية التابعة للجنة المشتركة الخاصة بالجدول والمعايير الاقياونوغرافية (جبوتس) بشأن معايير عمليات قياس ثاني أكسيد الكربون أثناء اجتماعاتها الثلاثة (فانكوفر، ١٩٨٧، أكابولكو، ١٩٨٨، لاجولا، ١٩٩٠). وهو يؤكد على الحاجة الى توافر مواد مرجعية من أجل مراقبة نوعية عمليات قياس ثاني أكسيد الكربون في المحيطات، وبيين بالتفصيل العوامل التي ينبغي أن تؤخذ بعين الاعتبار لدى اعداد هذه المواد المرجعية واعتمادها. ويعرض التقرير التقدم الذي أحرز في سبيل انتاج هذه المواد، ويوصي بالتدابير التي ينبغي اتخاذها لتنفيذ خطة ملائمة لمراقبة نوعية عمليات قياس ثاني أكسيد الكربون بوصفها جزءا من البرامج الدولية مثل الدراسة العالمية المشتركة لجريان المحيطات (جونس).

## 摘 要

本报告包括海洋学表格与标准联合工作组(JPOTS) 下属有关二氧化碳测量标准的分工作组三次会议(温哥华1987年; 阿卡普尔科, 1988年; 拉霍亚, 1990年) 审议的结果。它强调指出控制海洋二氧化碳测量的质量需要有参考资料, 并详细介绍了编写和批准这种参考资料必须考虑的各种因素。该报告还进一步讲述了生产这种资料方面已经取得的进展, 并就实施作为全球海洋通量研究(JGOFs) 这类国际计划组成部分而制定的充分控制二氧化碳测量质量计划需要进一步采取的步骤提出了建议。

## TABLE OF CONTENTS

|   |    |
|---|----|
| Terms of reference .....  | ii |
| Membership of the sub-panel.....  | ii |
| Meeting dates.....  | ii |
| Introduction .....  | 1  |
| Results of an intercomparison study .....   | 2  |
| The role of reference materials .....   | 4  |
| The chemistry of CO <sub>2</sub> in the oceans.....   | 5  |
| Thermodynamic equations .....   | 5  |
| The analytical parameters of the CO <sub>2</sub> system in sea water.....                   | 7  |
| Analytical methods in current use.....  | 7  |
| Total alkalinity, A <sub>T</sub> .....  | 7  |
| Total dissolved inorganic carbon, C <sub>T</sub> .....                                      | 8  |
| The fugacity of CO <sub>2</sub> gas in equilibrium with sea water, f(CO <sub>2</sub> )..... | 9  |
| The hydrogen ion concentration of sea water, pH.....  | 10 |
| Preparation and certification of reference materials .....                                  | 11 |
| Certification of reference materials for the various parameters.....                        | 12 |
| Total alkalinity, A <sub>T</sub> .....  | 12 |
| Total dissolved inorganic carbon, C <sub>T</sub> .....                                      | 13 |
| The fugacity of CO <sub>2</sub> gas in equilibrium with sea water, f(CO <sub>2</sub> )..... | 13 |
| “Total” hydrogen ion concentration, pH.....   | 14 |
| Internal consistency of the chemical model for the CO <sub>2</sub> system .....             | 14 |
| C <sub>T</sub> from titration and from extraction.....                                      | 15 |
| Internal consistency of a potentiometric titration .....                                    | 15 |
| Equilibrium constants .....   | 15 |
| Overdetermined systems .....  | 17 |
| Analytical quality control.....   | 18 |
| Standard operating procedures and the use of reference materials .....                      | 18 |
| Demonstration of statistical control.....   | 18 |
| Further intercalibration exercises .....  | 19 |
| Progress to date .....  | 22 |
| Recommendations of the sub-panel.....   | 23 |
| Bibliography.....   | 25 |
| Annexe I  |    |
| Intercomparison of CO <sub>2</sub> measurements.....  | 30 |
| Annexe II   |    |
| Work in progress at the Scripps Institution of Oceanography, U. S. A. .                     | 34 |
| Annexe III  |    |
| Work in progress at the Institute for Ocean Sciences, Canada.....                           | 39 |



## TERMS OF REFERENCE†

- Co-ordination and assessment of work done towards preparing CO<sub>2</sub> standards for oceanic measurements.
- Development of recommendations for the production and use of such standards.

## MEMBERSHIP OF THE SUB-PANEL

- Dr. F. Culkin (IAPSO),  
Institute of Oceanographic Sciences, Deacon Laboratory, Brook Road,  
Wormley, Godalming, Surrey GU8 5UB, U.K.
- Dr. A. G. Dickson (SCOR), *Chairman*,  
Marine Physical Laboratory, Scripps Institution of Oceanography, La Jolla,  
CA 92093-0902, U.S.A.
- Dr. F. J. Millero (Unesco)  
Rosenstiel School of Marine and Atmospheric Science, 4600 Rickenbacker  
Causeway, Miami, FL 33149-1098, U.S.A.
- Dr. A. Poisson (ICES)  
Laboratoire de Physique et Chimie Marines, Université Pierre et Marie  
Curie, 75252 Paris Cedex 05, France.
- Dr. C. S. Wong (SCOR)  
Institute of Ocean Sciences, 9860 West Saanich Rd., P. O. Box 6000, Sidney,  
B.C. V8L 4B2, Canada.

## MEETING DATES

- Vancouver, British Columbia, Canada — August 13–15, 1987.  
In attendance: A. G. Dickson, A. Poisson, C. S. Wong, F. J. Millero, S. Morcos  
(Unesco), C.-T. A. Chen (Taiwan).
- Acapulco, Mexico — August 29–31, 1988.  
In attendance: A. G. Dickson, F. Culkin, A. Poisson, C. S. Wong,  
F. J. Millero, S. Morcos (Unesco), C.-T. A. Chen (Taiwan).
- La Jolla, California, U.S.A. — December 19–21, 1990.  
In attendance: A. G. Dickson, F. Culkin, A. Poisson, C. S. Wong,  
F. J. Millero, S. Morcos (Unesco).

---

† The establishment of this sub-panel was reported at the eighteenth general meeting of SCOR, held in Hobart, Australia, November 26–28, 1986.

## INTRODUCTION

A major goal of oceanography over the next ten years will be the co-ordinated study of oceanic processes on a global scale. The impetus comes from a desire to understand the factors which control climate and, conversely, how changes in climate affect biogeochemical systems. In particular, a clear grasp of the circulation of the oceans, the associated physical processes, and their biological, geological and chemical consequences, will be needed. Diurnal, seasonal, and interannual variations in the carbon cycle of the oceans, especially in near-surface water, are of central concern to the understanding of such biogeochemical cycles; nevertheless, our present knowledge is mainly inferred rather than based on direct measurements.

One aspect of the carbon cycle believed to have the potential to influence climate is the rising concentration of atmospheric carbon dioxide brought about by fossil fuel combustion. Although it is currently thought that about 40% of the CO<sub>2</sub> produced annually by combustion is being taken up by the oceans, there is very little direct evidence of this. Atmospheric CO<sub>2</sub> data further suggest that the carbon cycle in the upper ocean responds to climatic factors related to El Niño / Southern Oscillation events, but again there is little confirmation from oceanic measurements. We need observations which document changes in the fugacity of CO<sub>2</sub> in equilibrium with surface waters,  $f(\text{CO}_2)$ ,<sup>†</sup> in the total dissolved inorganic carbon,  $C_T$ , and in the total alkalinity,  $A_T$ , of the oceans, so as to discern the forces modulating the atmospheric CO<sub>2</sub> rise.

The need for extensive, reliable, oceanic carbon data has been recognized in the long-range plan of the Division of Ocean Sciences of the U. S. National Science Foundation (N.S.F., 1987) as a component of the Global Ocean Flux Study, and carbon dioxide data have been identified as core measurements for JGOFS\* (SCOR, 1988). These plans call for large-scale surveys and selective long-term time-series measurements of  $C_T$ ,  $A_T$ , and  $f(\text{CO}_2)$ . A variety of researchers from different countries will be involved in such observations, using various ships as research platforms. The planned measurements will take several years to complete, and we anticipate that some time-series will continue indefinitely so as to document longer period changes in the earth's

---

<sup>†</sup> In this document we refer to the *fugacity* of CO<sub>2</sub> in solubility equilibrium with the water sample (*i.e.* taking account of the non-ideal nature of the gas phase), rather than to the less rigorous  $P(\text{CO}_2)$ , the partial pressure of CO<sub>2</sub> in solubility equilibrium with a water sample.

\* The Joint Global Ocean Flux Study.

biogeochemical cycles. It is essential that care is taken to ensure that data collected at different times and by different investigators are comparable and correct.

Until recently, total dissolved inorganic carbon and total alkalinity have been difficult to measure precisely. There has consequently been little incentive to include these quantities in the suite of chemical parameters routinely measured in oceanic surveys. Thus, in spite of the central importance of the carbon dioxide system to the oceans, good observational carbon data are still very sparse. In the past few years several laboratories have claimed significant improvements in the general reliability of measurements of dissolved inorganic carbon and total alkalinity. The relevant signals of the oceanic carbon cycle can now be clearly documented, provided that reliable chemical standards are employed to calibrate these new methods and appropriate quality control measures taken. A key to achieving this lies in adherence to a carefully thought out quality assurance plan. This plan, together with the distribution and use of *certified reference materials*, should make possible long term quality control of the various oceanic measurements of  $C_T$ ,  $A_T$ ,  $f(\text{CO}_2)$ , and pH.

## RESULTS OF AN INTERCOMPARISON STUDY

An international intercomparison exercise was recently organized by Dr. Poisson and Dr. Culkin to examine the quality of the data obtained by different laboratories involved in  $\text{CO}_2$  programs. This exercise was suggested by SCOR† Working Group 75 (Methodology for oceanic  $\text{CO}_2$  measurements) and endorsed by this sub-panel. Preliminary results from this exercise were discussed briefly at our meeting in Acapulco, and a full report is now available (Unesco, 1990): the essential findings are reiterated here — for additional detail see Annexe I, a reprint of Poisson *et al.*, 1990. Four batches of sea water of salinity 8, 30, 35, and 38 were prepared and distributed by the IAPSO\* Standard Sea Water Service to twelve laboratories in nine countries who participated fully in the exercise. These samples were poisoned with mercuric chloride and bottled in Pyrex bottles (1000 cm<sup>3</sup>). The results obtained by the various participating laboratories for samples with a salinity of about 35 are shown in figures 1 and 2. It is apparent that there are significant problems in obtaining accurate results for these measurements. The precision of the individual laboratories is reasonable, although not always of the highest level; however, the agreement between laboratories is far worse, up to ten times the analytical precision.

These results demonstrate the well known, though rarely acknowledged, observation that individual laboratories can achieve a high degree of precision whilst disagreeing substantially from each other. One factor which is certain to have contributed to this effect, is that each laboratory used its own choice of analytical methods, whose details are usually unpublished, rather than every laboratory following a specified method according to a documented standard

---

† Scientific Committee on Oceanic Research

\* International Association for the Physical Sciences of the Ocean

operating procedure. This exercise further emphasizes the need for a carefully thought out quality assurance plan to provide a verification and evaluation of the precision and accuracy of oceanic carbon dioxide measurements. Without such a plan, it will not be possible to achieve a coherent international oceanic carbon dioxide program.

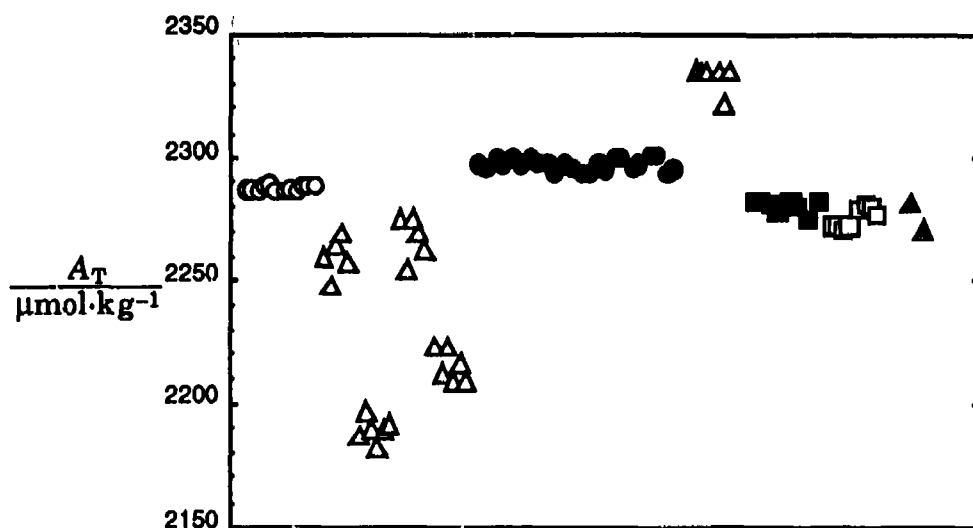

Figure 1. Total alkalinity results from a 1988 intercomparison exercise. Each point denotes a single measurement; the different symbols indicate measurements made in different laboratories.

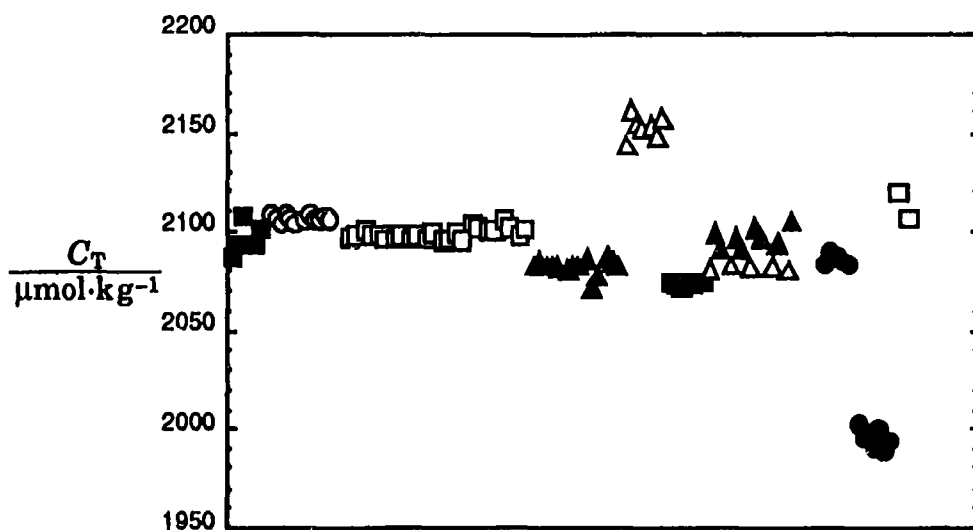

Figure 2. Dissolved inorganic carbon results from a 1988 intercomparison exercise. Each point denotes a single measurement; the different symbols indicate measurements made in different laboratories.

## THE ROLE OF REFERENCE MATERIALS

One aspect of a successful quality control scheme is the regular use of *reference materials* (see table 1). Reference materials are stable substances for which one or more properties are established sufficiently well to calibrate a chemical analyzer, or to validate a measurement process (Taylor, 1987). Ideally such materials are based on a matrix similar to that of the samples of interest, in this case sea water. The most useful reference materials would be those for which one or more properties have been *certified* on the basis of their accuracy, preferably by the use of a definitive method in the hands of two or more analysts.

Table 1. Uses of reference materials in measurement systems  
(based on table 17.1 in Taylor, 1987).

---

|   |
|---|
| <b>Method development and evaluation</b>                              |
| Verification and evaluation of precision and accuracy of test methods |
| Evaluation of field methods   |
| Validation of methods for a specific use                              |
| <b>Establishment of method traceability</b>                           |
| Development of secondary reference materials                          |
| Development of traceability protocols                                 |
| Direct field use  |
| <b>Assurance of measurement compatibility</b>                         |
| Direct calibration of methods and instrumentation                     |
| Internal (intralaboratory) quality assurance                          |
| External (interlaboratory) quality assurance                          |

---

It is clear therefore, that *certified reference materials* are needed to provide the basis for a successful long-term CO<sub>2</sub> program. Unfortunately, suitable reference materials do not exist presently for the measurement of each of the various parameters of the carbon dioxide system in sea water. Table 2 (overleaf) summarizes the present status of such reference materials: the individual measurements are discussed in more detail below. Such reference materials would preferably be stable for a period of at least 18 months. Values chosen in the specification "desired accuracy"<sup>†</sup> are based on considerations outlined in the report of SCOR Working Group 75 (SCOR, 1985). They reflect the desire to

---

<sup>†</sup> Considerable confusion exists between the terms *precision* and *accuracy*. Precision is a measure of how *reproducible* a particular experimental procedure is. It can refer either to a particular stage of the procedure, e.g. the final analysis, or to the entire procedure including sampling and sample handling. It is estimated by performing replicate experiments and estimating a mean and standard deviation from the results obtained. Accuracy, however, is a measure of the degree of agreement of a measured value with the "true" value. An accurate method is one capable of providing precise and unbiased results. It is a much more difficult quantity to estimate and can only be inferred by careful attention to possible sources of systematic error.

measure changes in the CO<sub>2</sub> content of sea water that will allow the increases due to the burning of fossil fuels to be observed.

Table 2. Present status of reference materials for the quality control of oceanic carbon dioxide measurements.

| analytical measurement           | desired accuracy                         | feasibility    | RM presently available? | planned availability        |
|----------------------------------|--|----------------|-------------------------|-----------------------------|
| total alkalinity                 | $\pm 1 \mu\text{mol}\cdot\text{kg}^{-1}$ | ✓              | ✗                       | July 1991 <sup>a</sup>      |
| total dissolved inorganic carbon | $\pm 1 \mu\text{mol}\cdot\text{kg}^{-1}$ | ✓              | ✓                       | January 1991 <sup>a,b</sup> |
| $f(\text{CO}_2)$                 | $\pm 0.05 \text{ Pa}$                    | ✗ <sup>c</sup> | ✗ <sup>c</sup>          | — <sup>c</sup>              |
| "pH" — $m^*(\text{H}^+)$         | $\pm 0.002$                              | ✓              | ✗ <sup>d</sup>          | —                           |

<sup>a</sup> These will be available from the Scripps Institution of Oceanography, U.S.A. (see Annexe II).

<sup>b</sup> Work is also currently in progress at the Institute of Ocean Sciences, Canada to develop such a reference material (see Annexe III).

<sup>c</sup> CO<sub>2</sub> in air reference materials are presently available through a variety of sources. However it is desirable to use a sterilized sea water sample as a reference material for a discrete  $f(\text{CO}_2)$  measurement. The feasibility of this is currently being examined at the Scripps Institution of Oceanography in collaboration with Dr. Chipman of the Lamont Doherty Geological Observatory.

<sup>d</sup> A suitable reference material would be a synthetic sea water containing an amine buffer such as 'tris' (2-amino-2-hydroxymethyl-1,3-propanediol). Although this can be prepared by any laboratory in accordance with a specified recipe, it is desirable to distribute certified batches from a central laboratory so that laboratories can confirm their ability to prepare the buffer correctly.

## THE CHEMISTRY OF CO<sub>2</sub> IN THE OCEANS

So as to make our subsequent discussion clearer and more self contained, we review here the current knowledge of the chemistry of the carbon dioxide system in sea water, and provide a detailed consideration of the methods used to analyze for the various parameters.

### Thermodynamic equations

The reactions which take place when carbon dioxide dissolves in water can be represented by the following series of equilibria:



In practice, it is usual to combine the concentrations of CO<sub>2</sub>(aq) and H<sub>2</sub>CO<sub>3</sub>, and to express this total as the concentration of a hypothetical species CO<sub>2</sub><sup>\*</sup>.

Reactions (1) and (2) are then redefined in terms of this species:

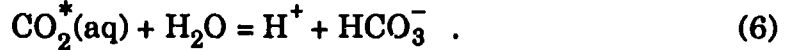

The equilibrium relationships between the concentrations of these various species can then be written as:

$$K_0 = [\text{CO}_2^*] / f(\text{CO}_2) \quad (7)$$

$$K_1 = [\text{H}^+][\text{HCO}_3^-] / [\text{CO}_2^*] \quad (8)$$

$$K_2 = [\text{H}^+][\text{CO}_3^{2-}] / [\text{HCO}_3^-] \quad (9)$$

where the brackets represent *total* concentrations of the individual enclosed chemical species, and  $f(\text{CO}_2)$  is the fugacity of carbon dioxide. Note that the fugacity of carbon dioxide is not the same as the partial pressure, *i.e.* the product of mole fraction and total pressure —  $x(\text{CO}_2)p$  — but rather takes account of the non-ideal nature of the gas phase (for more details consult a suitable textbook of thermodynamics, *e.g.* McGlashan, 1979). The magnitude of the difference is a function both of temperature and of gas phase composition (figure 3).

These various equilibrium constants are functions of the temperature, pressure, and the composition (salinity) of the solution (sea water), and have been measured on a variety of occasions. Interim recommendations of appropriate values for such constants have been published in a recent report (Unesco, 1987). More recent results (Goyet & Poisson, 1990; Dickson, unpublished work) are in agreement with these interim values.

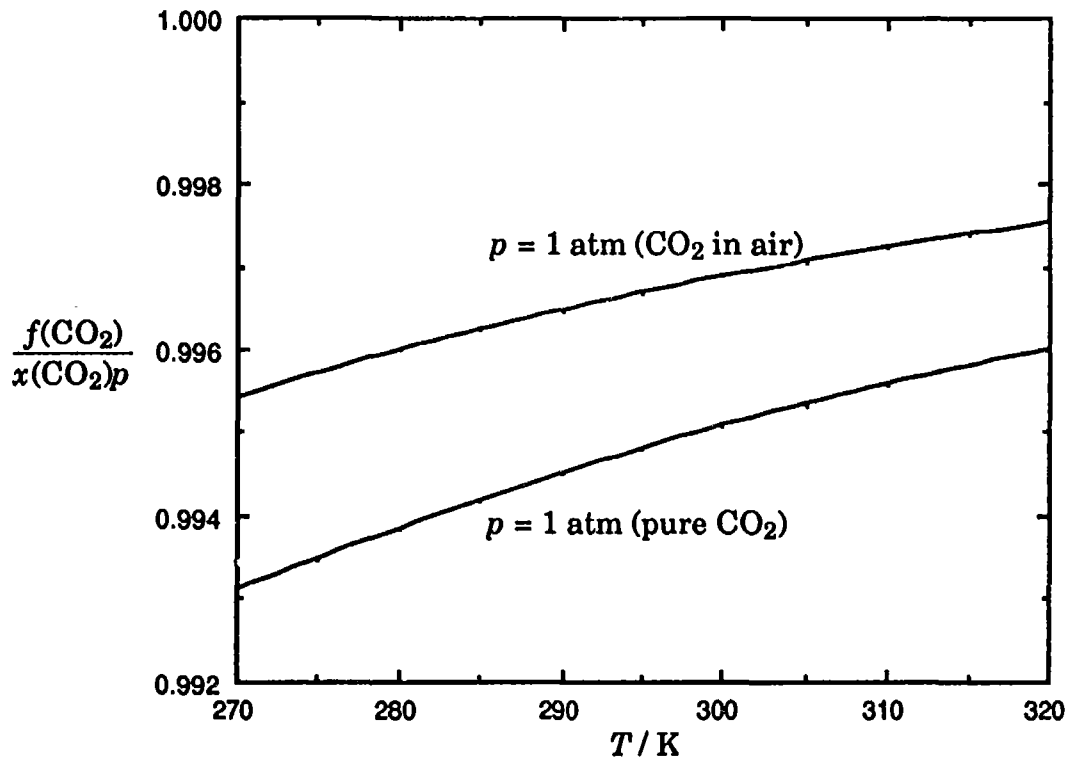

Figure 3. Variation of fugacity coefficient with temperature for pure CO<sub>2</sub>, and for CO<sub>2</sub> in air at mole fraction  $350 \times 10^{-6}$ .

### The analytical parameters of the CO<sub>2</sub> system in sea water

Unfortunately, the concentrations of the individual species in solution are not susceptible of direct measurement, although it is possible to design experiments which estimate values for  $f(\text{CO}_2)$ , and which measure a "pH" and thus  $[\text{H}^+]$ . The concentrations of the other constituents of this set of equations appear in two additional combinations which can be estimated from experimental measurements: the total dissolved inorganic carbon,

$$C_T = [\text{CO}_2^*] + [\text{HCO}_3^-] + [\text{CO}_3^{2-}] , \quad (10)$$

and the total alkalinity,

$$A_T = [\text{HCO}_3^-] + 2[\text{CO}_3^{2-}] + [\text{B}(\text{OH})_4^-] + [\text{OH}^-] + \dots - [\text{H}^+] - \dots, \quad (11)$$

where the ellipses stand for a variety of minor acid base species.† The number of linearly independent variables (i.e. the *rank* of this set of equations) is equal to the number of independent mass-conservation relationships plus the number of acid-base pairs considered. Although the rank is determined by the chemical description of the system, the particular choice of experimental variables remains at the discretion of the investigator. Typically the equilibrium constants,  $K_0$ ,  $K_1$ ,  $K_2$ , are measured carefully in the laboratory and used together with two or more of the following analytical parameters.

## ANALYTICAL METHODS IN CURRENT USE

### Total alkalinity, $A_T$

The total alkalinity of sea water,  $A_T$ , reflects the total amount of chemical bases present per kilogram of sample defined relative to a specified equivalence point (Dickson, 1981).  $A_T$  is determined using an acidimetric titration procedure, indeed this is the only reliable procedure known.

The earliest methods for equivalence-point determination used colorimetric pH indicators. The advent of the glass electrode, together with an understanding of the reactions taking place during the titration, gave rise to improved methods for determining this equivalence point. The first of these was the single point alkalinity method (Anderson and Robinson, 1946) which has been refined over the years (see *e.g.* Culberson *et al.*, 1970; Perez and Fraga, 1987). A complete titration method, based on the so-called "Gran plot" was developed by Dyrssen (Dyrssen, 1965; Dyrssen and Sillén, 1967). This approach was also used by Edmond (Edmond, 1970) and was incorporated, in a somewhat modified form, into the GEOSECS\* titration system used in the 1970s (Bradshaw *et al.*, 1981; Bos and Williams, 1982; Brewer *et al.*, 1986). Hansson and Jagner (1973) showed that it was possible to improve the accuracy of the standard Gran plot procedure by explicitly allowing for interfering side reactions such as the incomplete

---

† The total alkalinity of a sample of sea water is rigorously defined (Dickson, 1981) as: "...the number of moles of hydrogen ion equivalent to the excess of proton acceptors (bases formed from weak acids with a dissociation constant  $K \geq 10^{-4.5}$ , at 25 °C and zero ionic strength) over proton donors (acids with  $K < 10^{-4.5}$ ) in one kilogram of sample."

\* Geochemical Ocean Sections Study



reaction of  $\text{CO}_2$ , and the reactions of hydrogen ion with sulphate and fluoride. This "modified Gran procedure" has been used extensively by a number of groups to estimate both  $C_T$  and  $A_T$  in sea water from potentiometric titration data (Almgren *et al.*, 1977; Almgren *et al.*, 1983; Jones and Levy, 1981; Brewer *et al.*, 1986; Bradshaw and Brewer, 1988a; Bradshaw and Brewer, 1988b). The routine precision attainable with such titration techniques is  $\pm 2 \mu\text{mol}\cdot\text{kg}^{-1}$ .

A more rigorous calculation procedure uses a non-linear least-squares procedure to determine the alkalinity equivalence point (Dickson, 1981; Johansson and Wedborg, 1982; Barron *et al.*, 1983). Unlike the modified Gran procedure, which typically only uses data from the region past the  $\text{CO}_2$  equivalence point, this approach uses all the titration data to evaluate the alkalinity. As a result, it is perhaps more dependent on specifying the reactions that are occurring in solution correctly than is the modified Gran procedure.

Work is currently in progress in Dr. Dickson's laboratory at the Scripps Institution of Oceanography to develop a highly accurate analytical technique for  $A_T$  which is based on a coulometric approach developed at the U. S. National Bureau of Standards† to certify its primary standard acids and bases (Taylor and Smith, 1959). The approach is to add an excess of standard acid to a sample of sea water, and then to assay the excess acid coulometrically. Total charge (*i.e.* the integral of the electric current with time) can be measured extremely accurately. The accuracy and precision of this determination therefore depend almost entirely on the method used to locate the equivalence point. For more detail, see Annexe II.

### **Total dissolved inorganic carbon, $C_T$**

The most direct approach to measuring  $C_T$  involves acidifying a sea water sample to convert the  $\text{HCO}_3^-$  and  $\text{CO}_3^{2-}$  ions to undissociated  $\text{CO}_2$ , and then extracting this  $\text{CO}_2$  as a gas, trapping it, and measuring the amount evolved. Alternatively,  $C_T$  can, in principle, be determined from an acidimetric titration of sea water, although at present this approach is not believed to be particularly reliable. The principal methods in current use are detailed below:

*Extraction and manometric determination:* This procedure has been refined in Dr. Keeling's laboratory at the Scripps Institution of Oceanography over the years since the early work of Wong (1970). The sea water sample is acidified with phosphoric acid; the  $\text{CO}_2$  evolved is then extracted under vacuum and condensed in a trap cooled by liquid nitrogen. The water and  $\text{CO}_2$  are subsequently separated from one another by sublimation, and the  $\text{CO}_2$  is transferred into either a mercury column manometer or a quartz spiral manometer which is calibrated regularly against the mercury column manometer. There, the pressure, temperature, and volume of the  $\text{CO}_2$  are controlled and measured. The total amount of dissolved inorganic carbon in the original sample is calculated from an equation of state for  $\text{CO}_2$  gas.

---

† Now the National Institute for Standards and Technology, Gaithersburg, MD 20899, U.S.A.

***Extraction and coulometric determination:*** A description of the coulometric procedure for the analysis of  $C_T$  in sea water has been published by Johnson (Johnson *et al.*, 1985; Johnson and Sieburth, 1987). The technique is based on a method for determining  $CO_2$  described by Huffman (1977). The sea water sample is acidified and purged of  $CO_2$  by passing a stream of purified nitrogen (or helium) through the solution. The  $CO_2$  evolved is trapped from the gas stream into a proprietary absorbent which is believed to be a solution of 2-aminoethanol (ethanolamine) in a dimethyl-sulfoxide background containing some water and also an electrolyte (tetra-ethyl-ammonium bromide) together with a colorimetric acid-base indicator (thymolphthalein).

The  $CO_2$  is determined by means of a coulometric titration of the hydroxyethylcarbamic acid produced from the reaction of  $CO_2$  with the 2-aminoethanol. Hydroxide ion is generated by electrolysis of the water, and the total amount of hydroxide needed to maintain the absorbing solution at a constant, colorimetrically defined, pH is estimated by integrating the current with respect to time. This method is considerably more convenient than the vacuum extraction/manometric procedure, and it is possible to achieve a precision (standard deviation) of the order of  $1 \mu\text{mol}\cdot\text{kg}^{-1}$ . Preliminary results from a collaborative study (run by Dr. Dickson) indicate that some laboratories exhibit bias relative to values obtained using vacuum extraction / manometry. The extent of this bias varies from laboratory to laboratory, but is typically larger than the precision of measurement. Clearly more work is needed to identify and eliminate the sources of such biases.

***Determination from acidimetric titration data:*** The exact shape of a potentiometric titration curve depends explicitly on the value of  $C_T$ , as well as on the other acid-base species present. It is thus possible to evaluate  $C_T$  from titration data using either the "modified Gran procedure" (Hansson and Jagner, 1973) or a non-linear least-squares procedure (Dickson, 1981). Unfortunately, the accuracy with which  $C_T$  can be determined depends significantly on having a complete and accurate model for all the various acid-base processes in the sample, and there is some indication that the presence of an unidentified protolyte may cause systematic errors in the evaluation of  $C_T$  as high as  $20 \mu\text{mol}\cdot\text{kg}^{-1}$  (Brewer *et al.*, 1986; Bradshaw and Brewer, 1988a; Bradshaw and Brewer, 1988b).

### **The fugacity of $CO_2$ gas in equilibrium with sea water, $f(CO_2)$**

This is measured by equilibrating a sea water sample with air, and measuring the resultant mole fraction of  $CO_2$  in the air. The fugacity can then be calculated from a knowledge of the total pressure, together with an appropriate equation of state for  $CO_2$  in air (see discussion in Weiss, 1974). Two separate approaches have been taken to the equilibration process. In one approach (Weiss *et al.*, 1982), the open system approach, an essentially infinite amount of water is equilibrated with a approximately fixed amount of air at a controlled pressure: a sample of the air is then analyzed. In the closed system approach (*e.g.* Takahashi *et al.*, 1976; Takahashi *et al.*, 1982), a fixed amount of sea water is equilibrated

with a known volume of air at a controlled pressure, and corrections are made for the concomitant slight exchange of CO<sub>2</sub> with the water sample.

The measurement of the mole fraction of CO<sub>2</sub> in air can be carried out by a vacuum extraction / manometric procedure such as was described above for the estimation of C<sub>T</sub>. This is an extremely laborious process, and is only used when the highest precision and accuracy are needed (see *e.g.* Guenther, 1978). More typically, the carbon dioxide content of the equilibrated air is measured by infra-red analysis (*e.g.* Keeling *et al.*, 1965; Takahashi *et al.*, 1976), or by gas chromatography (*e.g.* Weiss, 1981; Weiss *et al.*, 1982). In either case, the instrument is calibrated with gas standards suitable for the measurement of CO<sub>2</sub> in air.

### The hydrogen ion concentration of sea water, pH<sup>†</sup>

The pH of a solution is usually defined in terms of measurements on the cell:

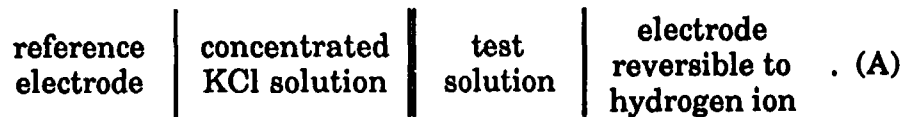

In the operational definition of pH (see Bates, 1973; I.U.P.A.C., 1979), the pH of solution X is related to the pH of standard S:

$$\text{pH}(\text{X}) = \text{pH}(\text{S}) + \frac{E_{\text{S}} - E_{\text{X}}}{(RT \ln 10 / F)} \quad . \quad (12)$$

The definitive method for pH measurement in *dilute* aqueous solutions depends on measuring the e.m.f. of the cell:

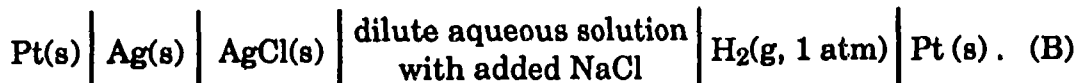

The calculated function is

$$\text{pH} = \lim_{m(\text{NaCl}) \rightarrow 0} \left\{ \frac{E^\circ - E}{RT \ln 10 / F} + \log m(\text{Cl}^-) + \log \gamma(\text{Cl}^-) \right\} \quad . \quad (13)$$

$E^\circ$  is the standard potential of the Ag/AgCl half cell (Bates and Bower, 1954; Dickson, 1987). The present convention (Bates and Guggenheim, 1960) is based on the assumption that the molal activity coefficient of chloride ion in dilute aqueous solution ( $I < 0.1 \text{ mol} \cdot \text{kg}^{-1}$ ) can be estimated by means of the equation

$$\log \gamma(\text{Cl}^-) = \frac{-A(I/m^\circ)^{1/2}}{1 + 1.5(I/m^\circ)^{1/2}} \quad , \quad (14)$$

where  $A$  is the usual temperature-dependent limiting Debye-Hückel slope and  $I$  is the ionic strength. This is essentially the procedure that has been used to determine the pH in a series of primary calibration standards, the so-called N.B.S. buffers (Bates, 1973).

† In this document, we use the term pH to mean the negative logarithm of the "total" hydrogen ion concentration on a sea water scale (Dickson, 1984; Dickson, 1990). Such a pH scale is compatible with the current recommended values of the equilibrium constants (Dickson & Millero, 1987; UNESCO, 1987).

Unfortunately, measurements based on dilute buffers are fraught with problems (see discussion in Dickson, 1984), it is thus desirable to define buffers based on synthetic sea water (Hansson, 1973a; Bates, 1975; Bates, 1982). Dr. Bates and co-workers at the University of Florida have published a series of papers detailing e.m.f. measurements on various nitrogen bases in synthetic sea water. They used the cell:

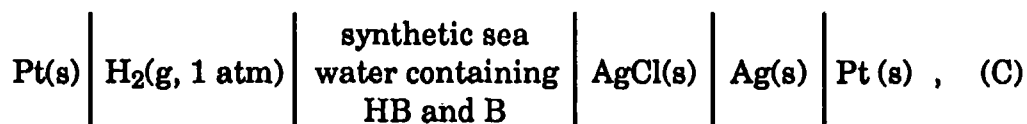

to study the acid dissociation of the hydrogen form of: 2-amino-2-hydroxymethyl-1,3-propanediol ("tris" — Ramette *et al.*, 1977); 2-amino-2-methyl-1,3-propanediol ("bis" — Bates and Calais, 1981); tetrahydro-1,4-isoxazine ("morpholine" — Czerminski *et al.*, 1982); 2-aminopyridine (Bates and Erickson, 1986). Note, these original papers interpret the reported potentials in terms of the "free" hydrogen ion concentration,  $m(\text{H}^+)$ , rather than as a "total" hydrogen ion concentration. Values of  $m^*(\text{H}^+)$  — the "total" hydrogen ion concentration can be calculated from these results (Dickson, in preparation). A precision of better than 0.003 pH units is achievable using such buffers.

pH measurements can also be made colorimetrically provided that the acid-base indicator has been appropriately calibrated. The basis of the spectrophotometric approach is the equation:

$$\text{pH} = \text{p}K'(\text{HB}) + \log \{m(\text{B})/m(\text{HB})\} , \quad (15)$$

where HB and B are the acid and base forms of the indicator. The effectiveness of this approach rests on the observation that the absorption spectra of the acid and base forms of the indicator are quite distinct. To measure the pH of a sea water sample using equation (15), two separate pieces of information are needed: the equilibrium constant  $K'(\text{HB})$ , which is a function of temperature and salinity, and the ratio  $\{m(\text{B})/m(\text{HB})\}$ , which can be obtained spectrophotometrically from measurements on the sample containing a small amount of indicator dye. Because of the sensitivity of the spectrophotometric measurement, the amount of indicator added to the sample does not perturb the pH, it is however necessary to thermostat the cell carefully because of the temperature sensitivity of  $K'(\text{HB})$  and of the extinction coefficients. At present, high precision measurements are made using a multi-wavelength technique (Byrne, 1987; Byrne and Breland, 1989); however, as yet this approach has not been as carefully calibrated as the electrometric approach.

## PREPARATION AND CERTIFICATION OF REFERENCE MATERIALS

Certified reference materials are clearly needed for the quality control of oceanic  $\text{CO}_2$  measurements. Without such reference materials, it is difficult for a single laboratory to be sure that its various analytical techniques are performing optimally, and the goal of consistent results with a minimum of between-laboratory bias, needed for large international programs such as the JGOFS, is

probably not achievable. It is imperative that a single laboratory be identified as having primary international responsibility for the preparation and distribution of suitable reference materials.

### **Sterilization, equilibration, and bottling of reference materials**

An important part of the production of reference materials based on natural sea water involves ensuring that the sea water used is sterile, and that it has been bottled in containers that assure its integrity. An example of a technique that has been used successfully for this is outlined in Annexe II.

### **Certification of reference materials for the various parameters**

A number of important factors need to be considered by any laboratory intending to certify reference materials for use in the study of the oceanic carbon dioxide system. These are:

- Each parameter certified in a reference material should be analyzed using a so-called definitive method which has been carefully investigated for possible bias. Such a method is of known accuracy, and is accepted to establish the property of a reference material and/or to evaluate the accuracy of other methodology (Taylor, 1987).
- The calibrations of any apparatus used in this definitive method should be traceable to nationally maintained "primary" standards.
- A carefully written standard operating procedure should exist for each analytical method used to certify the various reference materials.

In the following sections, we identify those methods we believe to be suitable for adoption as definitive methods, and indicate how their accuracy can be assessed.

#### ***Total alkalinity, $A_T$***

Total alkalinity is defined as the amount of acid required to titrate a sample of sea water to a specified equivalence point (Dickson, 1981). The key variables which control the accuracy of any appropriate approach are thus: the method used to locate the alkalinity equivalence point, the determination of the amount of solution titrated, the determination of the amount of acid required to reach the equivalence point, and the standardization of the acid titrant.

The coulometric back-titration method outlined above is potentially suitable for use as a definitive method. Both the mass of sample and the mass of acid added can be determined directly by weighing. The assay of the acid (both by itself, and after reaction with the alkalinity in the sea water sample) is done coulometrically, and the accuracy depends on the determination of the total charge passed. It is a fairly simple matter to measure current and time with sufficient accuracy (traceable to national standards) to integrate charge to within  $\pm 0.005\%$ . The key factor in the precision and accuracy of the overall method is the location of the equivalence point, both in the assay of the standard acid and in the determination of the amount of excess acid. The results to date (Dr. Dickson, work in progress) indicate a precision of about  $\pm 0.02\%$  (relative standard deviation) in the assay of acid with this method using a simple Gran plot to locate the equivalence point. However, use of a weighted non-linear curve fitting approach will improve the reliability of the location of the equivalence

point in sea water. Further experiments are needed to assess the overall accuracy of this determination by comparison with a completely independent approach: assaying the acid against pure silver (Analytical Chemists' Committee I.C.I., 1950; Woodward and Redman, 1973), and by analysis of the certified reference material "tris", available from the U. S. National Institute for Standards and Technology.

*Total dissolved inorganic carbon,  $C_T$*

The accuracy of the determination of  $C_T$  depends upon two factors: the complete stripping of the  $\text{CO}_2$  from a weighed sample of sea water, and the accurate determination of the amount of  $\text{CO}_2$  released. An appropriate definitive method for this analysis uses vacuum extraction of the carbon dioxide released from an acidified sample, separation of the  $\text{CO}_2$  from other gases and water vapour, and subsequent determination of the amount of  $\text{CO}_2$  by measuring its pressure, volume, and temperature and calculating the amount from an appropriate equation of state. As far as we are aware, only two laboratories are presently equipped to make measurements by this method: Dr. Keeling's laboratory at the Scripps Institution of Oceanography, La Jolla, California, and Dr. Wong's laboratory at the Institute of Ocean Sciences in Sidney, British Columbia. The standard deviation of this analysis on sea water samples is about  $0.7 \mu\text{mol}\cdot\text{kg}^{-1}$ .

This procedure is the simplest to relate to primary standards. The constant volume manometer at the Scripps Institution of Oceanography has a precision of 1 part in 4000 (Guenther and Keeling, 1986), and has been exhaustively calibrated in connection with measurements of atmospheric  $\text{CO}_2$ . As a more direct check, a series of assays of Ultrex<sup>®</sup> sodium carbonate have been made. The sodium carbonate was brought to constant weight following recommended procedures (Woodward & Redman, 1973). Each weighed carbonate sample was placed in the extraction apparatus routinely used for sea water samples. It was acidified with the same acid solution, and the  $\text{CO}_2$  evolved was then analyzed manometrically using the same manometric volumes as for sea water. The mean of 11 assays was  $100.05 \pm 0.05\%$ : *i.e.*, a systematic error of 1 part in 2000. The accuracy of the analysis is estimated to be within a factor of two of the precision.

*The fugacity of  $\text{CO}_2$  gas in equilibrium with sea water,  $f(\text{CO}_2)$*

The accuracy of the determination of  $f(\text{CO}_2)$  is dependent on two factors: the closeness to true equilibrium attained when equilibrating the air with the water sample at a controlled temperature (identical in each phase), and the accuracy of the subsequent analysis of the mole fraction of  $\text{CO}_2$  in the air sample. Some work needs to go into proving that a particular equilibration technique does indeed achieve thermodynamic equilibrium. This can be done by approaching the equilibrium both from above and from below; successful convergence of the two demonstrates that equilibrium has indeed been attained.

To calibrate the analytical technique, be it either gas chromatography or infra-red analysis, requires standards for  $\text{CO}_2$  in air with a mole fraction,  $x(\text{CO}_2)$ , of  $200\text{--}2000 \times 10^{-6}$ . Either the World Meteorological Organization (WMO) standards (maintained by Dr. Keeling's laboratory at the Scripps Institution of Oceanography) or the reference gases produced by the U.S. National Institute for

Standards and Technology are suitable as reference materials for this analysis. Unfortunately, neither of these organizations presently distributes a high CO<sub>2</sub> gas ( $x(\text{CO}_2) \geq 1000 \times 10^{-6}$ ). The Centre for Ocean Climatic Chemistry at the Institute of Ocean Sciences in Canada is equipped with a gravimetric system for synthesizing gas mixtures containing CO<sub>2</sub> (see Annexe III), and hopes in the future to be able to provide reference materials with values of  $x(\text{CO}_2)$  of up to  $2000 \times 10^{-6}$  (Dr. Wong, personal communication).

To certify a batch of sea water for  $f(\text{CO}_2)$  for use as a liquid reference material, it is desirable to assay the equilibrated air using the vacuum extraction / manometric technique (Keeling *et al.*, 1986; Guenther and Keeling, 1986) that was developed to calibrate the WMO standards. Again, checks will be needed to ensure that the air is in equilibrium with the water sample to within the desired level of accuracy.

#### *"Total" hydrogen ion concentration, pH*

Suitable reference materials are appropriate buffers in synthetic sea water. The values of pH assigned to these sea water buffers must correspond to the exact same pH scale used to define the various equilibrium constants such as  $K_1$  and  $K_2$ . We recommend that the pH be defined on a "total" or "sea water" scale (Hansson, 1973a; Dickson, 1984; Dickson, 1990) as this has been shown to be the most reproducible. The hydrogen electrode cell (C) used to assign pH values to the buffers is the same type of cell that is used to assign conventional pH values (see Bates, 1973).

Dr. Dickson (manuscript in preparation) has recently used the e.m.f. values reported by Bates and co-workers for a variety of amine bases: the hydrogen form of: 2-amino-2-hydroxymethyl-1,3-propanediol ("tris" — Ramette *et al.*, 1977); 2-amino-2-methyl-1,3-propanediol ("bis" — Bates and Calais, 1981); tetrahydro-1,4-isoxazine ("morpholine" — Czerminski *et al.*, 1982); 2-aminopyridine (Bates and Erickson, 1986), together with his published values for the standard potential of the reaction ( $\text{AgCl} + \frac{1}{2} \text{H}_2 = \text{Ag} + \text{HCl}$ ) in sea water (Dickson, 1990) to estimate values of  $K_m^*(\text{BH}^+)$  for the conjugate acids of these bases. This approach was used to assign pH values to equimolar buffer solutions composed of these various nitrogen bases, together with their conjugate acids. The values assigned have a precision of better than 0.002 pH units, and an estimated accuracy of better than 0.005 pH units. Such pH values are on the "total" hydrogen ion concentration scale (Dickson, 1990). These buffers can therefore be used as pH standards to make oceanic pH measurements consistent with the best available values for the acidity constants in sea water.

#### **Internal consistency of the chemical model for the CO<sub>2</sub> system**

An integral part of the assignment of certified values to standard reference materials is confidence in the *accuracy* of the values assigned. Although every effort must be made to assess the performance of laboratory measurements using reproducible primary standards, a further set of checks should be considered — the internal consistency of the chemical model for acid-base processes in sea water, and for the CO<sub>2</sub> system in particular. We mention some important examples here:

*C<sub>T</sub> from titration and from extraction*

In principle, it is feasible to obtain  $C_T$  as well as  $A_T$  from the processing of data from an acidimetric titration of sea water. Unfortunately, it does not seem possible to achieve this with adequate reliability at present. Nevertheless it is apparent that if the *correct* model of the various acid-base equilibria is used to interpret the titration data,  $C_T$  *should* be evaluated correctly. In addition, it is possible to measure  $C_T$  directly by acidifying the sample and extracting and measuring the  $\text{CO}_2$  produced. A comparison of these two results constitutes a sensitive check on the accuracy of the chemical model of the system. Indeed, at present, Bradshaw and Brewer (1988a; 1988b) have indicated that they believe the observed discrepancy between the titration derived value of  $C_T$  and that obtained by the acid extraction method may be due to the presence of unidentified bases in sea water (possibly organic in nature). It is important to account for such discrepancies.

*Internal consistency of a potentiometric titration*

A related check on the correctness of the chemical model of the acid-base processes in sea water is provided by a close examination of the results from each individual titration. The measurements comprise a set of pairs of values ( $V_i, E_i$ ), *i.e.* the volume of titrant added and the e.m.f. measured using an electrochemical cell sensitive to the concentration of hydrogen ion such as cell (A). At any point in the titration curve the measured e.m.f. is a function of the chemical state of the system:

$$E_i - E^\circ = \phi(T, V_i, V_0, C_T, A_T, K_1, K_2, \dots) \quad , \quad (17)$$

where  $E^\circ$  denotes a calibration constant,  $V_0$  the initial amount of sample,  $K_1$  and  $K_2$  the first and second dissociation constants of carbonic acid respectively, and the ellipsis second order correction terms for the other acid-base species present (such as  $\text{OH}^-$ ,  $\text{B}(\text{OH})_4^-$ , and  $\text{HPO}_4^{2-}$ ). If the model of the chemistry is correct, that is it includes all the appropriate species together with their concentrations and equilibrium constants, then the residuals ( $E_i^{\text{meas}} - E_i^{\text{calc}}$ ) will be randomly distributed. The degree of randomness constitutes a stringent check on the accuracy of the chemical model.

*Equilibrium constants*

An important part of our knowledge about the  $\text{CO}_2$  system in sea water is provided by measurements of the thermodynamic equilibrium constants. At present, the interim values for these constants (Unesco, 1987) come from the equations published by Weiss (1974) for  $K_0$  and by Dickson and Millero (1987) for  $K_1$  and  $K_2$ . More recently, Goyet and Poisson (1989) have made new measurements of  $K_1$  and  $K_2$ . As can be seen from figures 4 and 5, these new measurements are in good agreement with the earlier measurements (Hansson, 1973b; Mehrbach *et al.*, 1973) used by Dickson and Millero (1987). Although some discrepancies exist, it is certainly clear that at present,  $\text{p}K_1$  is known to  $\pm 0.01$  and  $\text{p}K_2$  is known to  $\pm 0.03$ . The agreement between the presently available values for  $\text{p}K_1$  and  $\text{p}K_2$  set limits to their reliability. Adjustments of the constants beyond these limits so as to fit field data should be discouraged!



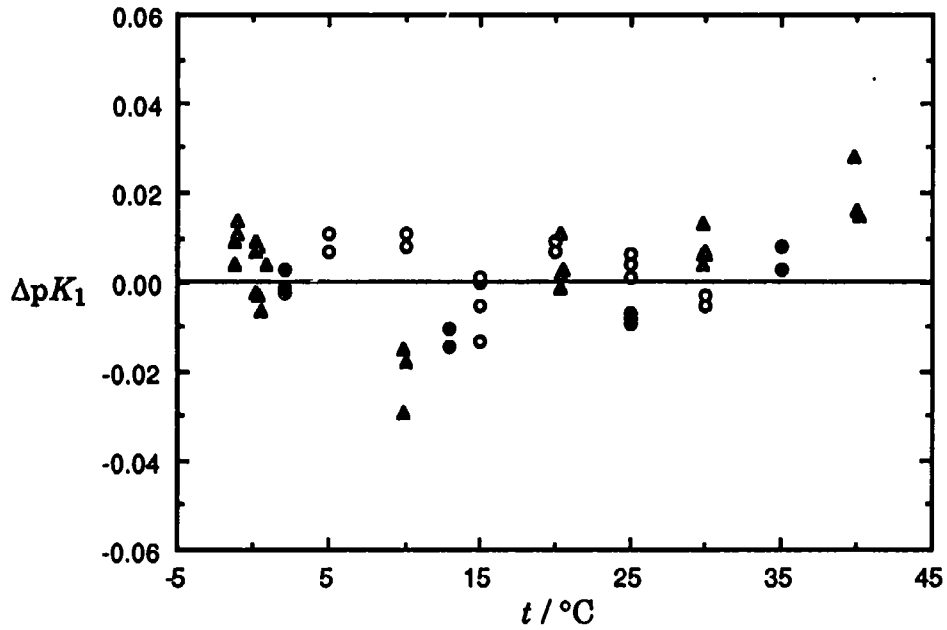

Figure 4. Scatter of measured  $pK_1$  values around the equation of Dickson and Millero (1987): • Mehrbach *et al.* (1973); ○ Hansson (1973b);  $\Delta$  Goyet & Poisson (1989).

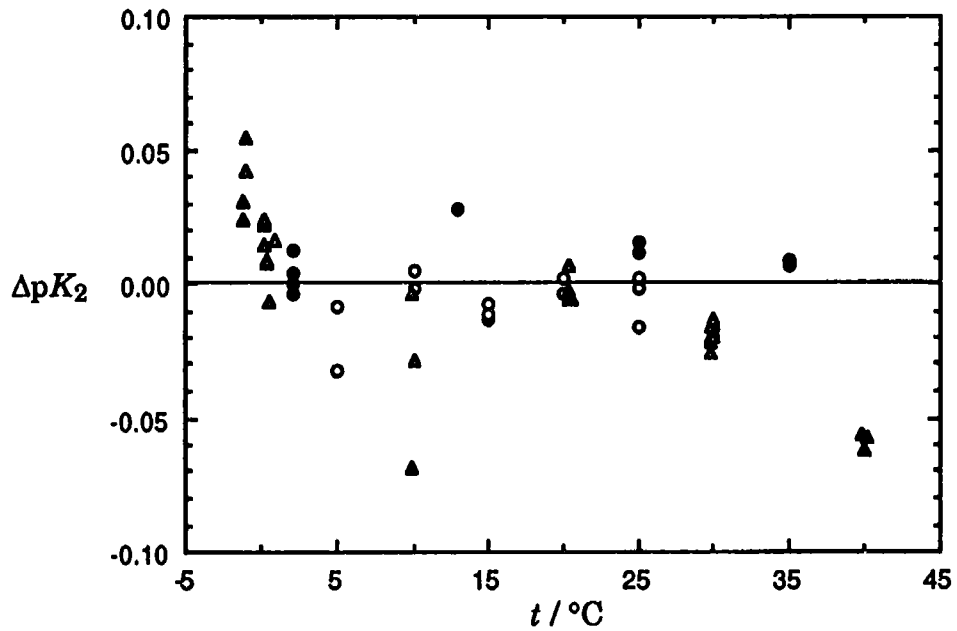
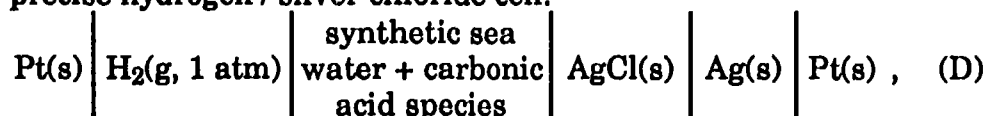

Figure 5. Scatter of measured  $pK_2$  values around the equation of Dickson and Millero (1987): • Mehrbach *et al.* (1973); ○ Hansson (1973b);  $\Delta$  Goyet & Poisson (1989).

New studies are presently in progress to determine  $pK_1$  and  $pK_2$  using the highly precise hydrogen / silver chloride cell:



Preliminary values for  $K_1$  agree with the measurements reported previously. These new results should provide values of  $pK_1$  valid to  $\pm 0.005$  and of  $pK_2$  to  $\pm 0.01$  from 0 to 45 °C and  $S = 0$  to 45.

Furthermore, it is possible to design an experiment based on making measurements of  $f(\text{CO}_2)$  at different values of  $C_T$ , and at a constant  $A_T$ , which can yield a value for  $K_0K_1/K_2$  so as to assess the accuracy of the proposed equilibrium constants (Guenther, 1978). As this is the quantity associated with the uptake of  $\text{CO}_2$  by the ocean, accurate measurements of this parameter would be extremely useful.

#### *Overdetermined systems*

The chemical thermodynamics of acid-base processes in sea water can be described by a set of equations based on mass-conservation expressions such as equation (10) given above for  $C_T$ , and on mass-action relationships for the various possible acid-base reactions. For example, equation (9) for the equilibrium constant  $K_2$  is the appropriate mass-action relationship for the acid-base reaction (4); one of various such equations for sea water. The number of linearly independent variables, the rank of this set of equations, is equal to the number of independent mass-conservation relationships plus the number of acid-base pairs considered. It is possible to design experiments where the number of independently measured quantities exceeds the rank of the set of equations, an "overdetermined" system.

Rearrangement of the various equations detailed above allows expressions to be derived which will express any of the various quantities desired in terms of alternate independent variables. These various possible combinations of observables are mathematically equivalent. However, because of the non-linear nature of the equations, the effect of an error in the measurement of the independent variables on the derived value of a parameter depends to a considerable extent on the particular equation used.

The redundancy implied by this makes it possible to check the accuracy of the various measured parameters. Typically, the three equilibrium constants are estimated from laboratory measurements, and only two or three analytical measurements are performed on any one sample – *e.g.*  $C_T$ ,  $A_T$ , and for surface samples  $f(\text{CO}_2)$ . If all three measurements are made, it should be possible to check if the agreement between calculated and measured values of  $f(\text{CO}_2)$  is within the error range to be expected from the errors on the independent variables. This check is essential to predicting the surface  $f(\text{CO}_2)$  from a circulation model which describes the distribution of  $C_T$ ,  $A_T$ , nutrients, and oxygen in the ocean (Peng *et al.*, 1987). At present, there are two potential sources of discrepancy: the equilibrium constants for the carbon dioxide system in sea water are not known accurately enough, and the exact interpretation of  $A_T$  may be in error because of the presence of unrecognized protolytic species. The

magnitude of such errors can, in the worst case, lead to errors of up to 10% in the predicted  $f(\text{CO}_2)$  at a particular location, thus destroying calculations of the net flux into and out of the ocean based on a circulation model. Additional experimental work is needed to assess and to resolve these discrepancies.

## **ANALYTICAL QUALITY CONTROL**

There are three important steps involved in establishing quality control for a measurement process:

- Documentation of a standard operating procedure.
- Demonstration that a measurement process is in "statistical control."
- Interlaboratory performance testing.

### **Standard operating procedures and the use of reference materials**

One clear barrier to obtaining consistent and accurate data from the world-wide community of investigators who are making measurements of the oceanic  $\text{CO}_2$  system is the lack of clear, well documented, standard operating procedures for the various analytical methods. Although such a task would seem to be in the purview of SCOR Working Group 75, it is clearly appropriate for this committee to endorse any such recommendations. In particular, there presently do not exist any documented protocols which outline the way in which reference materials should be used for quality control.

We also believe that it is important to recognize the difference between working standards, materials used to calibrate sea going instruments on a regular basis, and a reference material used as a means of performance assessment to determine that a particular analytical technique is "in control". If an instrument is continually recalibrated with the reference material, rather than with independent standards, it is no longer possible to check the quality of the data in a timely fashion.

A careful protocol needs to be worked out for each analytical method which allows the following: assessment of the long-term measurement precision, confirmation that the values assigned to calibration standards are consistent with the certified values of the reference material, and regular use of reference materials to provide quality assurance of the analytical measurements. (It may also be possible to use such information at a later date to harmonize data from different cruises if necessary.)

### **Demonstration of statistical control**

Repeated analysis of a reference material over an extended time period, plotting the results obtained as a control chart (Taylor, 1987), is the best way to demonstrate that a measurement process is in statistical control. An example of this approach is shown overleaf in figure 6. Here, samples of a prototype batch of reference material prepared by Dr. Dickson's laboratory were analyzed during the course of a cruise by staff from the NOAA Pacific Marine Environmental Laboratory in Seattle, Washington. The results could, in principle, have been

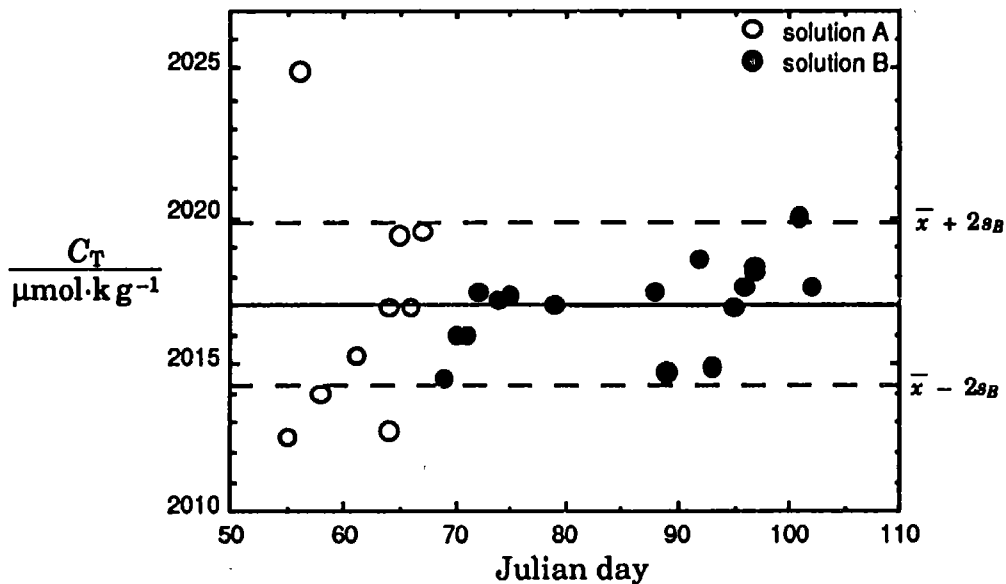

Figure 6. Control chart obtained by NOAA/PMEL during a cruise in 1990 (Dr. Feely, personal communication). The annotations, solution A and solution B refer to the use of different batches of coulometer solution. The standard deviation  $s_B$  was calculated from the results using solution B.

used to identify the existence of problems with coulometer solution batch A: unfortunately the chart was not prepared until after the cruise was complete.

It is apparent that the precision of the results is very good, particularly the precision of the results obtained with solution B ( $s_B = 1.4 \mu\text{mol}\cdot\text{kg}^{-1}$ ). Unfortunately, the mean result obtained ( $2017.0 \mu\text{mol}\cdot\text{kg}^{-1}$ ) is not in total agreement with measurements on the same batch of prototype reference material made in Dr. Keeling's laboratory at the Scripps Institution of Oceanography over a period of 9 months ( $2020.1 \pm 0.9 \mu\text{mol}\cdot\text{kg}^{-1}$ ). This degree of discrepancy is not unusual, and emphasizes the need for careful study to identify the reason for such differences.

#### Further intercalibration exercises

In the recent intercomparison exercise (Unesco, 1990) mentioned earlier in this report, the participants were asked to measure up to four parameters of the  $\text{CO}_2$  system on up to four samples, employing the methods that were in use in their laboratories. The laboratories involved were thus free to use whatever analytical method they felt was appropriate, and no standard operating procedures were prepared. No information was supplied by the participating laboratories indicating whether or not the analytical methods chosen were in statistical control. The results obtained (figures 1 and 2) are, however, probably a realistic assessment of the present state-of-the-art in  $\text{CO}_2$  measurements.

Clearly, more rigorous quality assurance is needed for measurements made as part of a global program involving, as it will, substantial numbers of different investigators over the years. Careful work will have to go into documenting the various procedures that are to be used, and demonstrating that they are indeed

capable of performing to the required levels of precision and accuracy. It is clear that the extent of the problems indicated by the 1988 exercise needs to be more carefully characterized, and that the reasons for the various discrepancies must be identified and eliminated before we can have full confidence in those measurements of the parameters of the CO<sub>2</sub> system that will be made as a part of JGCFs. Additional, carefully planned, intercalibration exercises will be needed as part of this quality assurance program.

It is thus instructive to consider the sequence of operations presented in table 3 (based on Wilson, 1979):

*Establishment of a working group.*

Careful co-ordination of all the work involved will be needed to ensure an efficient and uniform approach in all the participating laboratories throughout the stages of table 3. A single laboratory should be designated as the co-ordinating laboratory with responsibility for achieving this. The effectiveness of any quality control scheme depends ultimately on the competence of particular laboratories. Understanding and efficiency are improved when laboratories are party to decisions rather than having particular approaches forced on them. It is thus of value to establish a working group composed of a representative from each of the participating laboratories to plan and agree on both the general approach and also the detailed procedures for each determinand.

Table 3. Sequence of activities for analytical quality control  
(based on Wilson, 1979)

| <b>Activity</b>                           | <b>Purpose</b>   |
|---|--|
| Establish working group                   | To plan and co-ordinate all subsequent activities  |
| Define determinands and required accuracy | To ensure clear specification of analytical requirements   |
| Choose analytical methods                 | To select methods capable of the required accuracy   |
| Ensure unambiguous description of methods | To ensure that the chosen methods are properly followed  |
| Estimate within-laboratory precision      | To ensure that each laboratory achieves adequate precision   |
| Ensure accuracy of standard solutions     | To eliminate this source of bias in each laboratory  |
| Set up quality-control charts             | To maintain continuing check of precision in each laboratory   |
| Check between-laboratory bias             | To ensure that each laboratory achieves adequately small bias: tests to be repeated at regular intervals to maintain a continuing check on bias. |

### *Definition of determinands and required accuracy*

In the context of the study of the CO<sub>2</sub> system in sea water, the appropriate determinands are total alkalinity, total dissolved inorganic carbon,  $f(\text{CO}_2)$ , and pH. Suggestions for the desired accuracy were made by Working Group 75 of SCOR in a report some years ago (SCOR, 1985). This report called for an accuracy comparable to the "state-of-the-art" measurement ability: great care will be needed to achieve such accuracy on a regular basis.

### *Choice of analytical methods*

The procedures which are presently in use have been described briefly in an earlier section. It would be best to select those methods that are most convenient and accurate in routine use, and then to persuade the various measurement groups to use them.

### *Written descriptions of analytical methods*

Virtually all publications concerned with analytical quality control stress the importance of detailed written descriptions of analytical methods. At present, published descriptions do not exist for any of the methods mentioned above, although Dr. Wong, chairman of SCOR working group 75, is preparing some of these methods for a manual in the SCOR methodology series. The U. S. Department of Energy CO<sub>2</sub> survey science team is also in the process of preparing a handbook of the methods in use in their program.

### *Ensuring adequate within-laboratory precision*

As it is the precision of routine results that is desired, tests should be spread over a long time period rather than made on a limited number of occasions. Precision can be assessed from replicate results for a given sample; these results should be independent of one another. It is essential that the determinand concentration in the sample be the same each time it is analyzed.

### *Calibration solutions and gases*

As far as is possible, the materials used for calibration in each laboratory should be checked to ensure that they have been accurately prepared. It is essential that this source of potential bias be removed before any intercalibration exercise can be successful. Ideally, a central source of appropriate standards could be used, though it is more practical to rely on intralaboratory calibration standards. These standards could be exchanged between laboratories for collaborative checks.

### *Quality control charts*

Each laboratory should be using quality control charts as a technique to help maintain and check the precision of their analyses. This requires some suitable reference material which can be used for replicate analysis.

### *Intercalibration exercise*

Once all these preconditions have been fulfilled, it will be appropriate to embark on a further intercalibration exercise to check the extent of between-laboratory bias. Such an intercalibration should be an ongoing procedure aimed at maintaining a continuing check on bias.

Taylor (1987) states:

“There is a natural aversion to regulations and requirements, even when they merely describe what is ordinarily done. When regulations include trivia or incredible requirements, they not only discredit the important ones, but also engender contempt for the whole program. Accordingly, the quality assurance program must be both realistic and perceived to be such.”

This is the central issue, we need to work together to develop such a program.

## PROGRESS TO DATE

At our meeting in Acapulco, the sub-panel made the recommendations detailed in table 4. These recommendations were presented to the SCOR general meeting, and were accepted as being a necessary prerequisite to the collection of extensive, reliable, oceanic carbon data. Since that time there have been a number of developments.

Table 4. Recommendations presented to the SCOR general meeting in Acapulco, 1988

- 
1. That standards be available for  $C_T$  and  $A_T$  by July of 1990.
  2. These standards should be used by those workers involved in the global  $CO_2$  programs to provide strict data quality control of long term and large scale field  $CO_2$  observational programs.
  3. To achieve the proposed target date (July 1990) we recommend that SCOR and other international oceanographic committees endorse the concept of using standard reference materials for the global  $CO_2$  programs.
  4. Funds should be secured by the appropriate global programs to set up a mechanism to bottle and distribute these standards. They will be certified jointly by selected standard laboratories.
- 

Two laboratories have been working towards the preparation of reference materials: the laboratory of Dr. Dickson at the Scripps Institution of Oceanography where research to develop suitable reference materials has been funded by the U. S. National Science Foundation as part of the work for the U.S. JGOFS, and Dr. Wong's laboratory at the Centre for Ocean Climatic Chemistry of the Institute for Ocean Sciences, British Columbia, Canada, supported by the PERD (panel on energy research and development) committee of the Canadian federal government, as a component of the Canadian oceanic  $CO_2$  measurement program. The achievements of these two laboratories are detailed in annexes to this report.

The collection of oceanic carbon data constitutes a component of JGOFS, and a portion of such measurements will be made during the WOCE† Hydrographic

---

† World Ocean Circulation Experiment

Program under the auspices of the U. S. Department of Energy (Special Research Grant Program 89-7A: Global survey of carbon dioxide in the oceans). The U. S. Department of Energy recently (July 1990) solicited proposals from various U. S. laboratories for the preparation of such reference materials for use with their program. As a result of this solicitation, an interim reference material will be available in limited quantities from Dr. Dickson's laboratory in January 1991.

The U. S. Department of Energy sees the provision of certified reference materials as a clear priority for their survey of carbon dioxide in the oceans, and has undertaken to provide reference materials in reasonable amounts to scientists internationally who are involved in making measurements on the WOCE Hydrographic Program, as well as to U. S. NOAA investigators, and to investigators making measurements at the JGOFS time-series stations (Dr. M. Riches, letter to Dr. Dickson).

It is still a matter of some priority to persuade all scientists involved in making any of these four measurements — $C_T$ ,  $A_T$ ,  $f(\text{CO}_2)$ , pH— to concern themselves with the problem of quality control. We believe that the availability of internationally recognized reference materials will play an important role in this, and feel that the recommendations outlined below should be pursued vigorously.

## RECOMMENDATIONS OF THE SUB-PANEL

There is a recognized need for extensive geographical and seasonal coverage of carbon dioxide measurements in the oceans of the world. The measurements presently planned will take several years to complete, and we anticipate that some time-series studies may continue indefinitely so as to document longer period changes in the earth's biogeochemical cycles, and their influence on the climate. In view of this, the JPOTS sub-panel on standards for  $\text{CO}_2$  measurements proposes the following recommendations:

### 1. Development, distribution, and use of reference materials

Reference materials certified to the following accuracies must be developed, prepared, distributed, and *used* internationally.

| analytical measurement                                       | desired accuracy                         |
|--|--|
| total alkalinity   | $\pm 1 \mu\text{mol}\cdot\text{kg}^{-1}$ |
| total dissolved inorganic carbon                             | $\pm 1 \mu\text{mol}\cdot\text{kg}^{-1}$ |
| fugacity of $\text{CO}_2$ in equilibrium with a water sample | $\pm 0.05 \text{ Pa}$                    |
| total concentration of hydrogen ion, "pH"                    | $\pm 0.002$                              |

### 2. Recognition of a primary international producer

A single facility should be formally recognized as the primary international producer and distributor of reference materials so as to ensure a reliable and consistent supply of reference materials to the international scientific



community. In the event that additional facilities are set up to fulfil the international requirements for reference materials, it is essential that they work closely together with this primary facility.

**3. Certification of reference materials**

The certification values assigned to reference materials should be confirmed wherever possible by measurements in two or more independent laboratories using definitive methods.

**4. Demonstration of thermodynamic consistency**

Measurements should be undertaken to demonstrate that the values obtained in both field and laboratory measurements of the various CO<sub>2</sub> parameters, are thermodynamically consistent with a complete chemical model for acid/base processes in sea water.

**5. Handbook of standard methods**

A handbook of carefully written "standard operating procedures" detailing tested and reliable methods for each of the various CO<sub>2</sub> parameters should be prepared. This is required to help ensure that measurements of the various CO<sub>2</sub> parameters made by different laboratories are consistent with each other. These written procedures must emphasize the use of reference materials to assure and to assess data quality.

**6. Oversight group**

An international group of experts, including members of potential producing and certifying laboratories, should be charged with the responsibility to implement these recommendations as quickly as possible.

A detailed discussion of the scientific basis for these recommendations, together with an indication of the current progress, is presented in the body of the report of the sub-panel.

Dr. F. Culkin

Dr. A. G. Dickson (*chairman*)

Dr. F. J. Millero

Dr. A. Poisson

Dr. C. S. Wong

**BIBLIOGRAPHY**

- Almgren T., D. Dyrssen & S. Fonselius (1983) Determination of alkalinity and total carbonate. In: *Methods of seawater analysis*, K. Grasshoff, M. Ehrhardt and K. Kremling, editors, Verlag Chemie, Weinheim, 99–123.
- Almgren T., D. Dyrssen & M. Strandberg (1977) Computerized high precision-titrations of some major constituents of sea water on board R/V *Dmitry Mendeleev*. *Deep-Sea Research* **24**, 345–364.
- Analytical Chemists' Committee I.C.I. (1950) The standardisation of volumetric solutions. *The Analyst* **75**, 577–604.
- Anderson D. H. & R. J. Robinson (1946) Rapid electrometric determination of the alkalinity of sea water using a glass electrode. *Industrial and Engineering Chemistry, Anal. Edition* **18**, 767–769.
- Barron J. L., D. Dyrssen, E. P. Jones & M. Wedborg (1983) A comparison of computer methods to calculate alkalinity and total carbonate from potentiometric titrations of seawater. *Deep-Sea Research* **30**, 441–448.
- Bates R. G. (1973) *Determination of pH, theory and practice*, Wiley-Interscience, New York, 479 pp.
- Bates R. G. (1975) pH scales for sea water. In: *The Nature of Seawater*, E. D. Goldberg, editor, 313–338.
- Bates R. G. (1982) pH measurements in the marine environment. *Pure & Applied Chemistry* **54**, 229–232.
- Bates R. G. & V. E. Bower (1954) Standard potential of the silver-silver-chloride electrode from 0° to 95° C and the thermodynamic properties of dilute hydrochloric acid solutions. *Journal of Research of the National Bureau of Standards* **53**, 283–290.
- Bates R. G. & J. G. Calais (1981) Thermodynamics of the dissociation of BisH<sup>+</sup> in seawater from 5 to 40 °C. *Journal of Solution Chemistry* **10**, 269–279.
- Bates R. G. & W. P. Erickson (1986) Thermodynamics of the dissociation of 2-aminopyridinium ion in synthetic seawater and a standard for pH in marine systems. *Journal of Solution Chemistry* **15**, 891–901.
- Bates R. G. & E. A. Guggenheim (1960) Report on the standardization of pH and related terminology. *Pure and Applied Chemistry* **1**, 163–168.
- Bos D. & R. Williams (1982) History and development of the GEOSECS alkalinity titration system. U.S. Department of Energy. CONF-7911173.
- Bradshaw A. L. & P. G. Brewer (1988a) High precision measurements of alkalinity and total carbon dioxide in seawater by potentiometric titration — 1. Presence of unknown protolyte(s)? *Marine Chemistry* **23**, 69–86.
- Bradshaw A. L. & P. G. Brewer (1988b) High precision measurements of alkalinity and total carbon dioxide in seawater by potentiometric titration. 2. Measurements on standard solutions. *Marine Chemistry* **24**, 155–162.

- Bradshaw A. L., P. G. Brewer, D. K. Shafer & R. T. Williams (1981) Measurements of total carbon dioxide and alkalinity by potentiometric titration in the GEOSECS program. *Earth and Planetary Science Letters* **55**, 99–115.
- Brewer P. G., A. L. Bradshaw & R. T. Williams (1986) Measurements of total carbon dioxide and alkalinity in the North Atlantic Ocean in 1981. In: *The changing carbon cycle. A global analysis*, J. R. Trabalka and D. E. Reichle, editors, Springer-Verlag, New York, 348–370.
- Byrne R. H. (1987) Standardization of standard buffers by visible spectrometry. *Analytical Chemistry* **59**, 1479–1481.
- Byrne R. H. & J. A. Breland (1989) High precision multiwavelength pH determinations in seawater using cresol red. *Deep-Sea Research* **36**, 803–810.
- Culberson C., R. M. Pytkowicz & J. E. Hawley (1970) Seawater alkalinity determination by the pH method. *Journal of Marine Research* **28**, 15–21.
- Czerminski J. B., A. G. Dickson & R. G. Bates (1982) Thermodynamics of the dissociation of morpholinium ion in seawater from 5 to 40°C. *Journal of Solution Chemistry* **11**, 79–89.
- Dickson A. G. (1981) An exact definition of total alkalinity and a procedure for the estimation of alkalinity and total inorganic carbon from titration data. *Deep-Sea Research* **28A**, 609–623.
- Dickson A. G. (1984) pH scales and proton-transfer reactions in saline media such as sea water. *Geochimica et Cosmochimica Acta* **48**, 2299–2308.
- Dickson A. G. (1987) Standardization of the  $(\text{AgCl} + \frac{1}{2}\text{H}_2 = \text{Ag} + \text{HCl})$  cell from 273.15 to 318.15 K. *Journal of Chemical Thermodynamics* **19**, 993–1000.
- Dickson A. G. (1990) Standard potential of the  $(\text{AgCl}(\text{s}) + \frac{1}{2}\text{H}_2(\text{g}) = \text{Ag}(\text{s}) + \text{HCl}(\text{aq}))$  cell and the dissociation constant of bisulfate ion in synthetic sea water from 273.15 to 318.15 K. *Journal of Chemical Thermodynamics* **22**, 113–127.
- Dickson A. G., Total hydrogen ion concentration pH buffers and acidity constants for ammonia and various amine bases in sea water. (in preparation)
- Dickson A. G. & F. J. Millero (1987) A comparison of the equilibrium constants for the dissociation of carbonic acid in seawater media. *Deep-Sea Research* **34**, 1733–1743.
- Dyrssen D. (1965) A Gran titration aboard *Sagitta*. *Acta Chemica Scandinavica* **19**, 1265.
- Dyrssen D. & L. G. Sillén (1967) Alkalinity and total carbonate in sea water. A plea for p-T independent data. *Tellus* **19**, 113–121.
- Edmond J. M. (1970) High precision determination of titration alkalinity and total carbon dioxide content of sea water by potentiometric titration. *Deep-Sea Research* **17**, 737–750.
- Goyet C. & A. Poisson (1989) New determination of carbonic acid dissociation constants in seawater as a function of temperature and salinity. *Deep-Sea Research* **36**, 1635–1654.

- Guenther P. R. (1978) Laboratory report: seawater equilibration experiment no. 3. Scripps Institution of Oceanography. SIO Ref. 78-14.
- Guenther P. R. & C. D. Keeling (1986) Addendum: Scripps reference gas calibration system for carbon dioxide-in-nitrogen and carbon dioxide-in-air standards: results of the manometric volume reanalysis of 1986. Central CO<sub>2</sub> Laboratory of the WMO.
- Hansson I. (1973a) A new set of pH scales and standard buffers for sea water. *Deep-Sea Research* **20**, 479-491.
- Hansson I. (1973b) The determination of the dissociation constants of carbonic acid in synthetic sea water in the salinity range of 20 - 40‰ and temperature range of 5 - 30 °C. *Acta Chemica Scandinavica* **27**, 931-944.
- Hansson I. & D. Jagner (1973) Evaluation of the accuracy of Gran plots by means of computer calculations. Application to the potentiometric titration of the total alkalinity and carbonate content of sea water. *Analytica Chimica Acta* **65**, 363-372.
- Huffman E. W. D. Jr. (1977) Performance of a new automatic carbon dioxide coulometer. *Microchemical Journal* **22**, 567-573.
- I.U.P.A.C. (1979) Manual of symbols and terminology for physicochemical quantities and units. *Pure & Applied Chemistry* **51**, 1-41.
- Johansson O. & M. Wedborg (1982) On the evaluation of potentiometric titrations of seawater with hydrochloric acid. *Oceanologica Acta* **5**, 209-218.
- Johnson K. M., A. E. King & J. M. Sieburth (1985) Coulometric TCO<sub>2</sub> analyses for marine studies; An introduction. *Marine Chemistry* **16**, 61-82.
- Johnson K. M. & J. M. Sieburth (1987) Coulometric total carbon dioxide analysis for marine studies: Automation and calibration. *Marine Chemistry* **21**, 117-133.
- Jones E. P. & E. M. Levy (1981) Oceanic CO<sub>2</sub> increase in Baffin Bay. *Journal of Marine Research* **39**, 405-416.
- Keeling, C. D., N. W. Rakestraw & L. S. Waterman (1965) Carbon dioxide in the surface waters of the Pacific Ocean 1. Measurement of the distribution. *Journal of Geophysical Research* **70**, 6087-6097.
- Keeling C. D., P. R. Guenther & D. J. Moss (1986) Scripps reference gas calibration system for carbon dioxide-in-air standards: Revision of 1985. Central CO<sub>2</sub> Laboratory of the World Meteorological Organization. WMO/TD-No. 125.
- McGlashan, M. L. (1979) *Chemical Thermodynamics*. Academic Press, London, 345 pp.
- Mehrbach C., C. H. Culberson, J. E. Hawley & R. M. Pytkowicz (1973) Measurement of the apparent dissociation constants of carbonic acid in seawater at atmospheric pressure. *Limnology and Oceanography* **18**, 897-907.

- N.S.F. (1987) A unified plan for ocean science. A long range plan for the division of ocean sciences of the National Science Foundation. National Science Foundation.
- Peng T.-H., T. Takahashi, W. S. Broecker & J. Olafsson (1987) Seasonal variability of carbon dioxide, nutrients and oxygen in the northern North Atlantic surface water: observations and a model. *Tellus* **39B**, 439–458.
- Perez F. F. & F. Fraga (1987) A precise and rapid analytical procedure for alkalinity determination. *Marine Chemistry* **21**, 169–182.
- Poisson, A., F. Culkin & P. Ridout (1990) Intercomparison of CO<sub>2</sub> measurements. *Deep-Sea Research*, **37**, 1647–1650.
- Ramette R. W., C. H. Culberson & R. G. Bates (1977) Acid-base properties of tris(hydroxymethyl)aminomethane (tris) buffers in seawater from 5 to 40 °C. *Analytical Chemistry* **49**, 867–870.
- SCOR (1985) Oceanic CO<sub>2</sub> measurements. Report of the third meeting of the Working Group 75, Les Houches, France, October 1985.
- SCOR (1988) Report of the second session for the SCOR committee for JGOFS. The Hague, September 1988. JGOFS Report 1.
- Takahashi T., D. Chipman, N. Schechtman, J. Goddard & R. Wanninkof (1982) Measurements of the partial pressure of CO<sub>2</sub> in discrete water samples during the North Atlantic Expedition, the Transient Tracers of Oceans Project. Lamont-Doherty Geological Observatory. Technical Report to NSF
- Takahashi T., P. Kaiteris & W. S. Broecker (1976) A method for shipboard measurement of CO<sub>2</sub> partial pressure in seawater. *Earth and Planetary Science Letters* **32**, 451–457.
- Taylor J. K. (1987) *Quality assurance of chemical measurements*, Lewis Publishers, Inc., 328 pp.
- Taylor J. K. & S. W. Smith (1959) Precise coulometric titration of acids and bases. *Journal of Research of the National Bureau of Standards—A. Physics and Chemistry* **63A**, 153–159.
- Unesco (1987) Thermodynamics of the carbon dioxide system in seawater. Report by the carbon dioxide sub-panel of the joint panel on oceanographic tables and standards. Unesco technical papers in marine science 51.
- Unesco (1990) Intercomparison of total alkalinity and total inorganic carbon determinations in sea water. Unesco technical papers in marine science 59.
- Weiss R. F. (1974) Carbon dioxide in water and seawater: the solubility of a non-ideal gas. *Marine Chemistry* **2**, 203–215.
- Weiss R. F. (1981) Determinations of carbon dioxide and methane by dual catalyst flame ionization chromatography and nitrous oxide by electron capture chromatography. *Journal of Chromatographic Science* **19**, 611–616.
- Weiss R. F., R. A. Jahnke & C. D. Keeling (1982) Seasonal effects of temperature and salinity on the partial pressure of carbon dioxide in seawater. *Nature* **300**, 511–513.

- Wilson A. L. (1979) Approach for achieving comparable analytical results from a number of laboratories. *The Analyst* 104, 273–289.
- Wong C. S. (1970) Quantitative analysis of total carbon dioxide in sea water: A new extraction method. *Deep-Sea Research* 17, 9–17.
- Woodward C. & H. N. Redman (1973) *High-precision titrimetry*, The Society for Analytical Chemistry, London, 63 pp.

## ANNEXE I

Reprinted with permission from *Deep Sea Research*, Vol. 37, No. 10; A. Poisson, F. Culkin and P. Ridout, Intercomparison of CO<sub>2</sub> Measurements; © 1990, Pergamon Press PLC.

*Deep-Sea Research*, Vol. 37, No. 10, pp. 1647-1650, 1990.  
Printed in Great Britain.

0198-0149/90 \$3 00 + 0.00  
Pergamon Press plc

## FORUM

Intercomparison of CO<sub>2</sub> measurements

A. POISSON,\* F. CULKIN† and P. RIDOUT‡

(Received 7 December 1989; in revised form 19 April 1990; accepted 21 May 1990)

**Abstract**—Seawater samples, of four different salinities, were analysed for total alkalinity, total CO<sub>2</sub>, pH and *p*CO<sub>2</sub> by up to 12 laboratories. The results show that although most laboratories are capable of high precision in these determinations, there is an unacceptably high disagreement between their analyses of the same samples. For global programmes involving studies of the CO<sub>2</sub> system in seawater, it is strongly recommended that standard reference materials be made widely available.

## INTRODUCTION

CONCERN OVER the effect of increased levels of carbon dioxide in the atmosphere has led to studies of the carbon dioxide system in seawater being included in international oceanographic programmes such as the Joint Global Ocean Flux Study (JGOFS) and the World Ocean Circulation Experiment (WOCE). For the success of these studies, it is essential that measurements by different workers from different laboratories, using a variety of techniques, be both comparable and accurate. In principle, the species distribution of carbon dioxide in seawater can be calculated from any two of the following parameters: total alkalinity (*TA*), total CO<sub>2</sub> (*TCO*<sub>2</sub>), pH and partial pressure of CO<sub>2</sub> (*p*CO<sub>2</sub>), together with the appropriate thermodynamic data. Although methods capable of high precision are available for the determination of these parameters, their accuracy, as distinct from precision, depends on a number of factors that can produce discrepancies between determinations by different laboratories. The extent and causes of such inter-laboratory discrepancies have, as yet, not been fully investigated and it is desirable that they be considered well in advance of the commencement of major programmes.

In 1987, the Joint Panel on Oceanographic Tables and Standards (JPOTS) sub-panel on standards for CO<sub>2</sub> measurements endorsed an intercomparison exercise initiated by the ICES Marine Chemistry Working Group and the SCOR Working Group 75 on methodology for oceanic carbon measurements, the aim of which was to assess the reliability of data on *TA*, *TCO*<sub>2</sub> and, if possible, pH and *p*CO<sub>2</sub> in seawater, as determined by

\*Laboratoire de Physique et Chimie Marines, Université Pierre et Marie Curie, Tour 24-25, 4 Place Jussieu, 75252 Paris, Cedex 05, France.

†Institute of Oceanographic Sciences, Deacon Laboratory, Wormley, Godalming, Surrey GU8 5UB, U.K.

‡Ocean Scientific International Ltd, Brook Road, Wormley, Godalming, Surrey GU8 5UB, U.K.

laboratories engaged in programmes related to the CO<sub>2</sub> problem. This paper presents the results of this exercise involving 12 laboratories and a comparison of their data.

#### INTERCOMPARISON EXERCISE

An earlier investigation (GOYET *et al.*, 1985) of the suitability of IAPSO Standard Seawater, as a reference standard for alkalinity determinations, showed significant variations between ampoules from the same batch, which suggested that the glass from which the ampoules were made was not of a suitable quality. An investigation was therefore carried out into the suitability of Pyrex bottles for the storage of intercalibration samples which were prepared at the IAPSO Standard Seawater Service. It was concluded from these preliminary tests that seawater samples prepared and stored in Pyrex bottles sealed with ground glass stoppers, greased with Apiezon and held in position with metal clips were satisfactory for a TA intercomparison exercise but that the bulk samples should be equilibrated with air at a temperature of at least 25°C during preparation to be adequate for TCO<sub>2</sub>, pH and pCO<sub>2</sub>.

Four samples of seawater of salinities *ca* 8, 30, 35 and 38, each equilibrated with air at 26°C, were prepared by the IAPSO Standard Seawater Service. Each of the 12 participating laboratories was supplied with at least two samples of each salinity and requested to carry out as many of the four determinations as possible.

As part of the exercise, one laboratory carried out determinations of TA, TCO<sub>2</sub> and pH on 12 bottles of seawater salinity 35. The results of these determinations showed no significant changes with storage time or bottle order (POISSON *et al.*, 1990).

#### RESULTS AND DISCUSSION

##### *Total alkalinity*

Results obtained by potentiometric titration were calculated, assuming zero concentrations of phosphate and silicate. If the data from two laboratories, whose results are very far from the mean of the others, are not taken into account, the overall scatter in the measurements is 14 (2.6%), 28 (1.5%), 31 (1.4%) and 26 (1.1%)  $\mu$  eq kg<sup>-1</sup> for salinities 8, 30, 35 and 38, respectively. Taking the mean values from the same laboratories the maximum differences are 13, 20, 21 and 24  $\mu$  eq kg<sup>-1</sup>, respectively, for the four salinities, equivalent to 2.5, 1.0, 0.9 and 1.0% of the measured values, which is about 5–10 times reproducibility of the individual laboratories.

##### *Total CO<sub>2</sub>*

The data show clearly that the two techniques most widely used for the determination of total CO<sub>2</sub>—potentiometry and acidification followed by extraction—give significantly different results, the potentiometric results being consistently higher than those obtained by extraction. This confirms the findings of BRADSHAW and BREWER (1988), who suggested the presence in seawater of an unknown protolyte that can masquerade as CO<sub>2</sub> in the titration method. The scatter of the potentiometric data is of the same order as that of the extraction data, suggesting standardization problems.

The maximum difference between the mean values of TCO<sub>2</sub> obtained by each labora-



tory using potentiometry as 1.3 (0.3%), 15 (0.8%), 16 (0.8%) and 18 (0.8%)  $\mu\text{mol kg}^{-1}$  for salinities 8, 30, 35 and 38; the corresponding difference obtained by extraction is 5 (1%), 28 (1.6%), 22 (1.1%) and 31.5 (1.4%)  $\mu\text{mol kg}^{-1}$ . The standard deviation of the mean value of the laboratories'  $\text{TCO}_2$  obtained by potentiometry is 0.2, 0.4, 0.4 and 0.4%, respectively, for salinities 8, 30, 35 and 38, and 0.5, 0.6, 0.5 and 0.6% for  $\text{TCO}_2$  obtained by extraction.

These discrepancies are significantly greater than accepted individual precision, as was found with the alkalinity determinations.

### pH

Four laboratories made direct determinations, using NBS buffers, one made direct determinations using TRIS buffers and one determined pH on total proton scale from the first potential of the samples during the potentiometric titration of  $\text{TA}$  and  $\text{TCO}_2$ . Results from the direct determinations using TRIS buffers consistently agreed to within 0.02–0.03 units with those obtained by potentiometric titration. The scatter in the results, based on the NBS scale, was much greater (0.3 units), however, and confirms the problems associated with the use of these buffers pointed out in Unesco (1983).

It is difficult to draw any firm conclusions from these limited data, except that the scatter in results from different laboratories, apparently using the same techniques, is much greater than the reproducibility/standard deviation claimed by the individual laboratories.

### $p\text{CO}_2$

Only three laboratories measured  $p\text{CO}_2$ , all at different temperatures. The data were corrected to  $p\text{CO}_2$  (25°C) using the thermodynamic relationships between  $\text{TA}$ ,  $\text{TCO}_2$  and  $p\text{CO}_2$  for salinity  $S$ , temperature  $t$  (°C) and the dissociation constants for carbonic acid recommended by the JPOTS Carbon Dioxide Sub-Group (UNESCO, 1983). The maximum difference of the data (50, 25, 10 and 15  $\mu\text{atm}$  for salinities 8, 30, 35 and 38, respectively) was much greater than the standard deviations of the individual laboratories. It is noticeable that for each of the four data sets, the mean data of two laboratories agreed closely but, unfortunately, the agreement was not always between the same two laboratories.

### SUMMARY

The intercomparison exercise has shown considerable disagreement between laboratories in their analyses of  $\text{TA}$ ,  $\text{TCO}_2$ , pH and  $p\text{CO}_2$  in seawater, although most of the individual laboratories are capable of high precision in their measurements. Even excluding the results from two laboratories, the maximum differences in  $\text{TA}$  were 14, 28, 31 and 26  $\mu\text{eq kg}^{-1}$  for seawaters of salinity 8, 30, 35 and 38, respectively. For a salinity of 35, this is equivalent to more than 1% of the measured value, whereas most laboratories would claim a coefficient of variation of 0.1–0.2%. These figures compare unfavourably with the stated desired accuracy of 1  $\mu\text{eq kg}^{-1}$  (0.05% of the measured value) for the JGOFS and WOCE programmes.

For  $\text{TCO}_2$ , at least some of the scatter appears to be due to the method of determination. As has been reported previously, the potentiometric titration gives results which are

consistently higher than those obtained by extraction techniques, though the scatter in the data from the two techniques is about the same.

The pH data showed that results on the NBS scale were higher than those on the TRIS scale, which confirms the trend found in the preliminary storage tests. For more comparable pH determinations, therefore, there is a standardization problem.

The limited  $p\text{CO}_2$  data showed that two of the three participating laboratories agreed well for each of the samples but the pairings were not always the same. It seems likely that the disagreements were due, in part, to differences in technique such as measurement of  $p\text{CO}_2$  in the phase or equilibration between gas and liquid phases.

The present situation, therefore, is that it is not yet possible for different laboratories, even those experienced in these measurements, to produce comparable and accurate data on  $TA$ ,  $\text{TCO}_2$  pH and  $p\text{CO}_2$  in seawater. There is a clear need for standard reference materials, preferably certified by two laboratories, to be made available for all workers involved in global  $\text{CO}_2$  programmes. This intercomparison exercise has shown that it is possible to prepare and store suitable standards which are stable for at least 15 months but to prepare them on a scale sufficient to meet the needs of JGOFS and WOCE necessitates long-term planning and allocation of funds.

*Acknowledgements*—Thanks are due to A. Bradshaw, P. Brewer and C. T. Chen for participating in the preliminary tests and to all the other participants. The authors are grateful to S. Morcos for his continued interest and support in this exercise. This work was supported by UNESCO (contract SC/RP/236007.6) and CNRS (contract AIP 85-0693). A financial support from C. T. Chen is also gratefully acknowledged.

#### REFERENCES

- BRADSHAW A. L. and P. G. BREWER (1988) High precision measurements of alkalinity and total carbon dioxide in seawater by potentiometric titration: I. Presence of unknown protolyte(s)? *Marine Chemistry*, **23**, 69–86.
- GOYET C., A. POISSON, C. BRUNET and F. CULKIN (1985) IAPSO Standard Seawater as a reference standard for alkalinity determinations. *Deep-Sea Research*, **32**, 1437–1443.
- POISSON A., F. CULKIN and P. RIDOUR (1990) Intercomparison of total alkalinity and total inorganic carbon determinations in seawater. *Unesco Technical papers in Marine Sciences*, **59**, 69 pp.
- UNESCO (1983) Carbon dioxide sub-group of Joint Panel on Oceanographic Tables and Standards Report of meeting in Miami, Florida, 21–23 September 1981. *Unesco Technical Papers in Marine Science*, **42**, 25 pp.

## ANNEXE II

WORK IN PROGRESS AT THE SCRIPPS INSTITUTION OF OCEANOGRAPHY, U. S. A.

A. G. Dickson

**Sterilization and bottling of sea water based reference materials**

The apparatus depicted in figure II.1 has been developed in my laboratory at the Scripps Institution of Oceanography.<sup>†</sup> It is used to sterilize sea water, to equilibrate it with a controlled fugacity of carbon dioxide, and to deliver it for bottling.

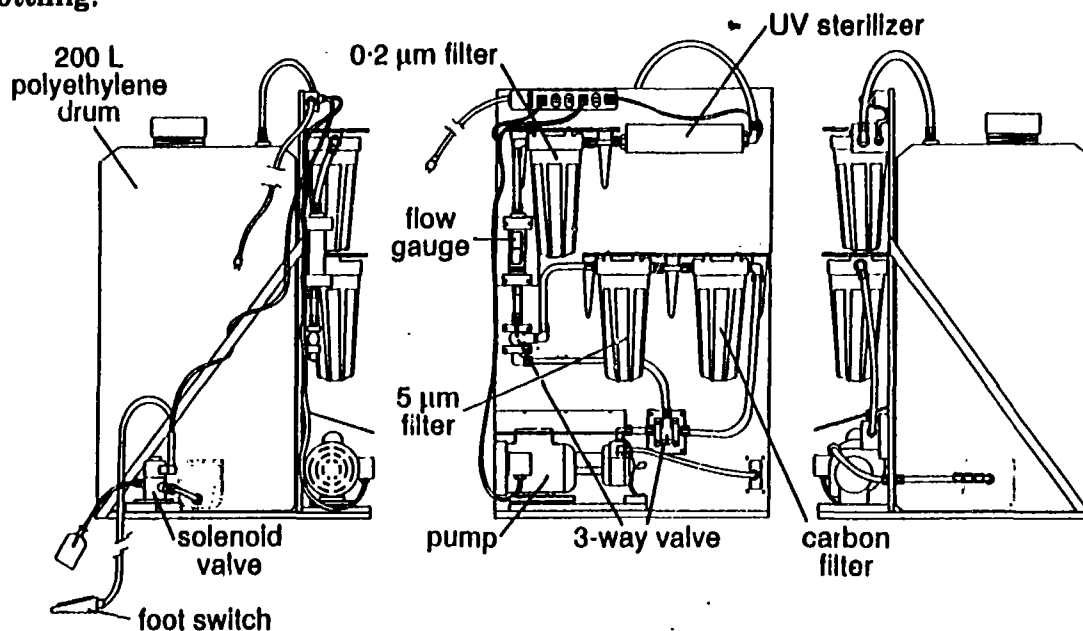

Figure II.1: Apparatus used at the Scripps Institution of Oceanography for sterilizing and bottling liquid reference materials.

Raw sea water is pumped initially into the polyethylene holding tank through a carbon filter (to reduce the organic content of the water), a 5 µm filter, a 0.2 µm filter, and an ultra-violet flow-through sterilizing unit. Once the holding tank is full (capacity about 0.22 m<sup>3</sup>), a saturated solution of mercuric chloride is added as a biocide (*ca.* 25 cm<sup>3</sup>), and the water is recirculated for a period of about 48 hours through the 0.2 µm filter and the ultra-violet sterilizer.

The water returns to the holding tank by showering through the head-space, and air is pumped through this head-space using an aquarium pump to ensure that the water is equilibrated at the atmospheric value of  $f(\text{CO}_2)$ . This equilibration can change the amount of dissolved inorganic carbon in accordance with the reaction:



The reason for equilibrating with the atmospheric  $f(\text{CO}_2)$  is to minimize the extent of transfer of carbon dioxide to or from the atmosphere that occurs when

<sup>†</sup> Research funded by the U.S. National Science Foundation, Division of Ocean Sciences.

containers of reference material are either filled or used. Bottles are filled by gravity feed directly from the holding tank, and the flow is controlled by a solenoid valve operated by a foot switch.

At present, batches of prototype reference material are bottled in 500 cm<sup>3</sup> containers made of Schott Duran glass. Glass similar to this has been found by experience in Dr. Keeling's laboratory at the Scripps Institution of Oceanography to be suitable for the long-term storage of sea water for the measurement of alkalinity and dissolved inorganic carbon. The chemical and physical properties of this glass are outlined in table II.1. Although other glasses and containers are under investigation, at present we believe this glass to be an appropriate, conservative, choice.

Table II.1. Chemical and physical properties of Schott Duran glass

| <i>Composition</i>                   |                         |
|--------------------------------------|-------------------------|
| SiO <sub>2</sub>                     | 81 %                    |
| B <sub>2</sub> O <sub>3</sub>        | 13 %                    |
| Na <sub>2</sub> O + K <sub>2</sub> O | 4 %                     |
| Al <sub>2</sub> O <sub>3</sub>       | 2 %                     |
| l.c.e.† / K <sup>-1</sup>            | 32.5 × 10 <sup>-7</sup> |
| ρ / g·cm <sup>-3</sup>               | 2.23                    |

† linear coefficient of expansion

### Stability of C<sub>T</sub> in the reference material

The total dissolved inorganic carbon in batches of the reference material is analyzed by researchers in Dr. Keeling's laboratory at the Scripps Institution of Oceanography using the definitive extraction / manometric technique described in the body of this report. Results from Batch 1 are shown in figure II.2.

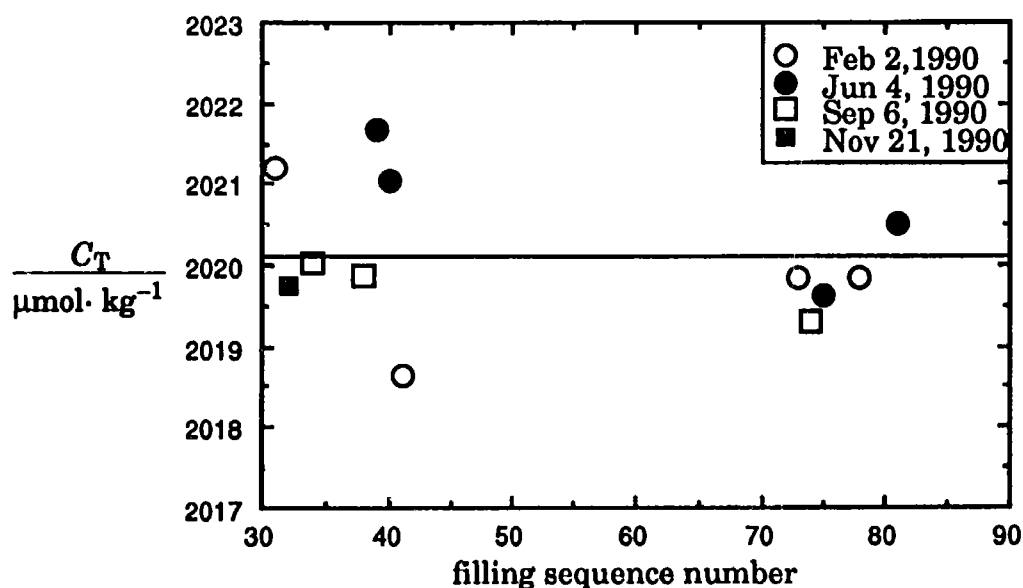

Figure II.2. Plot of the values of total dissolved inorganic carbon obtained by analyzing bottles from Batch 1 (bottled on Jan 29, 1990). Analyses were made on four separate occasions over a period of over 9 months.

It is clear that the total dissolved inorganic carbon in the sterilized sea water is stable, indeed the standard deviation ( $0.85 \mu\text{mol}\cdot\text{kg}^{-1}$ ) computed from these results is comparable with that for the method itself ( $0.7 \mu\text{mol}\cdot\text{kg}^{-1}$ ). Furthermore, there is no indication of a trend with filling sequence, suggesting that the bottling procedure is suitable, and that essentially identical bottles are being produced.

### Development of a definitive method for determining total alkalinity

We are in the process of developing a highly accurate, definitive, procedure for the determination of total alkalinity. Our approach is based on the coulometric procedure used at the U. S. National Institute for Standards and Technology to certify primary standard acids and bases. An excess of standard acid is added to a sample of sea water, and the excess acid determined coulometrically. The total charge equivalent to the excess acid can be measured extremely accurately, and hence the accuracy and the precision of the method depend almost entirely on the approach used to locate the end-point.

The system used to generate and measure a constant current is depicted in figure II.3. The current is adjusted to the approximate desired value while running through the adjustable resistor, it is then switched to run through the cell for a known time. Current flowing through the cell is sensed by circuitry used to activate a quartz timer, switching it on when current starts to flow and off when it stops, thus allowing an extremely accurate measurement of the time during which the current is flowing. The current itself is measured throughout the titration by repeatedly reading the voltage across a high accuracy standard resistor,  $R_s$ , and calculating the average current passing during the titration step. The whole operation is controlled from a Macintosh computer over an

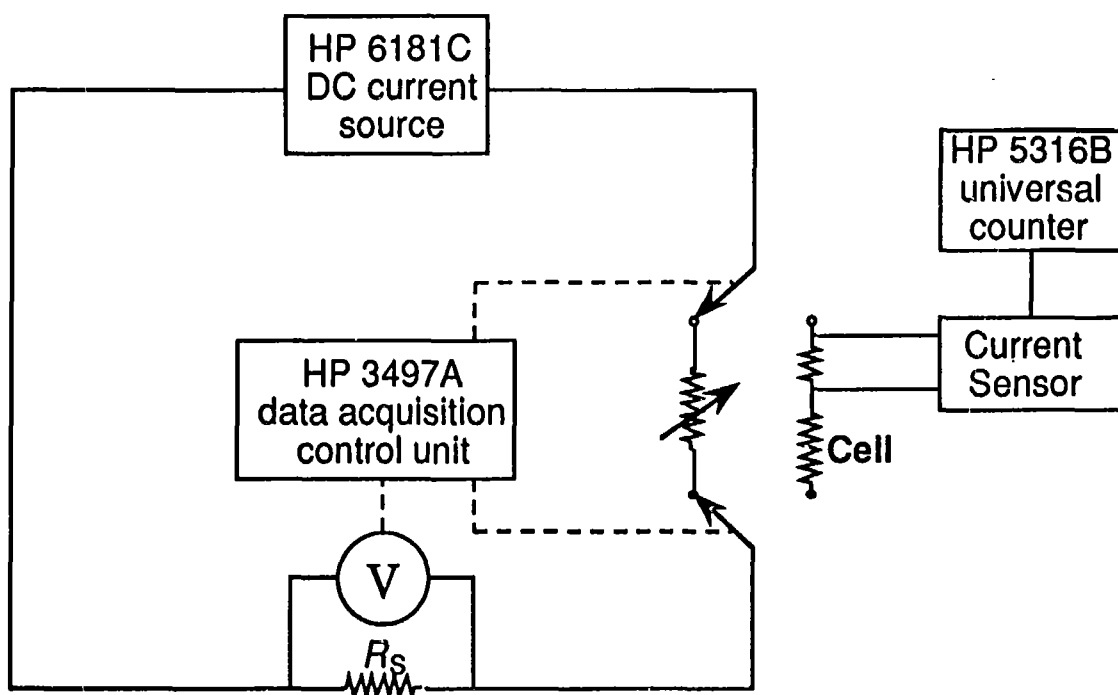

Figure II.3. Block diagram of coulometric titration system.

IEEE-488 interface. This system provides accurate values of the total charge passed in the individual titration steps ( $\pm 0.002\%$ ).

This high accuracy constant current system is coupled with a cell design (figure II.4) which has been shown to be suitable for high precision coulometry, to provide the complete coulometric titration system.

Initial results are encouraging, we have achieved a precision of measurement of better than  $0.02\%$  (relative standard deviation), and have demonstrated that the accuracy of this approach is within  $0.05\%$ . Further work with this method, refining our techniques of manipulating the sample, indicates that these figures can be improved on, and we are presently pursuing this.

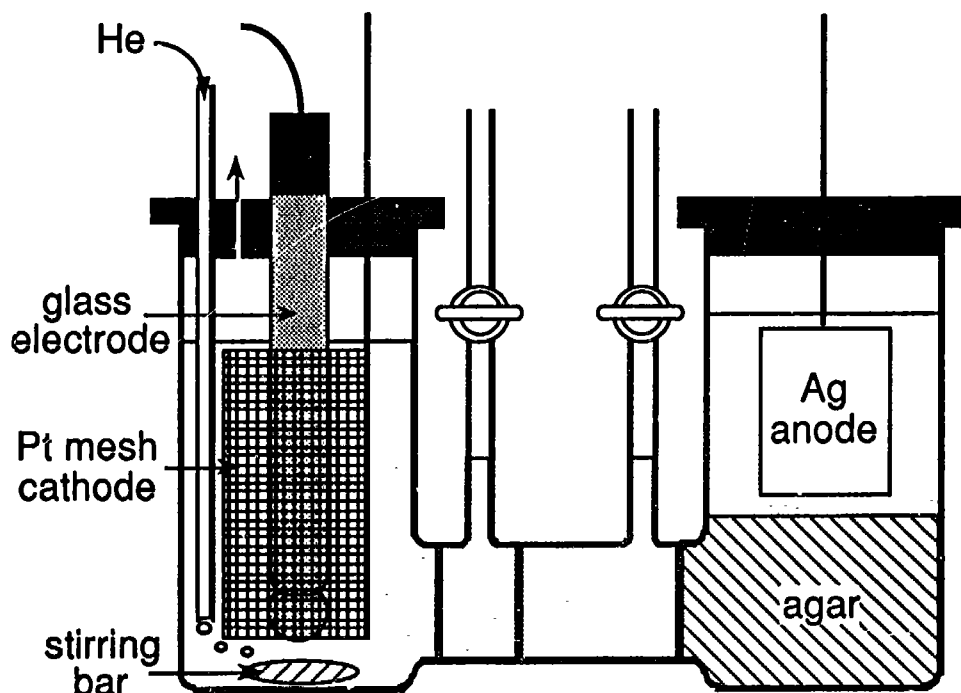

Figure III.4 Coulometric titration cell

### Distribution of reference materials

My laboratory is presently responsible for distributing interim reference materials certified for total dissolved inorganic carbon to investigators in the U. S. that are funded by the U. S. Department of Energy as part of its Special Research Grant Program 89-7A: Global survey of carbon dioxide in the oceans. We expect to continue in this role, and to expand our capacity to supply other U. S. investigators, as well as investigators in countries outside the U. S. who are engaged in  $\text{CO}_2$  measurements as part of the JGOFS  $\text{CO}_2$  survey.

### Collaborative studies

We have recently (October 1990) initiated a collaborative study of the extraction / coulometric approach to measuring total dissolved inorganic carbon in sea water. A batch of reference material was bottled, and twenty bottles containing identical samples of sea water were sent to each of fourteen different

laboratories for analysis. The laboratories were asked to analyze these bottles in pairs, no more than one pair each day using the procedure in current use in their laboratory. The background value and the calibration factor will thus be determined separately for each pair of analyses. This set of results can be used to assess whether or not the data from a particular laboratory are in a state of statistical control, while at the same time providing an estimate of the reproducibility of the method. Furthermore, this study will provide a preliminary estimate of the extent of between-laboratory bias, and may give clues as to its source.

At present, preliminary results from 5 of the participating laboratories are very encouraging. The typical standard deviation of analysis is only slightly greater than  $1 \mu\text{mol}\cdot\text{kg}^{-1}$ , and the spread of results is about  $6 \mu\text{mol}\cdot\text{kg}^{-1}$ .

### **Future work**

We expect to continue our efforts to produce reference materials for the analysis of the oceanic carbon dioxide system, distributing reference materials that have been certified for total dissolved inorganic carbon and for total alkalinity. We also hope to examine, in the next few years, whether or not it is feasible to certify our sea water reference material for  $f(\text{CO}_2)$  and for pH.

## ANNEXE III

### WORK IN PROGRESS AT THE INSTITUTE FOR OCEAN SCIENCES, CANADA

C. S. Wong

#### Introduction

The Canadian program on oceanic CO<sub>2</sub> standards is being carried out at the Centre for Ocean Climatic Chemistry (COCC) of the Institute of Ocean Sciences (IOS) at Sidney, B. C., Canada. The standards laboratory provides CO<sub>2</sub> standards and long-term calibrations for the CO<sub>2</sub> monitoring and global survey activities funded both by the Department of Fisheries and Oceans (DFO) and by the Panel of Energy Research and Development (PERD). Present and future activities requiring CO<sub>2</sub> analytical quality assurance include:

1. Atmospheric CO<sub>2</sub> measurements: marine atmospheric CO<sub>2</sub> observations will be made on ships of opportunity, and using Canadian and USSR research ships for air-sea CO<sub>2</sub> flux studies; Arctic time-series station in Siberia.
2. Oceanic CO<sub>2</sub> monitoring at Ocean Station P (50°N, 145°W) and Line P, and on Chevron tanker routes in the N. E. Pacific Ocean.
3. Global CO<sub>2</sub> surveys: Canadian WOCE line P-15 in the Pacific (1994) to be undertaken by IOS and lines A-1 and A-2 in the Atlantic (1992) by the Bedford Institute of Oceanography (BIO). The CO<sub>2</sub> parameters to be measured are: total dissolved inorganic carbon, total alkalinity, and fugacity of CO<sub>2</sub> in equilibrium with sea water. There will be Canada/USSR joint cruises in the N. Pacific under the repeat hydrography program of WOCE covering areas enclosed by lines P-1 and P-2.

There has been some ground work, particularly building up our facilities over the past few years. More intensive work is expected to start in April 1991 under the Canadian governmental Green Plan. The progress of the work is described below.

#### Gaseous CO<sub>2</sub> standards

The COCC gravimetric system consists of: (a) a high precision VOLAND® optical read-out balance, Model HCE 10, with a capacity of 10 kg readable to 1.0 mg, *i.e.* a capacity to sensitivity ratio of 10 million to one, (b) a high capacity ultra-precision balance, Model HCE 100, with a 100 kg capacity and a sensitivity of 10 mg, *i.e.* the same capacity to sensitivity ratio as in (a), and (c) a high pressure gas blending system (figure III.1). The blending system, including the removable stainless steel cylinder, is evacuated, filled with pure CO<sub>2</sub>, and the amount of CO<sub>2</sub> in the cylinder found by the difference in weight using the HCE10 balance. The gas is then flushed into the target cylinder to high pressure using either CO<sub>2</sub> free air or nitrogen, and the final concentration in the target cylinder is controlled by weighing on the HCE100 balance. The system has been used to prepare a CO<sub>2</sub> in air mixture with  $x(\text{CO}_2)$  of about  $400 \times 10^{-6}$  for  $f(\text{CO}_2)$  measurements and for coulometric pneumatic gas.



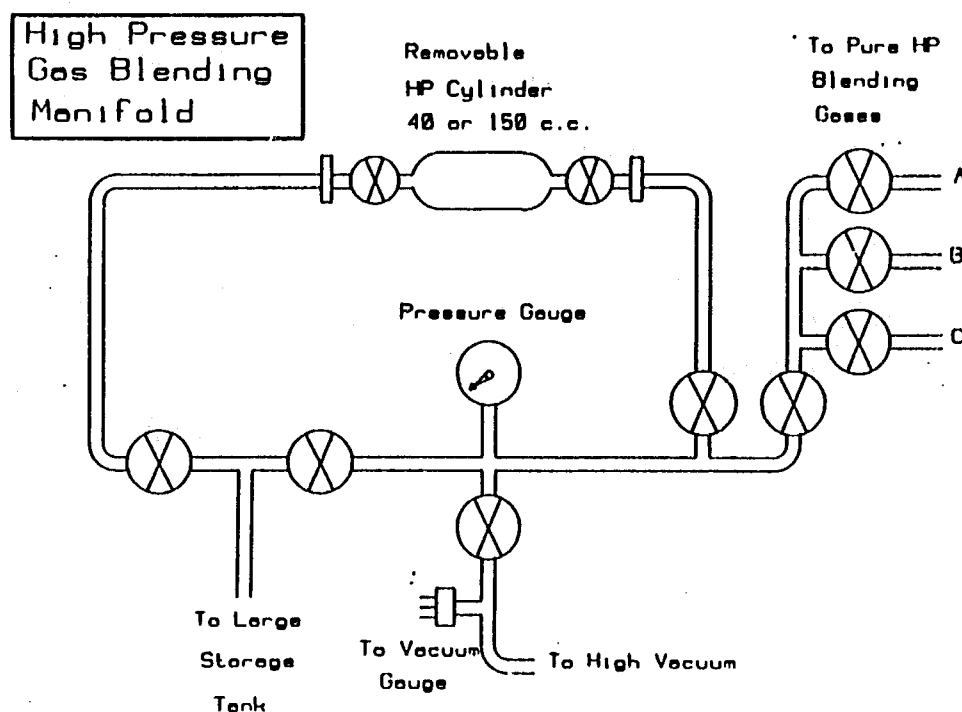

Figure III.1: High-pressure gas blending system.

The system will be used for preparing gas mixtures of  $\text{CO}_2$  in air with  $x(\text{CO}_2)$  between  $200\text{--}2000 \times 10^{-6}$  for use as pneumatic gas to force sea water in equilibrium with differing  $f(\text{CO}_2)$  into the calibrated volume used to deliver samples for coulometric analysis of total dissolved inorganic carbon. This approach ensures minimal loss of  $\text{CO}_2$  to the head-space in the sample bottle. It will also be used to prepare high level  $\text{CO}_2$  in air standards (1 -- 10 %) to calibrate our coulometric  $\text{CO}_2$  analysis system using gas loops. This will allow larger loop volumes to be used, which are easier to determine.

### Manometric system

The COCC manometric system is similar to the one at the Scripps Institution of Oceanography. It uses a high precision cathetometer readable to 0.002 mm Hg for mercury heights of up to 1000 mm.  $\text{CO}_2$  is extracted from either a gaseous or liquid sample, purified by sublimation to remove water using solid  $\text{CO}_2$  / liquid  $\text{N}_2$  traps, and transferred into a calibrated glass chamber. The  $\text{CO}_2$  is determined from an equation of state for  $\text{CO}_2$ . The COCC system has been shown to be compatible with the SIO system from a few measurements, but more work is needed to establish its performance.

### Feasibility study of $\text{CO}_2$ reference sea water

Storage tests have been conducted to assess the feasibility of using sea water from 2500 m depth at Ocean Station P (50°N, 145°W) as a reference material for quality assurance. Sea water was collected in 30 dm<sup>3</sup> Niskin samplers,

transferred into 15 dm<sup>3</sup> glass carboys and stored poisoned with mercuric chloride at 150 ppm in sea water. The water was aged for a long period, up to five years.

In test series #1, 20 dm<sup>3</sup> of aged sea water was filtered through a 0.4 µm polycarbonate filter, equilibrated overnight and transferred by gravity into 250 cm<sup>3</sup> or 500 cm<sup>3</sup> Pyrex glass bottles with 50 % overflow. The sub-samples were stored in these bottles sealed with greased ground glass stoppers. Air in contact with the surface of the sea water was bubbled through the same sea water in two 5 dm<sup>3</sup> glass carboys. Total dissolved inorganic carbon was determined by the extraction / coulometric procedure, calibrated using Na<sub>2</sub>CO<sub>3</sub> solutions. The results (figure III.2) indicate that the bottled sea water is stable for a prolonged period.

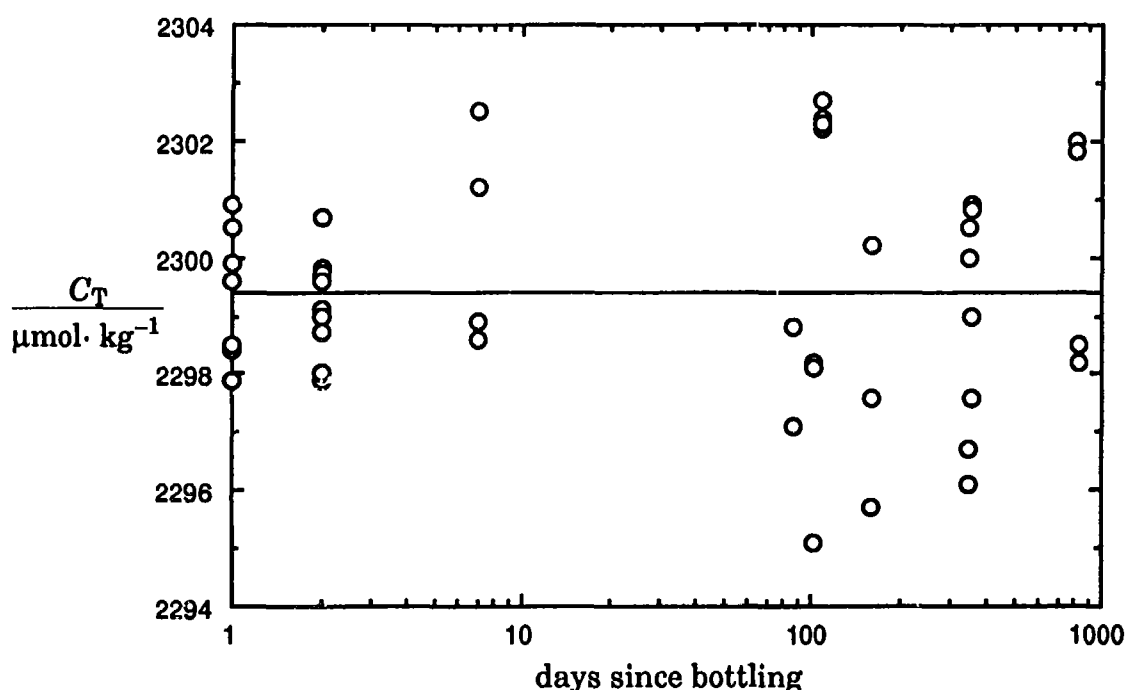

Figure III.2: Results for total dissolved inorganic carbon for test series #1. The points denote individual replicate measurements on 13 different bottles. The mean of these 46 analyses is 2299.4 µmol·kg<sup>-1</sup> with a standard deviation of 1.9 µmol·kg<sup>-1</sup>.

In test series #2, 10 carboys of aged sea water (1 – 2 years old) of 10 dm<sup>3</sup> each were filtered through a 0.4 µm polycarbonate filter into a 200 dm<sup>3</sup> polyethylene container, mixed by a polyethylene paddle with 3 vanes, and equilibrated overnight. The paddle was then removed, and the sea water covered with a close fitting but movable polyethylene plate. The sea water was again sampled into 250 cm<sup>3</sup> and 500 cm<sup>3</sup> Pyrex bottles with greased ground glass stoppers inserted after filling. A total of 158 bottles were filled. The results obtained from this series indicate an increase of about 10 µmol·kg<sup>-1</sup> over a period of about 500 days. It was later discovered that possibly 80 % of the carboys had not been poisoned, thus the samples may be subject to continuing biodegradation.

## UNESCO TECHNICAL PAPERS IN MARINE SCIENCE

### Titles of numbers which are out of stock

| No | Year  | SCOR<br>WG | No.   | Year | SCOR<br>WG  |      |       |
|----|---|------------|-------|------|---|------|-------|
| 1  | Incorporated with Nos. 4, 8 and 14 in No. 27  | 1965       | WG 10 | 18   | A review of methods used for quantitative phytoplankton studies; sponsored by SCOR, Unesco  | 1971 | WG 33 |
| 2  | Report of the first meeting of the joint group of experts on photosynthetic radiant energy held at Moscow, 5-9 October 1964. Sponsored by Unesco, SCOR and IAPO   | 1965       | WG 15 | 19   | Marine Science Teaching at the University Level. Report of the Unesco Workshop on University Curricula-Available in Spanish and Arabic  | 1974 |       |
| 3  | Report on the intercalibration measurements in Copenhagen, 9-13 June 1965. Organized by ICES  | 1966       | —     | 20   | Ichthyoplankton. Report of the ICAR Ichthyoplankton Workshop-Also published in Spanish  | 1975 | —     |
| 4  | Incorporated with Nos. 1, 8 and 14 in No. 27  | 1966       | WG 10 | 21   | An intercomparison of open sea tidal pressure sensors. Report of SCOR Working Group 27: "Tides of the open sea"   | 1975 | WG 27 |
| 5  | Report of the second meeting of the joint group of experts on photosynthetic radiant energy held at Kauizawa, 15-19 August 1966. Sponsored by Unesco, SCOR, IAPO  | 1966       | WG 15 | 22   | European sub-regional co-operation in oceanography. Report of Working Group sponsored by the Unesco Scientific Co-operation Bureau for Europe and the Division of Marine Sciences   | 1975 | —     |
| 6  | Report of a meeting of the joint group of experts on radiocarbon estimation of primary production held at Copenhagen, 24-26 October 1966. Sponsored by Unesco, SCOR, ICES   | 1967       | WG 20 | 23   | An intercomparison of some currents meters, III. Report on an experiment carried out from the Research Vessel Atlantis II, August-September 1972, by the Working Group on Continuous Velocity Measurements, sponsored by SCOR, IAPSO and Unesco | 1975 | WG 21 |
| 7  | Report of the second meeting of the Committee for the Check-List of the Fishes of the North Eastern Atlantic and on the Mediterranean, London, 20-22 April 1967   | 1968       | —     | 24   | Seventh report of the joint panel on oceanographic tables and standards, Grenoble, 2-5 September 1975; sponsored by Unesco, ICES, SCOR, IAPSO   | 1976 | WG 10 |
| 8  | Incorporated with Nos. 1, 4 and 14 in No. 27  | 1968       | WG 10 | 25   | Marine science programme for the Red Sea. Recommendations of the workshop held in Bremerhaven, FRG, 22-23 October 1974; sponsored by the Deutsche Forschungsgemeinschaft and Unesco   | 1976 | —     |
| 9  | Report on intercalibration measurements, Leningrad, 24-28 May 1966 and Copenhagen, September 1966; organized by ICES  | 1969       | —     | 26   | Marine science in the Gulf area-Report of a consultative meeting, Paris, 11-14 November 1975  | 1976 | —     |
| 10 | Guide to the Indian Ocean Biological Centre (IOBC), Cochin (India), by the Unesco Curator 1967-1969 (Dr. J. Tranter)  | 1969       | —     | 27   | Collected reports of the joint panel on oceanographic tables and standards, 1964-1969   | 1976 | WG 10 |
| 11 | An intercomparison of some current meters, report on an experiment at WHOI Mooring Site "D", 16-24 July 1967 by the Working Group on Continuous Current Velocity Measurements. Sponsored by SCOR, IAPSO and Unesco  | 1969       | WG 21 | 28   | Eighth report of the joint panel on oceanographic tables and standards, Woods Hole, U.S.A., sponsored by Unesco, ICES, SCOR, IAPSO  | 1978 | WG 10 |
| 12 | Check-List of the Fishes of the North-Eastern Atlantic and of the Mediterranean (report of the third meeting of the Committee, Hamburg, April 1969)   | 1969       | —     | 29   | Committee for the preparation of CLOFETA-Report of the first meeting, Paris, 16-18 January 1978   | 1979 | —     |
| 13 | Technical report of sea trials conducted by the working group on photosynthetic radiant energy, Gulf of California, May 1968; sponsored by SCOR, IAPSO, Unesco  | 1969       | WG 15 | 30   | Ninth report of the joint panel on oceanographic tables and standards, Unesco, Paris, 11-13 September 1978  | 1979 | —     |
| 14 | Incorporated with Nos. 1, 4 and 8 in No. 27   | 1970       | WG 10 | 32   | Coastal lagoon research, present and future. Report and guidelines of a seminar, Duke University Marine Laboratory, Beaufort, NC, U.S.A. August 1978 (Unesco, IABO)   | 1981 | —     |
| 15 | Monitoring life in the ocean, sponsored by SCOR, ACMRR, Unesco, IBP/PM  | 1973       | WG 29 | 37   | Background papers and supporting data on the Practical Salinity Scale 1978  | 1981 | WG 10 |
| 16 | Sixth report of the joint panel on oceanographic tables and standards, Kiel, 24-26 January 1973; sponsored by Unesco, ICES, SCOR, IAPSO   | 1974       | WG 10 | 50   | Progress on oceanographic tables and standards 1983-1986. Work and recommendations of the Unesco/SCOR/ICES/IAPSO Joint Panel  | 1987 | —     |
| 17 | An intercomparison of some current meters, report on an experiment of Research Vessel Akademik Kurchatov, March-April 1970, by the Working Group on Current Velocity Measurements; sponsored by SCOR, IAPSO, Unesco | 1974       | WG 21 |      |   |      |       |